

MZ-K-14/6.5 Sensor bracket

- Reliable mounting of cylinder sensors at profiled cylinders
- High locking power
- Robust metal casing
- For a quick and easy fix and mounting of sensors

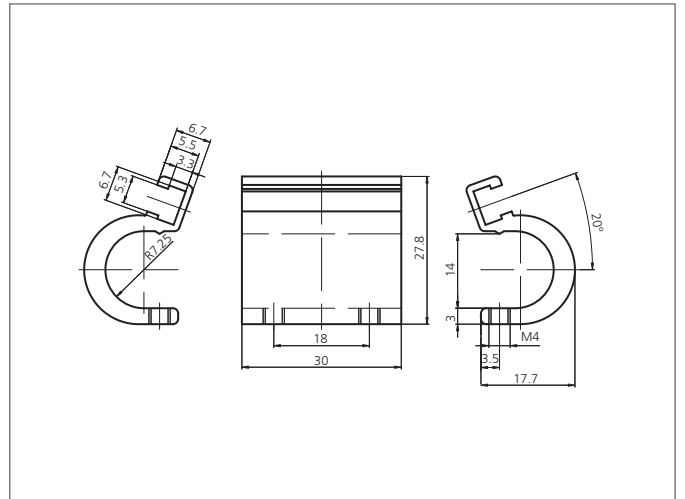
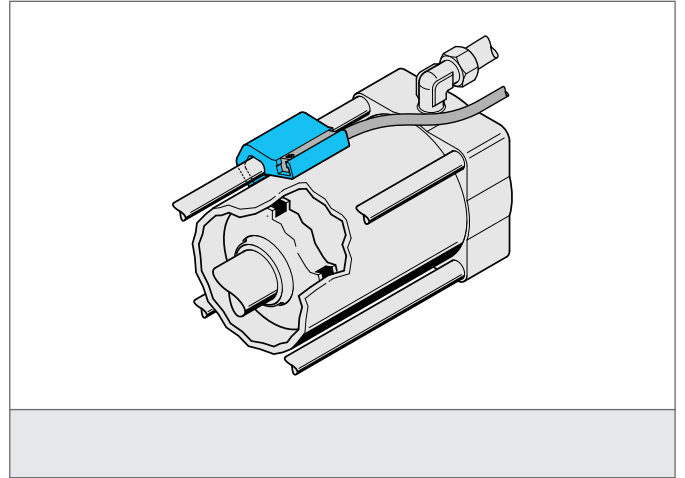

TECHNICAL INFORMATION (typ.)

Mounting	at profiled cylinders
For	Cylinder sensores with T-Slot
Casing material	Aluminium
to be used for	Piston Ø 50-63 mm
Scope of delivery	Fixing material