

SHB-S30 Sensor Holder

- Set includes adapter plate and ball joint
- Universal mounting possibility
- Smooth adjustment
- For a quick and easy fix and mounting of sensors
- Central ball joint adjustment
- Stainless steel / steel galvanized

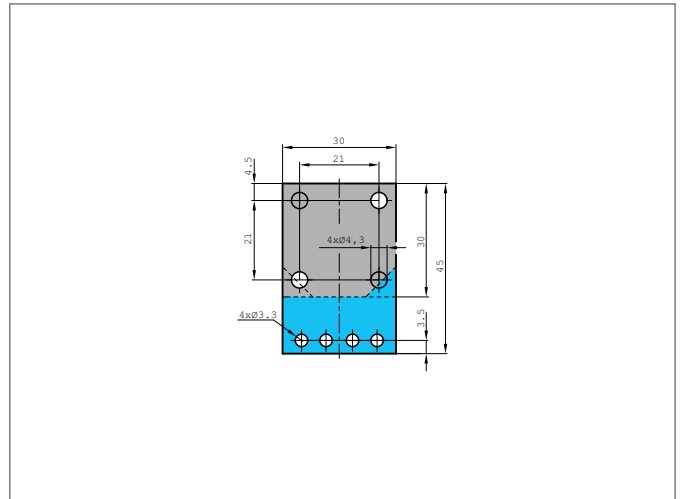
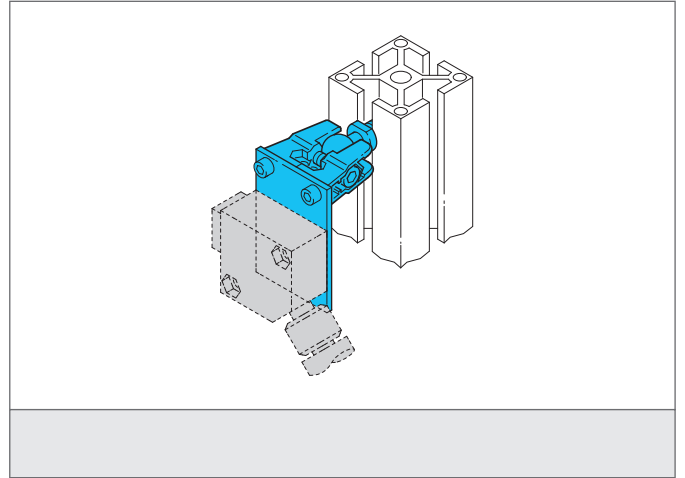

TECHNICAL INFORMATION (typ.)

Mounting	Screw mounting M6 x 10
For	Sensor size 30
Casing material	Steel galvanized