

OGUFIX 081 P2K-TSSL

Fork Light Barrier

- Quick commissioning, no setting elements
- No risk of wrong adjustments
- Value for money
- Mountable side by side
- Dark switching
- Metal casing
- High protection class
- 5-year warranty

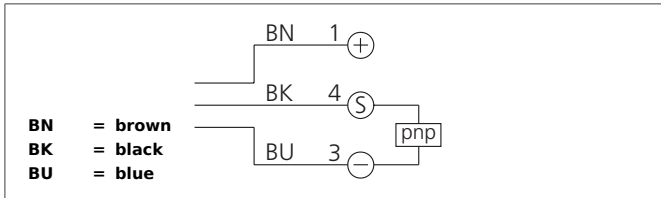

Safety instructions

The Instruments are not to be used for safety applications, in particular applications in which safety of persons depends on proper operation of the instruments.

These instruments shall exclusively be used by qualified personnel.

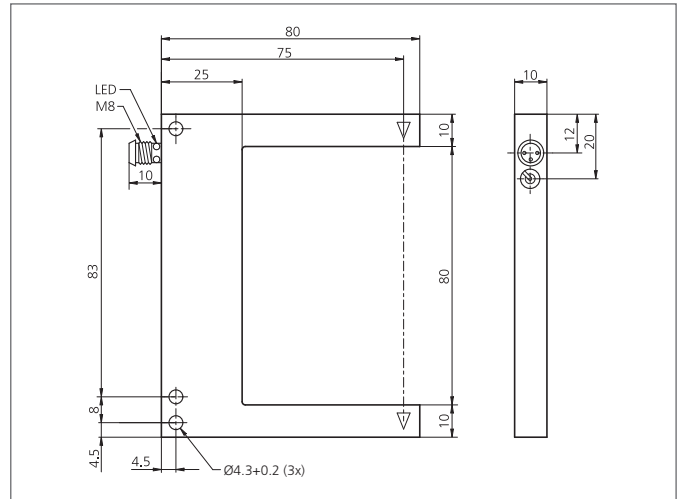

TECHNICAL INFORMATION (typ.)	+20°C, 24V DC
Operating principle	Optical
Evaluation	digital
Size	100 x 80 x 10 mm (Dimensions)
Design	fork
Fork opening	80 mm
Branch length	55 mm
Emitted light	Red, clocked
Service voltage	10 ... 35 V DC (Supply Class 2)
Internal power consumption	< 30 mA
Resolution	Ø 1,0 mm
Sensitivity adjustment	no setting elements
Switching output	pnp, 200 mA, NO
Switching hysteresis	< 0,25 mm
Voltage drop	2,8 V
Switching frequency	2.500 Hz
Reproducibility	0,06 mm
Ambient temperature	-10 ... +60 °C
Ambient light immunity	40 kLx
Insulation voltage endurance	500 V
Protection class	IP 67
Protection degree	III, operation on protective low voltage
Casing material	Die-cast zinc grey lacquered finish
Connection	Connector, M8, 3-poled

OGUFIX 081 P2K-TSSL
Fork Light Barrier



TECHNICAL INFORMATION (typ.)

+20°C, 24V DC

Connecting cable

TK ...