

OGU 051 P3K-TSSL/V4A

Fork Light Barrier

- Robust stainless steel casing for use in the pharma, beverage and food industry
- Integrated electronic module
- Sensitivity adjustable
- High operating frequency
- Light / dark switching
- Bright ring LED
- High protection class
- 5-year warranty

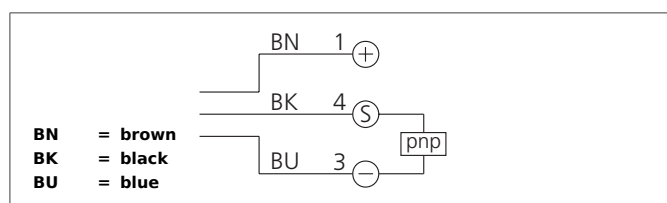

Safety instructions

The Instruments are not to be used for safety applications, in particular applications in which safety of persons depends on proper operation of the instruments.

These instruments shall exclusively be used by qualified personnel.

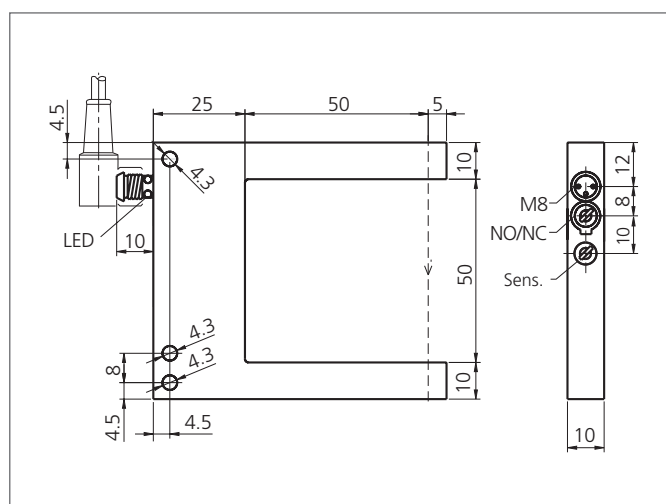

TECHNICAL INFORMATION (typ.)	+20°C, 24V DC
Operating principle	Optical
Evaluation	digital
Size	70 x 80 x 10 mm (Dimensions)
Design	fork
Fork opening	50 mm
Branch length	55 mm
Emitted light	Red, 660 nm, clocked
Service voltage	10 ... 35 V DC (Supply Class 2)
Internal power consumption	< 30 mA
Resolution	Ø 0,5 mm
Sensitivity adjustment	potentiometer
Switching output	pnp, 200 mA, NO/NC, switchable
Switching hysteresis	< 0,25 mm
Voltage drop	2,8 V
Switching frequency	4.000 Hz
Reproducibility	0,04 mm
Ambient temperature	-10 ... +60 °C
Ambient light immunity	40 kLx
Insulation voltage endurance	500 V
Protection class	IP 67
Protection degree	III, operation on protective low voltage
Casing material	stainless steel V4A, (1.4404 / AISI 316L - 1.4571 / AISI 316Ti)
Connection	Connector, M8, 3-poled

OGU 051 P3K-TSSL/V4A
Fork Light Barrier



TECHNICAL INFORMATION (typ.)

+20°C, 24V DC

Connecting cable

TK ...