

OTV Q5 M 20 P1LK Diffuse Sensor

- Extrem small design
- Infrared light
- High resolution
- Functional reserve
- Insensitive to dirt
- High protection class

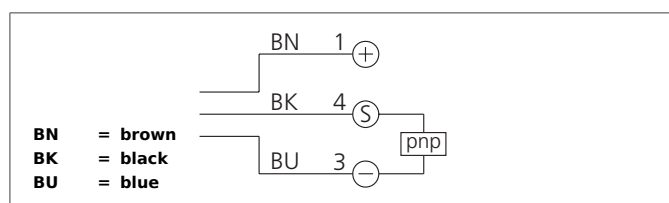

Safety instructions

The Instruments are not to be used for safety applications, in particular applications in which safety of persons depends on proper operation of the instruments.

These instruments shall exclusively be used by qualified personnel.

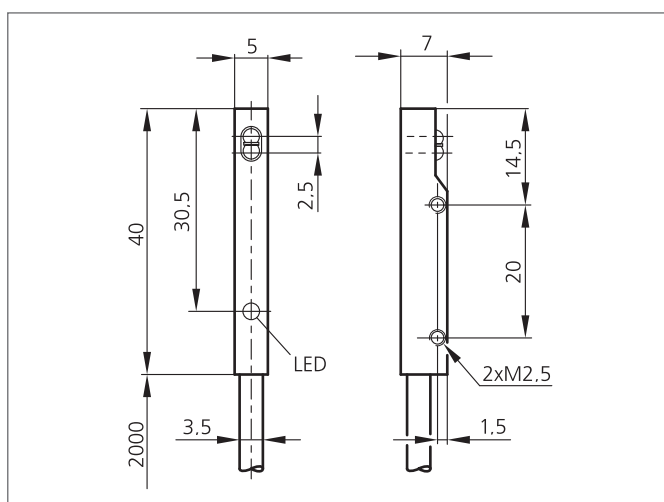

TECHNICAL INFORMATION (typ.)		+20°C, 24V DC
Operating principle		Diffuse reflective sensor
Evaluation		digital
Size		5 x 7 x 40 mm (Dimensions)
Design		cuboid design
Emitted light		Infrared, 880 nm, clocked
Standardized measuring plate		100 x 100 mm, white
Service voltage		10 ... 30 V DC
Internal power consumption		< 15 mA
background suppression		no
Operating distance		20 mm
Sensitivity adjustment		no setting elements
Switching output		pnp, 100 mA, NO
Switching hysteresis		< 10 %
Voltage drop		< 2,0 V
Switching frequency		250 Hz
Response-/release time		< 2,5 ms / < 2,5 ms
Ambient temperature		-25 ... +55 °C
Ambient light immunity		10 kLx
Insulation voltage endurance		500 V
Protection class		IP 67
Protection degree		III, operation on protective low voltage
Casing material		stainless steel V2A (1.4301 / AISI 304)
Connection		cable PVC, 2 m