

OGU 021 N3K-TSSL

Fork Light Barrier

- Metal casing
- Integrated electronic module
- Sensitivity adjustable
- High operating frequency
- Light / dark switching
- Bright ring LED
- High protection class
- 5-year warranty

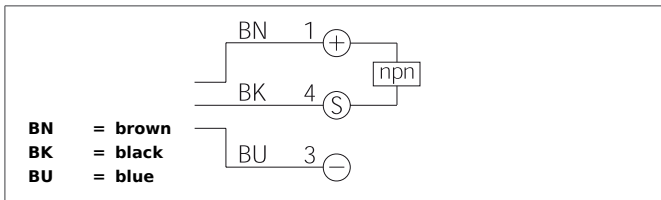

Safety instructions

The Instruments are not to be used for safety applications, in particular applications in which safety of persons depends on proper operation of the instruments.
 These instruments shall exclusively be used by qualified personnel.

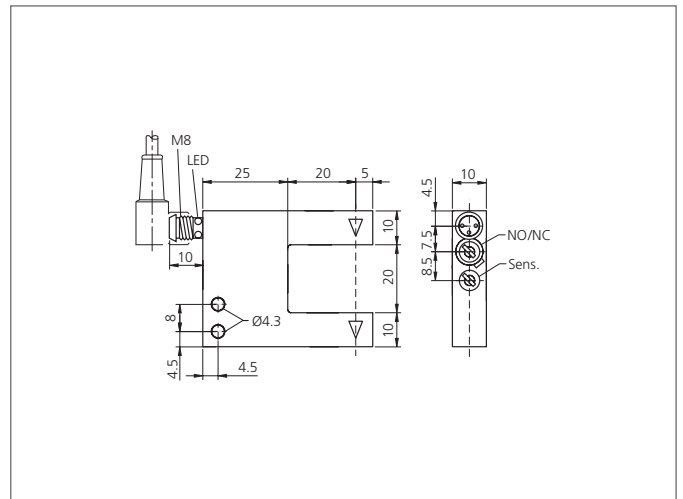

TECHNICAL INFORMATION (typ.)	+20°C, 24V DC
Operating principle	Optical
Evaluation	digital
Size	40 x 50 x 10 mm (Dimensions)
Design	fork
Fork opening	20 mm
Branch length	25 mm
Emitted light	Red, clocked
Service voltage	10 ... 35 V DC (Supply Class 2)
Internal power consumption	< 30 mA
Resolution	Ø 0,4 mm
Sensitivity adjustment	potentiometer
Switching output	npn, 200 mA, NO/NC, switchable
Switching hysteresis	< 0,1 mm
Voltage drop	2,8 V
Switching frequency	4.000 Hz
Reproducibility	0,02 mm
Ambient temperature	-10 ... +60 °C
Ambient light immunity	40 kLx
Insulation voltage endurance	500 V
Protection class	IP 67
Protection degree	III, operation on protective low voltage
Casing material	Die-cast zinc black lacquered finish
Connection	Connector, M8, 3-poled

OGU 021 N3K-TSSL
Fork Light Barrier



TECHNICAL INFORMATION (typ.)

+20°C, 24V DC

Connecting cable

TK ...