

LGUP 121 P3K-TSSL/V4A

Laser Fork Light Barrier

- Resolution 0,2 mm
- Visible laser spot
- High operating frequency
- Light / dark switching
- Stainless steel casing
- Laser class 1
- High protection class
- Extremely bright ring LED
- 5-year warranty



Safety instructions

Inproper use may result in hazardous radiation exposure. Pay attention to accident prevention rules and laser class. The instruments are not to be used for safety applications, in particular applications in which safety of persons depends on proper operation of the instruments. These instruments shall exclusively be used by qualified personnel.

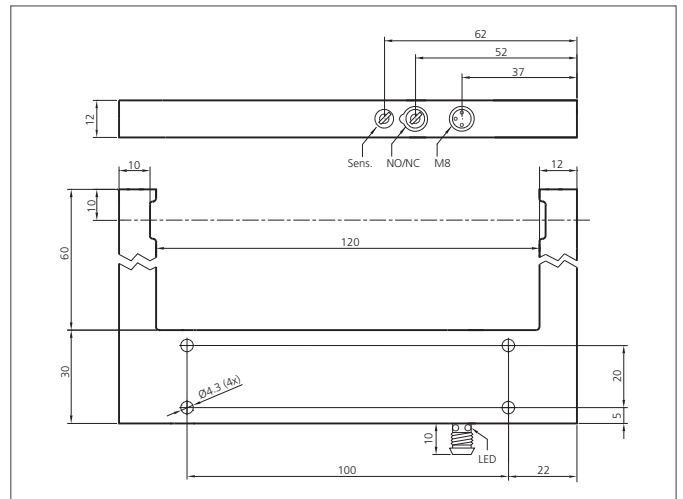

TECHNICAL INFORMATION (typ.)	+20°C, 24V DC
Operating principle	Optical
Evaluation	digital
Size	144 x 90 x 12 mm (Dimensions)
Design	fork
Fork opening	120 mm
Branch length	60 mm
Emitted light	Red light laser, clocked
Laser class	1 (IEC 60825-1)
Service voltage	10 ... 35 V DC (Supply Class 2)
Internal power consumption	< 30 mA
Resolution	Ø 0,2 mm
Sensitivity adjustment	potentiometer
Switching output	pnp, 200 mA, NO/NC, switchable
Switching hysteresis	< 0,05 mm
Voltage drop	< 2,8 V
Switching frequency	3.000 Hz
Reproducibility	0,02 mm
Laser power	< 100 µW
Ambient temperature	0 ... +50 °C
Ambient light immunity	5 kLx
Insulation voltage endurance	500 V
Protection class	IP 67
Protection degree	III, operation on protective low voltage

LGUP 121 P3K-TSSL/V4A Laser Fork Light Barrier



TECHNICAL INFORMATION (typ.)	+20°C, 24V DC
Casing material	stainless steel V4A, (1.4404 / AISI 316L - 1.4571 / AISI 316Ti)
Connection	Connector, M8, 3-poled
Connecting cable	TK ...