

DCC 12 M 04 NOLK Inductive Proximity Switch

- Cable, highly flexible
- Integrated amplifier
- Short-circuit protection
- Starting pulse suppression
- LED



Safety instructions

The Instruments are not to be used for safety applications, in particular applications in which safety of persons depends on proper operation of the instruments.

These instruments shall exclusively be used by qualified personnel.

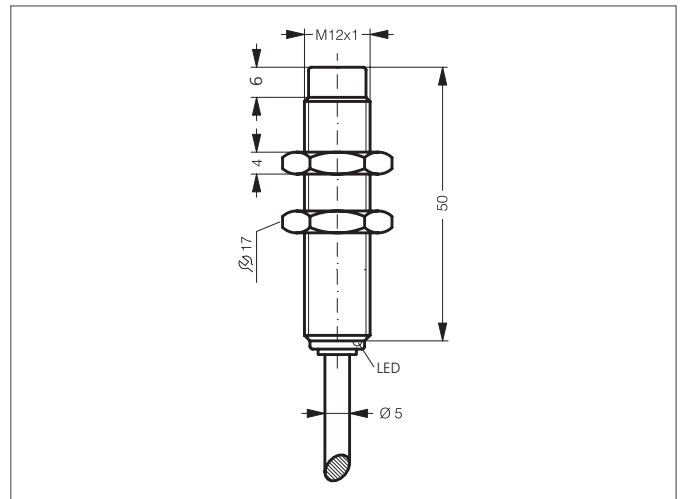

TECHNICAL INFORMATION (typ.)	+20°C, 24V DC
Operating principle	Inductive
Evaluation	digital
Size	M12 x 1 (thread)
Design	screw
Mounting	non-flush
Operating distance	4 mm
Standardized measuring plate	12 x 12 x 1 mm
Service voltage	10 ... 30 V DC
Internal power consumption	< 10 mA
Switching output	npn, 200 mA, NC
Switching hysteresis	10 %
Voltage drop	< 2,0 V
Switching frequency	2.000 Hz
Ambient temperature	-25 ... +70 °C
Insulation voltage endurance	500 V
Protection class	IP 67
Casing material	brass
Connection	cable PVC, 2 m