

LA-D 32-25-775-960 I-H

Light Curtain

- Diagonal beam evaluation
- Integrated evaluation electronics
- Transistor outputs
- Fault alarm output
- Compact design
- Aluminium casing
- Easy-to-install

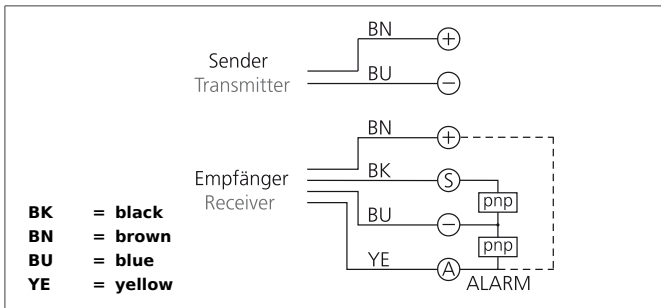

Safety instructions

The Instruments are not to be used for safety applications, in particular applications in which safety of persons depends on proper operation of the instruments.

These instruments shall exclusively be used by qualified personnel.

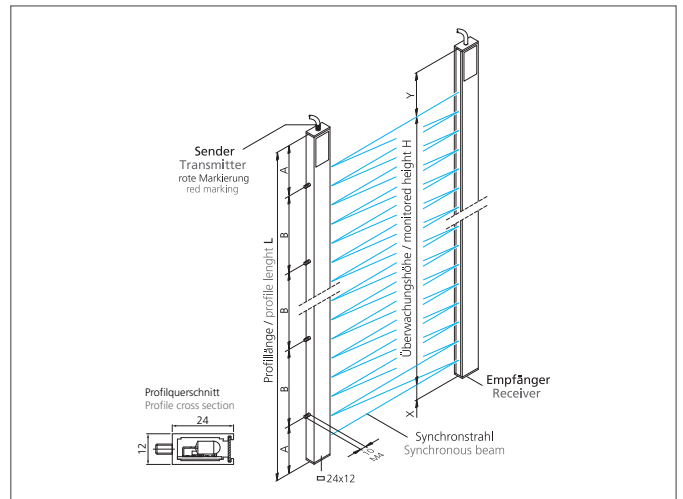

TECHNICAL INFORMATION (typ.)		+20°C, 24V DC
Evaluation		diagonal
Size		12 x 24 mm (Profile cross section)
Light beam interspace		25 mm
Number of beams		32
Monitored height		775 mm
Number		3 (threaded bolts)
Dimension		80 mm (A) 400 mm (B) 20 mm (X) 160 mm (Y)
Profile length		960 mm
Emitted light		Infrared, 880 nm
Service voltage		20,4 ... 28,8 V DC
Operating distance		0,7 ... 4 m factory setting
Light beam evaluation		up to integrated evaluation electronics
Switching output		pnp, 200 mA, NC, short circuit protected
Total cycle time		Number of light beams x 1 ms + 4 ms
Evaluation electronics		integrated
Cycle time		1 ms per light beam
Power consumption		8 W
Display		LED: Service voltage / output stage, error (Alarm)
Basic processing time		4 ms
Ambient temperature		-10 ... +45 °C
Protection class		IP 54, (IP 65 optional)

LA-D 32-25-775-960 I-H
Light Curtain



TECHNICAL INFORMATION (typ.)	+20°C, 24V DC
EMC directives	EN 61000-6-3:2001 / EN 61000-6-1:2001
Casing material	Aluminium silver anodized
Connection	Cable, 4 m, with end splice