

LI 16-25-375-440 I

Light Curtain

- With evaluation electronics LVE ... / LVX ... measuring and switching
- With evaluation electronics LVB ... switching
- Beam evaluation horizontal or diagonal
- Compact design
- Aluminium casing
- Easy-to-install

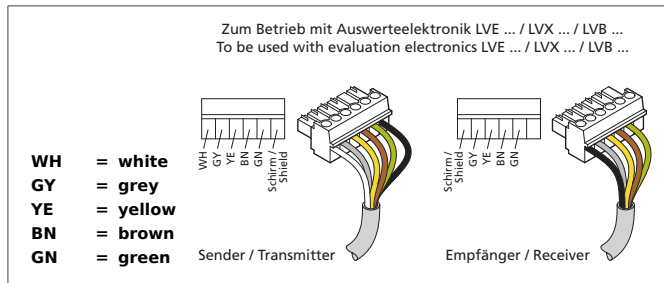
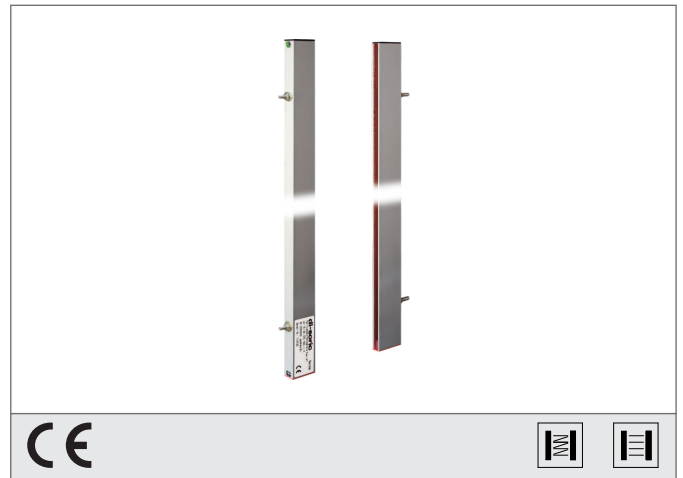

Safety instructions

The Instruments are not to be used for safety applications, in particular applications in which safety of persons depends on proper operation of the instruments.
These instruments shall exclusively be used by qualified personnel.

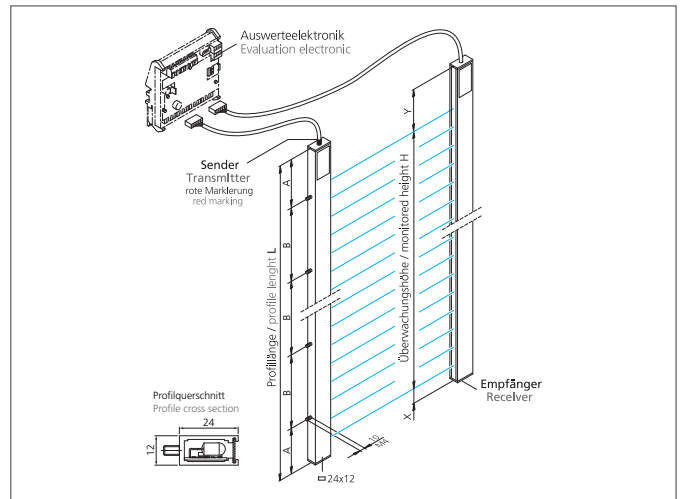

TECHNICAL INFORMATION (typ.)	+20°C, 24V DC
Evaluation	absolute, percentage, parametrizable via evaluation electronics
Size	12 x 24 mm (Profile cross section)
Light beam interspace	25 mm
Number of beams	16
Monitored height	375 mm
Number	2 (threaded bolts)
Output function	parametrizable via evaluation electronics
Dimension	70 mm (A) 300 mm (B) 20 mm (X) 45 mm (Y)
Profile length	440 mm
Emitted light	Infrared, 880 nm
Service voltage	20 ... 26 V DC (see evaluation electronics)
Operating distance	0,25 ... 6 m adjustable via evaluation electronics
Light beam evaluation	via external evaluation electronics
Measuring range	375 mm
Switching output	NC, NO, parametrizable via evaluation electronics
Evaluation electronics	external
Ambient temperature	-20 ... +40 °C
Protection class	IP 54, (IP 65 optional)
Casing material	Aluminium nature
Connection	Cable, 4 m, with connector, (additional variants on request)