

LA-D 64-25-1575-1760 I-D

Light Curtain

- Diagonal beam evaluation
- Integrated evaluation electronics
- Transistor outputs
- Fault alarm output
- Compact design
- Aluminium casing
- Easy-to-install

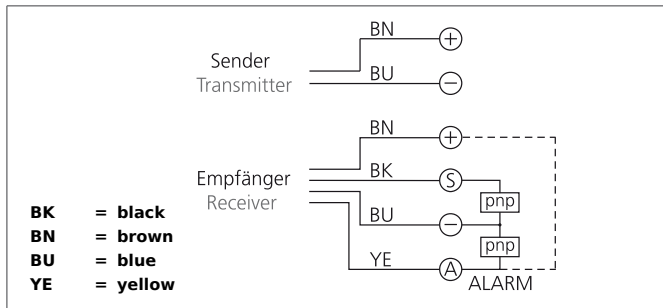

Safety instructions

The Instruments are not to be used for safety applications, in particular applications in which safety of persons depends on proper operation of the instruments.

These instruments shall exclusively be used by qualified personnel.

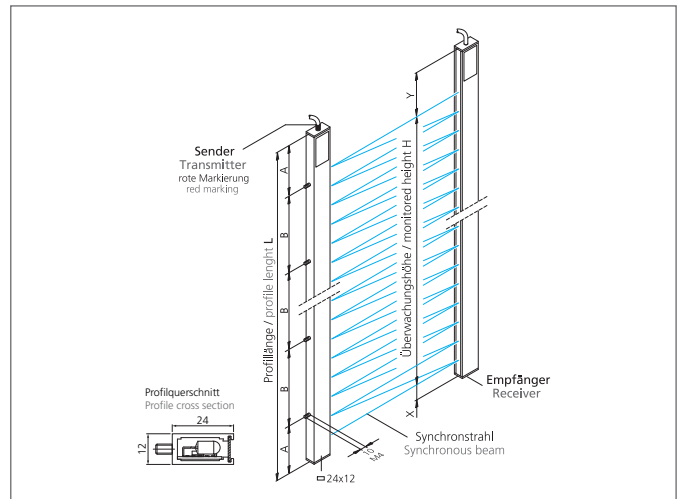

TECHNICAL INFORMATION (typ.)	+20°C, 24V DC
Evaluation	diagonal
Size	12 x 24 mm (Profile cross section)
Light beam interspace	25 mm
Number of beams	64
Monitored height	1575 mm
Number	4 (threaded bolts)
Dimension	130 mm (A) 500 mm (B) 20 mm (X) 160 mm (Y)
Profile length	1760 mm
Emitted light	Infrared, 880 nm
Service voltage	20,4 ... 28,8 V DC
Operating distance	0,7 ... 4 m factory setting
Light beam evaluation	up to integrated evaluation electronics
Switching output	pnp, 200 mA, NO, short circuit protected
Total cycle time	Number of light beams x 1 ms + 4 ms
Evaluation electronics	integrated
Cycle time	1 ms per light beam
Power consumption	8 W
Display	LED: Service voltage / output stage, error (Alarm)
Basic processing time	4 ms
Ambient temperature	-10 ... +45 °C
Protection class	IP 54, (IP 65 optional)

LA-D 64-25-1575-1760 I-D
Light Curtain



TECHNICAL INFORMATION (typ.)	+20°C, 24V DC
EMC directives	EN 61000-6-3:2001 / EN 61000-6-1:2001
Casing material	Aluminium silver anodized
Connection	Cable, 4 m, with end splice