

O-C2-S-08-14

Lens

- Compact design
- Lock screws for focus and iris adjustment
- Filters attachable
- High resolution



Safety instructions

The Instruments are not to be used for safety applications, in particular applications in which safety of persons depends on proper operation of the instruments.
 These instruments shall exclusively be used by qualified personnel.

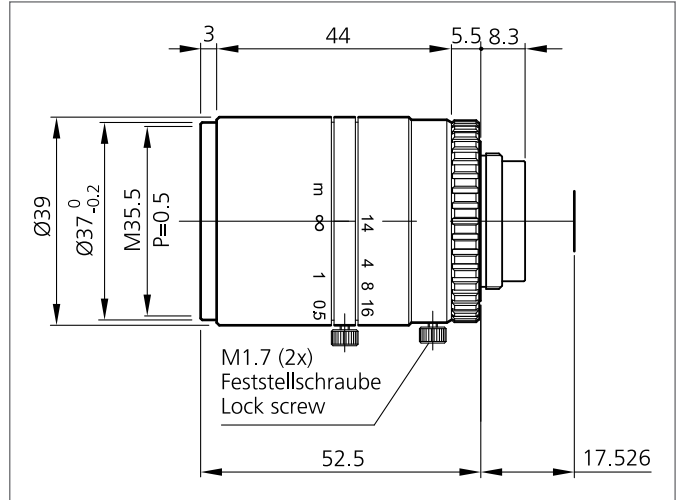

TECHNICAL INFORMATION (typ.)		+20°C
Resolution		up to 3 megapixel
For		Vision Systems and ID Systems
Focal length		8 mm
Aperture (F)		1.4
Working distance WD		100 mm
Screw thread		C-Mount
Filter thread		M35.5 x 0.5
Sensor size		max. 2/3"
Weight		125 g