

O-POL-35

Polarizer with locking screw

- For reduction of mirroring and reflections in conjunction with polarized light
- Real-glass filter
- Integrated locking screw
- Housing made of black anodized aluminium

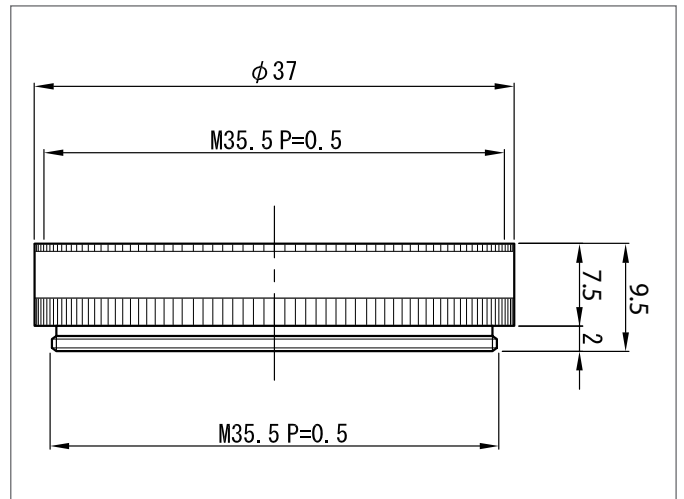

TECHNICAL INFORMATION (typ.)

Size	Ø 37 mm (Diameter)
Characteristics	Mounting thread for additional filter
Material	Aluminium (Filter thread) Glass (Filter)
Filter thread	M35.5 x 0.5