

## O-POL-40

### Polarizer with locking screw

- For reduction of mirroring and reflections in conjunction with polarized light
- Real-glass filter
- Integrated locking screw
- Housing made of black anodized aluminium

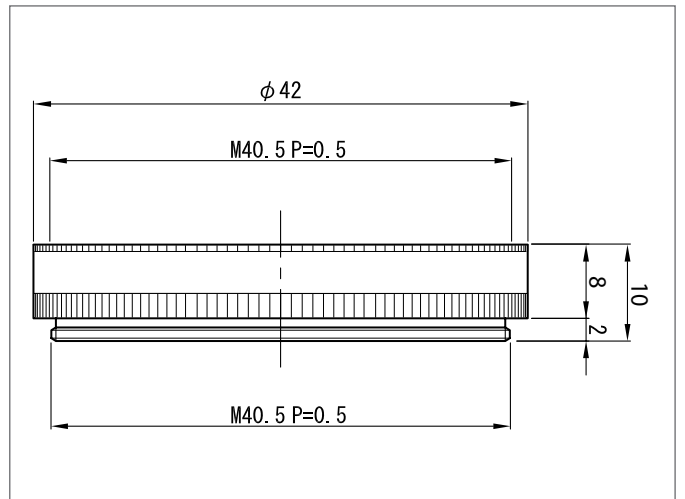

#### TECHNICAL INFORMATION (typ.)

|                 |   |
|-----------------|---|
| Size            | Ø 42 mm (Diameter)                          |
| Characteristics | Mounting thread for additional filter       |
| Material        | Aluminium (Filter thread)<br>Glass (Filter) |
| Filter thread   | M40.5 x 0.5                                 |