

# OT 18 FMR 600 P3-B4

## Diffuse Sensor

- Angled optics
- Universal mounting possibility
- Low installation depth
- Sensitivity adjustable
- LED indicator for output state
- Metal casing

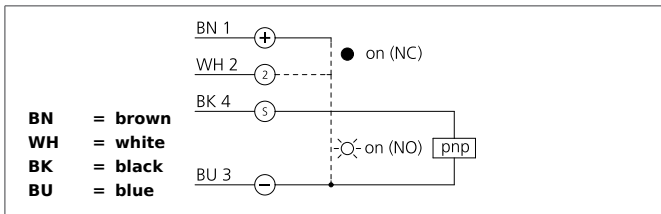

### Safety instructions

The Instruments are not to be used for safety applications, in particular applications in which safety of persons depends on proper operation of the instruments.  
 These instruments shall exclusively be used by qualified personnel.

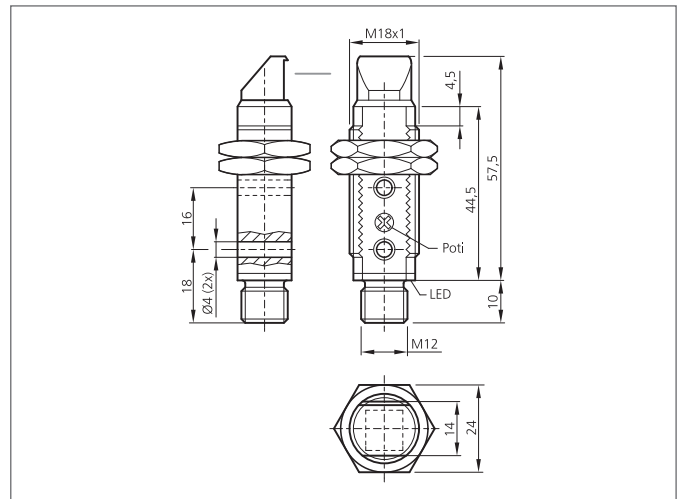

TECHNICAL INFORMATION (typ.)		+20°C, 24V DC
Operating principle		Diffuse reflective sensor
Evaluation		digital
Size		M18 x 1 (thread)
Design		screw
Emitted light		Infrared, 880 nm, clocked
Standardized measuring plate		200 x 200 mm
Service voltage		10 ... 30 V DC
Internal power consumption		30 mA
background suppression		no
Operating distance		600 mm
Sensitivity adjustment		potentiometer
Switching output		pnp, 100 mA, NO/NC
Switching frequency		1.000 Hz
Response-/release time		0,5 ms / < 0,5 ms
Ambient temperature		-25 ... +55 °C
Ambient light immunity		3 kLx, clocked light, > 10 kLx, Sunlight
Protection class		IP 67
Protection degree		III, operation on protective low voltage
Casing material		metal
Material		polymethyl methacrylate (Window)
Connection		Connector, M12, 4-poled