

SLBH4-1053

Safety light curtain

- Highest safety level
- Resolution for hand protection
- High operating distance for large systems and applications with deflecting mirrors
- Protection area until end of profile
- Parameterisation via connecting cable
- Easy and fast startup
- Automatic Start/Restart
- For Modular Safety Controller / safety relays
- Unshielded connecting cables to 100 m
- High protection class

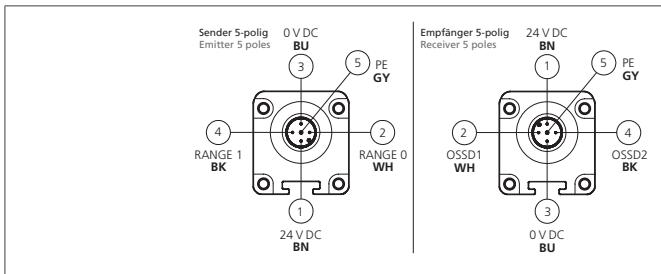
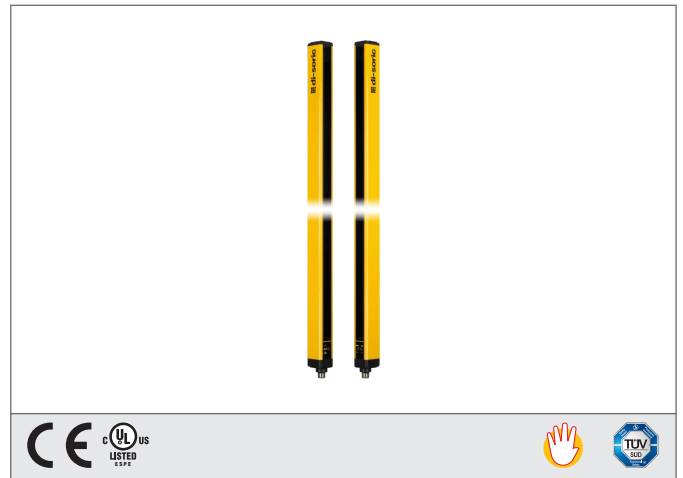

Safety instructions

All the installation, connection and safety regulations, as per our technical information, have to be strictly adhered to. The set-up of the products have to be made by skilled staff, only. Repair exclusively made by di-soric.

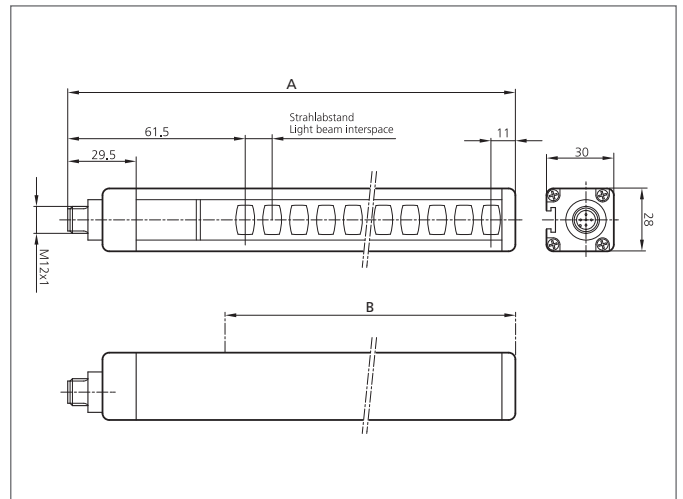

TECHNICAL INFORMATION (typ.)	+20°C, 24 V DC
Safety level	Type 4 (IEC/TS 61496-2), SIL 3 (IEC 61508), SILCL 3 (IEC 62061), PL e - Cat. 4 (EN ISO 13849-1)
Security level	Hand detection
Total height (A)	1.113 mm
Protective field height (B)	1.060 mm
Model	Basic, extended range
Mounting	T-shaped slot (Backside), / Holder SFB E 180 (optional)
Number of beams	53
Emitted light	Infrared, 950 nm
Safety output	PNP (2x), 400 mA / 24 V DC
Service voltage	19,2 ... 28,8 V DC
Operating distance	10 m (Low Range) / 20 m (High Range)
Resolution	30 mm
Inverse polarity protection	Yes
Display	LEDs for light curtain's status and diagnostic
Start / restart	Automatic
Short-circuit protection	yes
Reaction time	8,5 ms
Ambient temperature	-20 ... +55 °C
Protection class	IP 65, IP 67
Protection degree	III, operation on protective low voltage
Casing material	Aluminium
Material	polycarbonate (Window)

SLBH4-1053 Safety light curtain



TECHNICAL INFORMATION (typ.)	+20°C, 24 V DC
Connection	M12, 5-poled for transmitter and receiver, Connector
Cable	unshielded connection cables max. 100 m
Scope of delivery	Emitter + receiver, one set of standard fixing brackets SA 4, CD-ROM containing the multi-language instruction manual, quick installation guide