

SLI4-1501-WTHF

Safety light curtain in IP 69K protective housing

- Highest safety level
- Resolution for finger protection
- Heating function for low-temperature applications
- Light curtain integrated in protective enclosure - protection class IP 69K
- For use in the beverage and food industry
- Avoiding of condensate by GORE-valve
- ECOLAB approval
- Integrated safety function - no external safety relay required
- Parameterisation via connecting cable
- Selectable manual or automatic Start/Restart
- Feedback input for external relay monitoring (EDM)

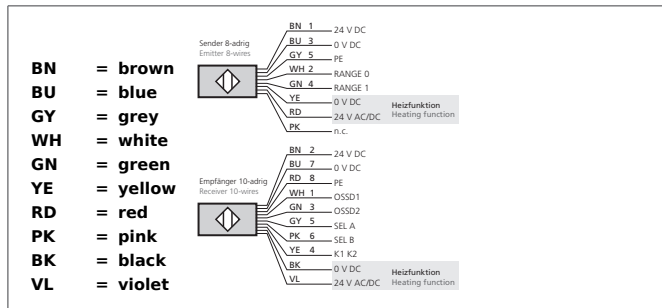

Safety instructions

All the installation, connection and safety regulations, as per our technical information, have to be strictly adhered to. The set-up of the products have to be made by skilled staff, only. Repair exclusively made by di-soric.

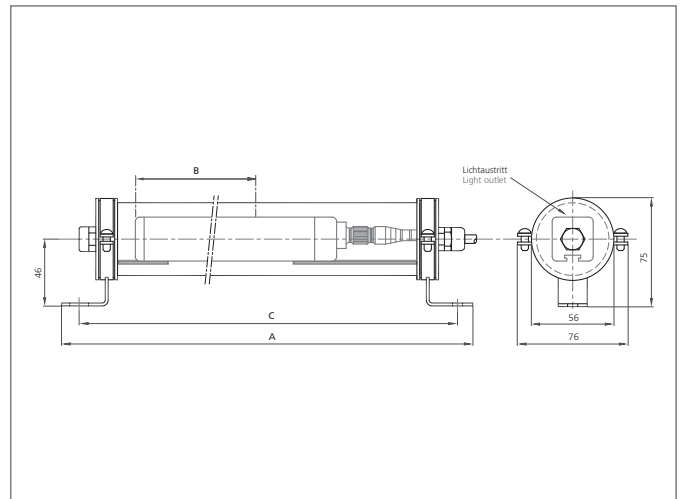

TECHNICAL INFORMATION (typ.)	+20°C, 24 V DC
Safety level	Type 4 (IEC/TS 61496-2), SIL 3 (IEC 61508), SILCL 3 (IEC 62061), PL e - Cat. 4 (EN ISO 13849-1)
Security level	Finger detection
Total height (A)	1.687 mm
Protective field height (B)	1.510 mm
Hole spacing	1.665 mm (C), ± 3 mm
Model	built-in control functions (EDM)
Models in enclosure	Watertight 80 bar and heated
Mounting	POM-C and stainless steel fastening brackets (AISI 316L)
Number of beams	150
Emitted light	Infrared, 950 nm
Safety output	PNP (2x), 400 mA / 24 V DC
Service voltage	19,2 ... 28,8 V DC
Power consumption with heating	30,2 W, (24 V DC)
Operating distance	2 m (Low Range) / 5 m (High Range)
Resolution	14 mm
Inverse polarity protection	Yes
Display	LEDs for light curtain's status and diagnostic
Start / restart	Automatic / manual (selectable)
External Device Monitoring - EDM	Feedback input, enabling selectable
Short-circuit protection	yes
Reaction time	20 ms
Ambient temperature	-25 ... +55 °C

SLI4-1501-WTHF

Safety light curtain in IP 69K protective housing

TECHNICAL INFORMATION (typ.)	+20°C, 24 V DC
Protection class	IP 69K
Protection degree	III, operation on protective low voltage
Casing material	Aluminium
Material	polycarbonate (Window)
Material enclosure	PMMA enclosure (polymethyl methacrylate), POM-C sealing caps (acetal resin - DELRIN), GORE valve
Connection	pre-wired with cable gland, 10 m cable
Cable	8-wires transmitter, 10-wires receiver, flying leads
Scope of delivery	Emitter + receiver, CD-ROM containing the multi-language instruction manual, quick installation guide, POM-C and stainless steel fastening brackets