

## SLI4-2B-S Safety light grid

- Highest safety level
- Light beam interspace for access control
- Combination of different resolutions and protective field heights
- Up to three monitoring areas
- Only one safety module / two relays required for evaluation
- Simplified cabling via series connection
- Unshielded cable connections
- Cable connection Master / Slave 2 / Slave up to 50 m
- High protection class

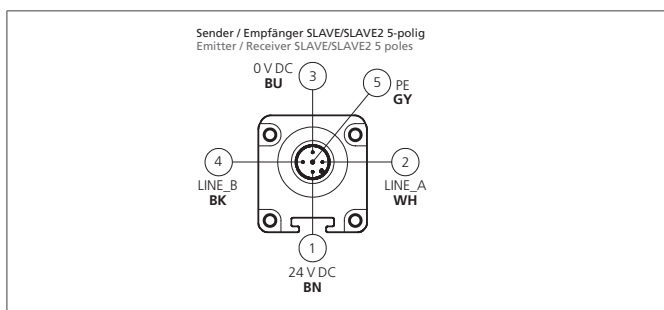

### Safety instructions

All the installation, connection and safety regulations, as per our technical information, have to be strictly adhered to. The set-up of the products have to be made by skilled staff, only. Repair exclusively made by di-soric.

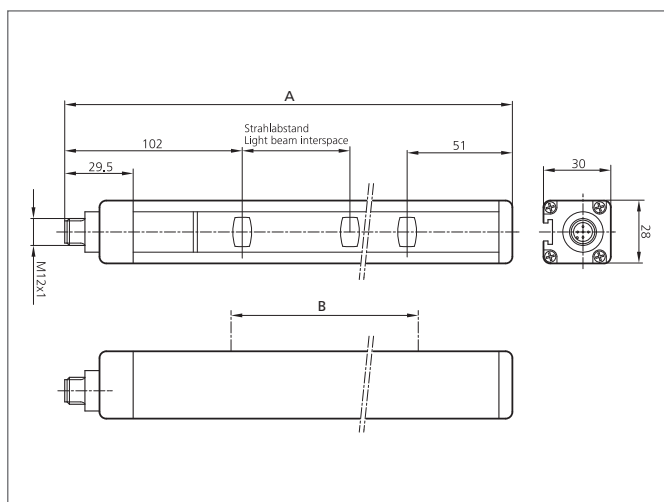

TECHNICAL INFORMATION (typ.)	+20°C, 24 V DC
Safety level	Type 4 (IEC/TS 61496-2), SIL 3 (IEC 61508), SILCL 3 (IEC 62061), PL e - Cat. 4 (EN ISO 13849-1)
Security level	Access control
Total height (A)	653 mm
Protective field height (B)	510 mm
Model	built-in control functions (EDM), Slave
Mounting	T-shaped slot (Backside), / Holder SFB E 180 (optional)
Light beam interspace	500 mm
Number of beams	2
Emitted light	Infrared, 950 nm
Service voltage	19,2 ... 28,8 V DC
Operating distance	4 m (Low Range) / 12 m (High Range)
Inverse polarity protection	Yes
Display	LEDs for light curtain's status and diagnostic
Short-circuit protection	yes
Reaction time	calculation formula
Ambient temperature	-20 ... +55 °C
Protection class	IP 65, IP 67
Protection degree	III, operation on protective low voltage
For	Operating with Master or Master / Slave 2
Casing material	Aluminium
Material	polycarbonate (Window)
Connection Master / Slave 2 / Slave	Connector, M12, 5-poled for transmitter and receiver

## SLI4-2B-S Safety light grid



TECHNICAL INFORMATION (typ.)	+20°C, 24 V DC
Cable	unshielded connecting cables Master / Slave 2 / Slave max. 50 m
Scope of delivery	Emitter + receiver, one set of standard fixing brackets SA 4, CD-ROM containing the multi-language instruction manual, quick installation guide