

SLIH4-1503-WTF

Safety light curtain in IP 69K protective housing

- Highest safety level
- Resolution for hand protection
- High operating distance for large systems
- Light curtain integrated in protective enclosure - protection class IP 69K
- For use in the beverage and food industry
- Avoiding of condensate by GORE-valve
- ECOLAB approval
- Integrated safety function - no external safety relay required
- Parameterisation via connecting cable
- Selectable manual or automatic Start/Restart
- Feedback input for external relay monitoring (EDM)

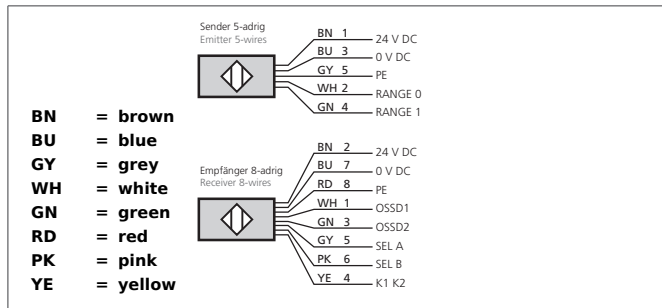

Safety instructions

All the installation, connection and safety regulations, as per our technical information, have to be strictly adhered to.
The set-up of the products have to be made by skilled staff, only.
Repair exclusively made by di-soric.

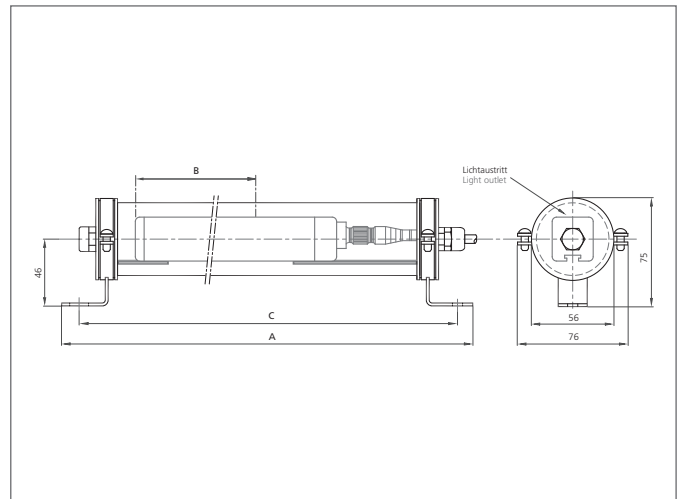

TECHNICAL INFORMATION (typ.)	+20°C, 24 V DC
Safety level	Type 4 (IEC/TS 61496-2), SIL 3 (IEC 61508), SILCL 3 (IEC 62061), PL e - Cat. 4 (EN ISO 13849-1)
Security level	Hand detection
Total height (A)	1.687 mm
Protective field height (B)	1.510 mm
Hole spacing	1.665 mm (C), ± 3 mm
Model	built-in control functions (EDM), extended range
Models in enclosure	Watertight 80 bar
Mounting	POM-C and stainless steel fastening brackets (AISI 316L)
Number of beams	76
Emitted light	Infrared, 950 nm
Safety output	PNP (2x), 400 mA / 24 V DC
Service voltage	19,2 ... 28,8 V DC
Operating distance	8 m (Low Range) / 17 m (High Range)
Resolution	30 mm
Inverse polarity protection	Yes
Display	LEDs for light curtain's status and diagnostic
Start / restart	Automatic / manual (selectable)
External Device Monitoring - EDM	Feedback input, enabling selectable
Short-circuit protection	yes
Reaction time	11 ms
Ambient temperature	-10 ... +55 °C
Protection class	IP 69K

SLIH4-1503-WTF

Safety light curtain in IP 69K protective housing

TECHNICAL INFORMATION (typ.)	+20°C, 24 V DC
Protection degree	III, operation on protective low voltage
Casing material	Aluminium
Material	polycarbonate (Window)
Material enclosure	PMMA enclosure (polymethyl methacrylate), POM-C sealing caps (acetal resin - DELRIN), GORE valve
Connection	pre-wired with cable gland, 10 m cable
Cable	5-wires transmitter, 8-wires receiver, flying leads
Scope of delivery	Emitter + receiver, CD-ROM containing the multi-language instruction manual, quick installation guide, POM-C and stainless steel fastening brackets