

SLIH4-1809

Safety light curtain

- Highest safety level
- Resolution for body protection and presence control
- High operating distance for large systems and applications with deflecting mirrors
- Protection area until end of profile
- Integrated safety function - no external safety relay required
- Parameterisation via connecting cable
- Selectable manual or automatic Start/Restart
- Feedpack input for external relay monitoring (EDM)
- Unshielded connecting cables to 100 m
- High protection class

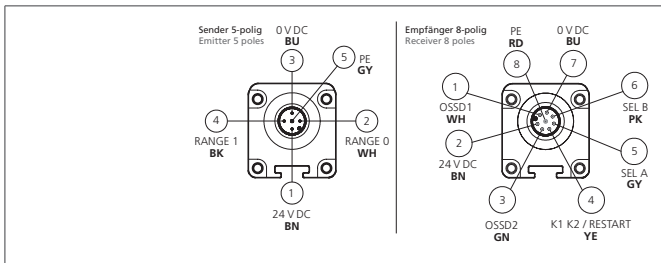
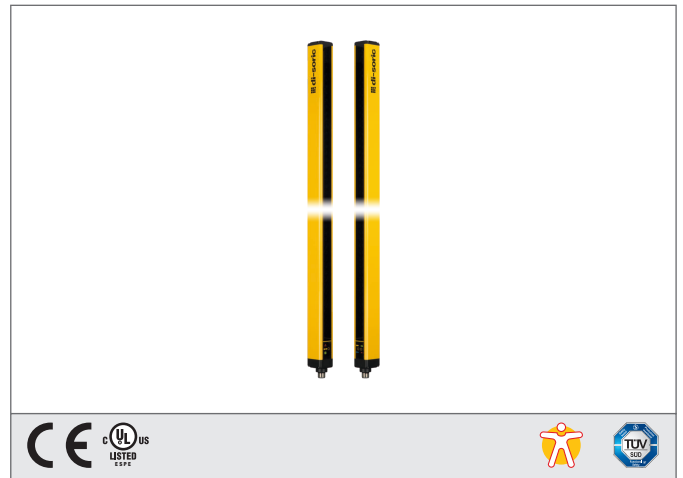

Safety instructions

All the installation, connection and safety regulations, as per our technical information, have to be strictly adhered to. The set-up of the products have to be made by skilled staff, only. Repair exclusively made by di-soric.

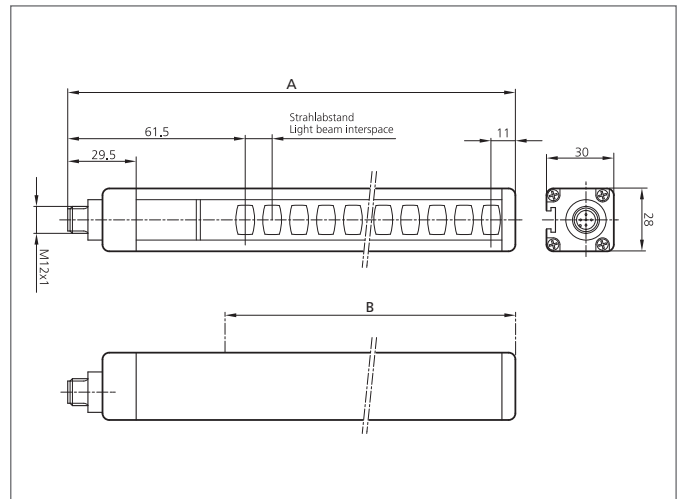

TECHNICAL INFORMATION (typ.)		+20°C, 24 V DC
Safety level		Type 4 (IEC/TS 61496-2), SIL 3 (IEC 61508), SILCL 3 (IEC 62061), PL e - Cat. 4 (EN ISO 13849-1)
Security level		Body protection
Total height (A)		1.886 mm
Protective field height (B)		1.810 mm
Model		built-in control functions (EDM), extended range
Mounting		T-shaped slot (Backside), / Holder SFB E 180 (optional)
Number of beams		24
Emitted light		Infrared, 950 nm
Safety output		PNP (2x), 400 mA / 24 V DC
Service voltage		19,2 ... 28,8 V DC
Operating distance		10 m (Low Range) / 20 m (High Range)
Resolution		90 mm
Inverse polarity protection		Yes
Display		LEDs for light curtain's status and diagnostic
Start / restart		Automatic / manual (selectable)
External Device Monitoring - EDM		Feedback input, enabling selectable
Short-circuit protection		yes
Reaction time		5 ms
Ambient temperature		-20 ... +55 °C
Protection class		IP 65, IP 67
Protection degree		III, operation on protective low voltage
Casing material		Aluminium

SLIH4-1809 Safety light curtain



TECHNICAL INFORMATION (typ.)		+20°C, 24 V DC
Material		polycarbonate (Window)
Connection		M12, 5poled for transmitter, M12, 8poled for receiver, Connector
Cable		unshielded connection cables max. 100 m
Scope of delivery		Emitter + receiver, one set of standard fixing brackets SA 6, CD-ROM containing the multi-language instruction manual, quick installation guide