

# BE-F50/50RL-G1-K-BS

## High power backlight

- High light intensity
- A minimal edge region
- Homogenous luminous field
- Very compact design
- High protection class IP 67
- Robust design

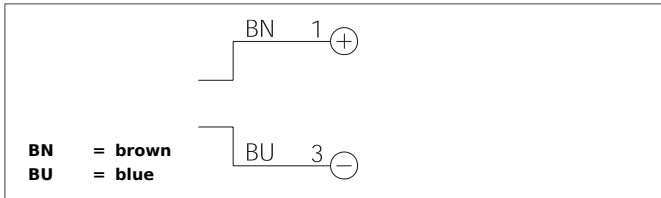

### Safety instructions

The Instruments are not to be used for safety applications, in particular applications in which safety of persons depends on proper operation of the instruments.  
These instruments shall exclusively be used by qualified personnel.

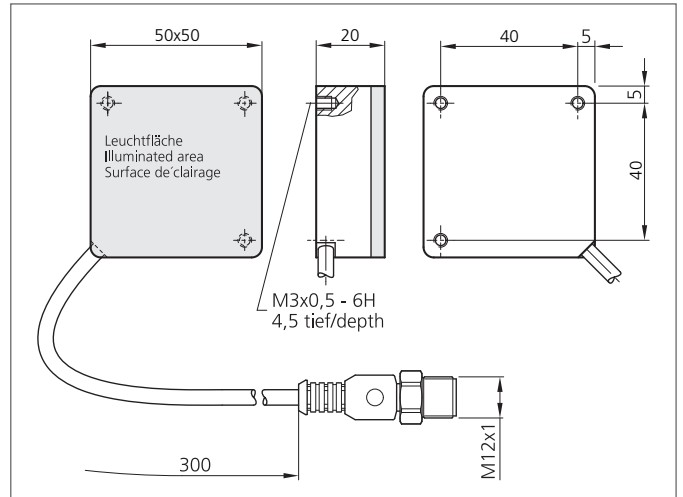

TECHNICAL INFORMATION (typ.)	+20°C, 24V DC
Design	Backlight
Illuminated area	50 x 50 mm
Light colour	Red, 625 nm
Emission angle	120°
Service voltage	24 V DC (Supply Class 2)
Internal power consumption	120 mA, (24 V DC)
Power	2,9 W (24 V DC)
Shock-/vibration load	10 ... 55 Hz / 1,0 mm / 30 g
Inverse polarity protection	No
Ambient temperature	0 ... +40 °C permanent operation
Protection class	IP 67
Protection degree	III, operation on protective low voltage
Risk group (DIN EN 62471)	Free group
Casing material	Aluminium black anodized
Material	PMMA, diffus (Protection optics)
Connection	Cable 300 mm with connector M12, 3-poled
Weight	95 g
Connecting cable	VK ...