



Level



Pressure



Flow



Temperature



Liquid
Analysis



Registration



Systems
Components



Services



Solutions

Operating Instructions

Liquicap M FMI51, FMI52 FEI50H HART

Capacitive level measurement

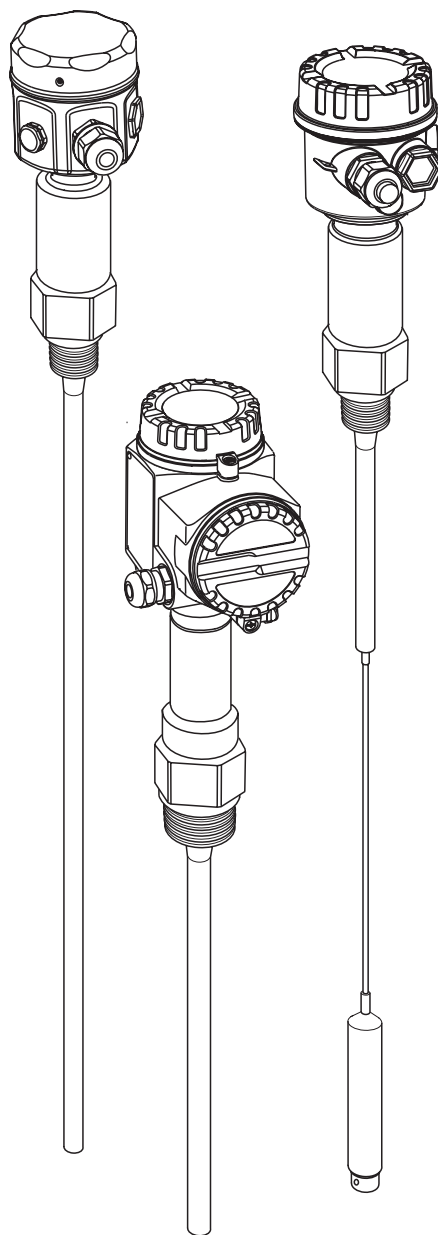

BA00298F/00/en/13.10
71123554

Valid as of software version:
FW: V 01.03.00
HW: V 02.00

Endress+Hauser

People for Process Automation

Table of contents

1	Safety instructions	3	7	Maintenance	83
1.1	Designated use	3	8	Accessories	84
1.2	Installation, commissioning and operation	3	8.1	Protective cover	84
1.3	Operational safety	3	8.2	Shortening set for FMI52	84
1.4	Notes on safety conventions and icons	4	8.3	Commubox FXA195 HART	84
2	Identification	5	8.4	HAW56x surge arrester	84
2.1	Device designation	5	8.5	Weld-in adapter	84
2.2	Scope of delivery	12	9	Troubleshooting	85
2.3	Certificates and approvals	12	9.1	Error messages at electronic insert	85
2.4	Trademarks	12	9.2	System error messages	85
3	Installation	13	9.3	Possible measuring errors	88
3.1	Quick installation guide	13	9.4	Spare Parts	88
3.2	Incoming acceptance, transport, storage	13	9.5	Return	89
3.3	Planning instructions	14	9.6	Disposal	89
3.4	Measuring condition	15	9.7	Software history	89
3.5	Minimum probe length for nonconductive media ($<1\mu\text{s}/\text{cm}$)	16	10	Technical data	90
3.6	Installation examples	16	10.1	Technical data: probe	90
3.7	With separate housing	21	10.2	Input	90
3.8	Installation instructions	24	10.3	Output	91
3.9	Post-installation check	26	10.4	Performance characteristics	91
4	Wiring	27	10.5	Operating conditions: Environment	93
4.1	Recommendations for connection	27	10.6	Operating conditions: Process	94
4.2	Wiring and connecting	28	10.7	Certificates and approvals	97
4.3	Post-connection check	31	10.8	Documentation	97
5	Operation	32	11	Operating menu	99
5.1	Operating options	32	11.1	"Basic setup" menu Commissioning with display and operating module	99
5.2	Error messages	44	11.2	"Safety setting" menu	100
5.3	Locking/unlocking configuration	45	11.3	"Linearization" menu	101
5.4	Resetting to factory setting (reset)	45	11.4	"Output" menu	102
5.5	Operation via FieldCare Device Setup	46	11.5	"Device properties" menu	103
5.6	Operation via HART handheld terminal DXR375 ..	47	Index	104	
6	Commissioning	48			
6.1	Installation and function check	48			
6.2	Basic setup without the display/operating module ..	48			
6.3	"Basic setup" menu Commissioning with display and operating module	53			
6.4	"Safety setting" menu	59			
6.5	"Linearization" menu	63			
6.6	"Output" menu	69			
6.7	"Device properties" menu	73			
6.8	Operation	77			
6.9	FieldCare: operating program from Endress+Hauser	77			

1 Safety instructions

1.1 Designated use

Liquicap M FMI51, FMI52 are compact, capacitance level transmitters for the continuous measurement of liquids.

1.2 Installation, commissioning and operation

Liquicap M is designed to meet state-of-the-art safety regulations and complies with the applicable requirements and EC Directives. If used improperly or other than intended, the device can, however, be a source of application-related danger, e.g. product overflow as a result of incorrect installation or configuration. For this reason, installation, electrical connection, commissioning, operation and maintenance of the measuring system must only be carried out by trained technical personnel authorized to perform such work by the owner-operator. The technical personnel must have read and understood these Operating Instructions and must follow the instructions they contain. The device may only be repaired or modified if expressly permitted in the Operating Instructions.

1.3 Operational safety

When performing configuration, testing and maintenance work on the device, alternative supervisory measures must be taken to guarantee the operational safety and process safety.













1.3.1 Ex area

When using the measuring system in Ex-areas, the appropriate national standards and regulations have to be observed. Separate Ex documentation, which constitutes an integral part of this documentation, is supplied with the device. The installation procedures, connection data and safety instructions it contains must be observed.

- Make sure that the technical staff has adequate training.
- The special measuring and safety-related requirements for the measuring points must be observed.

1.4 Notes on safety conventions and icons

To highlight safety-related or alternative processes, we have designed the following safety instructions where every instruction is indicated by a corresponding pictogram.

Safety instructions	
	<p>Warning! Draws attention to activities or procedures that can result in serious injuries to persons, a safety risk or the destruction of the device if not carried out properly.</p>
	<p>Caution! Draws attention to activities or procedures that can result in injuries to persons or the defective operation of the device if not carried out properly.</p>
	<p>Note! Draws attention to activities or procedures that have an indirect effect on operation, or can trigger an unforeseen device reaction if not carried out properly.</p>
Type of protection	
	<p>Explosion-protected equipment tested for type examination If this sign can be found on the nameplate of the device, the device can be operated in hazardous areas or non-hazardous areas in accordance with the approval</p>
	<p>Ex area This symbol in the drawings in these Operating Instructions indicates Ex-areas. Devices located in Ex-areas, or cables for such devices, must have appropriate explosion protection.</p>
	<p>Safe area (non-hazardous area) This symbol in the drawings in these Operating Instructions indicates non-Ex areas. Devices in non-hazardous areas must also be certified if connecting cables lead into hazardous areas.</p>
Electrical symbols	
	<p>Direct current A terminal to which direct voltage is applied or through which the direct current flows.</p>
	<p>Alternating current A terminal to which alternating voltage (sine wave) is applied or through which the alternating current flows.</p>
	<p>Ground connection A grounded terminal which, from a user's point of view, is grounded via a grounding system.</p>
	<p>Protective earth connection A terminal that has to be grounded before any other connections may be established.</p>
	<p>Equipotential connection A connection that has to be connected to the grounding system of the plant. This can be a potential matching line or a star grounding system, depending on national or company codes of practice.</p>
	<p>Immunity to temperature change of the connecting cables Means that the connecting cables have to withstand a temperature of 85 °C at least.</p>

2 Identification

2.1 Device designation

2.1.1 Nameplate

You can take the following technical data from the nameplate of the device:

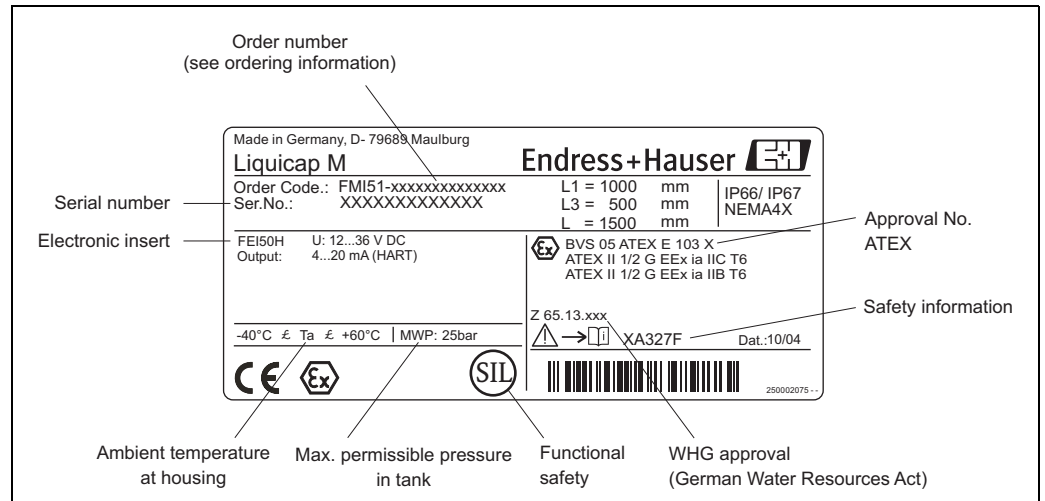

Information on the Liquicap M nameplate (example)

2.1.2 Product structure



Note!

The product structure is used to identify the alphanumeric order number (see nameplate: Order Code).

Liquicap M FMI51 (device identification)

10	Approval:
A	Non-hazardous area
B	Non-hazardous area, WHG
C	ATEX II 1/2 GD EEx ia IIC T6
D	ATEX II 1/2 GD EEx ia IIC T6, WHG
E	ATEX II 1/2 GD EEx ia IIB T6
F	ATEX II 1/2 GD EEx ia IIB T6, WHG
G	ATEX II 1/2 G EEx d (ia) IIB T6, WHG
H	ATEX II 1/2 GD EEx ia IIC T6, XA, note safety instruction (XA) (electrostatic charging)!
J	ATEX II 1/2 GD EEx ia IIC T6, WHG XA, note safety instruction (XA) (electrostatic charging)!
K	ATEX II 1/2 G EEx ia IIC T6, WHG XA, note safety instruction (XA) (electrostatic charging)!
L	ATEX II 1/2 G EEx de (ia) IIC T6, WHG XA, note safety instruction (XA) (electrostatic charging)!
M	ATEX II 3 GD EEx nA II T6, WHG XA, note safety instruction (XA) (electrostatic charging)!
N	CSA General Purpose, CSA C US
P	CSA/FM IS Cl. I, II, III Div. 1+2 Gr. A-G
R	CSA/FM XP Cl. I, II, III Div. 1+2 Gr. A-G
S	TIIS Ex ia IIC T3
T	TIIS Ex d IIC T3
1	NEPSI Ex ia IIC T6
2	NEPSI Ex d(ia) IIC T6
4	NEPSI Ex nA IIC T6
5	IECEx Ga/Gb Ex ia IIC T6; Ex iaD 20/ Ex tD A21

10	Approval:			
	6	IECEX Ga/Gb Ex ia IIC T6		
	Y	Special version, to be specified		
20	Inactive Length L3:			
	Price per 100 mm/1 inch			
	L3: 100 to 2000 mm/4 to 80 inch for 316L			
	L3: 150 to 1000 mm/6 to 40 inch for PTFE fully insulated			
	Protection against condensate + bypassing container nozzles			
	1	Not selected		
	2 mm,	316L	
	3 mm,	316L + fully insulated PTFE	
	5 inch,	316L	
	6 inch,	316L + fully insulated PTFE	
	9	Special version, to be specified		
30	Active Probe Length L1; Insulation:			
	Price per 100 mm/1 inch			
	L1: 100 to 4000 mm/4 to 160 inch for Ø10 mm, Ø16 mm			
	L1: 150 to 3000 mm/6 to 120 inch for Ø22 mm (fully insulated)			
	A mm L1, 10 mm rod,	316L; PTFE	
	B mm L1, 16 mm rod,	316L; PTFE	
	C mm L1, 22 mm rod,	316L; PTFE	
	D mm L1, 16 mm rod,	316L; PFA	
	E mm L1, 10 mm rod,	316L; PTFE + ground tube	
	F mm L1, 16 mm rod,	316L; PTFE + ground tube	
	G mm L1, 16 mm rod,	316L; PFA + ground tube	
	H inch L1, 0.4 inch rod,	316L; PTFE	
	K inch L1, 0.6 inch rod,	316L; PTFE	
	M inch L1, 0.9 inch rod,	316L; PTFE	
	N inch L1, 0.6 inch rod,	316L; PFA	
	P inch L1, 0.4 inch rod,	316L; PTFE + ground tube	
	R inch L1, 0.6 inch rod,	316L; PTFE + ground tube	
	S inch L1, 0.6 inch rod,	316L; PFA + ground tube	
	Y	Special version, to be specified		
50	Process Connection:			Ø inactive length (mm)
	Threaded connection			
	GCJ	G ½,	316L, 25 bar	Thread ISO228 22
	GDJ	G ¾,	316L, 25 bar	Thread ISO228 22
	GEJ	G 1,	316L, 25 bar	Thread ISO228 22
	GGJ	G 1½,	316L, 100 bar	Thread ISO228 43
	RCJ	NPT ½,	316L, 25 bar	Thread ANSI 22
	RDJ	NPT ¾,	316L, 25 bar	Thread ANSI 22
	REJ	NPT 1,	316L, 25 bar	Thread ANSI 22
	RGJ	NPT 1½,	316L, 100 bar	Thread ANSI 43
	Hygiene connection			
	GOJ	G ¾	316L, 25 bar, EHEDG	Thread ISO228 -
	Accessories installation, weld-in adapter			
	GWJ	G 1	316L, 25 bar, EHEDG	Thread ISO228 -
	Accessories installation, weld-in adapter			
	MRJ	DN50 PN40,	316L	DIN11851 22/43***
	UPJ	Universal adapter 44 mm	316L, 16 bar	-
	Tri-Clamp connection			
	TCJ	DN25 (1"), EHEDG	316L,	Tri-Clamp ISO2852 22
	TJJ	DN38 (1½"), EHEDG	316L,	Tri-Clamp ISO2852 22
	TJK	DN38 (1½"), EHEDG	PTFE >316L, 3A	Tri-Clamp ISO2852 22
	TDJ	DN40-51 (2"),	316L,	Tri-Clamp ISO2852 43
	TDK	DN40-51 (2"), EHEDG	PTFE >316L, 3A,	Tri-Clamp ISO2852 -
	TNJ	DN38 (1½"),	316L, 3A, EHEDG	Tri-Clamp ISO2852 -
	clamp detachable			
	EN flanges			
	B0J	DN25 PN25/40 A,	316L	Flange EN1092-1 (DIN2527 B) 22
	B1J	DN32 PN25/40 A,	316L	Flange EN1092-1 (DIN2527 B) 22
	B2J	DN40 PN25/40 A,	316L	Flange EN1092-1 (DIN2527 B) 22

50	Process Connection:					∅ inactive length (mm)
B3J	DN50 PN25/40 A,	316L	Flange EN1092-1 (DIN2527 B)	22/43***		
CRJ	DN50 PN25/40 B1,	316L	Flange EN1092-1 (DIN2527 C)	43		
DRJ	DN50 PN40 C,	316L	Flange EN1092-1 (DIN2512 F)	43		
ERJ	DN50 PN40 D,	316L	Flange EN1092-1 (DIN2512 N)	43		
BSJ	DN80 PN10/16 A,	316L	Flange EN1092-1 (DIN2527 B)	43		
CGJ	DN80 PN10/16 B1,	316L	Flange EN1092-1 (DIN2527 C)	43		
DGJ	DN80 PN16 C,	316L	Flange EN1092-1 (DIN2512 F)	43		
EGJ	DN80 PN16 D,	316L	Flange EN1092-1 (DIN2512 N)	43		
BTJ	DN100 PN10/16 A,	316L	Flange EN1092-1 (DIN2527 B)	43		
CHJ	DN100 PN10/16 B1,	316L	Flange EN1092-1 (DIN2527 C)	43		
B0K	PTFE clad DN25 PN25/40,	PTFE >316L	Flange EN1092-1 (DIN2527)	-		
B1K	DN32 PN25/40,	PTFE >316L	Flange EN1092-1 (DIN2527)	-		
B2K	DN40 PN25/40,	PTFE >316L	Flange EN1092-1 (DIN2527)	-		
B3K	DN50 PN25/40,	PTFE >316L	Flange EN1092-1 (DIN2527)	-		
BSK	DN80 PN10/16,	PTFE >316L	Flange EN1092-1 (DIN2527)	-		
BTK	DN100 PN10/16,	PTFE >316L	Flange EN1092-1 (DIN2527)	-		
ANSI flanges						
ACJ	1" 150 lbs RF,	316/316L	Flange ANSI B16.5	22		
ANJ	1" 300 lbs RF,	316/316L	Flange ANSI B16.5	22		
AEJ	1½" 150 lbs RF,	316/316L	Flange ANSI B16.5	22		
AQJ	1½" 300 lbs RF,	316/316L	Flange ANSI B16.5	22		
AFJ	2" 150 lbs RF,	316/316L	Flange ANSI B16.5	22/43***		
ARJ	2" 300 lbs RF,	316/316L	Flange ANSI B16.5	22/43***		
AGJ	3" 150 lbs RF,	316/316L	Flange ANSI B16.5	43		
ASJ	3" 300 lbs RF,	316/316L	Flange ANSI B16.5	43		
AHJ	4" 150 lbs RF,	316/316L	Flange ANSI B16.5	43		
ATJ	4" 300 lbs RF,	316/316L	Flange ANSI B16.5	43		
AJJ	6" 150 lbs RF,	316/316L	Flange ANSI B16.5	43		
AUJ	6" 300 lbs RF,	316/316L	Flange ANSI B16.5	43		
PTFE clad						
ACK	1" 150 lbs,	PTFE >316/316L	Flange ANSI B16.5	-		
ANK	1" 300 lbs,	PTFE >316/316L	Flange ANSI B16.5	-		
AEK	1½" 150 lbs,	PTFE >316/316L	Flange ANSI B16.5	-		
AQK	1½" 300 lbs,	PTFE >316/316L	Flange ANSI B16.5	-		
AFK	2" 150 lbs,	PTFE >316/316L	Flange ANSI B16.5	-		
ARK	2" 300 lbs,	PTFE >316/316L	Flange ANSI B16.5	-		
AGK	3" 150 lbs,	PTFE >316/316L	Flange ANSI B16.5	-		
AHK	4" 150 lbs,	PTFE >316/316L	Flange ANSI B16.5	-		
JIS flanges						
KCJ	10K 25 RF,	316L	Flange JIS B2220	22		
KEJ	10K 40 RF,	316L	Flange JIS B2220	22		
KFJ	10K 50 RF,	316L	Flange JIS B2220	22/43***		
KGJ	10K 80 RF,	316L	Flange JIS B2220	22/43***		
KHJ	10K 100 RF,	316L	Flange JIS B2220	22/43***		
KRJ	20K 50 RF,	316L	Flange JIS B2220	43		
PTFE clad						
KCK	10K 25 RF,	PTFE >316L	Flange JIS B2220	-		
KEK	10K 40 RF,	PTFE >316L	Flange JIS B2220	-		
KFK	10K 50 RF,	PTFE >316L	Flange JIS B2220	-		
KGK	10K 80 RF,	PTFE >316L	Flange JIS B2220	-		
KHK	10K 100 RF,	PTFE >316L	Flange JIS B2220	-		
YY9	Special version, to be specified					

Liquicap M FMI51 (device identification)

10	Approval:			
	A	Non-hazardous area		
	B	Non-hazardous area,	WHG	
	E	ATEX II 1/2 GD	EEx ia IIB T6	
	F	ATEX II 1/2 GD	EEx ia IIB T6,	WHG
	G	ATEX II 1/2 G	EEx d (ia) IIB T6,	WHG
	H	ATEX II 1/2 GD	EEx ia IIC T6,	
		XA, note safety instruction (XA) (electrostatic charging)!		
	J	ATEX II 1/2 GD	EEx ia IIC T6,	
		XA, note safety instruction (XA) (electrostatic charging)!		
	K	ATEX II 1/2 G	EEx ia IIC T6,	WHG
		XA, note safety instruction (XA) (electrostatic charging)!		
	L	ATEX II 1/2 G	EEx de (ia) IIC T6,	WHG
		XA, note safety instruction (XA) (electrostatic charging)!		
	M	ATEX II 3 GD	EEx nA II T6,	WHG
		XA, note safety instruction (XA) (electrostatic charging)!		
	N	CSA General Purpose, CSA C US		
	P	CSA/FM IS Cl. I, II, III	Div. 1+2 Gr. A-G	
	R	CSA/FM XP Cl. I, II, III	Div. 1+2 Gr. A-G	
	S	TIIS Ex ia IIC T3		
	T	TIIS Ex d IIC T3		
	1	NEPSI Ex ia IIC T6		
	2	NEPSI Ex d(ia) IIC T6		
	4	NEPSI Ex nA IIC T6		
	5	IECEX Ga/Gb Ex ia IIC T6; Ex iaD 20/ Ex tD A21		
	6	IECEX Ga/Gb Ex ia IIC T6		
	Y	Special version, to be specified		
20	Inactive Length L3:			
		Price per 100 mm/1 inch		
		L3: 100 to 2000 mm/4 to 80 inch for 316L		
		L3: 150 to 1000 mm/6 to 40 inch for PFA fully insulated		
		Protection against condensate + bypassing container nozzles		
	1	Not selected		
	2	... mm L3,	316L	
	3	... mm L3,	316L + fully insulated PFA	
	5	... inch L3,	316L	
	6	... inch L3,	316L + fully insulated PFA	
	9	Special version, to be specified		
30	Active Probe Length L1; Insulation:			
		Price per 1000 mm/10 inch		
		L1: 420 to 10000 mm/17 to 400 inch; fully insulated		
	A	... mm L1,	316; FEP	
	B	... mm L1,	316; PFA	
	C	... inch L1,	316; FEP	
	D	... inch L1,	316; PFA	
	Y	Special version, to be specified		
50	Process Connection: ∅ inactive length (mm)			
		Threaded connection		
	GDJ	G ¾,	316L, 25 bar	Thread ISO228 22
	GEJ	G 1,	316L, 25 bar	Thread ISO228 22
	GGJ	G 1½,	316L, 100 bar	Thread ISO228 43
	RDJ	NPT ¾,	316L, 25 bar	Thread ANSI 22
	REJ	NPT 1,	316L, 25 bar	Thread ANSI 22
	RGJ	NPT 1½,	316L, 100 bar	Thread ANSI 43
		Hygiene connection		
	GWJ	G 1	316L, 25 bar, EHEDG	Thread ISO228 –
		Accessories installation, weld-in adapter		
	MRJ	DN50 PN40,	316L	DIN11851 43
	UPJ	Universal adapter 44 mm	316L, 16 bar, EHEDG	–
		Tri-Clamp connection		
	TCJ	DN25 (1"), EHEDG	316L,	Tri-Clamp ISO2852 22
	TJJ	DN38 (1½"), EHEDG	316L,	Tri-Clamp ISO2852 22
	TJK	DN38 (1½"), EHEDG	PTFE >316L, 3A	Tri-Clamp ISO2852 22
	TDJ	DN40-51 (2"),	316L,	Tri-Clamp ISO2852 43
	TDK	DN40-51 (2"), EHEDG	PTFE >316L, 3A,	Tri-Clamp ISO2852 –

50		Process Connection:			∅ inactive length (mm)
EN flanges					
B0J	DN25 PN25/40 A,	316L	Flange EN1092-1 (DIN2527 B)	22	
B1J	DN32 PN25/40 A,	316L	Flange EN1092-1 (DIN2527 B)	22	
B2J	DN40 PN25/40 A,	316L	Flange EN1092-1 (DIN2527 B)	22	
B3J	DN50 PN25/40 A,	316L	Flange EN1092-1 (DIN2527 B)	43	
CRJ	DN50 PN25/40 B1,	316L	Flange EN1092-1 (DIN2527 C)	43	
DRJ	DN50 PN40 C,	316L	Flange EN1092-1 (DIN2512 F)	43	
ERJ	DN50 PN40 D,	316L	Flange EN1092-1 (DIN2512 N)	43	
BSJ	DN80 PN10/16 A,	316L	Flange EN1092-1 (DIN2527 B)	43	
CGJ	DN80 PN10/16 B1,	316L	Flange EN1092-1 (DIN2527 C)	43	
DGJ	DN80 PN16 C,	316L	Flange EN1092-1 (DIN2512 F)	43	
EGJ	DN80 PN16 D,	316L	Flange EN1092-1 (DIN2512 N)	43	
BTJ	DN100 PN10/16 A,	316L	Flange EN1092-1 (DIN2527 B)	43	
CHJ	DN100 PN10/16 B1,	316L	Flange EN1092-1 (DIN2527 C)	43	
PTFE clad					
B0K	DN25 PN25/40,	PTFE >316L	Flange EN1092-1 (DIN2527)	-	
B1K	DN32 PN25/40,	PTFE >316L	Flange EN1092-1 (DIN2527)	-	
B2K	DN40 PN25/40,	PTFE >316L	Flange EN1092-1 (DIN2527)	-	
B3K	DN50 PN25/40,	PTFE >316L	Flange EN1092-1 (DIN2527)	-	
BSK	DN80 PN10/16,	PTFE >316L	Flange EN1092-1 (DIN2527)	-	
BTK	DN100 PN10/16,	PTFE >316L	Flange EN1092-1 (DIN2527)	-	
ANSI flanges					
ACJ	1" 150 lbs RF,	316/316L	Flange ANSI B16.5	22	
ANJ	1" 300 lbs RF,	316/316L	Flange ANSI B16.5	22	
AEJ	1½" 150 lbs RF,	316/316L	Flange ANSI B16.5	22	
AQJ	1½" 300 lbs RF,	316/316L	Flange ANSI B16.5	43	
AFJ	2" 150 lbs RF,	316/316L	Flange ANSI B16.5	43	
ARJ	2" 300 lbs RF,	316/316L	Flange ANSI B16.5	43	
AGJ	3" 150 lbs RF,	316/316L	Flange ANSI B16.5	43	
ASJ	3" 300 lbs RF,	316/316L	Flange ANSI B16.5	43	
AHJ	4" 150 lbs RF,	316/316L	Flange ANSI B16.5	43	
ATJ	4" 300 lbs RF,	316/316L	Flange ANSI B16.5	43	
AJJ	6" 150 lbs RF,	316/316L	Flange ANSI B16.5	43	
AUJ	6" 300 lbs RF,	316/316L	Flange ANSI B16.5	43	
PTFE clad					
ACK	1" 150 lbs,	PTFE >316/316L	Flange ANSI B16.5	-	
ANK	1" 300 lbs,	PTFE >316/316L	Flange ANSI B16.5	-	
AEK	1½" 150 lbs,	PTFE >316/316L	Flange ANSI B16.5	-	
AQK	1½" 300 lbs,	PTFE >316/316L	Flange ANSI B16.5	-	
AFK	2" 150 lbs,	PTFE >316/316L	Flange ANSI B16.5	-	
ARK	2" 300 lbs,	PTFE >316/316L	Flange ANSI B16.5	-	
AGK	3" 150 lbs,	PTFE >316/316L	Flange ANSI B16.5	-	
AHK	4" 150 lbs,	PTFE >316/316L	Flange ANSI B16.5	-	
JIS flanges					
KCJ	10K 25 RF,	316L	Flange JIS B2220	22	
KEJ	10K 40 RF,	316L	Flange JIS B2220	22	
KFJ	10K 50 RF,	316L	Flange JIS B2220	43	
KGJ	10K 80 RF,	316L	Flange JIS B2220	43	
KHJ	10K 100 RF,	316L	Flange JIS B2220	43	
KRJ	20K 50 RF,	316L	Flange JIS B2220	43	
PTFE clad					
KCK	10K 25 RF,	PTFE >316L	Flange JIS B2220	-	
KEK	10K 40 RF,	PTFE >316L	Flange JIS B2220	-	

50										Process Connection:	∅ inactive length (mm)		
										KFK	10K 50 RF, PTFE >316L	Flange JIS B2220	–
										KGK	10K 80 RF, PTFE >316L	Flange JIS B2220	–
										KHK	10K 100 RF, PTFE >316L	Flange JIS B2220	–
										YY9	Special version, to be specified		
60										Electronics; Output:			
										A	FEI50H; 4 to 20 mA HART + display		
										B	FEI50H; 4 to 20 mA HART		
										C	FEI57C; PFM		
										V	None; Prepared for FEI5x + display,	cover high, transparent	
										W	None; Prepared for FEI5x,	cover flat	
										Y	Special version, to be specified		
70										Housing:			
										1	F15 316L	IP66, NEMA4X	
										2	F16 polyester	IP66, NEMA4X	
										3	F17 aluminum	IP66, NEMA4X	
										4	F13 aluminum + gas-tight probe seal	IP66, NEMA4X	
										5	T13 Alu + gas-tight probe seal + separate connection compartment	IP66, NEMA4X	
										6	F27 316L + gas-tight probe seal	IP68, NEMA6P	
										9	Special version, to be specified		
80										Cable Entry:			
										A	Gland M20 (EEx d > thread M20)		
										B	Thread G ½		
										C	Thread NPT ½		
										D	Thread NPT ¾		
										E	Plug M12		
										Y	Special version, to be specified		
90										Type of Probe:			
										L4:	100 to 6000 mm/12 to 240 inch		
										1	Compact		
										2	2000 mm L4 cable > separate housing		
										3mm L4 cable > separate housing		
										4	80 inch L4 cable > separate housing		
										5inch L4 cable > separate housing		
										9	Special version, to be specified		
100										Additional Option:			
										A	Basic version		
										D	EN10204-3.1 (316L wetted parts/pressurized), inspection certificate		
										E	EN10204-3.1, NACE MR0175 (316L wetted parts/pressurized), inspection certificate		
										F	SIL Declaration of Conformity		
										S	GL marine certificate		
										Y	Special version, to be specified		
FMI52											Product designation		

2.2 Scope of delivery



Caution!

Please pay attention to the instructions on unpacking, transporting and storing the measuring devices outlined in the "Incoming acceptance, transport, storage" section on → 13.

The scope of delivery comprises:

- The installed device
- FieldCare Device Setup (operating program)
- Optional accessories (→ 83)

Documentation supplied:

- Operating Instructions
- Approval documentation; if not listed in the Operating Instructions.

2.3 Certificates and approvals

CE mark, Declaration of Conformity

The device has been constructed and tested to state-of-the-art operational safety standards and left the factory in perfect condition as regards technical safety. The device complies with the applicable standards and regulations that are listed in the EC Declaration of Conformity and thus meets the legal requirements of the EC Directives. Endress+Hauser confirms that the device has been tested successfully by affixing the CE mark.

2.4 Trademarks

Tri-Clamp®

Registered trademark of Ladish & Co., Inc., Kenosha, USA

3.3 Planning instructions

3.3.1 Installation

The Liquicap M FMI51 (rod probe) can be installed from above and from below.
The Liquicap M FMI52 (rope probe) can be installed vertically from above.



Note!

- The probe may not come into contact with the container wall!
- Recommended distance from the container floor: ≥ 10 mm.
- Do not install probes in the area of the filling curtain!
- If using the probe in agitator tanks, make sure the probe is at a sufficient distance from the agitator.
- Rod probes with a ground tube must be used in the event of severe lateral load.

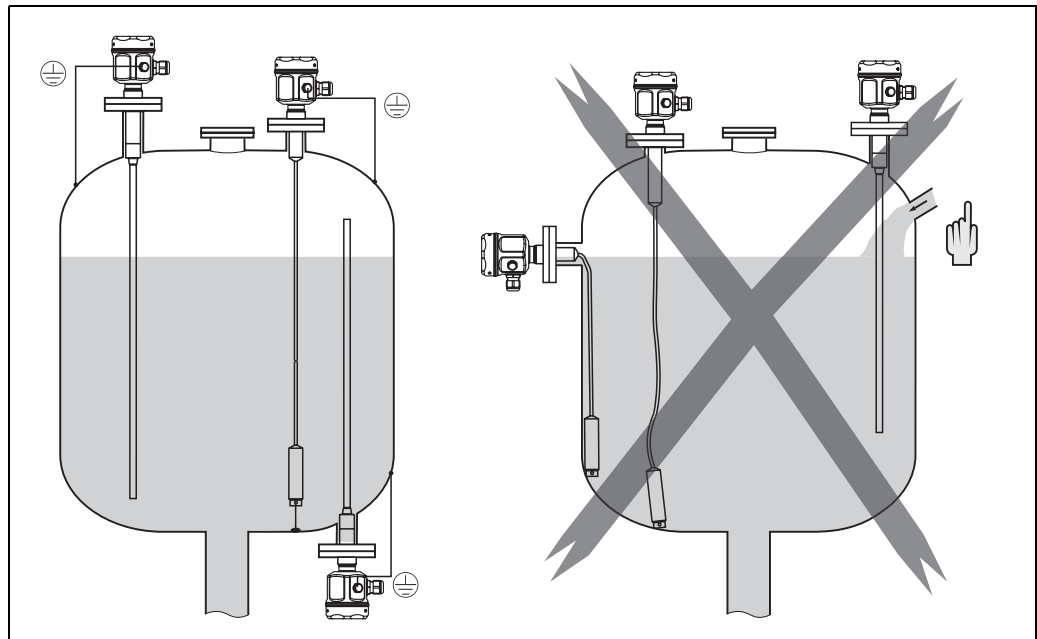

L00-FMI5xxxx-11-06-xx-xx-003

3.3.2 Support with marine approval (GL)

Conductive or nonconductive support can be provided for fully insulated rod probes. Partially insulated rod probes may only be supported with insulation at the uninsulated end of the probe.



Note!

- Rod probes with a diameter of 10 mm and 16 mm have to be supported with a length ≥ 1 m (see drawing).

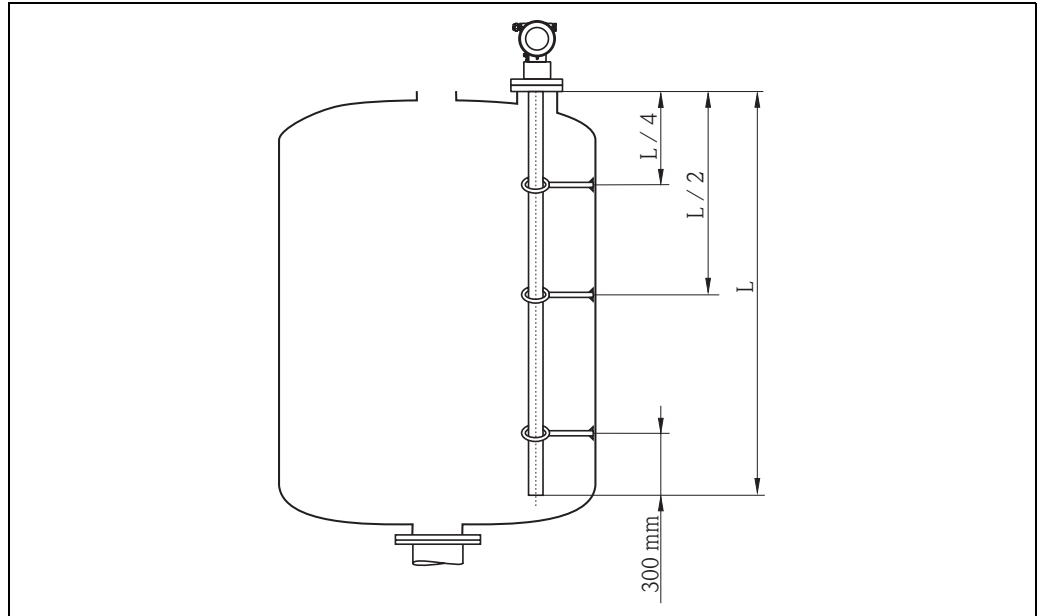

Example for calculating distances:

Probe length $L = 2000$ mm.

$L/4 = 500$ mm

$L/2 = 1000$ mm

Measured from the end of the probe rod = 300 mm.

3.4 Measuring condition

- Measuring range $L1$ possible from the tip of the probe to the process connection.
- Particularly suited for small containers.
- Use a ground tube for nonconductive media.

Note!

When installing in a nozzle, use inactive length ($L3$).

The 0 %, 100 % calibration can be inverted.

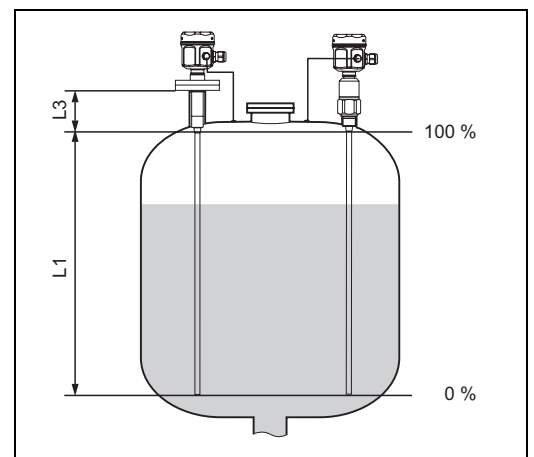

3.5 Minimum probe length for nonconductive media (<math><1\mu\text{s}/\text{cm}</math>)

$$l_{\min} = \Delta C_{\min} / (C_s * [\epsilon_r - 1])$$

l_{\min} = Minimum probe length

ΔC_{\min} = 5 pF

C_s = Probe capacitance in air (see also → 89, "Additional capacitance")

ϵ_r = Dielectric constant e.g. oil = 2.0

3.6 Installation examples

3.6.1 Rod probes

Conductive tanks (metal tanks)

If the process connection of the probe is insulated from the metal tank (e.g. using seal material), the ground connection on the probe housing must be connected to the tank using a short line.



Note!

- A fully insulated rod probe may be neither shortened nor extended.
- If the insulation of the probe rod is damaged, this results in an incorrect measurement result.
- These application examples show vertical installation for continuous level measurement.

FMI51: rod probe

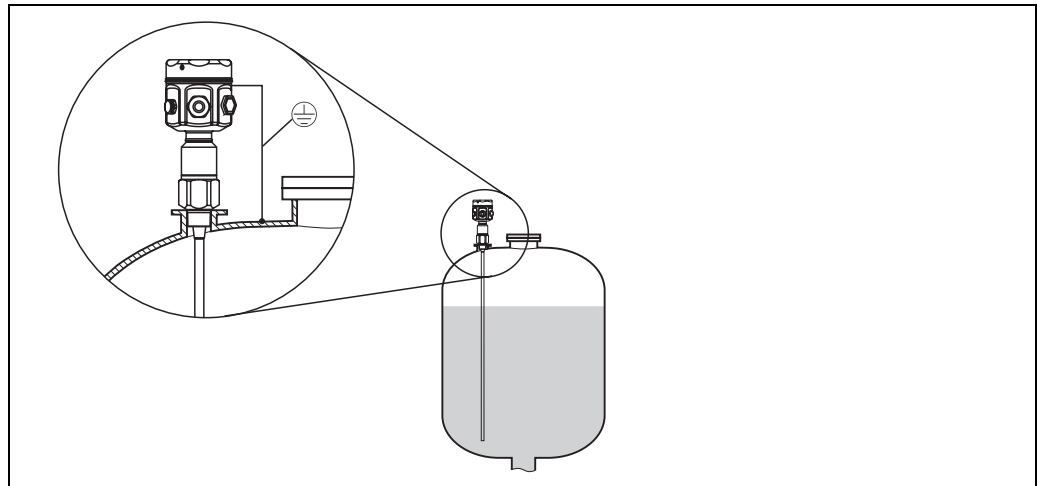

L00-FMI5xxxx-11-06-xx-xx-004

FMI51: rod probe with ground tube

Nonconductive tanks (plastic tanks)

When installing in a plastic tank, a probe with a ground tube must be used.

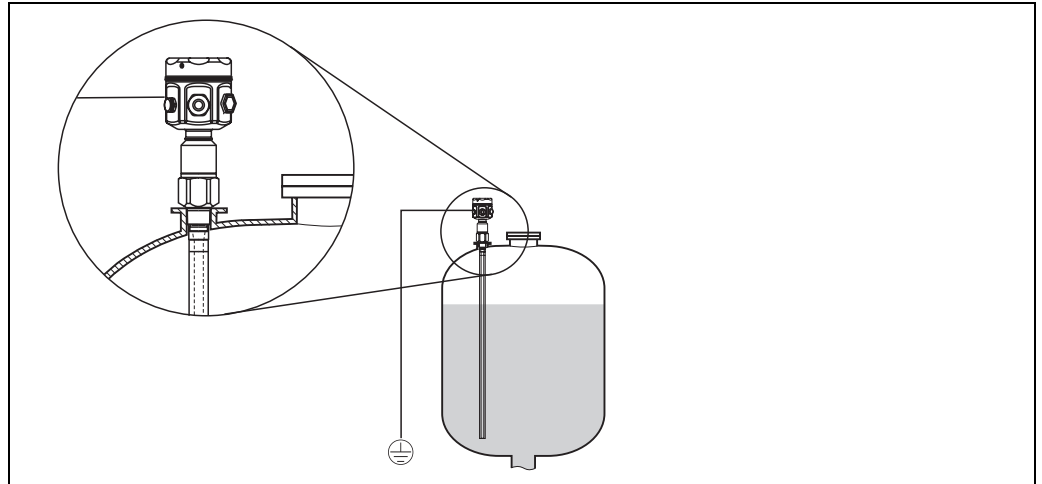

L00-FMI5xxxx-11-00-xx-xx-005

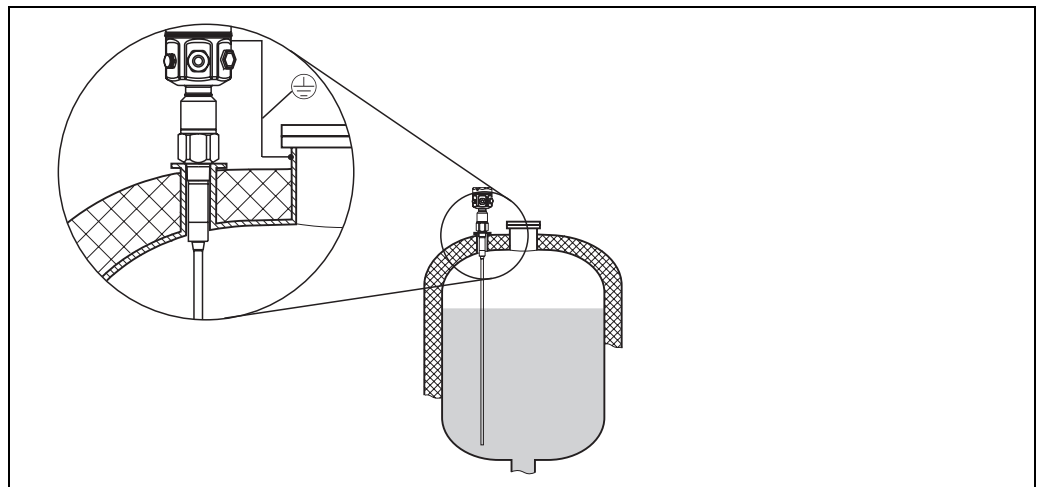
FMI51: rod probe with inactive length (e.g. for insulated tanks)

L00-FMI5xxxx-11-00-xx-xx-006

FMI51: rod probe with ground tube and inactive length (for mounting nozzles)

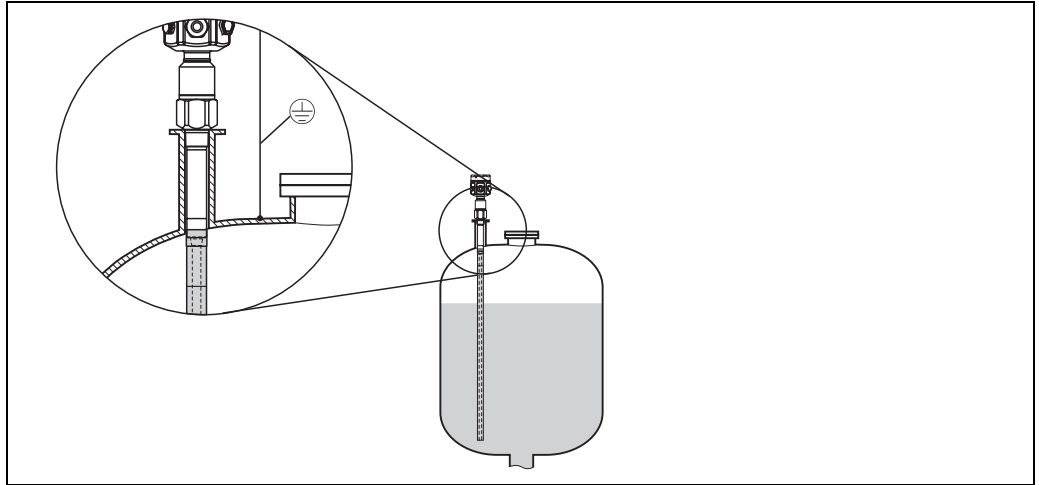

L00-FMI5xxxx-11-06-xx-xx-007

FMI51: fully insulated probe with clad flange for aggressive media

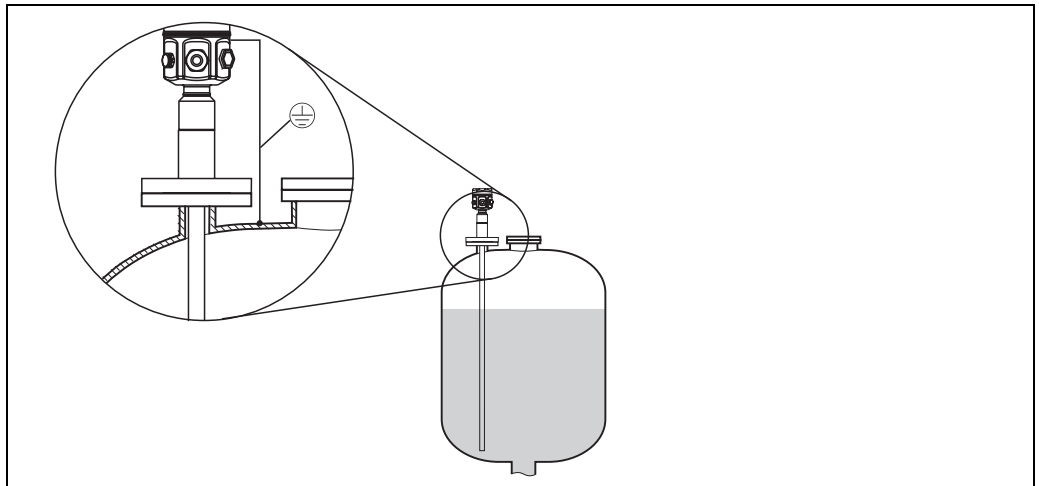

L00-FMI5xxxx-11-06-xx-xx-011

3.6.2 Rope probes



Note!

These application examples show the installation of rope probes for continuous level measurement.

FMI52: rope probe

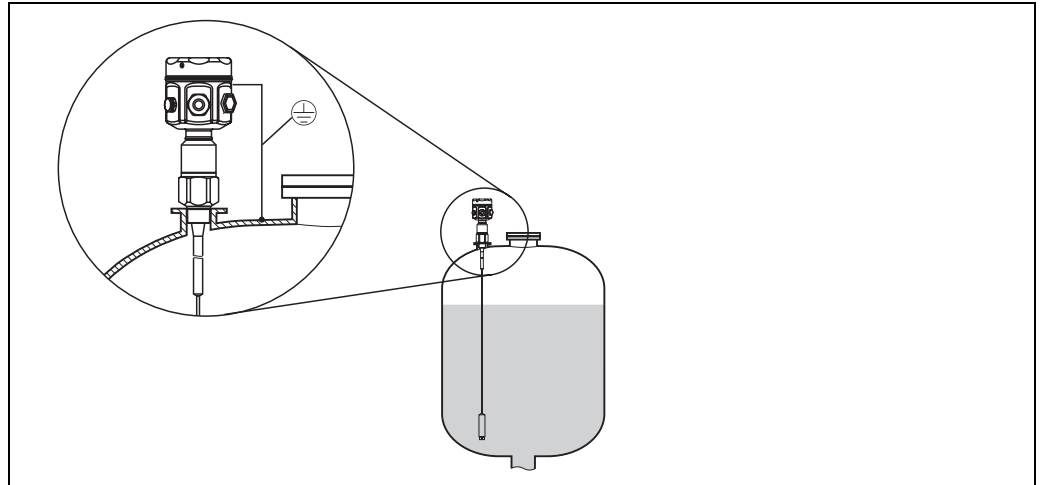

L00-FMI5xxxx-11-06-xx-xx-008

FMI52: rope probe with inactive length (e.g. for insulated tanks)

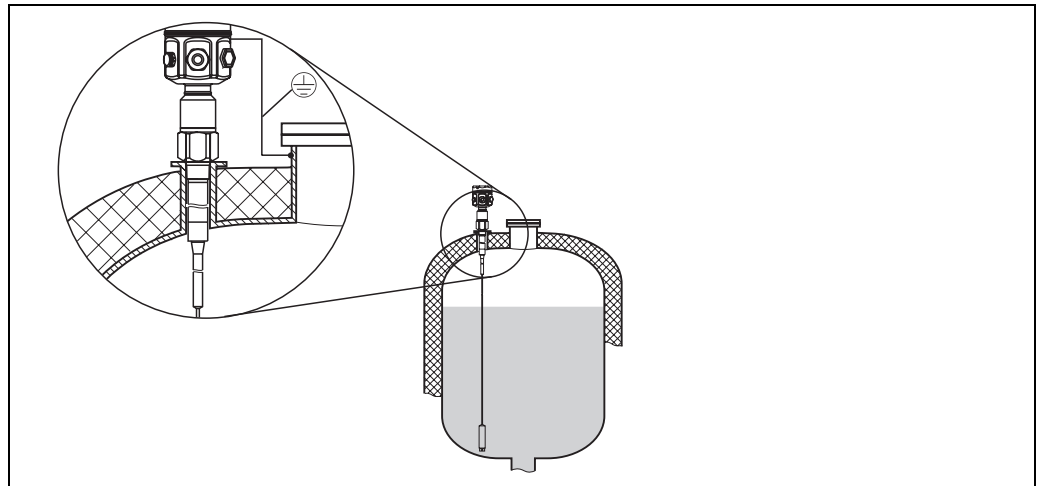

L00-FMI5xxxx-11-06-xx-xx-009

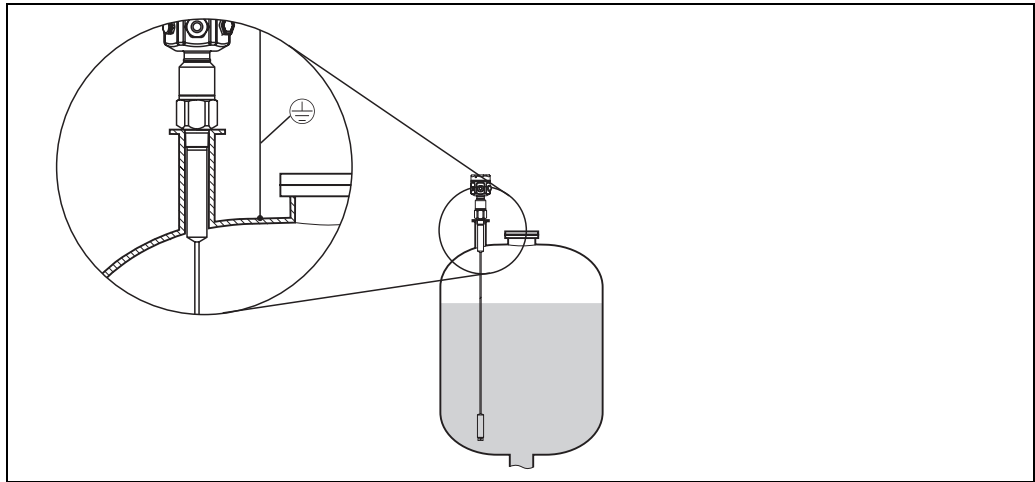
FMI52: rope probe with fully insulated inactive length (for mounting nozzles)

L00-FMI5xxxx-11-06-xx-xx-010

3.6.3 Shortening the rope

Note!

See Operating Instructions, rope shortening kit KA061F/00.

3.6.4 Tensioning weight with tension

The end of the probe needs to be secured if the probe would otherwise touch the silo wall or another part in the tank. This is what the internal thread in the probe weight is intended for.

The bracing can be conductive or insulating to the tank wall.

To avoid too high a tensile load the rope should be loose or guyed with a spring. The maximum tensile load may not exceed 200 Nm.

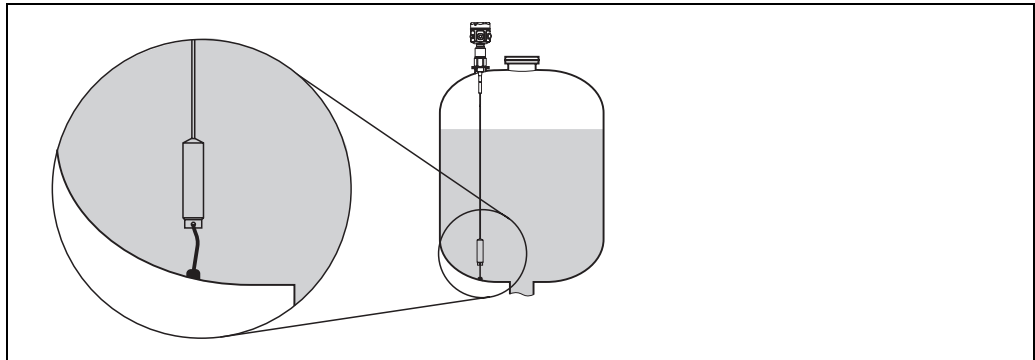

L00-FMI5xxxx-11-06-xx-xx-012

3.7 With separate housing

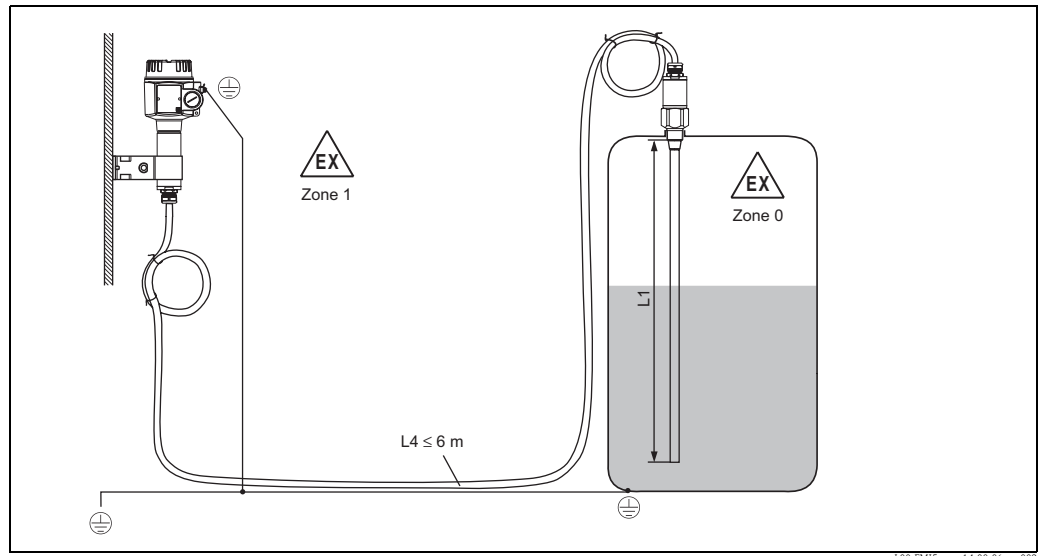

Rod length $L1$ max. 4 m

Rope length $L1$ max. 9.7 m (the maximum total length of $L1 + L4$ should not exceed 10 m).



Note!

- The maximum cable length between probe and separate housing is 6 m ($L4$). The required cable length must be indicated in the ordering process of a Liquicap M with separate housing.
- The total length $L = L1 + L4$ should not exceed 10 m (e.g. for rope probes).
- If the cable connection has to be shortened or led through a wall, it must be separated from the process connection.
- For information on ordering, please refer also to the "Ordering information" => "Probe design" on → 5ff.

3.7.1 Extension heights: separate housing

Housing side: wall mounting

Housing side: pipe mounting

Sensor side

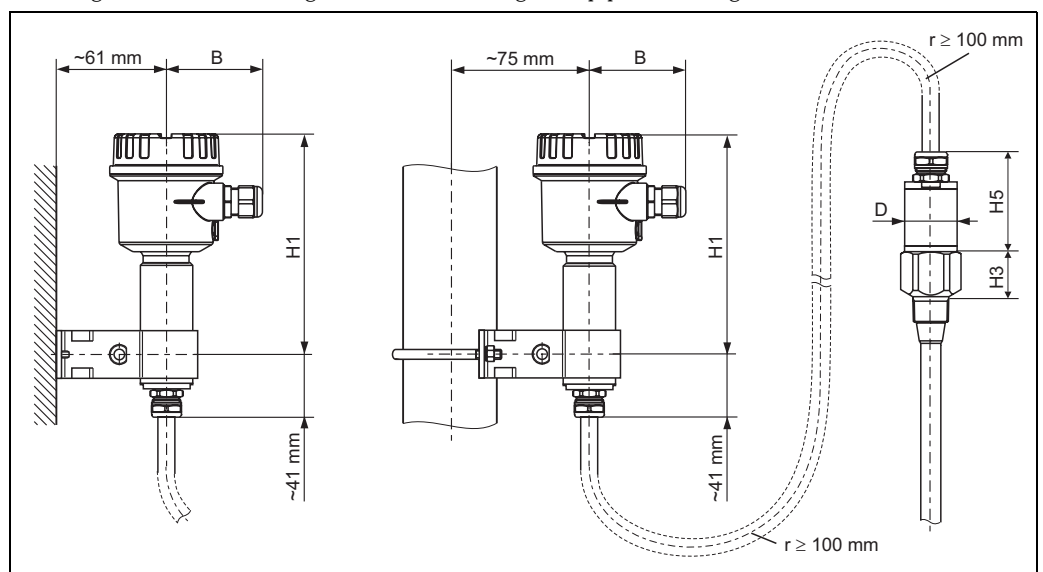

Note!

- The cable has a bending radius of $r \geq 100$ mm. This must be observed as a minimum!
- Connecting cable: $\varnothing 10.5$ mm
- Outer jacket: silicone, notch resistance

	Polyester housing (F16)	Stainless steel housing (F15)	Aluminum housing (F17)
B (mm)	76	64	65
H1 (mm)	172	166	177

		H5 (mm)	D (mm)
Probes Ø10 mm rod		66	38
Probes Ø16 mm rod or rope (without fully insulated inactive length)	G¾", G1", NPT¾", NPT1", Clamp 1", Clamp 1½", Universal Ø44, flange <DN 50, ANSI 2", 10K50	66	38
	G1½", NPT1½", Clamp 2", DIN 11851, flanges ≥DN 50, ANSI 2", 10K50	89	50
Probes Ø 22 mm rod or rope (with fully insulated inactive length)		89	38

3.7.2 Wall bracket



Note!

- The wall bracket forms part of the scope of delivery.
- The wall bracket first has to be screwed to the separate housing before you can use it as a drilling template. The distance between the holes is reduced by screwing it to the separate housing.

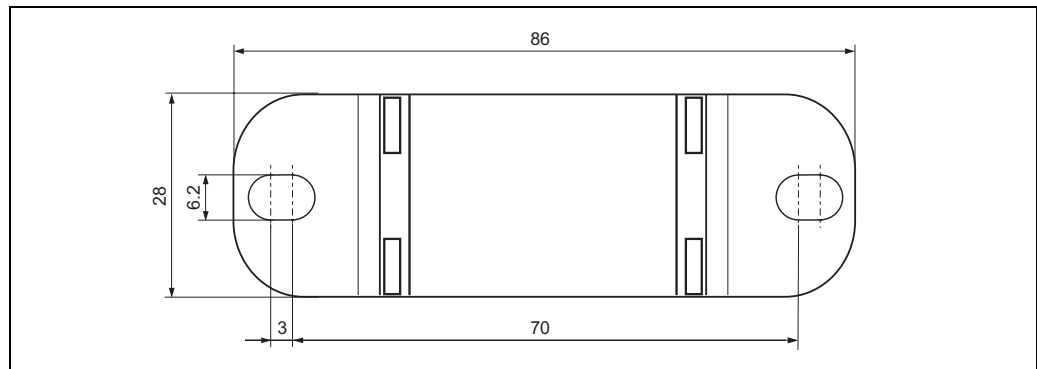

T1418F20

3.7.3 Wall mounting

- Push the wall bracket onto the tube and screw it together.
- Mark the distance between the holes on the wall and drill the holes.
- Screw the separate housing on the wall.

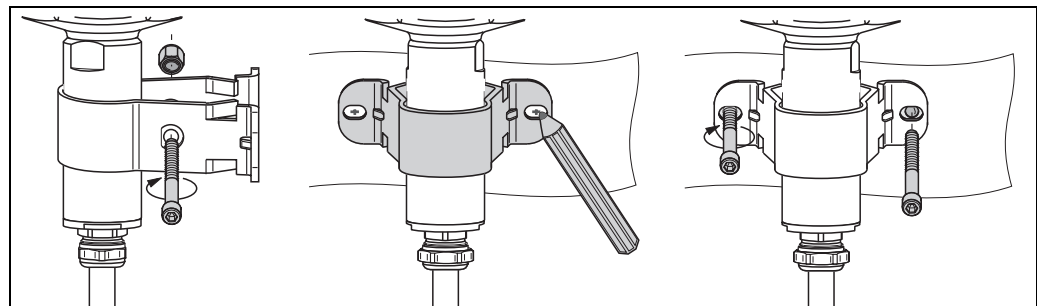

L00-FMI5xxxx-03-05-xx-xx-010

3.7.4 Pipe mounting

- Push the wall bracket onto the tube and screw it together.
- Screw the separate housing on a pipe of max. 2”.

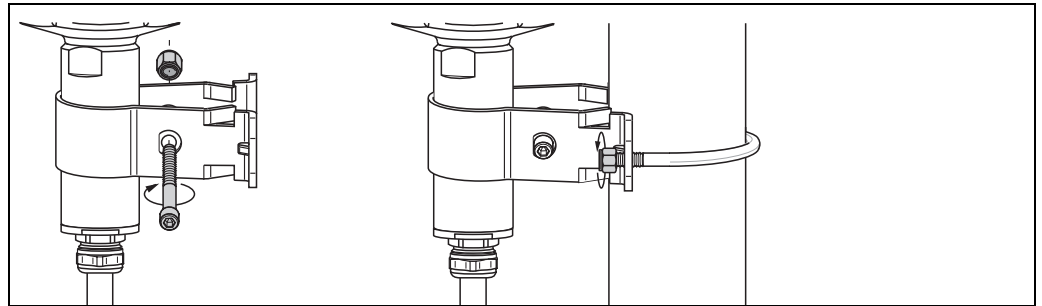

L00-FMI5xxxx-03-05-xx-xx-011

3.7.5 Shortening the connecting cable

Recalibration must be performed before commissioning → 47



Note!

The maximum connection length between the probe and the separate housing is 6 m. When ordering a device with a separate housing, the desired length must be specified.

If the cable connection has to be shortened or led through a wall, it must be separated from the process connection. Please proceed as follows:

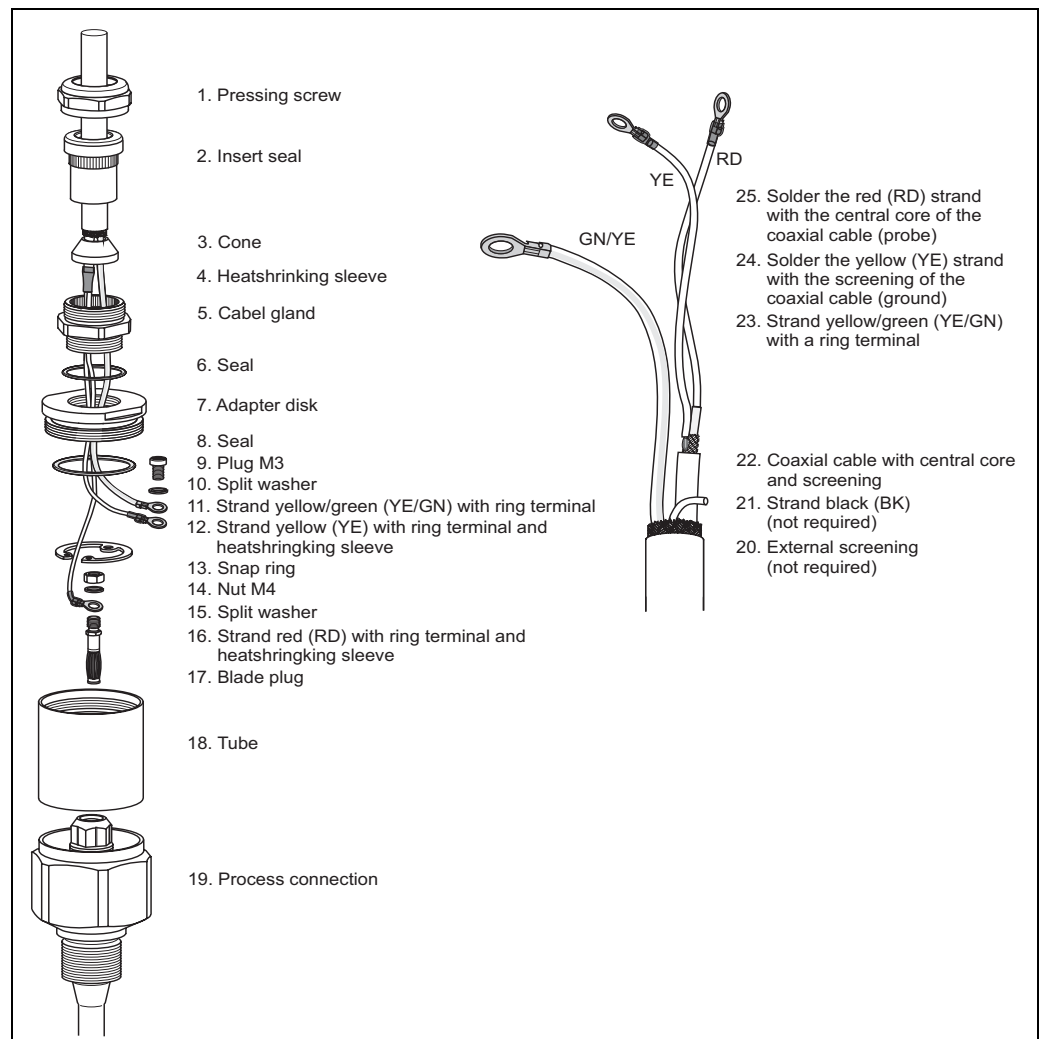

L00-FMI5xxxx-03-05-xx-en-005

- Loosen the pressing screw (1) with an open-end wrench (AF22). If necessary, hold the process connection. Please make sure that neither the connecting cable nor the probe is turning with the pressing screw.
- Pull the insert seal (2) out of the cable gland (5).
- Using an open-end wrench (AF22), disconnect the cable gland (5) from the adapter disk. If necessary, hold it against the adapter disk (7) using an open-end wrench AF34.
- Loosen the adapter disk (7) from the tube (18).
- Remove the snap ring (13) with a pair of snap ring pliers.
- Clutch the nut (M4) of the blade plug with a pair of pliers and pull this out.



Note!

- If you are shortening the connecting cable, we recommend to reuse all strands with ring terminals.
- If the strands are not to be reused, the crimp connections of the new ring terminals fitted must be isolated with a heat shrinking sleeve (risk of short-circuiting).
- All soldered joints must be insulated. Use heat-shrink tubes to do so.

3.8 Installation instructions



Caution!

- Do not damage the probe insulation when installing!
- When screwing in the probe, do not turn at the housing as this could damage the housing mounting.

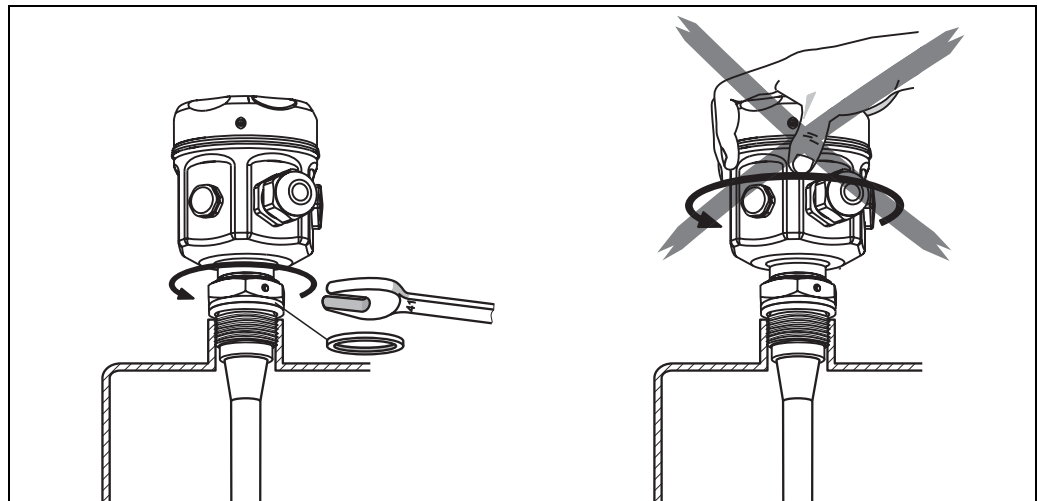

L00-FMI5xxxx-17-00-00-xx-003

Probe with thread

G 1/2, G 3/4, G 1 or G 1 1/2 (cylindrical):

To be used with the elastomer fiber seal supplied (pay attention to temperature resistance) or another chemically resistant seal.



Note!

The following applies for probes with a parallel thread and supplied seal:

Thread	For pressures up to 25 bar	For pressures up to 100 bar	Maximum torque
G 1/2	25 Nm	-	80 Nm
G 3/4	30 Nm	-	100 Nm
G 1	50 Nm	-	180 Nm
G 1 1/2	-	300 Nm	500 Nm

1/2 NPT, 3/4 NPT, 1 NPT and 1 1/2 NPT (conical):

Wrap the thread by a suitable sealing material (Use conductive sealing material only).

Probe with Tri-Clamp, sanitary connection or flange

- The process seal must meet the specifications of the application (resistant to temperature and medium).
- If the flange is PTFE-clad, this generally suffices as the seal up to the permitted operating pressure.

Probe with PTFE-clad flange

Note!

Use spring washers (1).

It is recommended to retighten the flange bolts periodically, depending on process temperature and pressure. Recommended torque: 60 to 100 Nm.

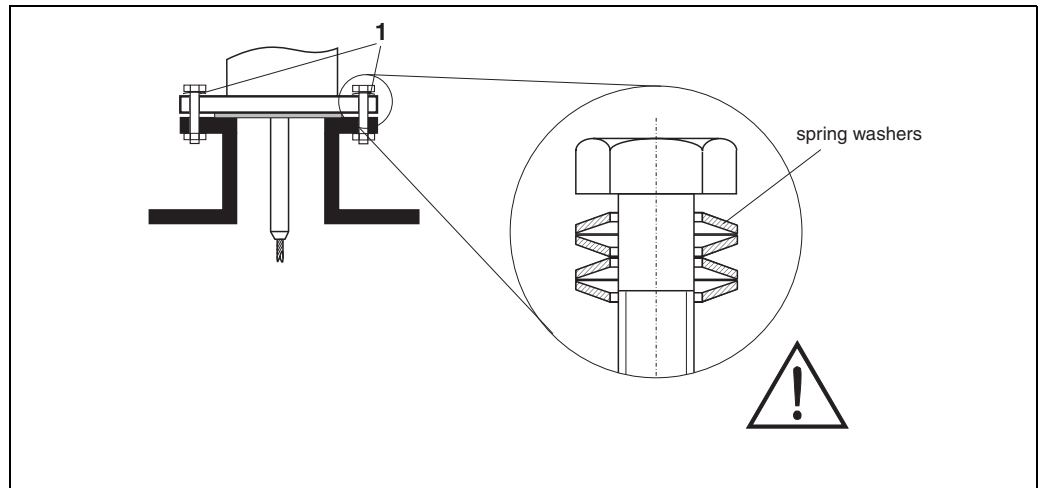

L00-FMI5xxxx-17-00-00-en-005

3.8.1 Aligning the housing

The housing can be rotated 270° to align the cable entry.

For an even better way of preventing moisture penetration, we recommend you route the connecting cable downwards before the cable gland and secure it with a cable tie. This is particularly recommended when mounting outdoors.

Housing (type F16, F15, F17, F13, T13)

- Unscrew cover
- Loosen Phillips screw at bottom of housing by turning the screw 3 to 4 times
- Turn the housing to the desired position (max. 270°, from one stop to the next)
- Tighten Phillips screw at bottom of housing.



Note!

For housing type T13 with a separate connection compartment, the Phillips screw for aligning the housing is also located in the electronics compartment.

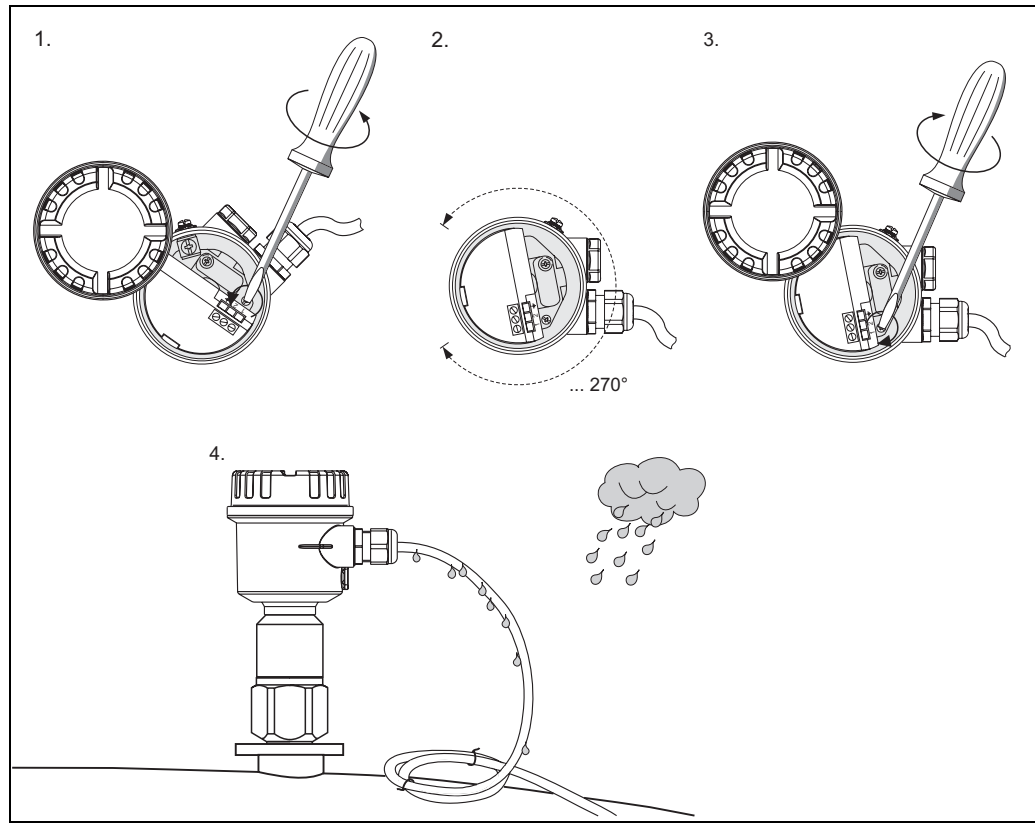

1. Loosen clamping screw until the housing rotates easily.
2. Align the housing.
3. Tighten clamping screw (< 1 Nm) until the housing can no longer be rotated.
4. Additional protection against moisture penetration for electronics compartment.

3.8.2 Sealing the probe housing

No water should enter the device when performing installation, connection and configuration tasks. Always seal the housing cover and cable entries securely.

The O-ring seal on the housing cover is shipped with a coat of special lubricant applied. In this way, the cover can be sealed tight and the aluminum thread does not bite when screwing down. Never use mineral oil-based grease as this destroys the O-ring.

3.9 Post-installation check

After installing the measuring device, carry out the following checks:

- Is the device damaged (visual inspection)?
- Does the device meet the specifications at the measuring point with regard to process temperature/pressure, ambient temperature, measuring range etc.?
- Has the process connection been tightened with the appropriate tightening torque?
- Are the measuring point number and labeling correct (visual inspection)?
- Is the device adequately protected against precipitation and direct sunshine?

3.9.1 Measuring range with FEI50H (HART)

- Measuring frequency: 500 kHz
- Span: $\Delta C = 25$ to 4000 pF recommended (2 to 4000 pF possible)
- Final capacitance: $C_E = \text{max. } 4000 \text{ pF}$
- Adjustable initial capacitance:
 - $C_A = 0$ to 2000 pF (< 6 m probe length)

– $C_A = 0$ to 4000 pF (> 6 m probe length)

4 Wiring



Caution!

Before connecting the supply voltage, note the following:

- The supply voltage must match the data specified on the nameplate (1).
- Switch off the supply voltage before connecting the device.
- Connect the potential equalization to the ground terminal on the sensor.



Note!

- When using the probe in hazardous areas, the relevant national standards and the information in the safety instructions (XA) must be observed.
- Use the specified cable gland only.

4.1 Recommendations for connection

4.1.1 Potential equalization



Caution!

In Ex-applications, the screen may only be grounded on the sensor side.

Connect the potential equalization to the outer ground terminal of the housing (T13, F13, F16, F17, F27). In the case of the stainless steel housing F15, the ground terminal (depending on the version) can also be located in the housing.

For further safety instructions, please refer to the separate documentation for applications in hazardous areas.

4.1.2 Electromagnetic compatibility (EMC)

Interference emission to EN 61326, Electrical Equipment Class B. Interference immunity to EN 61326, Annex A (Industrial) and NAMUR Recommendation NE 21 (EMC).

4.1.3 Cable specification

The electronic inserts can be connected using commercially available instrument cables.

When using shielded instrument cables, it is recommended to connect the shielding on both sides to optimize the shielding effect (if potential equalization is present).

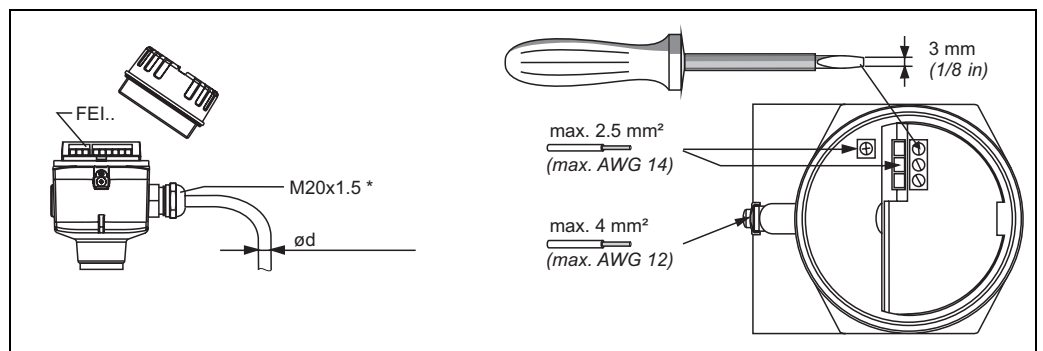

* Cable entries

Nickel-plated brass: $\varnothing d = 7$ to 10.5 mm (0.28 to 0.41 in)

Synthetic material: $\varnothing d = 5$ to 10 mm (0.2 to 0.38 in)

Stainless steel: $\varnothing d = 7$ to 12 mm (0.28 to 0.47 in)

4.1.4 Connector

For the version with a connector M12, the housing does not have to be opened for connecting the signal line.

PIN assignment for M12 connector

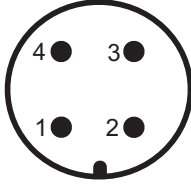
 <p>L00-FM15xxxx-04-00-xx-xx-015</p>	PIN	2-wire-electronic insert: FEI50H
	1	+
	2	not used
	3	-
	4	ground

4.1.5 Supply voltage

All of the following voltages are terminal voltages directly at the device:

- 12.0 to 36 VDC (in the non-hazardous area)
- 12.0 to 30 VDC (in EEx ia hazardous areas)
- 14.4 to 30 VDC (in EEx d hazardous areas)

4.2 Wiring and connecting

Connection compartment

Determining the explosion protection:

Housing	Standard	EEx ia	EEx d	Gas-tight process seal
Polyester housing F16	X	X	-	-
Stainless steel housing F15	X	X	-	-
Aluminum housing F17	X	X	-	-
Aluminum housing F13	X	X	X	X
Stainless steel housing F27	X	X	X	X
Aluminum housing T13 (with separate connection compartment)	X	X	X	X

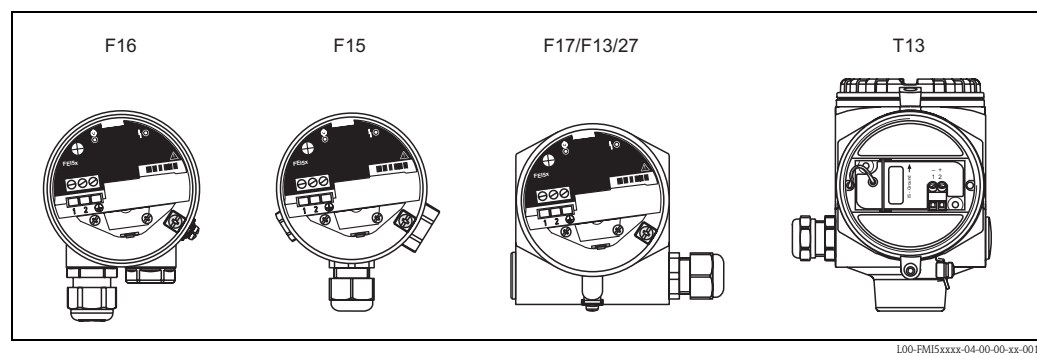

To connect the electronic insert to the power supply, proceed as follows:

- a. Unscrew the housing cover (1).
- b. Release the cable gland (2) and insert the cable (3).

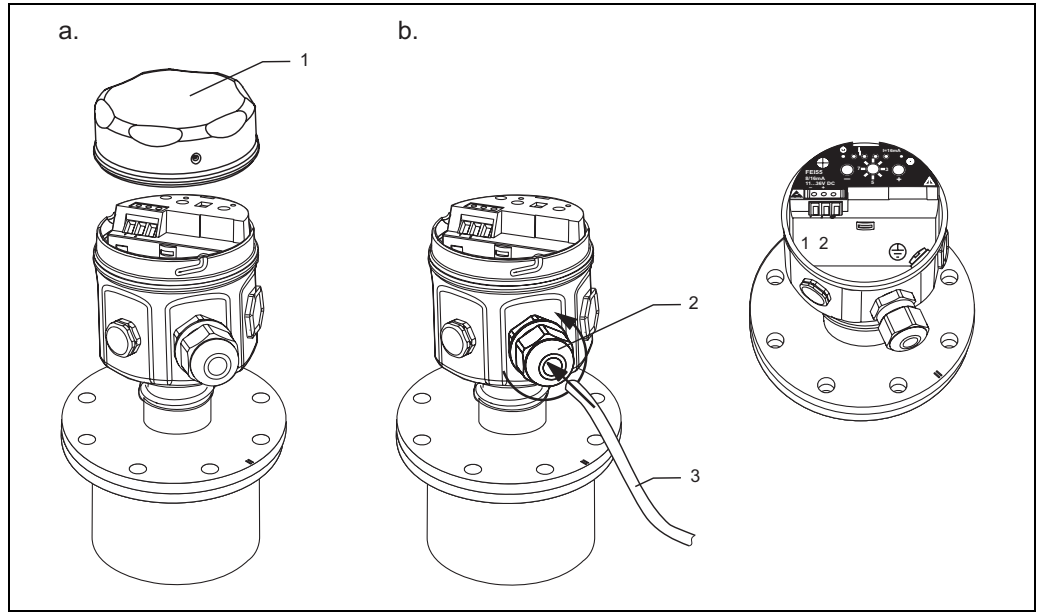

L00-FT15xxxx-04-06-xx-xx-003

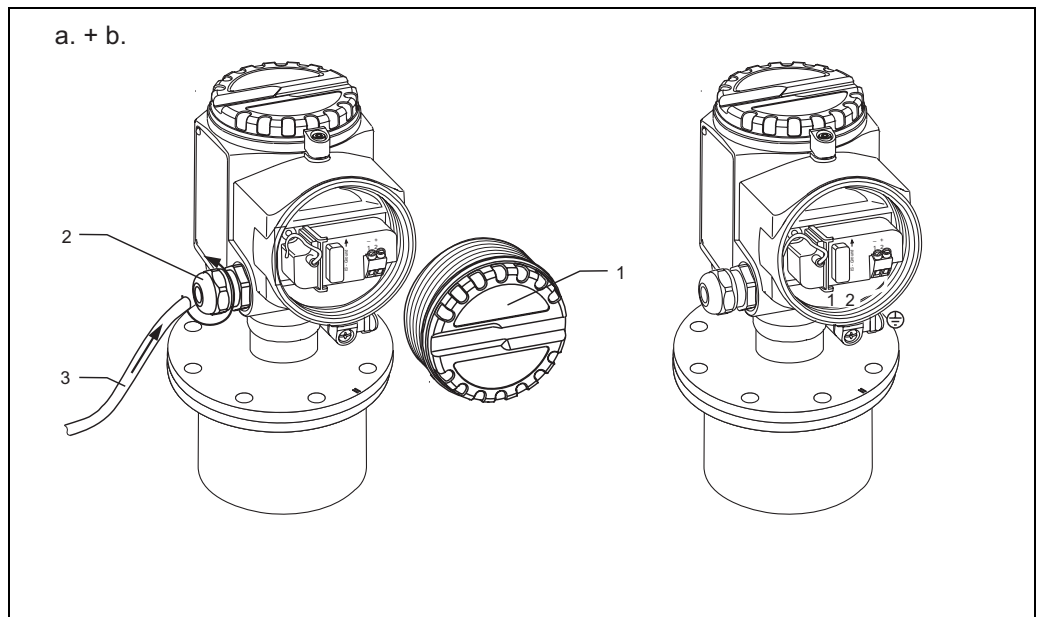

L00-FT15xxxx-04-06-xx-xx-004

Information on connecting shielded cables is provided in TI241 "EMC test procedures".

4.2.1 Terminal assignment

2-wire, 4 to 20 mA with HART

The twin-core connecting cable is connected to the screw terminals (conductor cross-section 0.5...2.5 mm) in the connection compartment at the electronic insert. If the superimposed communication signal (HART) is used, a screened cable must be used and the screening connected at the sensor and power supply.

Protective circuits against reverse polarity, HF influences and overvoltage peaks are integrated (see TI241F "EMC test procedures").

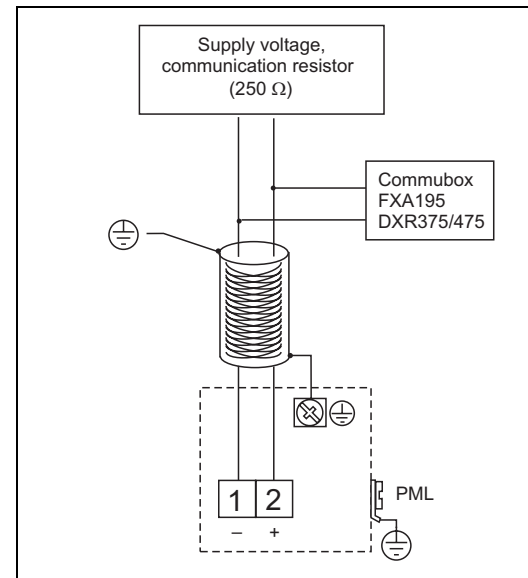

4.2.2 Connecting HART with other supply units

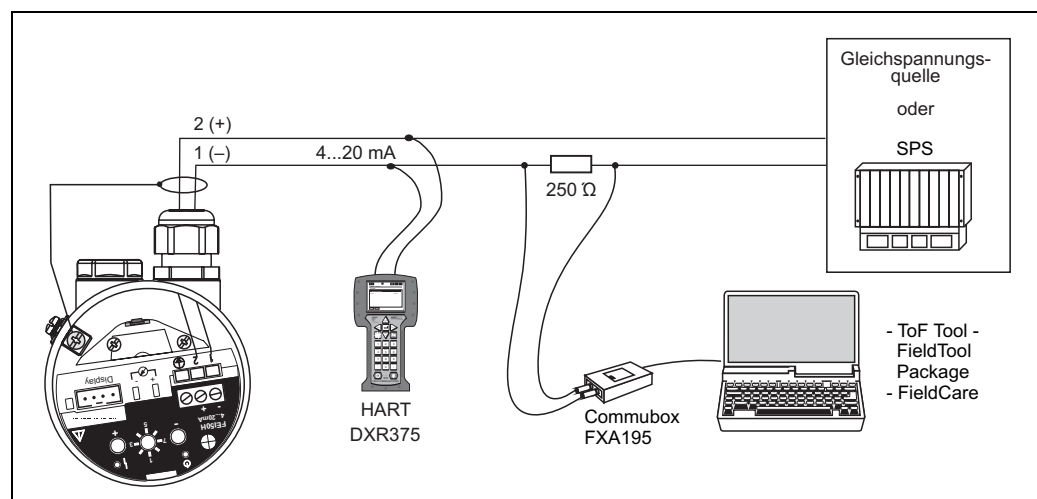

Caution!

If the HART communication resistor is not integrated in the supply unit, a 250 Ω communication resistor must be included in the 2-wire line.

4.3 Post-connection check

After wiring the measuring device, carry out the following checks:

- Is the terminal assignment correct (→ 30 ff.)?
- Is the cable gland sealed tight?
- Is the housing cover screwed down until the stop?
- If power supply is present:
 - Is the device operational and is the green LED flashing?

5 Operation

5.1 Operating options

- Via the operating elements at the FEI50H electronic insert
- Via the display and operating module
- Via the HART protocol with Commubox FXA195 and FieldCare operating program
- With the HART handheld terminal DXR375

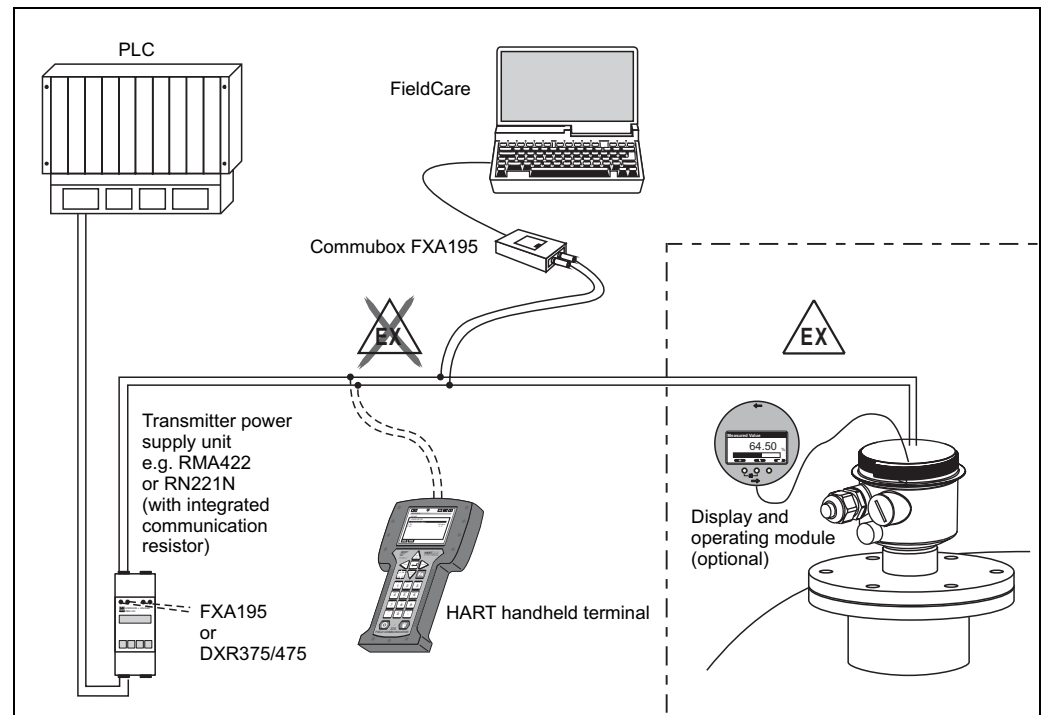

L00-FMI5xxxx-14-00-06-en-001

5.1.1 Display and operating elements at the FEI50H electronic insert

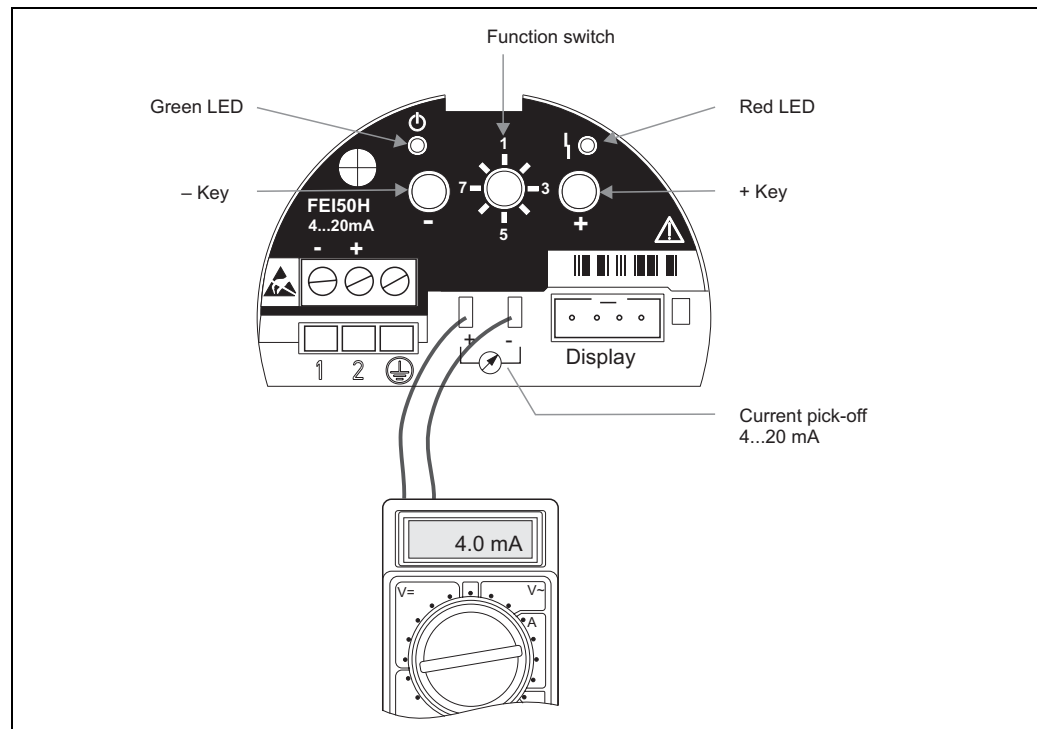

L00-FMI5xxxx-07-05-xx-en-100

Green LED (Ⓞ indicates operation):

- Flashes every 5 s:
 - Indicates whether the device is operational.
- Flashes once every s:
 - The device is in the calibration mode

Red LED (Ⓛ indicates a fault or malfunction):

- Flashes five times a s:
 - Capacitance at probe is too large, short-circuit at the probe or FEI50H is defective
- Flashes once every s:
 - The temperature in the electronic insert is outside the permitted temperature range.

Key (-)

- To execute the functions set via the function switch

Key (+)

- To execute the functions set via the function switch

Function switch

- 1 : Operation
 - Switch position for normal operation
- 2 : Empty calibration
 - Empty calibration is carried out in this operating mode.
- 3 : Full calibration
 - Full calibration is carried out in this operating mode.
- 4 : Measuring modes
 - In this operating mode, chose between operation for media that form buildup (e.g. yoghurt) or for media without buildup (e.g. water).
- 5 : Measuring range
 - In this operating mode, select the measuring range in pF for:
 - => Measuring range probe length < 6 m (corresponds to 2000 pF)
 - => Measuring range probe length > 6 m (corresponds to 4000 pF)
- 6 : Self-test
 - In this operating mode, you can activate the self-test.

- 7 : Reset (factory settings)
 - In this operating mode, you can restore the data of the factory settings.
- 8 : Upload sensor DAT (EEPROM)
 - In this operating mode, you can:
 - => Transfer the calibration values in the electronic insert to the sensor DAT (EEPROM) if replacing the probe
 - => Transfer the calibration values of the sensor DAT (EEPROM) to the electronics if replacing the electronic insert

Display connection

- For onsite display and operation (optional)
 - Display and operating module

4 to 20 mA current pick-off

- E.g. for full/empty calibration with multimeter .
(No need to disconnect circuit!)





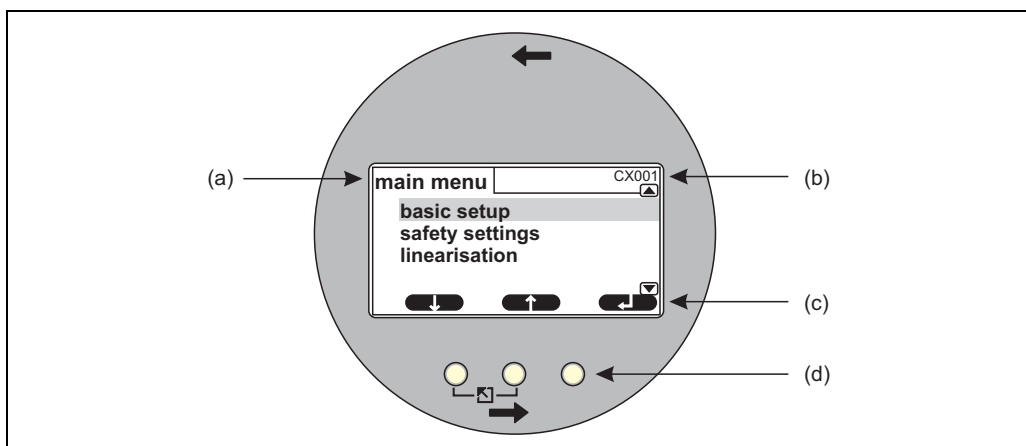

5.1.2 Operation via the optional display and operating module

Display and operating elements











(a): Name of what is being displayed, e.g. Main menu view; (b): Item code of function displayed; (c): Softkey symbols; (d): Keys

Display symbols

Symbol	Meaning
Operating mode of the device	
	User User parameters can be edited.
	Locked All parameters are locked.
 	Scrollbar This symbol tells you whether you can scroll up or down to get to more functions other than those shown on the display.
Locking state of the currently displayed parameter	
	Display parameter The parameter cannot be edited in the current operating mode of the device.
	Write parameter The parameter can be edited.



Keys (softkey operation)

The keys work as softkeys. This means that their function and meaning depends on the current position in the operating menu. The key functions are indicated by softkey symbols in the bottom line of the display.

Symbol	Meaning
	Down Moves the bar downwards in a picklist.
	Up Moves the bar upwards in a picklist.
	Enter <ul style="list-style-type: none"> ■ Enter the selected submenu or selected function. ■ Confirm the edited function value.
	Previous function Go to the previous function within the function group.
	Next function Go to the next function within the function group.
	Confirm selection From the picklist, select the option the bar is currently on.
	Increase value Increases the selected position of an alphanumeric function.
	Decrease value Decreases the selected position of an alphanumeric function.
	Error list Opens the list of the errors currently present. The symbol is inverted and flashes if a warning is present. The symbol appears constantly if an alarm is present.

General key combinations

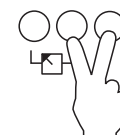
The following key combinations apply regardless of the menu item in question:

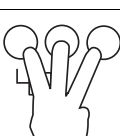
Key combinations	Meaning
	Escape <ul style="list-style-type: none"> ■ When editing a function: exits the editing mode for the current function. ■ When navigating: returns to the next-highest menu level.
	Increase contrast Increases the contrast of the display module.
	Decrease contrast Decreases the contrast of the display module.
	Locking Locks the device against parameter changes. Locking can only be reversed by entering a release code.

5.1.3 The operating menu

Function codes

The functions of Liquicap M are arranged in an operating menu. A 5-digit item code is shown on the display for every function to aid orientation within the menu.

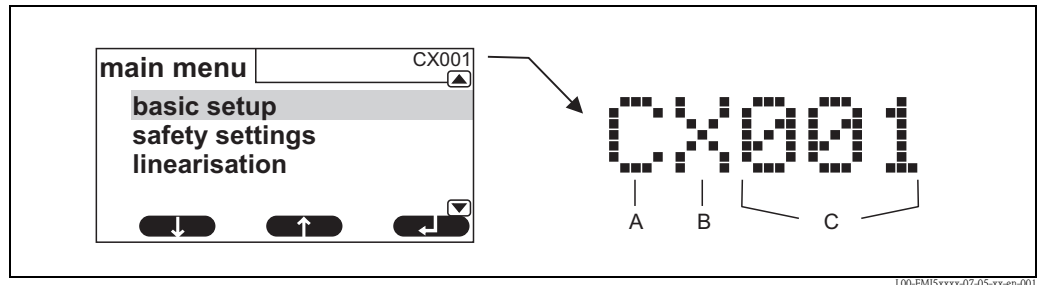

A: Function group; B: Channel; C: Number of the function within the group

- The first position (A) refers to the function group¹⁾:
 - **C: Basic setup**
 - **S: Safety setting**
 - **L: Linearization**
 - **O: Output**
 - **D: Device properties**
- The second position (B) is without function.
- The last three positions (C) refer to the individual functions within the function group.

1) The function groups available depend on the device version, the installation environment and the operating mode selected.

Navigating in the menu - Basic setup example

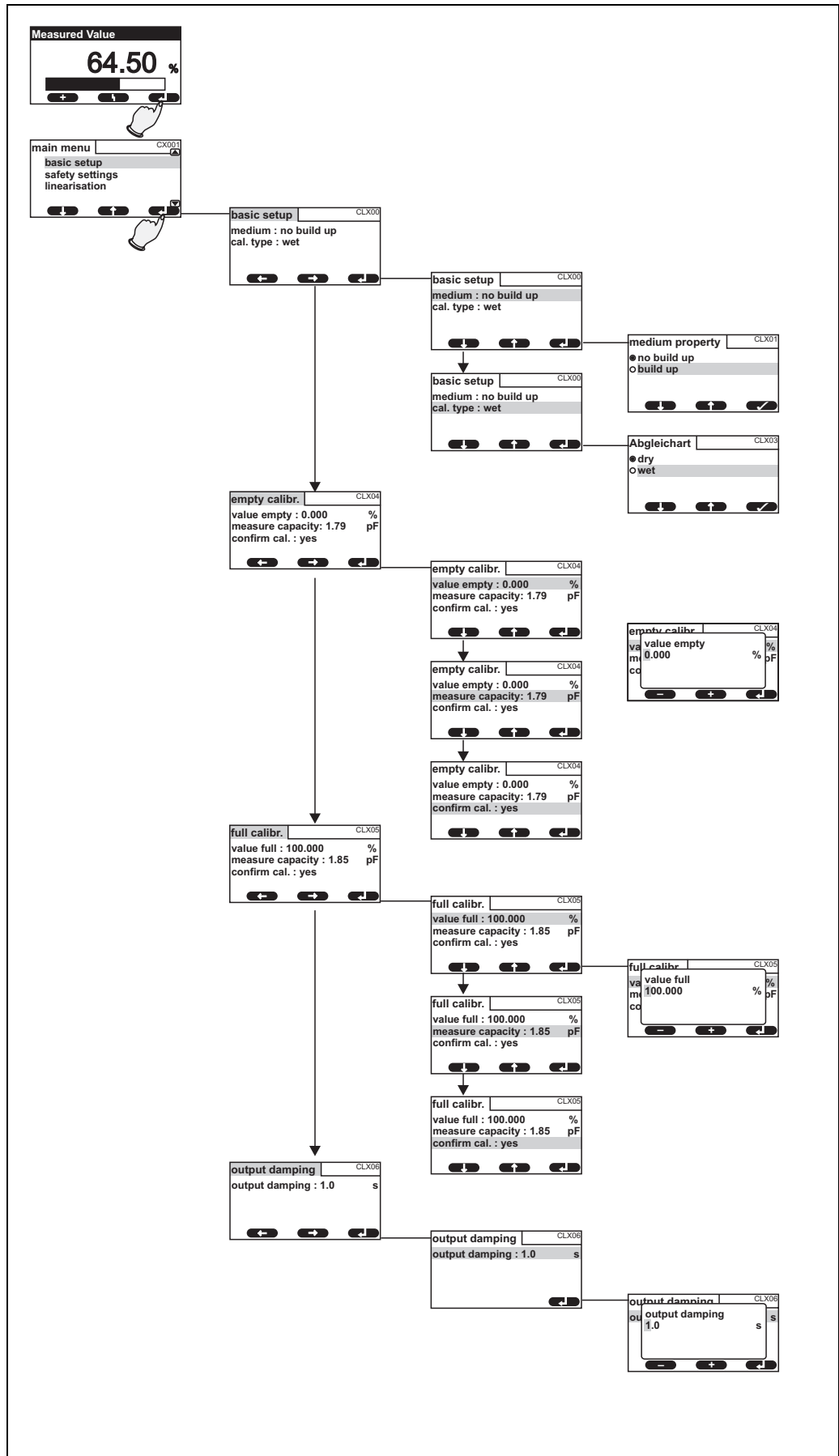

L00-FMI5xxxx-05-06-zx-en-002

Launching menus



Note!

If you are within a submenu and do not press a key for 15 minutes, the display automatically switches to the main screen (measured value).

Navigation always starts with the main screen (measured value display). From here, you can go to the following menus with the aid of the keys:

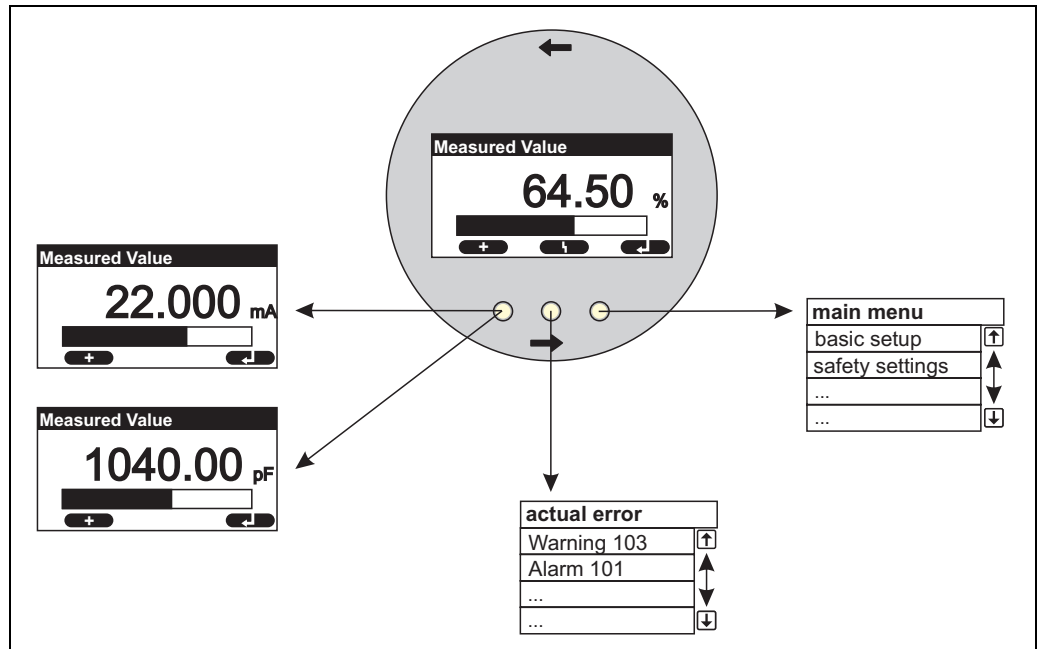

L00-FMI5xxxx-19-05-xx-en-011

■ Measured value

Displays the measured value in %, mA or pF.

■ Main menu

The main menu contains all the parameters of Liquicap M. It is split into submenus. Some of the submenus themselves have additional submenus.

An overview of the submenus and the functions they contain is provided in the "Commissioning" section.

■ Actual errors

If the automatic monitoring function of Liquicap M detects an error, the related softkey symbol appears over the center key.

If the softkey symbol is flashing, only "Warning"-type errors are present²⁾.

If the symbol is displayed continuously, at least one "Alarm"-type error is present²⁾.

Once you press the key, a list appears with all the errors currently pending.

2) See Section 9.2, "System error messages" for information on the difference between a "Warning" and an "Alarm".

Selecting a submenu

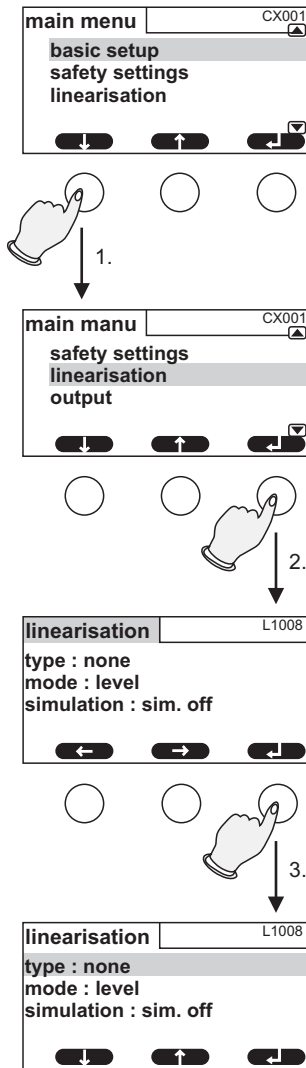

1. Press or until the desired submenu is selected.
2. Press to enter the selected submenu.
3. If the submenu contains additional submenus, continue in the same manner until you reach the function level. The softkey symbols and then appear.

L00-FMI5xxxx-19-05-xx-en-001



Note!

You can return to the next-highest menu level any time by pressing .

Selecting a function and subfunction

Once you have reached the function level, you can navigate through the functions with \leftarrow and \rightarrow . The current values of all the related subfunctions are displayed. Proceed as follows to change a value:

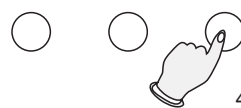
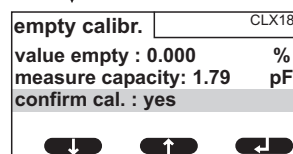
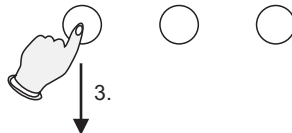
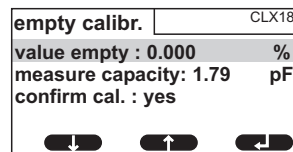
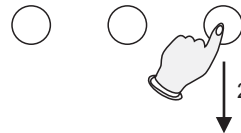
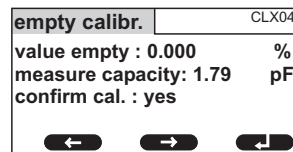
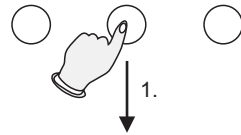
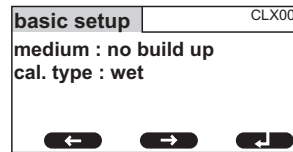

L00-FMI5xxxx-19-05-xx-en-002

1. Press \leftarrow or \rightarrow until you reach the desired function.

2. Press \downarrow to enter the selected function.

3. Use \uparrow and \downarrow to select the desired subfunction. (This step is not necessary if the function only has one subfunction.)

4. Press \leftarrow to enter the subfunction. The editing process that follows depends on the type of subfunction selected (picklist, numeric function or alphanumeric function). Details are explained in the following sections.



Note!

You can leave the function at any time and return to the next-highest menu level by pressing



Editing functions with the picklist

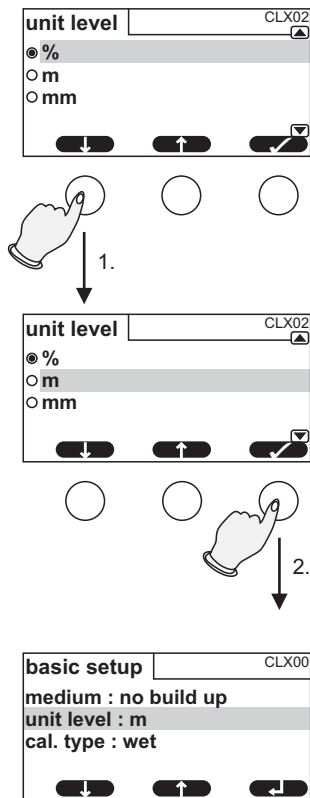

1. Press or until the bar is on the desired option (here: "m").
2. Press to select this option. The new value is now transferred to the device. If required, you can edit another subfunction in the same way.

L00-FMI5xxx-19-05-zx-en-003



Note!

You can leave the function at any time and return to the next-highest menu level by pressing .

Editing numeric and alphanumeric functions

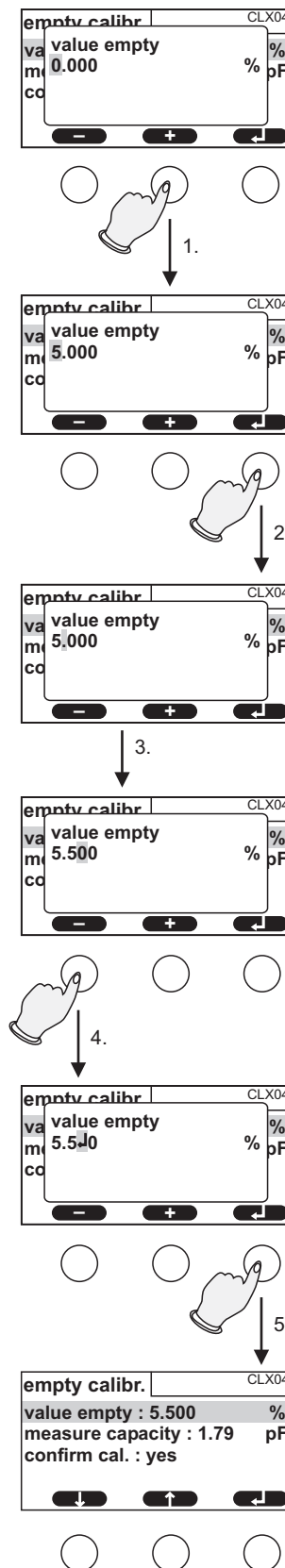

If you select a numeric function ("Empty calibration", "Full calibration" etc.) or an alphanumeric function ("Device marking" etc.), the editor for numbers/ alphanumeric characters opens.

Enter the desired value as follows:

1. The marker is on the first position. Press \leftarrow or \rightarrow until this position shows the desired value.
2. Press \downarrow to enter the value and go to the next position.
3. Follow the same procedure for the positions that follow.
4. Once all the necessary positions have been entered, press \leftarrow or \rightarrow until \downarrow appears at the marker.
5. Press \downarrow to transfer the entire value to the device.

Special functions when making entries

In the editor for numbers and alphanumeric characters, the \square and \square keys not only call up numbers and letters but also call up the following symbols for special editing tasks which make inputting information easier and make it possible to make corrections quickly.

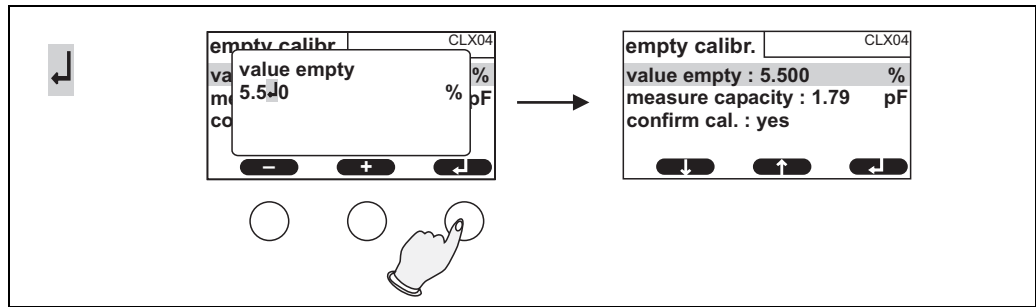

L00-FMI5xxxx-19-05-xx-en-005

Enter: The number to the left of the marker is transferred to the device.

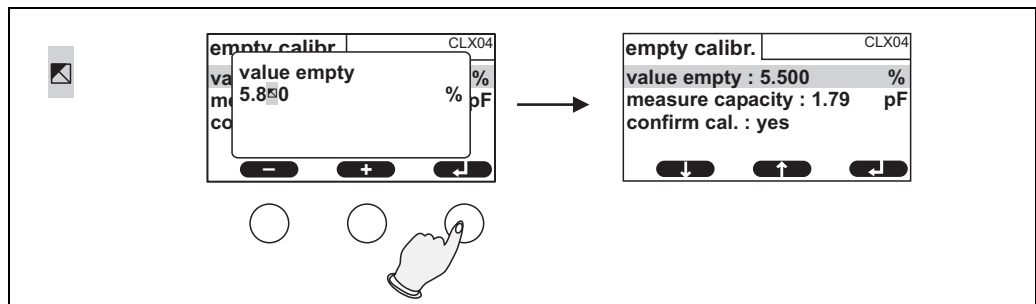

L00-FMI5xxxx-19-05-xx-en-006

Escape: You exit the editor. The old function value remains.

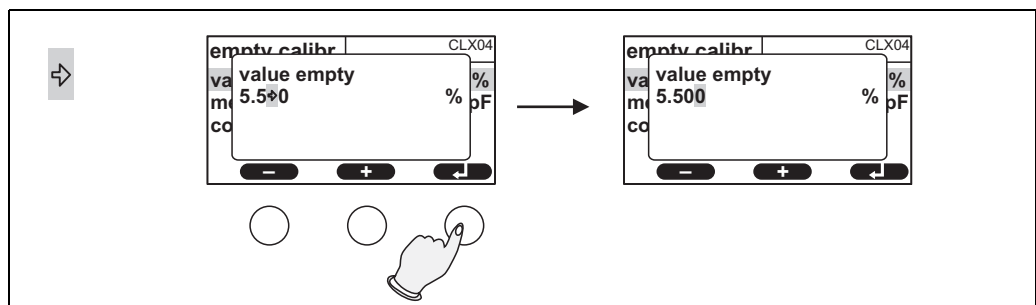

L00-FMI5xxxx-19-05-xx-en-007

Next position: The marker jumps to the next position.

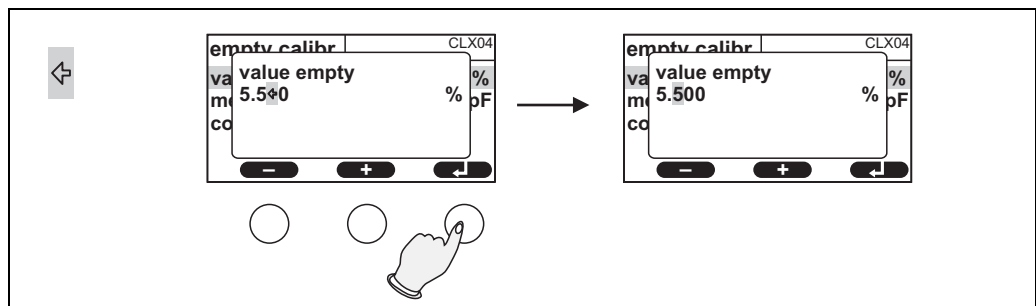

L00-FMI5xxxx-19-05-xx-en-008

Previous position: The marker jumps back to the previous position.

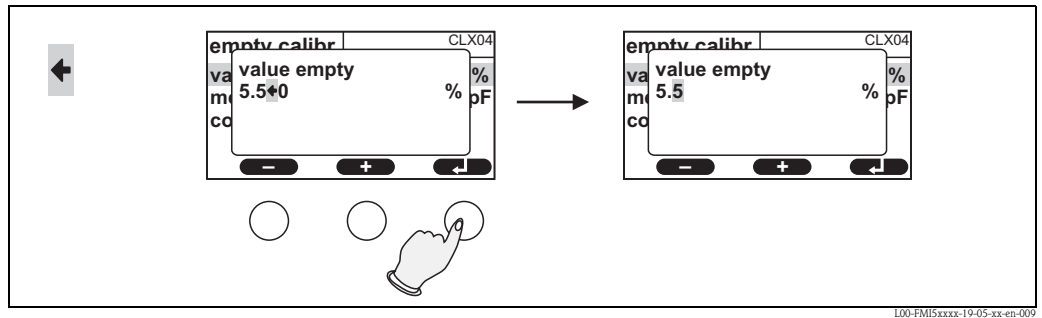

L00-FMI5xxxx-19-05-xx-en-009

Delete: The current position and all positions to the right of this position are deleted.

Return to the measured value display

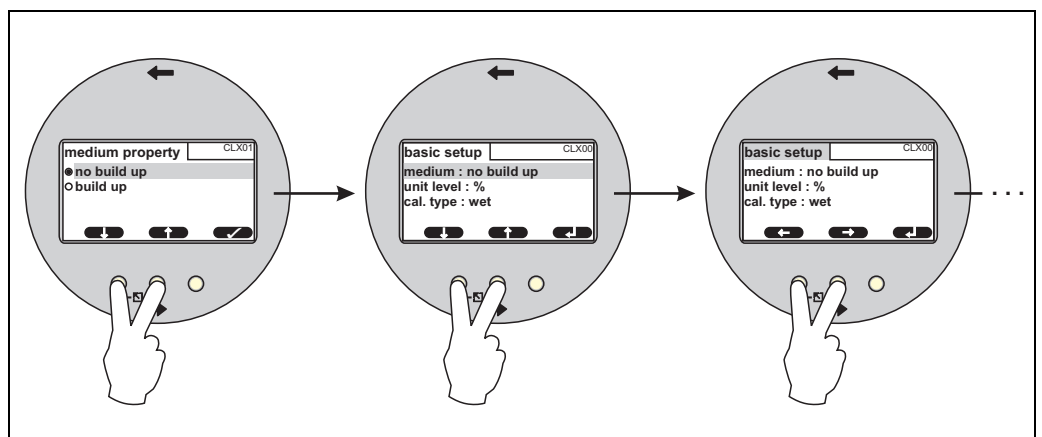

L00-FMI5xxxx-19-05-xx-en-010

Pressing the left and center key simultaneously has the following effect:

- Takes you from the editing mode to the display mode of the functions
- Takes you from the display mode of the functions to the submenu
- Takes you from the submenu to the main menu
- Takes you from the main menu to the measured value display.

5.2 Error messages

If the automatic monitoring function of Liquicap M detects an error, the related softkey symbol \downarrow appears over the center key.

If the softkey symbol \downarrow is flashing, only "Warning"-type errors are present³⁾.

If the symbol is displayed continuously, at least one "Alarm"-type error is present³⁾.

Once you press the key, a list appears with all the errors currently pending.

3) See Section 9.2, "System error messages" for information on the difference between a "Warning" and an "Alarm".

5.3 Locking/unlocking configuration

5.3.1 Key locking

Press all three keys simultaneously. The device is then locked against entries.

5.3.2 Key unlocking

Press all three keys simultaneously. The device is then unlocked.

5.3.3 Software locking

Locking

Go to the "Safety settings" function.

In the menu, the current locking status of the device is displayed in the "Status" subfunction under "Safety settings" (SAX01). The following values can appear:

- **Unlocked**

All parameters can be modified.

- **Locked**

The device has been locked by means of the operating menu. It can only be enabled again by entering "100" in the "Safety settings" function.

If an attempt is made to change a parameter, the device goes to the "Safety settings" function. "Key locking" is displayed in the "Status" subfunction. Press all the keys simultaneously. The device then goes back to the original function and all the parameters can be changed again.

- **Key locked**

The device has been locked by means of the operating keys. It can only be enabled again by pressing all three keys simultaneously.



Note!

A key symbol is shown on the display when locked.

5.4 Resetting to factory setting (reset)



Caution!

The reset can affect the measurement as the current values are overwritten by those of the factory calibration 0 % (4 mA) and 100 % (20 mA).

Using the reset

A reset is always recommended if a device with an unknown history is to be used.

Effects of a reset

- All parameters are reset to the factory setting.
- The linearization is reset to "linear". However, any linearization table available is retained and can be activated again where necessary.



Note!

The factory setting of the parameters is marked in bold in the menu overview (see the "Basic setup" menu ff.).

Performing a reset

To carry out a reset, enter the value "333" in the "Device properties/Diagnosis/Password reset/Reset" function.

5.5 Operation via FieldCare Device Setup

5.5.1 FieldCare Device Setup - operating program

FieldCare is a graphic operating program for Endress+Hauser measuring devices based on the time-of-flight principle. It is used to support commissioning, data back-up, signal analysis and documentation of the devices. The following operating systems are supported: Windows 2000, Windows XP, Windows Vista and Windows 7.

FieldCare supports the following functions:

- Configuration of transmitters in online operation
- Tank linearization
- Loading and saving device data (upload/download)
- Documentation of the measuring point



Note!

Further information on FieldCare is provided on the CD-ROM which is supplied with the device.

Menu-guided commissioning

The screenshot displays the FieldCare software interface for configuring a Liquicap M device. The top status bar shows the device type as 'Liquicap M', model as 'FMI 5x', and device marking as 'LIQUICAP-FMI5x'. The status is 'unlocked'. The main window is titled 'Language' and shows the 'measure capacity' configuration screen. The left sidebar contains a menu tree with 'measure capacity' selected. The central area shows a diagram of a tank with two measurement points: (1) at the top and (2) at the bottom. The right side of the screen contains configuration fields for 'measure capacity', '(1) value empty', 'confirm cal.', '(2) value full', 'confirm cal.', and 'output damping'. The status bar at the bottom indicates 'Offline' and 'basic setup 2/2'.

Connection options:

- HART with Commubox 195

5.6 Operation via HART handheld terminal DXR375

The handheld terminal DXR375 (Field Communicator) can be used to set all device functions via menu operation.

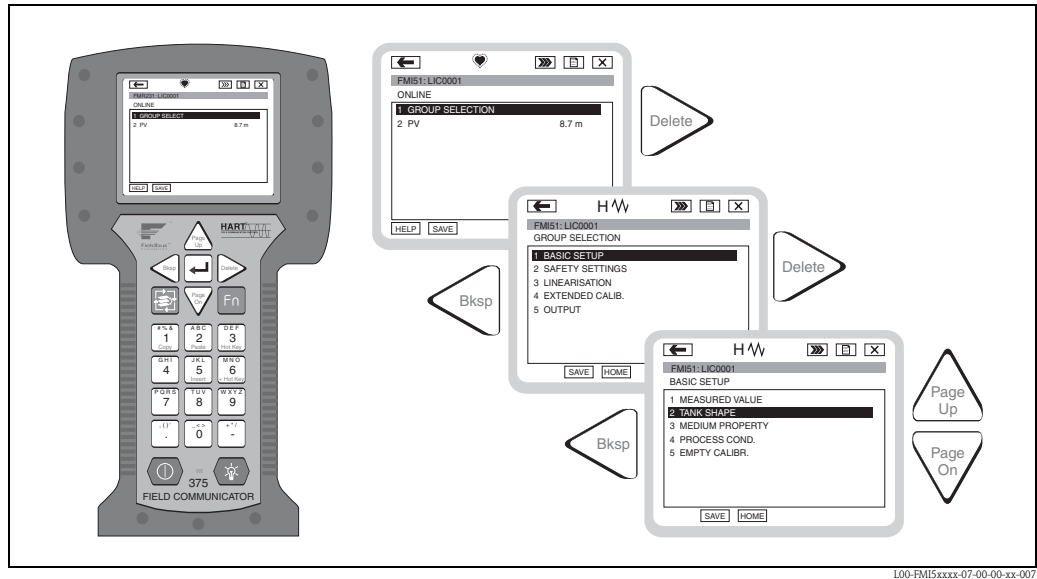

Menu operation with the DXR375 handheld terminal



Note!

- Further information on the HART handheld terminal can be found in the associated Operating Instructions which can be found in the carrying case for the device.

6 Commissioning



Note!

The device is operated via the electronic insert, the display or with FieldCare. If a display is attached to the electronic insert, the function keys (- key/ + key) and the Mode switch at the electronic insert are deactivated. All other settings can be made using the function keys on the display or with FieldCare.

6.1 Installation and function check

Make sure that the post-installation check and final check have been completed before you start your measuring point:

- See "Post-installation check" checklist → 26
- See "Post-connection check" checklist → 30

6.2 Basic setup without the display/operating module

This section describes how to commission the device with the function switch and the operating keys (-/+) on the FEI50H electronic insert.



Note!

- On leaving the factory, Liquicap M devices are calibrated for media with a conductivity of $\geq 100 \mu\text{S}/\text{cm}$ (e.g. for all water-based liquids, acids, alkalis ...). A recalibration is only necessary if the 0 %-value or the 100 %-value should be adjusted to suit customer-specific requirements, the distance to the tank wall is $< 250 \text{ mm}$ or if the liquid is not conductive.
- Only the "Wet" type of calibration can be carried out without the display and operating module.

During wet calibration ("Wet" operating mode), the 0 %-value and/or the 100 %-value is adjusted to customer-specific requirements. This calibration can be carried out if the tank is empty, full or partially full. During full calibration, the probe must be covered by liquid in the installed state. An empty and full calibration must be performed.

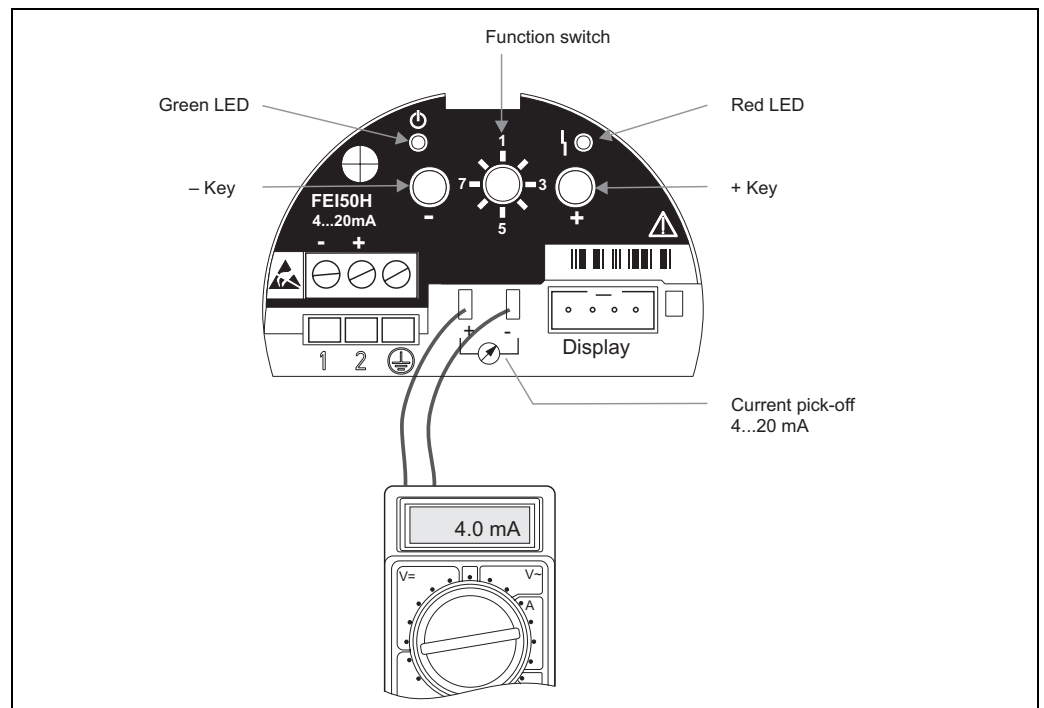

L00-FMI5xxxx-07-05-xx-en-100

6.2.1 Function switch - position 1 Operation

In normal operation, the function switch must be set to position **1**.

6.2.2 Function switch - position 4 Measuring modes



Note!

Before carrying out empty and full calibration, the medium properties must be configured. If the medium is conductive and tends to form buildup, the "Buildup" operating mode must be selected. In this operating mode, the buildup on the probe rod is compensated. The "No buildup" operating mode is set at the factory.

"Medium property" subfunction

The "**No buildup**" operating mode should be set for media that do not tend to form buildup on the probe rod (e.g. water, beverages etc.). As of a conductivity of 100 $\mu\text{S}/\text{cm}$ (i.e. all water-based liquids, acids, alkalis ...), the measured value is independent of the conductivity of the liquid (independent of concentration fluctuations).

In the "**Buildup**" operating mode, the buildup compensation function integrated in the software is activated. In this operating mode, the measured value is independent of the conductivity of the liquid as of a conductivity of 1000 $\mu\text{S}/\text{cm}$ (independent of concentration fluctuations). This compensates measuring errors caused by conductive media sticking to the probe rod (e.g. yoghurt). This corresponds to buildup compensation.

Proceed as follows to chose between media forming buildup (e.g. yoghurt) and media not forming buildup (e.g. water):

- Turn the function switch to position **4**
- "Buildup" operating mode
 - => Press the + key for media that tend to form buildup.
 - => The green LED confirms your entry by flashing three times.
- "No buildup" operating mode
 - => Press the – key for media that do not form buildup.
 - => The green LED confirms your entry by flashing three times.

6.2.3 Function switch - position 2 Carry out empty calibration (for empty tanks)

If the tank is empty (0 %), the empty calibration sets the signal current to the lower value of 4 mA. When empty calibration is completed, the current value of 4 mA is displayed at the ammeter.

Proceed as follows to perform empty calibration:

- Turn the function switch to position **2**
- Press the – and + keys together for approx. 2 s until the green LED flashes*
 - => Release the two keys again.
 - => The flashing stops after approx. 5 s.
 - => Empty calibration is saved.

* SW version 1.00.00 flashes red.

6.2.4 Function switch - position 2 Carry out empty calibration (for almost empty tanks)

If possible, the exact level of the tank should be known and should not be too large (< 30 %). Too high a level reduces the accuracy of the zero point (corresponds to the empty tank). An ammeter must be connected to the current pick-off at the electronic insert.

Let us presume that the level was determined for 15 %. Now the current value that corresponds to the level of 15 % must be determined. The lower current value can be adjusted with the +/- keys. The + key increases the value, the - key reduces the value. The following must also be considered:

1. The lower current value (= empty tank, 0 %) is 4 mA.
2. The upper current value (= full tank, 100 %) is 20 mA.
3. This results in a measuring range of 16 mA for a change from 0 % to 100 %, i.e. 0.16 mA increase in the current for every 1 % increase in the level.
4. For a 15 % level, this is 15 % x 0.16 mA/% which equals 2.4 mA. This must be added to the 4 mA to obtain the current value to be set: 2.4 mA + 4 mA = 6.4 mA.

Proceed as follows to perform empty calibration on a partially filled tank:

- Turn the function switch to position **2**
- The current value can be adjusted with the +/- keys. For this purpose, press the + or - key for at least 2 seconds. You can set the desired current value (> 4 mA) using the multimeter connected.
- The empty calibration is saved when you release the key.

6.2.5 Function switch - position 3 Carry out full calibration (for full tanks)

If the tank is full (100 %), the full calibration sets the signal current to the upper value of 20 mA. When empty calibration is completed, the current value of 20 mA is displayed at the ammeter.

Proceed as follows to perform full calibration:

- Turn the function switch to position **3**
- Press the - and + keys together for approx. 2 s until the green LED flashes*
=> Release the two keys again.
=> The flashing stops after approx. 10 s.
=> Full calibration is saved.

* SW version 1.00.00 flashes red.

6.2.6 Function switch - position 3 Carry out full calibration (for almost full tanks)

If possible, the exact level of the tank should be known and should be as large as possible (> 70 %). Too low a level reduces the accuracy of the upper point (corresponds to the full tank). An ammeter must be connected to the current pick-off at the electronic insert.

Let us presume that the level was determined for 90 %. Now the current value that corresponds to the level of 90 % must be determined. The upper current value can be adjusted with the +/- keys. The + key increases the value, the - key reduces the value.

The following must also be considered:

1. The lower current value (= empty tank, 0 %) is 4 mA.
2. The upper current value (= full tank, 100 %) is 20 mA.
3. This results in a measuring range of 16 mA for a change from 0 % to 100 %, i.e. 0.16 mA increase in the current for every 1 % increase in the level.
4. For a 90 % level, this is 90 % x 0.16 mA/% which equals 14.4 mA. This must be added to the 4 mA to obtain the current value to be set: 14.4 mA + 4 mA = 18.4 mA. (You can also take the upper current value and then subtract 10 % x 0.16 mA/% = 1.6 mA from 20 mA.)

Proceed as follows to perform full calibration on a partially filled tank:

- Turn the function switch to position **3**

- The current value can be adjusted with the +/- keys. For this purpose, press the + or – key for at least 2 seconds. You can set the desired current value (< 20 mA) using the multimeter connected.
- The full calibration is saved when you release the key.

6.2.7 Function switch - position 5 Measuring range

At the factory, the measuring range is always calibrated to the probe length ordered. If the electronic insert is used in another probe, the measuring range must be configured in accordance with the probe length.

Proceed as follows to configure the measuring range 2000 pF (probe length < 6 m) or 4000 pF (probe length > 6 m):

- Turn the function switch to position **5**
- Press the – key to set 2000 pF
=> The green LED confirms your entry by flashing three times.
- Press the + key to set 4000 pF
=> The green LED confirms your entry by flashing three times.

6.2.8 Function switch - position 6 Proof test (self-test)



Note!

- From version FW: V 01.03.00
- Before and after the automatic proof test, it is essential to check whether the level value displayed corresponds to the actual level value.

When the self-test is activated, the current output is set to 4 mA and follows a ramp function up to 22 mA. This test is completed after approx. 40 s.

Proceed as follows to activate the device self-test:

- Turn the function switch to position **6**
- Press the – and + keys together to start the function test
=> The green LED flashes quickly until the error current is reached. The red LED flashes until the test is completed.



Note!

After the self-test, the device automatically returns to the operating mode.

6.2.9 Function switch - position 7 Reset - restore factory settings



Caution!

The reset can affect the measurement as the current values are overwritten by those of the factory calibration (0 % (4 mA) and 100 % (20 mA)).

Proceed as follows to restore the factory settings:

- Disconnect the electronic insert from the power supply
- Turn the function switch to **position 7**
- Press and hold the – and + keys together while the device is being reconnected to the power supply
=> red LED flashes slowly and then starts to flash quickly
- The device reset is complete when the red LED goes out
- Release the – and + keys again

6.2.10 Function switch - position 8 Download/Upload sensor DAT (EEPROM)

Calibration values can be transmitted with this function. A distinction is made between two types:

- The sensor has been replaced and the electronic insert should continue to be used.
- The electronic insert has been replaced but the sensor should continue to be used.

For instances of this nature, the calibration values already set can be transferred from the sensor to the electronic insert or from the electronic insert to the sensor.

Proceed as follows to transfer the calibration values from the electronic insert to the sensor:

Download

- Turn the function switch to position **8**
- Press the – key to start downloading from the electronic insert to the sensor
 - => The green LED flashes for approx. 2 s, thereby confirming your entry.
 - => The device now restarts.

Proceed as follows to transfer the calibration values from the sensor to the electronic insert:

Upload

- Turn the function switch to position **8**
- Press the + key to start uploading from the sensor to the electronic insert
 - => The green LED flashes for approx. 2 s, thereby confirming your entry.
 - => The device now restarts.

6.3 "Basic setup" menu

Commissioning with display and operating module



Note!

This section describes how to commission the Liquicap M by means of the display and operating module. The procedure for commissioning by means of FieldCare or the DXR375 handheld terminal is the same. More detailed information can be found in the Operating Instructions for FieldCare (BA 224F/00) or for DXR375 (is supplied together with the handheld terminal).

6.3.1 Initial commissioning

On first power-up, you are requested to select the language for the display texts. After this selection the measured value is displayed.



Note!

If a reset is performed at the device and if the power supply is switched off and on again, the language of the display texts has to be selected again.

Menu structures: Main menu

The main menu is activated by means of the right Enter key ↵.

The following menu headings appear. These are explained in more detail over the following pages:

- "Basic setup"
- "Safety setting" (→ 58)
- "Linearization" (→ 62)
- "Output" (→ 68)
- "Device properties" (→ 72)



Note!

- Liquicap M devices are calibrated on leaving the factory for media with a conductivity of $\geq 100 \mu\text{S}/\text{cm}$ (e.g. for all water-based liquids, acids, alkalis ...). A recalibration is only necessary if the 0 %-value or the 100 %-value should be adjusted to suit customer-specific requirements, the distance to the tank wall is $< 250 \text{ mm}$ or if the liquid is not conductive.

- A distinction is generally made between two types of calibration:

Wet calibration:

During wet calibration ("Wet" operating mode), the probe must be covered by liquid in the installed state. This calibration can be carried out if the tank is empty, full or partially full. Empty and full calibration must be performed.



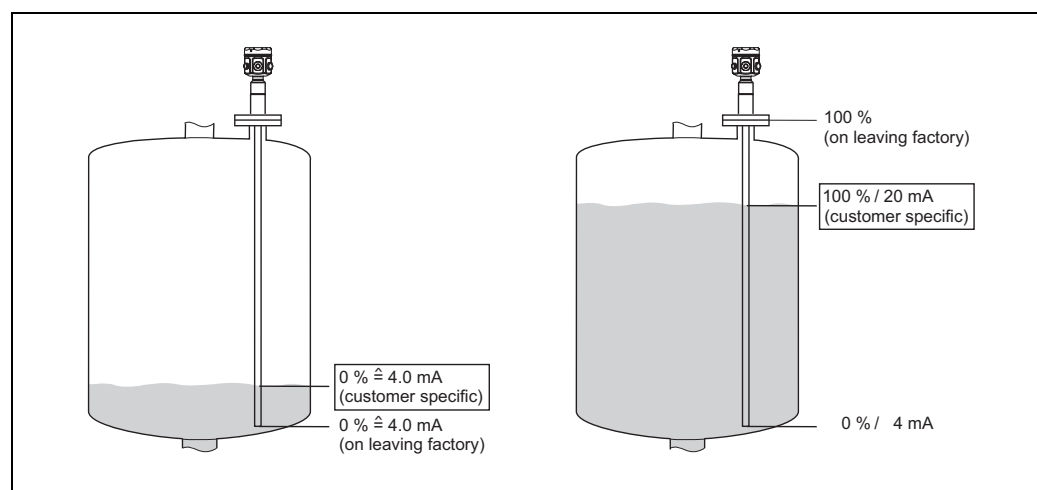

- **Dry calibration**

During dry calibration, empty and full calibration can be carried out without the probe being in contact with the liquid. The calibration values can be entered directly in units of length (e.g. mm, ...) for example.



L00-FMI5xxxx-15-05-zz-en-000

You can make the following settings in the "Basic setup" menu:

Menu	Function	Subfunction	Function value	
	 	 		
Basic setup	Basic setup	Medium property	no buildup ¹⁾ buildup	
		Cal. type	Dry Wet	
		Medium property ²⁾	Conductive Nonconductive ³⁾ interface unknown	
			DC value ⁴⁾	Value
			Unit level ⁵⁾	% (percentage) m mm ft inch
	Empty calibr.	Value empty Measure capacity Confirm cal.:	0 % xxxx pF Yes	
	Full calibr.	Value full Measure capacity Confirm cal.:	100 % xxxx pF Yes	
	Output damping	Output damping	1 s	

- 1) Factory settings are marked in "bold".
- 2) This function is only displayed if the function value "Dry" was selected under the subfunction "Cal. type".
- 3) This function value can only be selected for probes with a ground tube.
- 4) This subfunction is only displayed if the function value "Nonconductive" was selected under the subfunction "Medium property".
- 5) This subfunction is only displayed if the function value "Nonconductive" or "Conductive" was selected under the subfunction "Medium property".

6.3.2 "Basic setup" function

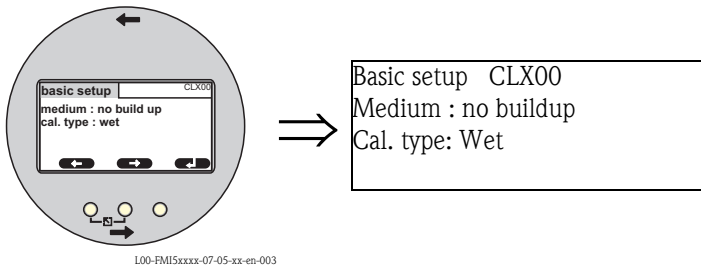

"Medium property" subfunction

The **"No buildup"** operating mode should be set for media that do not tend to form buildup on the probe rod (e.g. water, beverages etc.). As of a conductivity of 100 $\mu\text{S}/\text{cm}$ (i.e. all water-based liquids, acids, alkalis ...), the measured value is independent of the conductivity of the liquid (independent of concentration fluctuations).

In the **"Buildup"** operating mode, the buildup compensation function integrated in the software is activated. In this operating mode, the measured value is independent of the conductivity of the liquid as of a conductivity of 1000 $\mu\text{S}/\text{cm}$ (independent of concentration fluctuations).

This compensates measuring errors caused by conductive media sticking to the probe rod (e.g. yoghurt). This corresponds to buildup compensation.

"Cal. type" subfunction

In the **"Dry"** "Cal. type" empty and full calibration can be carried out without the probe being in contact with the liquid. The calibration values can be entered directly in units of length (e.g. m, mm, ...) for example.

In the **"Wet"** **"Cal. Type"**, the probe must be covered by liquid in the installed state for full calibration. This calibration can also be carried out if the tank is partially full. Both the empty calibration and full calibration must be performed.

6.3.3 "Medium property" function



Note!

This function is only displayed if the function value "Dry" was selected under the subfunction "Cal. type".

"Medium property" subfunction

The properties of the medium are entered here.

- **"Nonconductive"**: the conductivity of the medium is $\leq 1 \mu\text{S}/\text{cm}$ (only with ground tube)
- **"Conductive"**: the conductivity of the medium is $\geq 100 \mu\text{S}/\text{cm}$
- **"Interface"**: the properties of the two media can be entered in the operating program of ToF Tool. The associated calibration values are then calculated.
- **"Unknown"**: the medium properties are not known. The capacitance values of the "Empty calibr." and "Full calibr." functions can be entered directly.

"DC value" subfunction



Note!

This subfunction is only displayed if the function value "Nonconductive" was selected under the subfunction "Medium property".

The dielectric constant for the liquid to be measured is entered here (e.g. 3.4)

"Unit level" subfunction

Note!

This subfunction is only displayed if the function value "Conductive" or "Nonconductive" was selected under "Medium property".

The desired level unit for Basic setup is entered here.

6.3.4 "Empty calibr." function ("Wet" operating mode)

Note!

The calibration data can be calculated with **CapCalc.xls** → 78.

With "Empty calibration", the 0 % value or the 4 mA value is assigned to the level value.



Note!

The procedure applies to the "Wet" type of calibration. Information on "Dry" calibration is provided further below.

"Value empty" subfunction

The current level value is entered here,
e.g. 5 % partial filling => "Value empty" 5 % or
e.g. 0 % partial filling => "Value empty" 0 %



Note!

To keep the calibration error to a minimum, the level should be between 0 % and 30 %.

"Measure capacity" subfunction

The capacitance value currently measured is displayed here.

"Confirm cal." subfunction

In this function, empty calibration is confirmed and the "Measure capacity" currently measured is assigned to the percentage level value entered above ("Value empty").

6.3.5 "Full calibr." function ("Wet" operating mode)

With "Full calibration", the 100 % value or the 20 mA value is assigned to the level value.



Note!

The procedure applies to the "Wet" type of calibration. Information on "Dry" calibration is provided further below.

"Value full" subfunction

The current level value is entered here,
e.g. 90 % partial filling => "Value full" 90 % or
e.g. 100 % filling => "Value full" 100 %



Note!

To keep the calibration error to a minimum, the level should be between 70 % and 100 %.

"Measure capacity" subfunction

The capacitance value currently measured is displayed here.

"Confirm cal." subfunction

Full calibration must be confirmed with this function.

6.3.6 "Empty calibr." function ("Dry" operating mode)

The "Empty" value can be entered directly in units of length if the medium property has been set to conductive or nonconductive.

"Value empty" subfunction, medium property (conductive, nonconductive)

In this function, specify the distance E, i.e. the distance from the active probe rod to the desired zero point.

Value E:
 Empty calibration \leq active probe length
 $E \leq L1 - (\text{thread length } H4 + \text{plug})$

Thread length:
 H4 for G1½ = 25 mm
 H4 for G < 1½ = 19 mm

Plug:
 10 mm rod = 10 mm
 16 mm rod = 15 mm
 22 mm rod = 15 mm

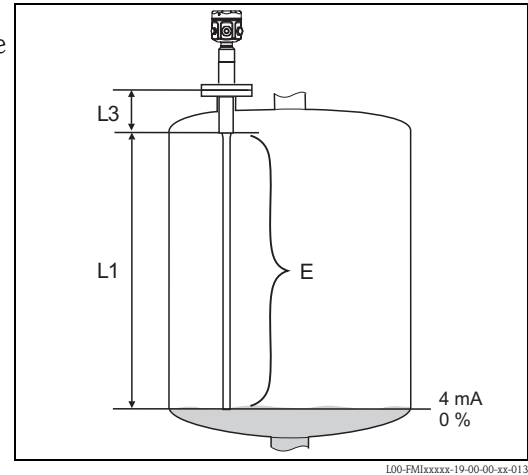

"Cap. empty" subfunction

The calculated capacitance value is displayed here. This field cannot be edited.

"Confirm cal." subfunction

Empty calibration is confirmed with this subfunction.

6.3.7 "Full calibration" function ("Dry" operating mode) for conductive and nonconductive media

The "Full" value can be entered directly in units of length.

"Value full" subfunction, medium property (conductive, nonconductive)

In this function, specify the span F, i.e. the distance from the zero point to the desired 100% point.

"Value full"
 $F \leq E$ "Value empty" (→ 56)

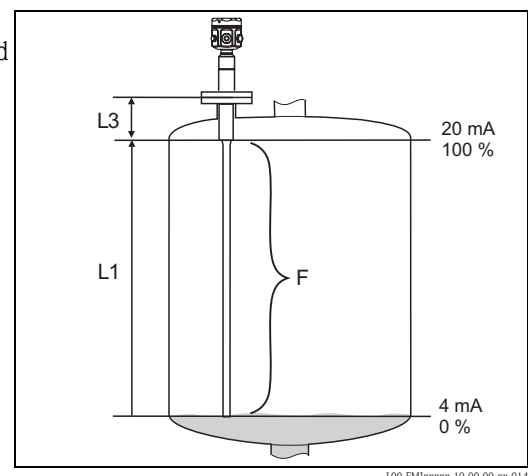

"Cap. full" subfunction

The calculated capacitance value is displayed here. This field cannot be edited.

"Confirm cal." subfunction

Full calibration is confirmed with this subfunction.

6.3.8 "Empty calibration" function ("Dry" operating mode for "Interface" or "Unknown" medium properties)**"Value empty" subfunction**

This field displays 0 % and cannot be edited.

"Cap. empty" subfunction

Enter the capacitance value calculated with CapCalc.xls, for example, (capacitance calculation program in FieldCare) here.

"Confirm cal." subfunction

Empty calibration must be confirmed with this subfunction.

6.3.9 "Full calibration" function ("Dry" operating mode for "Interface" or "Unknown" medium properties)**"Value full" subfunction**

This field displays 100 % and cannot be edited.

"Cap. full" subfunction

The capacitance value calculated with CapCalc.xls, for example, (capacitance calculation program in FieldCare) is entered here.

"Confirm cal." subfunction

Full calibration must be confirmed with this subfunction.

6.3.10 "Output damping" function

With this function, you can set the reaction time of your measuring device to changes in the level. If surfaces are turbulent, a higher output damping (e.g. 2 s) should be selected.

6.4 "Safety setting" menu

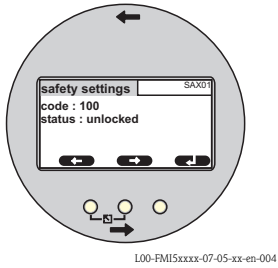

Safety settings SAX01
Code: 100
Status: unlocked

You can make the following settings in the "Safety settings" menu.

Menu	Function	Subfunction	Function value
	← →	↓ ↑	
Safety settings	Safety settings	Code	100 ¹⁾
		Status	Unlocked Locked
Safety settings	Safety settings	Operating mode	Standard SIL/WHG
		Output damping	1 s
		Output 1	MAX
		Parameter okay	no Yes
		Safety settings	Cap. empty
	Value empty	x,xxx %	
	Cap. full	2000.00 pF	
	Value full	100.000 %	
	Parameter okay	no Yes	
Operating mode	Operating mode	Operating mode	Standard SIL/WHG
		SIL op. mode ²⁾	Unlocked Locked
		Status	Unlocked Locked
Output on alarm	Output		Max Hold User-spec.
		Output value ³⁾	xx.xx mA
Proof test	Proof test		Off On

- 1) Factory settings are marked in "bold".
- 2) This subfunction is only displayed if the "SIL/WHG" option was selected under the "Operating mode" subfunction.
- 3) This subfunction is only displayed if the "User-specific" option was selected under the "Output" subfunction.

6.4.1 "Safety settings" function

"Code" subfunction

With this subfunction, you can lock the device against unpermitted or unintentional changes.

- Enter a number \neq 100 to lock the device. Parameters can then no longer be modified.
- Enter "100" to unlock the device. Parameters can then be modified again.

"Status" subfunction

This subfunction displays the current locking status of the device. The following values can appear:

- **"Unlocked"**

All writeable parameters can be modified.

- **"Locked"**

The device has been locked via the operating menu ("Code" subfunction). It can only be unlocked by entering "100" in the "Code" subfunction.

6.4.2 "Safety settings" function**"Operating mode" subfunction**

This subfunction displays the set operating mode and cannot be edited.

Possible operating modes:

- Standard
- SIL/WHG

"Output damping" subfunction

This subfunction displays the output damping set. Output damping is the time at which the measuring system reacts to changes in level and is between 0 and 60 seconds.

"Output 1" subfunction

This subfunction displays the set value the output assumes in an alarm condition. Possible values are:

- MAX (22 mA)
- Hold (the last value is held)
- User-spec.

"Parameter okay" subfunction

With this subfunction, you confirm that the parameter values displayed under the "Safety settings II" function are correct.



Note!

The "Parameter okay" subfunction has to be confirmed with "Yes" so the device can be locked for the SIL/WHG operating mode. In addition, the SIL/WHG function value has to be selected for the "Operating mode" subfunction and "Locked" must be set for the "Status" subfunction. The device can be unlocked using the special release code. The release code is "7452".

6.4.3 "Safety settings" function**"Cap. empty" subfunction**

This subfunction displays the measured capacitance during empty calibration in pF.

"Value empty" subfunction

This subfunction displays the empty calibration value in %.

"Cap. full" subfunction

This subfunction displays the measured capacitance during full calibration in pF.

"Value full" subfunction

This subfunction displays the full calibration value in %.

"Parameter okay" subfunction

With this subfunction, you confirm that the parameter values displayed under the "Safety settings II" function are correct.



Note!

The "Parameter okay" subfunction has to be confirmed with "Yes" so the device can be locked for the SIL/WHG operating mode. In addition, the SIL/WHG function value has to be selected for the "Operating mode" subfunction and "Locked" must be set for the "Status" subfunction. The device can be unlocked using the special release code. The release code is "7452".

6.4.4 "Operating mode" function**"Operating mode" subfunction**

With this subfunction, you can switch from the Standard operating mode to the SIL/WHG operating mode:

- **"Standard"**
- **"SIL/WHG"**

The following parameters are set to defined values in the "SIL/WHG" operating mode:

- Output damping: Output damping is fixed at "1 s"
- Output on alarm: The "Output on alarm" function is fixed at "22 mA".

In the "SIL/WHG" operating mode, cyclic self-monitoring of the device takes place (e.g. memory test, processor test, current output ...).

"SIL operating mode" subfunction

You can lock or unlock the device in this subfunction. No parameters can be changed in the locked state.

"Status" subfunction

This subfunction displays the current locking status of the device. The following values can appear:

- **"Unlocked"**
All writeable parameters can be modified.
- **"Locked"**
The device has been locked via the operating menu ("Code" subfunction). It can only be unlocked by entering "100" in the "Code" subfunction.

6.4.5 "Safety settings" function**"Operating mode" subfunction**

The "Standard" or "SIL/WHG" operating mode entered is displayed here.

"Output damping" subfunction

The output damping entered is displayed here.

"Value empty" subfunction

The capacitance of the empty calibration is displayed here.

"Value full" subfunction

The capacitance of the full calibration is displayed here.

"Parameter okay" subfunction

With this subfunction, you confirm that the parameter values displayed under the "Safety settings II" function are correct.



Note!

The "Parameter okay" subfunction has to be confirmed with "Yes" so the device can be locked for the SIL/WHG operating mode. In addition, the SIL/WHG function value has to be selected for the "Operating mode" subfunction and "Locked" must be set for the "Status" subfunction. The device can be unlocked using the special release code. The release code is "7452".

6.4.6 "Output on alarm" function

"Output" subfunction

This function determines the value the output in question assumes when an alarm condition occurs.

Options:

- **"Max"**
22 mA
- **"Hold"**
The last value is retained
- **"User-spec."**
As defined in the "Output value" subfunction

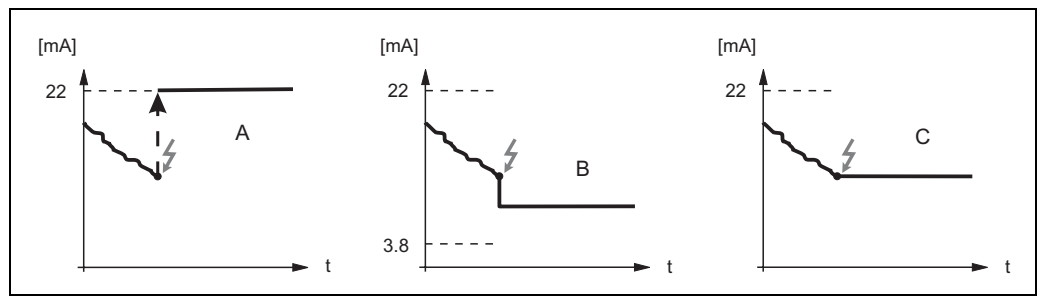

A: Max.; B: User-specific (between 3.8 and 22 mA); C: Hold

L00-FMI5xxxx-19-05-xx-xx-006

"Output value" subfunction (only for "Output", "User-specific")

In this function, specify the user-specific value the current output should assume in an alarm condition.

- Value range: 3.8 to 22 mA

6.4.7 "Proof test" function (self-test)



Note!

- From version FW: V 01.03.00
- Before and after the automatic proof test, it is essential to check whether the level value displayed corresponds to the actual level value.
- After the self-test, the device automatically returns to the operating mode.

"Proof test" subfunction

With this subfunction, you activate the device self-test. All electronic components relevant to the function are tested. In a ramp of approx. 40 s, the current output goes through the range of 4 to 22 mA.

6.5 "Linearization" menu

"Linearization" is used for converting the level to any unit. You can determine the volume or the mass in a tank of any shape. Liquicap M makes various linearization modes available for situations that occur frequently. Furthermore, a linearization table can be entered for tanks and containers of any shape.

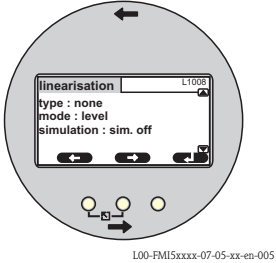

L00-FMI5xxxx-07-05-xx-en-005

```
Linearization L1008
Type: None
Mode: Level
Simulation: Sim. off
```



Note!

The number and type of subfunctions depend on the type of linearization selected.

Only the "Type" and "Mode" subfunctions are always available.

You can make the following settings in the "Linearization" menu:

Menu	Function	Subfunction	Function value	Additional function values
	← →	↓ ↑		
Linearization	Linearization	Type	None Linear ¹⁾ Horizontal cyl ²⁾ Sphere ²⁾ Pyramid bottom ³⁾ Conical bottom ³⁾ Angled bottom ³⁾ Table	
		Mode	level Ullage	
		Simulation	Sim. off Sim. level Sim. volume	
		Sim. level value ⁴⁾ or Sim. vol. value ⁴⁾	xx.x % xx.x %	
	Linearization	Customer unit	% (percentage), l, hl, m3, dm3, cm3, ft3, usgal, igital, kg, t, lb, ton, m3, ft3, mm, inch, user-spec.	
		Customized text ⁵⁾	...	
		Diameter ⁶⁾	xxxx m	
		Intermed. height ⁷⁾	xx m	
		Edit ⁸⁾	Read	Table No.: 1 Input level: x m Input volume: %
			Manual	Table No.: 1 Input level: x m Input volume: %
			Semi-automat.	Table No.: 1 Input level: x m Input volume: %
			Delete	
		Status table ⁷⁾	Enabled Disabled	
		Max. scale ⁹⁾	100 %	

- 1) Factory settings are marked in "bold".
- 2) If you enter a value for this function, you must also enter a value for the "Diameter" subfunction in another step.
- 3) If you enter a value for this function, you must also enter a value for the "Intermed. height" subfunction in another step.
- 4) This function is only displayed if the "Sim. off" option was not selected under the "Simulation" subfunction.
- 5) This function is only displayed if the "User-spec." option was selected under the "Customer unit" subfunction.

- 6) This function is only displayed if the "Horizontal cyl" or "Sphere" option was selected under the "Type" subfunction.
- 7) This function is only displayed if the "Pyramid bottom", "Conical bottom" or "Angled bottom" option was selected under the "Type" subfunction.
- 8) This function is only displayed if the "Table" option was selected under the "Type" subfunction.
- 9) This function is not displayed if the "Table" option was selected under the "Type" subfunction.

6.5.1 "Linearization" function

"Type" subfunction

Select the type of linearization in this subfunction.

Options:

- "None"

In this type of linearization, the measured level is not converted but instead is output linearly in the level unit selected (see "Unit level" function).

- "Linear"

In this type of linearization, the measured value output is linear to the measured level.

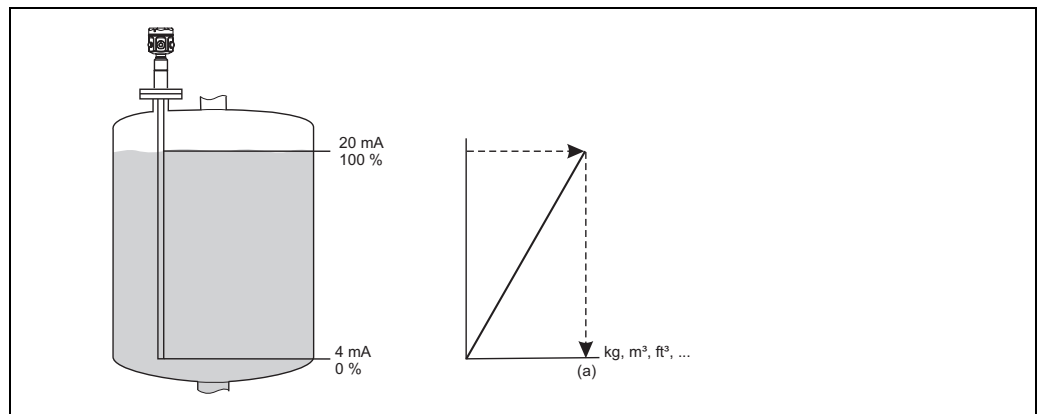

100-FMI5xxxx-19-05-xx-xx-001

The following must be specified as additional parameters:

- The unit for the linearized value, e.g. kg, m³, ft³, ... ("**Customer unit**" subfunction)
- The maximum tank contents (a) measured in a customer unit ("**Max. tank contents**" subfunction)

Options:

- "Horizontal cyl."
- "Sphere"

In these types of linearization, the volume in a spherical tank or in a horizontal cylindrical tank is calculated from the level.

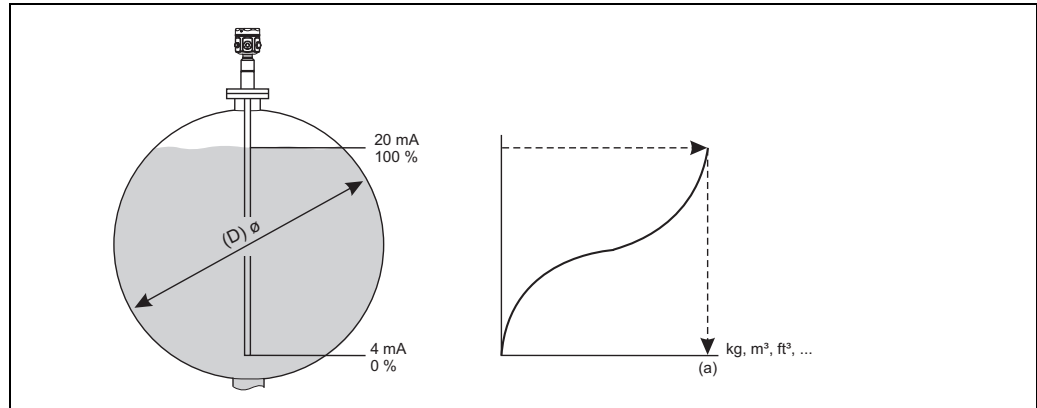

L00-FMI5xxxx-19-05-xx-xx-002

The following must be specified as additional parameters:

- The unit for the linearized value, e.g. kg, m³, ft³, ... ("**Customer unit**" subfunction)
- The diameter (D) of the cylindrical or spherical tank ("**Diameter**" subfunction)
- The maximum tank contents (a) measured in a customer unit ("**Max. tank contents**" subfunction)

Options:

- "Pyramid bottom"
- "Conical bottom"
- "Angled bottom"

In these types of linearization, the volume in the tank in question is calculated from the level measured.

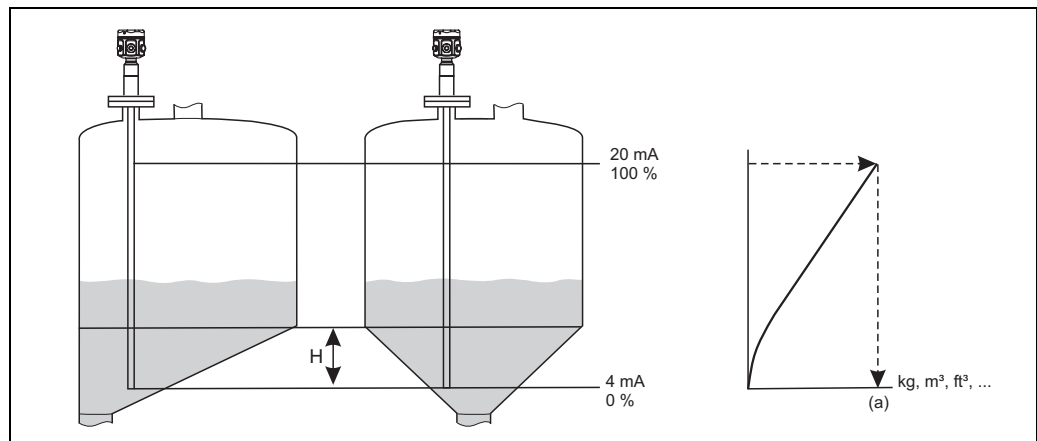

L00-FMI5xxxx-19-05-xx-xx-003

The following must be specified as additional parameters:

- The unit for the linearized value, e.g. kg, m³, ft³, ... ("**Customer unit**" subfunction)
- The intermediate height H in accordance with the diagram above ("**Intermed. height**" subfunction)
- The maximum tank contents (a) measured in a customer unit ("**Max. tank contents**" subfunction)

Options:■ **"Table"**

In this type of linearization, the measured value is calculated using a linearization table. The table can comprise up to 32 "Level - Volume" value pairs. The table must be monotone.

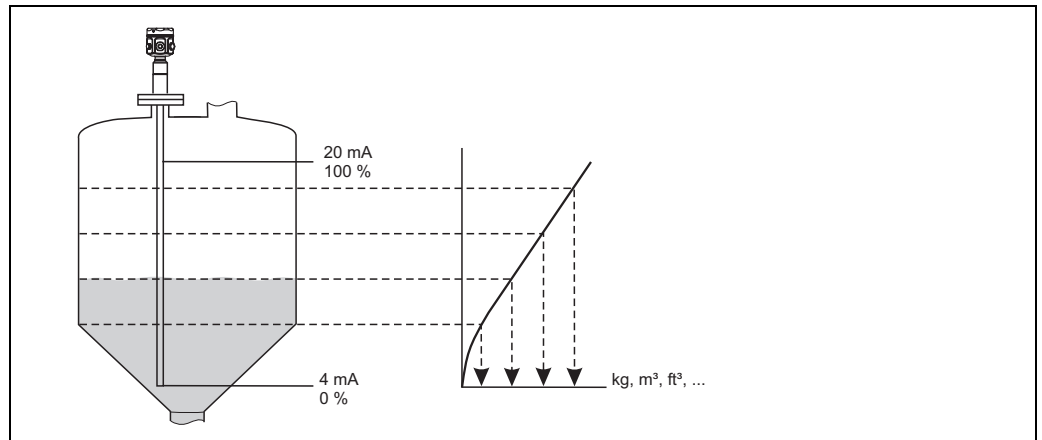

The following must be specified as additional parameters:

- The unit for the linearized value ("**Customer unit**" subfunction)
- The **linearization table** ("**Edit**" subfunction)

"Mode" subfunction

In this function, specify whether the measurement should refer to level A or to the empty area B.

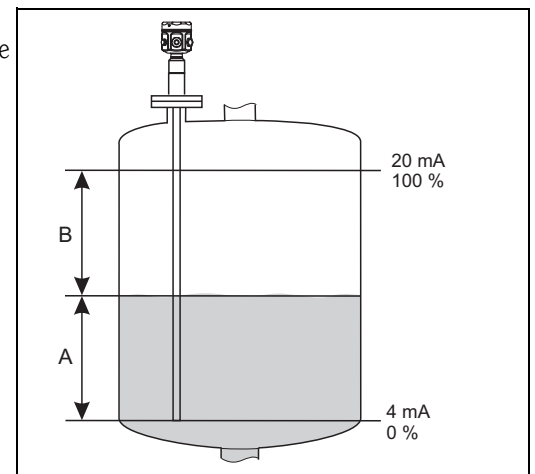
**"Simulation" subfunction**

In this subfunction, you can simulate the level or the volume by entering a level under "Sim. level value" or a volume under "Sim. vol. value".

"Sim. level value" or "Sim. vol. value" subfunction

In this subfunction, you can enter the level or volume value to be simulated.

6.5.2 "Linearization" function**"Customer unit" subfunction**

In this function, enter the desired unit for the linearized values (e.g. kg, m³, ft³, ...).

"Customized text" subfunction

In this function, enter your specific name for the unit. The measured value indicated in the main screen will then be displayed in this unit.

"Diameter" subfunction

In this subfunction, specify the diameter of the horizontal cylindrical tank or the spherical tank (only for the "dry" type of basic setup).

"Intermed. height" subfunction

In this function, specify the intermediate height H (see graphic -> options: "Pyramid bottom", "Conical bottom", "Angled bottom") of the container in question.

The probe length L1 must be entered here in the event of a wet calibration.

"Edit" subfunction

Use this function to enter, modify or read the linearization table.

The following options are available:

- **"Read"**
The table editor is opened. The existing table can be read but not edited.
- **"Manual"**
The table editor is opened. Table values can be entered or modified.
- **"Semi-automat."**
The table editor is opened. The level value is read in automatically.
The related measured value (volume, weight or flow) must be entered by the user.
- **"Delete"**
The linearization table is deleted.



Note!

The linearization table can only be edited if it is disabled ("Status" subfunction)

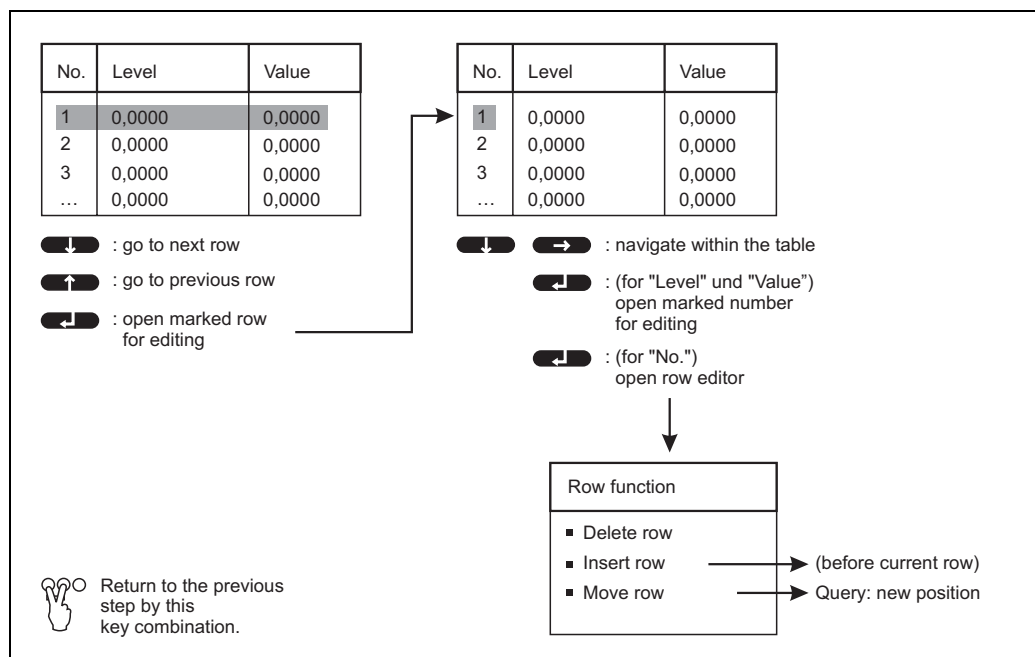
The table editor

L00-FMI5xxxx-19-05-zz-en-013

"Status table" subfunction

In this function, you can specify whether the linearization table should be used or not.

Options:■ **"Enabled"**

The table is used.

■ **"Disabled"**

The table is not used. The measured value is output linearly with regard to the level unit.

"Max. scale" subfunction



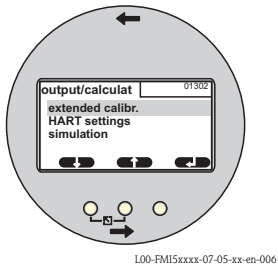

In this function, specify the maximum contents of the tank in question in the customer unit.

6.6 "Output" menu



Output/calculat.	O1302
extended calibr.	
HART setting	
Simulation	

You can make the following settings in the "Output" menu:

Menu	Submenu	Function	Subfunction	Function value	
	 	 			
Output	Extended calibr.	Extended calibr.	Measuring range	2000 pF¹⁾ 4000 pF	
			Sensor DAT Stat.	OK	
			Sensor DAT	Upload Download	
			Output/Calculat	Curr. turn down	On Off
				Turn down 4 mA ²⁾	0 %
				Turn down 20 mA ²⁾	100 %
				4 mA threshold	On Off
	HART setting	HART setting	HART address	0	
			No. of preambles	5	
			Short TAG HART	TAG	
	Simulation	Simulation	Output/Calculat	Current span	4 to 20 mA Fix. curr. HART
				mA value ³⁾	4 mA
			Simulation value ⁴⁾	On Off xx.xx mA	

- 1) Factory settings are marked in "bold".
- 2) This function is only displayed if the "On" option was selected under the "Curr. turn down" subfunction.
- 3) This function is only displayed if the function value "Fix. curr. HART" was selected under the "Current span" subfunction.
- 4) This function is only displayed if the "On" option was selected under the "Simulation" function.

6.6.1 "Extended calibr." submenu

"Extended calibr." function

In this function, you can specify the measuring range.

"Measuring range" subfunction

Specify the measuring range in this subfunction.

- $C_A = 0$ to 2000 pF (< 6 m probe length)
- $C_A = 0$ to 4000 pF (> 6 m probe length)



Note!

At the factory, the measuring range is always calibrated to the probe length ordered. If the electronic insert is used in another probe, the measuring range must be configured in accordance with the probe length.

"Output/Calculat." function*"Sensor DAT stat." subfunction*

This subfunction shows the status of the sensor DAT.

- OK (Sensor DAT is ready for use).
- Error (Sensor DAT is not ready for use ore or missing).

"Sensor DAT" subfunction

Calibration values can be transmitted with this function. A distinction is made between two types:

- The sensor has been replaced and the electronic insert should continue to be used.
- The electronic insert has been replaced but the sensor should continue to be used.

For instances of this nature, the calibration values already set can be transferred from the sensor to the electronic insert or from the electronic insert to the sensor.

Upload

To transfer the calibration values from the sensor to the electronic insert.

Download

To transfer the calibration values from the electronic insert to the sensor.

"Curr. turn down" subfunction

With this function, you can switch on the current turn down. The current output then only refers to a (freely definable) part of the measuring range. This is then magnified when displayed.

"Curr. turn down" subfunction (not available for "Current span", "Fix. curr. HART")

With this function, you can switch on the current turn down. The current output then only refers to a (freely definable) part of the measuring range. This is then magnified when displayed.

"Turn down 4 mA" subfunction (only for "Curr. turn down", "On")

In this function, enter the measured value at which the current should be 4 mA.

"Turn down 20 mA" subfunction (only for "Curr. turn down", "On")

In this function, enter the measured value at which the current should be 20 mA.

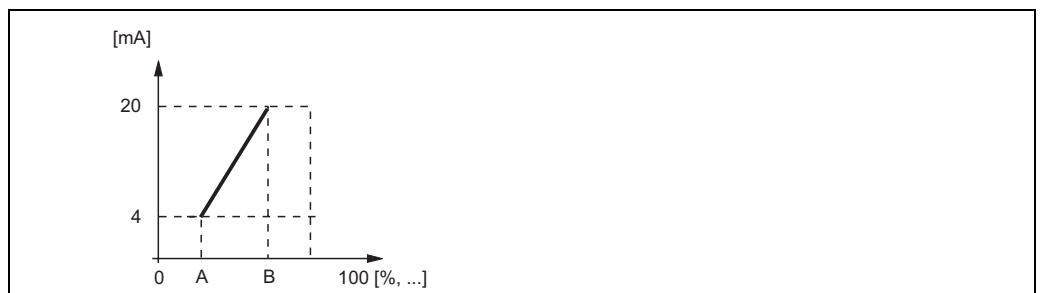

A: Turn down 4 mA; B: turn down 20 mA

100-FMI5xxxx-19-05-xx-xx-009

"4 mA threshold" subfunction (for "Current span" = "4 to 20 mA")

You can switch on the 4 mA threshold in this subfunction. The 4 mA threshold means that the current never undershoots 4 mA even if the measured value is negative.

Options:

■ "Off"

The threshold is switched off. Currents under 4 mA can occur.

■ "On"

The threshold is switched on. The current never undershoots 4 mA.

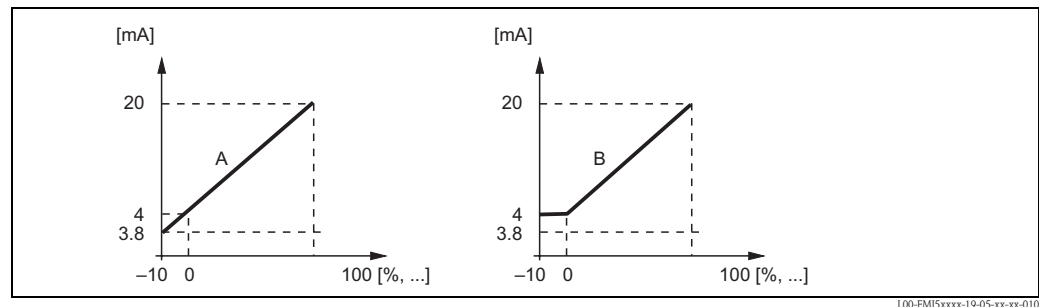

A: 4 mA threshold off; B: 4 mA threshold on

L00-FMI5xxxx-19-05-xx-xx-010

6.6.2 "HART setting" submenu

"HART settings" function

"HART address" subfunction

In this subfunction, specify the HART communication address for the device.

Possible values:

- For standard operation: 0
- For multidrop operation: 1 - 15



Note!

In multidrop operation, the output current is 4 mA as standard. However, it can be changed in the "mA value" function.

"No. of preambles" subfunction

In this subfunction, specify the number of preambles for the HART protocol. It might make sense to increase the value if there are communication problems on the lines.

"Short TAG HART" subfunction

Here, you can enter the TAG name for HART communication in the device.

Output/Calculat" function."

"Current span" subfunction

In this subfunction, select the current span to which the measuring range should be mapped.

Options:

■ "4 to 20 mA"

The measuring range (0 % to 100 %) is mapped to the 4 to 20 mA current span.

■ "Fix. curr. HART"

A fixed current is output. Its value can be specified in the "mA value" subfunction. The measured value is only transmitted via the HART signal.

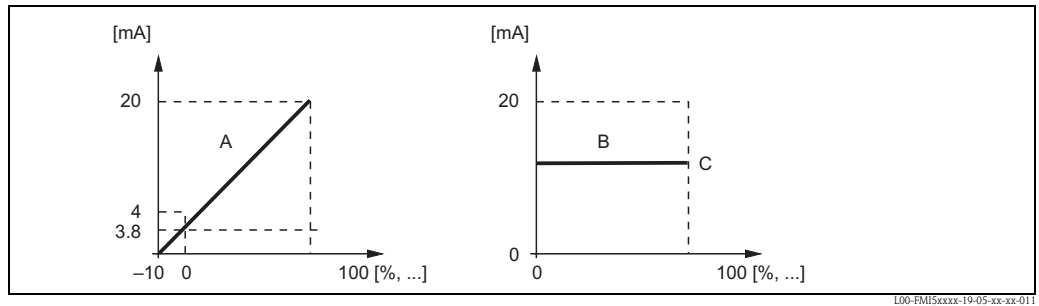

A: Current span = 4 to 20 mA; B: current span = fix. curr. HART; C: mA value

6.6.3 "Simulation" submenu

"Simulation" function

"Simulation" subfunction

With this function, you can switch the simulation of an output current on and off.

Options:

- "Off"

Simulation does not take place. Instead, the device is in the measuring mode.

- "On"





The device is in the simulation mode. A measured value is not output. Instead, the current output assumes the value defined in the "Simulation value" subfunction.

"Simulation value" subfunction (only for "Simulation", "On")

Specify the current value to be simulated in this function.

6.7 "Device properties" menu

You can make the following settings in the "Device properties" menu:

Menu	Submenu	Function	Subfunction	Function value
	 	 		
Device properties	Display	Language		English Deutsch Francais Espanol Italiano Nederlands
		Display format	Format	Decimal ft-in-1/16"
			No of decimals	x x.x x.xx x.xxx
			Sep. character	. (dot) ,
			Back to home	900 s
	Diagnostics	Actual error	Actual error 1 Actual error 2 Actual error 3
		Last error	reset errorlist Last error 2 Last error 3	Keep Delete
		Password/reset	Reset Status	12345 Unlocked
		Electronic temp.	Electronic temp. Max. temp. Min. temp. Temperature unit Min/Max temp.	xx.x °C xx.x °C xx.x °C °C °F K Keep Delete Reset Min. Reset Max.
		Measure capacity	Measure capacity Max. capacity val Min. capacity val Min/Max capacity	xxxx.xx pF xxxx.xx pF xxxx.xx pF Keep Delete Reset Min. Reset Max.
	System parameters	Device information	Device designation Serial No. EC Serial No. Device marking	Liquicap-FMI5x ... xxxxxxxxxxxx FMI51-OrderCode
		Device information	Dev. rev Software version DD version	x V01.xx.xx.xxx xx
		Device information	Working hour Current run time	xxxxx h 000d00h00m
		Probe length	Probe length Sensitivity	xxx mm 0.0

6.7.1 "Display" submenu

"Language" function

In this function, select the language for the display and operating module.

Options:

- "English"
- "Deutsch"
- "Français"
- "Español"
- "Italiano"
- "Nederlands"

"Display format" function

The "Display format" refers to how the measured value is displayed.

"Format" subfunction

In this subfunction, select the display format for displaying numbers.

Options:

- "Decimal"
- "ft-in-1/16"

"No. of decimals" subfunction

In this subfunction, select the number of places after the decimal point for displaying numbers.

Options:

- "x"
- "x.x"
- "x.xx"
- "x.xxx"

"Sep. character" subfunction

In this function, select the separator for displaying decimal numbers.

Options:

- "Dot (.)"
- "Comma (,)"

6.7.2 "Diagnosis" submenu

"Actual error" function

With this function, you can call up a list of the errors currently pending. The errors are arranged by priority. If you select an error, a text field appears with a brief description of the error (e.g. probe incorrectly calibrated, operating temperature too high, electronics error), (see also "Error code list" in Section 9, "Troubleshooting").

"Last error" function

With this function, you can call up a list of the errors last rectified. You also have the option of resetting the error list (with "reset errorlist"). This overwrites the last three error codes with 0.

"Password/reset" function

With this function, you can restore the factory settings. All parameters are reset to their factory setting.

"Reset" subfunction

In this subfunction, enter the reset code ("333" or "7864") to reset all the parameters to their factory setting.

- The factory settings of the parameters are marked in bold in the menu overview.
- During a "333" reset, linearization is reset to "linear". However, any linearization table available is retained and can be activated again where necessary.
The following subfunctions (marked with an asterisk (*)) are also reset.
- During a "7864" reset, linearization is reset to "linear" and the linearization table deleted.

"Electronic temp." function

In this function, you can have temperatures displayed that were measured by the electronic insert during operation.

*"Electronic temp." subfunction **

This subfunction displays the electronics temperature currently measured.

*"Max. temp." subfunction **

This subfunction displays the highest temperature value measured by the device.

"Min. temp." subfunction

This subfunction displays the lowest temperature value measured by the device.

"Temperature unit" subfunction

In this subfunction, you can determine the unit in which the temperature should be displayed. The following options are available:

- "°C"
- "°F"
- " K"

"Min/Max temp." subfunction

In this subfunction, you delete or individually reset the "Min. or Max. temp".

"Measure capacity" function

In this function, you can have measuring capacities displayed that were measured by the electronic insert during operation.

"Measure capacity" subfunction

This subfunction displays the measuring capacity currently measured.

*"Max. capacity val." subfunction **

This subfunction displays the highest capacitance value measured by the device.

*"Min. capacity val." subfunction **

This subfunction displays the lowest capacitance value measured by the device.

"Min/Max capacity" subfunction

In this subfunction, you delete or individually reset the "Min. or Max. capacity".

6.7.3 "System parameters" submenu



Note!

All functions listed below can be viewed only.

"Device information" (I) function

In this function, device information, with which the device can be identified, can be displayed.

"Device marking" subfunction

This subfunction displays the device name (e.g. Liquicap M-FMI51).

"Serial No." subfunction

This subfunction displays the serial number of the device that was assigned in the factory.

"EC Serial No." subfunction

This subfunction displays the serial number of the electronic insert.

"Device marking" subfunction

This subfunction displays the device marking and the order code.

"Dev. rev" subfunction

This subfunction displays the version of the electronic-hardware.

"Software version" subfunction

This subfunction displays the software version of the device that was assigned in the factory.

"DD version" subfunction

This function indicates the DD version with which this device can be operated using FieldCare.

"Working hour" subfunction

This subfunction displays the number of operating hours.

"Current run time" subfunction

This subfunction displays the "current run time" of the device. The first three digits display the number of days, followed by "d". The next two digits display the hours, followed by "h". The last two digits indicate the minutes.

"Probe length" function

In this function, more probe information can be displayed.

"Probe length" subfunction

You can read off the current probe length in this subfunction.

Probe length = L1 – (thread length – plug)

See also "Empty calibration" → 56.

"Sensitivity" subfunction

You can read off the current sensitivity in mm/pF in this subfunction.

6.8 Operation

After Basic setup, Liquicap M outputs the measured value via

- the display and operating module
- the current output
(the entire measuring range (0 % to 100 %) is then mapped to the range (4 to 20 mA) of the current output.
- the digital HART signal.

6.9 FieldCare: operating program from Endress+Hauser

The FieldCare operating program is Endress+Hauser's plant asset management tool based on FDT technology. You can use FieldCare to configure all Endress+Hauser devices as well as third-party devices which support the FDT standard. The following operating systems are supported: Windows 2000, Windows XP and Windows Vista.

FieldCare supports the following functions:

- Configuration of transmitters in online operation
- Tank linearization
- Loading and saving device data (upload/download)
- Documentation of the measuring point

Connection options:

HART via Commubox FXA195 and the USB port of a computer



Note!

After reinstalling FieldCare, or by clicking a link in the Help menu, a video can be activated that explains the possible applications of the program in just a few minutes.



[Getting Started \(Help\)](#)

- Create or Update DTM Catalog
- Connect to Devices
 - HART FSK Modem (FXA191, FXA195)
 - FieldGate FXA720 (PROFIBUS)
 - FieldGate FXA520 (HART)

[Getting Started \(Video\)](#)

- FieldCare in a few minutes

[Continue](#)

- Show start-up screen

6.9.1

Menu-guided commissioning:

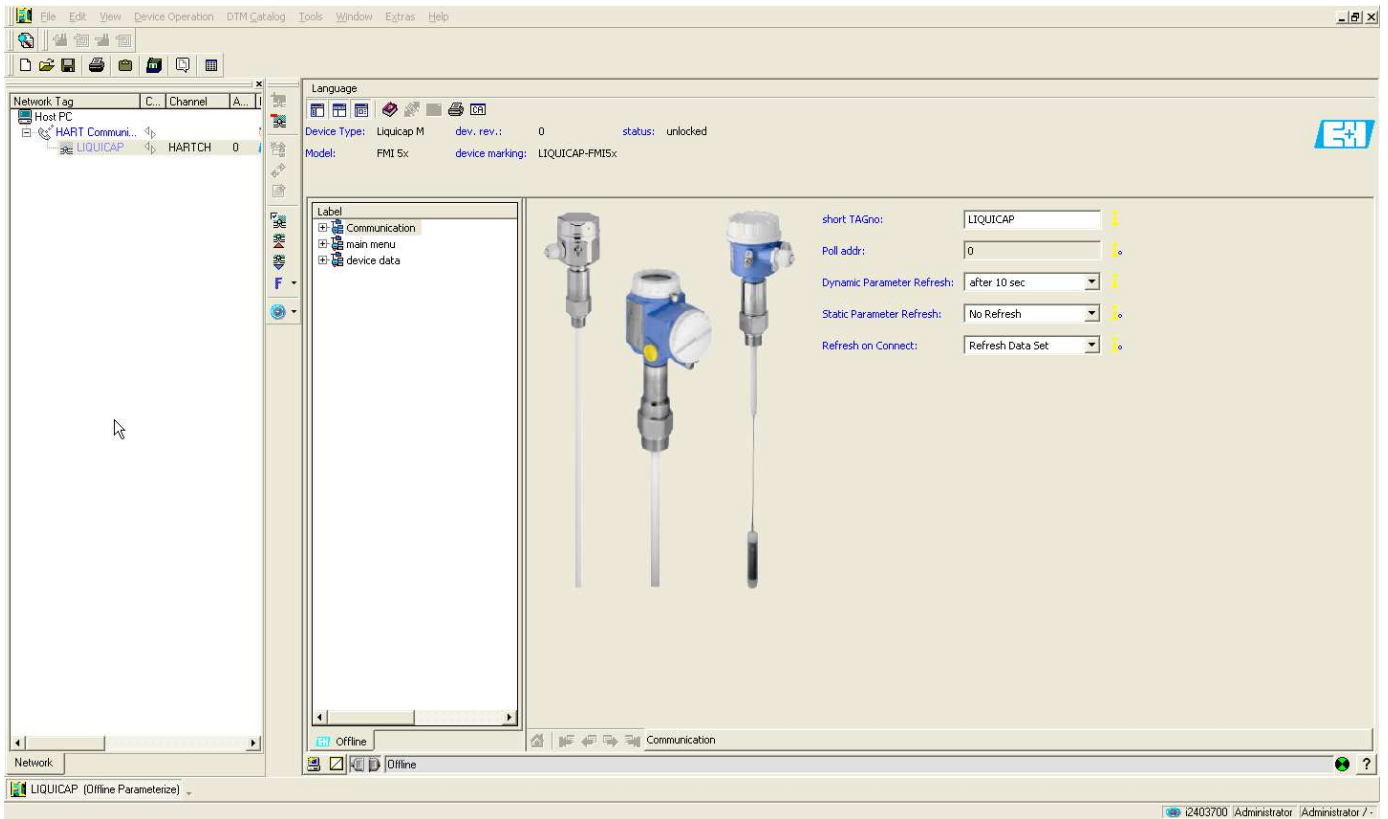

Basic setup:

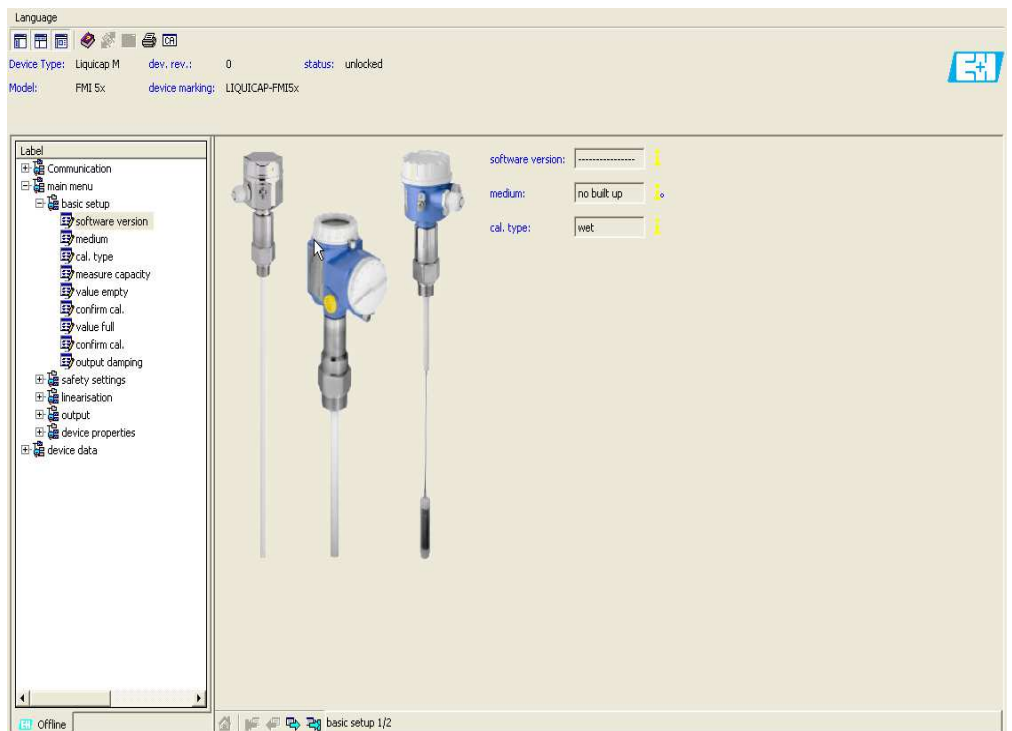

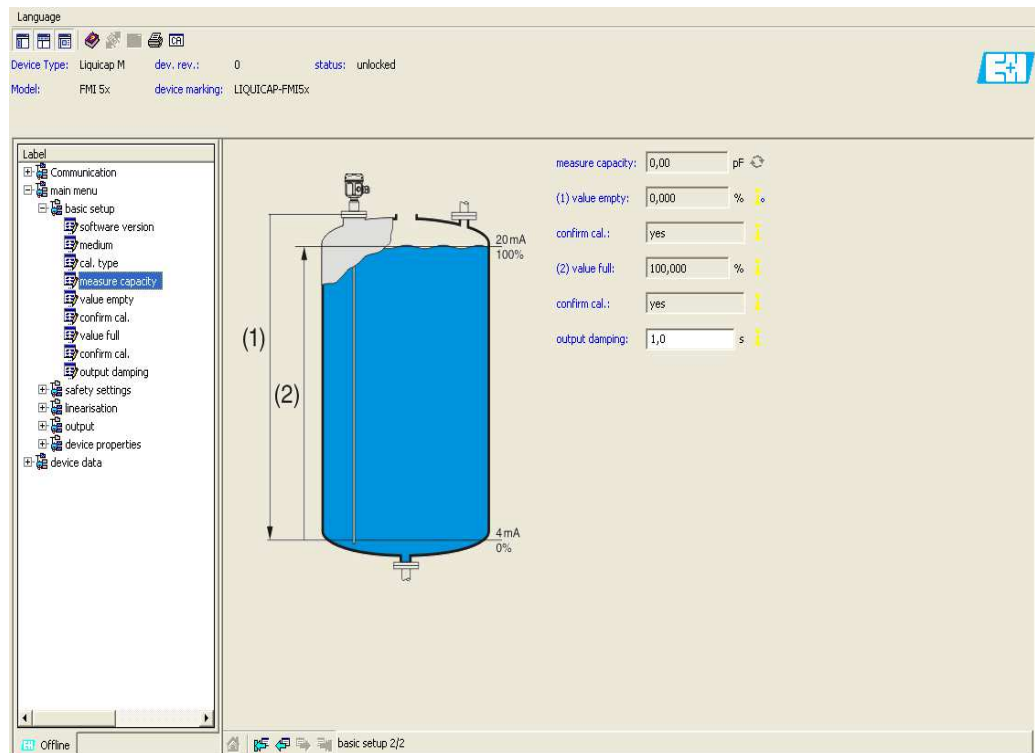

6.9.2 Interface measurement

If there are different media in the container (e.g. water and oil), the capacitance values for "Empty calibration" and "Full calibration" can be calculated.

CapCalc.xls is a capacitance calculation program in FieldCare which can be used to calculate the calibration values for level measurement and interface measurement.

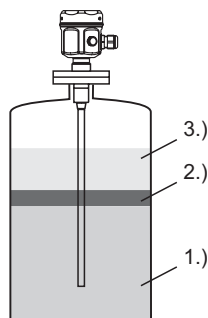

- 1.) e.g. water (the medium must be conductive $\geq 100 \mu\text{S}/\text{cm}$)
 2.) emulsion
 3.) e.g. oil (nonconductive medium $< 1 \mu\text{S}/\text{cm}$ and $DC < 5$)

L00-FMI5xxxx-15-05-xx-xx-000

The program calculates the calibration values on the basis of the data entered (e.g. probe length, probe type, medium properties etc.). The secure functioning of interface measurement can already be determined at this time.

The calculated calibration values can be transmitted to the FEI50H electronic insert via the display or Fieldcare.



Note!

Generally speaking, capacitance interface measurement is also suitable for very pronounced emulsion layers. The emulsion layer average is always measured.

6.9.3 Dry calibration for interface measurement

Calculating the calibration data with CapCalc

Click the CA button in the tool bar to start CapCalc.

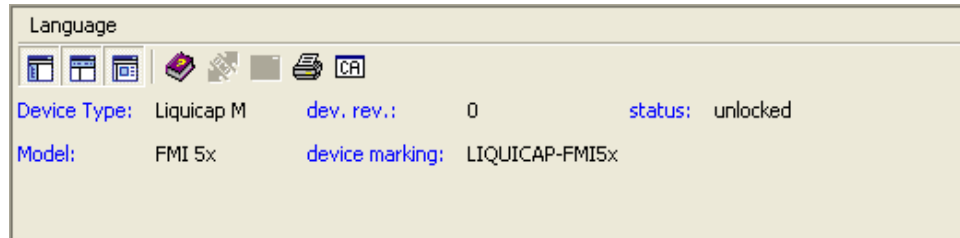

In the dialog that follows, click the "Activate macros" button.



L00-FMIxxxx-20-00-00-en-018

In the window that follows, click the [Next] button in the top right.

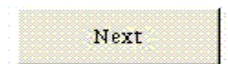

L00-FMIxxxx-20-00-00-en-019

Editing the probe and application-specific data

Endress+Hauser GmbH+Co.KG Hauptstraße 1 79689 Maulburg Germany		Endress+Hauser  People for Process Automation		Sprache wählen Select language
Customer: Muster GmbH+Co.KG		Attention: Hans Mustermann		19.01.2007
Customer-No.:	X0815	Phone:	0815 - 12345	Print
Street:	Musterstraße 5	Fax:	0815 - 6789	
ZIP-Code/Town:	12345 Musterstadt	Reference:	Trennschichtmessung	Info
		Tag:	1122334455	

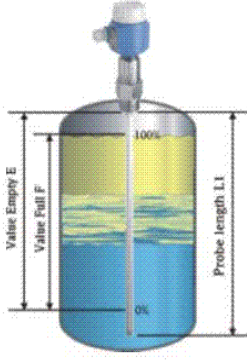
Probe type	FMI51, rod 10mm, PTFE or PFA		Probe type
Probe diameter	8 mm		Auxiliary capacities
Probe diameter with isolation	10 mm		
DC-value of isolation	1,9		
Base capacity	27,67 pF		
Auxiliary capacities	0 pF		
Probe length L1	1000 mm		DC handbook
inactive length L3	0 mm		
Value Empty E	1000 mm		
Value Full F	500 mm		
Wall distance	250 mm		
Medium top			
Name	oil	Calibration data level	
Conductivity	0,01 µS/cm		
Dielectric constant	2,1		
Medium bottom			
Name	water	Calibration data level	
Conductivity	180 µS/cm		
Dielectric constant	80,4		
Calibration data interface measurement			

L00-FMIxxxxx-20-00-00-en-020

1. To select the probe type, click the "Probe type" button.
2. The probe data (L1 and L3) can be found on the nameplate of the probe. Enter these data accordingly.
3. Enter the application-specific data such as "Value empty" and "Value full" and "Wall distance" in accordance with the application.
4. In the "Medium top" and "Medium bottom" fields, enter the conductivity and the DC value of the medium.
5. To obtain the capacitance values for the calibration, click the "Calibration data interface measurement" button. The capacitance values for empty calibration and full calibration are calculated and displayed as a result.

If the medium properties are not known, you can use the "DC handbook" button to transfer the DC values and the conductivity of the corresponding media to the calculation program.

6.9.4 Wet calibration for interface measurement

This chapter describes the wet calibration procedure for "Empty calibration" and "Full calibration".

"Empty calibration"

1. Fill the container with the top medium and perform "Empty calibration" 0 % (see basic setup → [52](#))

If it is not possible to fill with medium, "Empty calibration" can also be performed with the probe exposed (in the air). A calibration inaccuracy of approx. 2.5 % per meter should be expected here (oil and water are the reference media).

"Full calibration"

2. Fill the container with the bottom medium and perform "Full calibration" 100 % (see basic setup → [52](#))

You have now performed basic setup.

6.9.5 Empty and full calibration completed

You have now performed empty and full calibration and saved the values in the electronic insert and the sensor DAT.

7 Maintenance

No special maintenance work is required for the Liquicap M level transmitter.

External cleaning

When externally cleaning Liquicap M, make sure that the cleaning agent used does not attack or corrode the housing surface or seals.

Cleaning the probe

Depending on the application, buildup (contamination and soiling) can form on the probe rod. A high degree of material buildup can affect the measurement result. If the medium tends to create a high degree of buildup, regular cleaning is recommended. When hosing down or during mechanical cleaning, it is important to make sure that the insulation of the probe rod is not damaged. If cleaning agents are used make sure the material is resistant to them!

Seals

The process seals of the sensor should be replaced periodically, especially when using molded seals (aseptic version)! The intervals between seal replacement depend on the frequency of the cleaning cycles and on the fluid and cleaning temperature.

Repair

The Endress+Hauser repair concept is devised in such a way that the devices have a modular design and repairs can be carried out by the customers.

Spare parts are grouped into handy kits with related replacement instructions. The "Spare parts" section lists all the spare part kits, including the order numbers, which you can order from Endress+Hauser for repairing Liquicap M. For further information on service and spare parts, please contact Endress+Hauser Service.

Repairing Ex-certified devices

The following information also has to be taken into account when repairing Ex-certified devices:

- Ex-certified devices may only be repaired by experienced, skilled staff or by Endress+Hauser Service.
- Applicable standards, national Ex-area regulations as well as the Safety Instructions (XA) and certificates must be observed.
- Only genuine spare parts from Endress+Hauser may be used.
- When ordering spare parts, please note the device designation on the nameplate. Parts can only be replaced by the same parts.
- Repairs must be carried out in accordance with the instructions. Following a repair, the individual testing specified for the device must be carried out.
- Certified devices can only be converted to other certified device versions by Endress+Hauser Service.
- Every repair and conversion made to the device must be documented.

Replacement

After replacing a Liquicap M or the electronic insert, the calibration values must be transferred to the replacement device.

- When the probe is replaced, the calibration values in the electronic insert can be transferred to the sensor DAT (EEPROM) module via a manual download.
- When the electronic insert is replaced, the calibration values of the sensor DAT (EEPROM) module can be transferred to the electronics via a manual upload.

This means that you can restart the device without having to carry out a new calibration. (→  51 Sensor DAT (EEPROM) Upload/download.)

8 Accessories

8.1 Protective cover

For F13 and F17 housing
Order number: 71040497

For F16 housing
Order number: 71127760

8.2 Shortening set for FMI52

For Liquicap M FMI52 (no hygienic approval: EHEDG, 3A)
Order number: 942901-0001

8.3 Commubox FXA195 HART

For intrinsically safe HART communication with FieldCare via the RS232C interface or USB.

8.4 HAW56x surge arrester

Surge arrester for limiting overvoltage in signal lines and components: see Technical Information TI00401F.

8.5 Weld-in adapter

All the weld-in adapters available are described in the document TI00426F.
www.endress.com → Country → Download → Advanced → Documentation code → TI00426F.

9 Troubleshooting

The operating status of the device is indicated by the LEDs on the electronic insert.

9.1 Error messages at electronic insert

9.1.1 Green LED flashing

Green LED (⊕ indicates operation):

- Flashes every 5 s:
 - Indicates whether the device is operational
- Flashes once every s:
 - The device is in the calibration mode
- Flashes 4 times:
 - The device confirms a parameter change (function switch position 4, 5, 6)

9.1.2 Red LED flashing (⊖ indicates a fault)

Warning

- Flashes five times a s:
 - Capacitance at probe is too large
 - Probe insulation break detection
 - FEI50H is defective

The reasons for warnings include:

Alarm

- Flashes once every s:
 - The temperature in the electronic insert is outside the permitted temperature range.



Note!

For more accurate error analysis, see → 85 "Error codes".

9.2 System error messages

9.2.1 Error signal



Errors occurring during commissioning or during operation are displayed as follows:

- Error symbol, error code and error description on the display and operating module.
- Current output, can be configured ("Output on alarm" function)
 - MAX, 110 %, 22 mA
 - Hold (last value is retained)
 - User-spec. value

9.2.2 Last errors

With the "Last error" function ("System information" function group, "Error list" submenu), you can call up a list of the errors last rectified.

9.2.3 Types of error

Type of error	Display symbol	Meaning
Alarm (A)	 Permanent	The output signal assumes a value that can be specified with the "Output on alarm" function: <ul style="list-style-type: none"> ■ MAX: 110 %, 22 mA ■ Hold: Last value is retained ■ User-spec. value In addition, an error message is also shown on the display.
Warning (W)	 Flashing	The device continues measuring. An error message is shown on the display.

9.2.4 Error codes

The error codes shown on the display are 4-digit codes:

- Position 1: Type of error
 - A = Alarm
 - W = Warning
- Positions 2-4:
 Refer to the error in accordance with the following table

Example:

A 116	<ul style="list-style-type: none"> ■ A: Alarm ■ 116: Download error
-------	---

Code	Error description	Remedial action
A 101, A 102, A 110, A 152	Checksum error	Total reset and recalibration necessary
W 103, W153	Initializing - please wait	Replace the electronics if the message does not disappear after a few seconds
A 106	Downloading - please wait	Wait until the downloading is complete
A 111, A 112, A 113, A 114, A 115, A 155, A 164, A 171, A 404, A 405, A 407, A 408, A 409, A 410, A 411, A 412, A 413, A 414, A 415, A 416, A 417, A 418, A 421, A 422, A 423, A 424,	Electronics defective	Switch device off/on; if the error persists, Contact Endress+Hauser-Service
A 116	Download error	Repeat download or perform a total reset
A 426	Data of Sensor-DAT (EEPROM) not consistent	Repeat download from electronic insert or perform a total reset
A 427	Hardware not recognized after replacement	Repeat download or perform a total reset.
A 1121	Current output not calibrated	Contact Endress+Hauser-Service
W 153	Initializing	Replace the electronics if the message does not disappear after a few seconds
A 400	Measured capacitance too high	Change measuring range, verify probe
A 403	Measured capacitance too low	Verify probe
A 420	No sensor DAT (EEPROM) available	Exchange sensor

Code	Error description	Remedial action
A 428	Probe insulation break detection	Verify probe
W 425	Warning insulation defective	Check insulation
W 429	Proof test active	Wait until the proof test is completed
W 1601	Linearization curve not monotone for level	Re-enter linearization
A 1604	Calibration faulty	Correct calibration
W 1611	Level linearization points	Enter additional linearization points
W 1662	Temperature at electronic insert too high (max. temp. at sensor exceeded)	Lower ambient temperature by suitable measures
W 430	Data of probe and electronic insert not compatible	Check probe, perform a total reset
W 1671	Linearization table entered incorrectly	Readjust table
W 1681	Current outside measuring range	Perform basic setup; Check linearization
W 1683	Current turn down calibration faulty	Repeat calibration
W 1801	Level simulation switched on	Switch off level simulation
W 1802	Simulation switched on	Switch off simulation
W 1806	Current output is in simulation mode	Set current output to normal mode
W 511	Electronic insert has lost calibration data	Contact Endress+Hauser service



Note!

If none of the proposed remedial measures achieves the desired result, perform reset 2 → 50.

9.3 Possible measuring errors

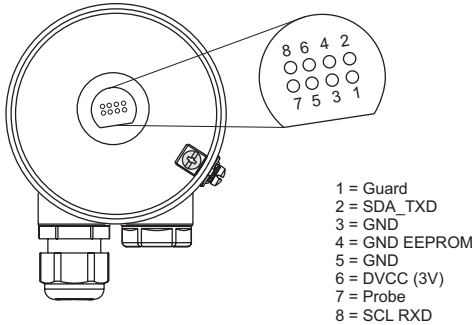
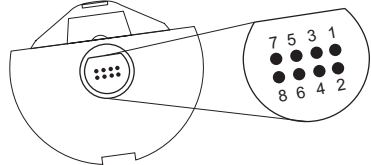
Error	Remedial measures
<p>Measured value is incorrect</p>	<ol style="list-style-type: none"> 1. Verify empty and full calibration. 2. Clean probe if necessary, verify probe 3. If necessary, alter better installation position of probe (do not mount in filling curtain) 4. Check ground from process connection to tank wall. Resistance measurement < 1 Ω 5. Check probe insulation (resistance measurement) > 800 kΩ (only possible for conductive media) <div style="text-align: center;"> <p>F16 housing</p>  <p>Electronic insert FEI50H</p>  </div> <p style="text-align: right; font-size: small;">BA298Fen080</p>
<p>If the surface is turbulent, the measured value jumps sporadically to higher levels</p>	<p>Increase output damping</p>

9.4 Spare Parts

An overview of the spare parts for your device is available in the internet at www.endress.com. To obtain information on the spare parts, proceed as follows:

1. Go to "www.endress.com" and select your country.
2. Click "Instruments".

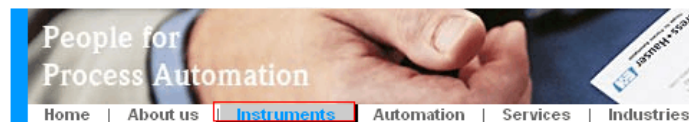

3. Enter the product name into the "product name" field.

Endress+Hauser product search

Via product name

Enter the product name

4. Select the device.
5. Click the "Accessories/Spare parts" tab.

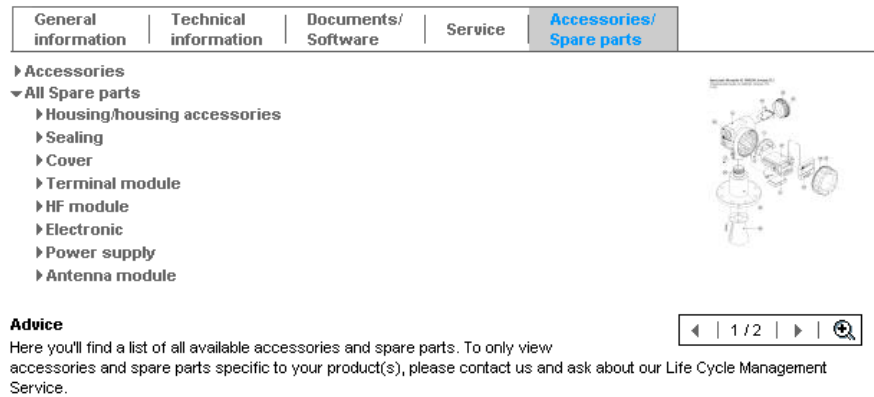

6. Select the required spare parts (You may also use the overview drawing on the right side of the screen.)

When ordering spare parts, always quote the serial number indicated on the nameplate. As far as necessary, the spare parts also include replacement instructions.

9.5 Return

The following measures must be taken before returning a device to Endress+Hauser for repair or calibration:

- Remove all traces of fluid. Pay particular attention to crevices and grooves for seals into which fluid can penetrate. This is particularly important if the fluid is hazardous to health, e.g. flammable, toxic, caustic, carcinogenic etc.
- Always enclose a fully completed "Declaration of Contamination" with the device (a master copy of the "Declaration of Contamination" can be found at the end of these Operating Instructions). Only then can Endress+Hauser check or repair a returned device.
- If necessary, enclose special handling instructions when returning the device, e.g. a safety data sheet in accordance with EN 91/155/EEC.

In addition, specify the following:

- The chemical and physical properties of the fluid
- A description of the application
- A description of the error that occurred (give error code where applicable)
- Operating time of the device

9.6 Disposal

When disposing of the device, make sure the device components are separated based on the materials used and recycled where possible.

9.7 Software history

Software-Version / Date	Software updates	Documentation
FW: V 01.00.xx / 08.2005	Original-Software. Operable with: FieldCare, version 2.08.00 and higher	-
FW: V 01.03.xx / 02.2007	Expansion feature suitable for SIL 2 applications	

10 Technical data

10.1 Technical data: probe

10.1.1 Capacitance values of the probe

- Basic capacitance: approx. 18 pF

10.1.2 Additional capacitance

- Mount the probe at a minimum distance of 50 mm from a conductive container wall:
 - Probe rod: approx. 1.3 pF/100 mm in air
 - Probe rope: approx. 1.0 pF/100 mm in air
- Fully insulated probe rod in water:
 - Approx. 38 pF/100 mm (16 mm rod)
 - Approx. 45 pF/100 mm (10 mm rod)
 - Approx. 50 pF/100 mm (22 mm rod)
- Insulated probe rope in water: approx. 19 pF/100 mm
- Rod probe with ground tube:
 - Insulated probe rod: approx. 6.4 pF/100 mm in air
 - Insulated probe rod: approx. 38 pF/100 mm in water (16 mm rod)
 - Insulated probe rod: approx. 45 pF/100 mm in water (10 mm rod)

10.1.3 Probe lengths for continuous measurement in conductive liquids

- Rod probe (range 0 to 2000 pF at ≤ 4000 mm)
- Rope probe < 6 m (range 0 to 2000 pF)
- Rope probe > 6 m (range 0 to 4000 pF)

10.2 Input

10.2.1 Measured variable

Continuous measurement of change in capacitance between probe rod and container wall or ground tube, depending on the level of a liquid.

Probe covered => high capacitance

Probe not covered => low capacitance

10.2.2 Measuring range

- Measuring frequency: 500 kHz
- Span: $\Delta C = 25$ to 4000 pF recommended (2 to 4000 pF possible)
- Final capacitance: $C_E = \text{max. } 4000$ pF
- Adjustable initial capacitance:
 - $C_A = 0$ to 2000 pF (< 6 m probe length)
 - $C_A = 0$ to 4000 pF (> 6 m probe length)

10.2.3 Measuring condition

- Measuring range L1 possible from the tip of the probe to the process connection.
- Particularly suited for small containers.

Note!

When installing in a nozzle, use inactive length (L3).

The 0 %, 100 % calibration can be inverted.

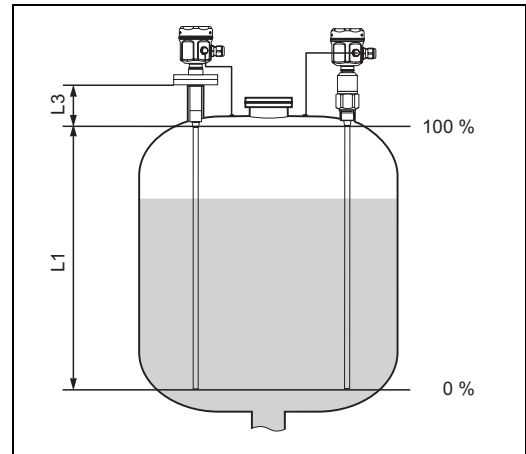

L00-FMI5xxx-15-05-xx-xx-002

10.3 Output

10.3.1 Output signal

FEI50H (4 to 20mA/HART version 5.0)

3.8 to 20.5 mA with HART protocol

10.3.2 Signal on alarm

Fault diagnosis can be called up via:

- Local display: Red LED
- Local display showing:
 - Error symbol
 - Plain text display
- Current output: 22 mA
- Digital interface: HART status error message

10.3.3 Linearization

The Liquicap M linearization function enables conversion of the measured value into any desired length or volume units. Linearization tables for volume calculation of horizontal cylindrical tanks and spherical tanks are pre-programmed. Any other tables with up to 32 value pairs can be input manually or semi-automatically.

10.4 Performance characteristics

10.4.1 Reference operating conditions

- Room temperature: +20 °C ±5 °C
- Span
 - Standard measuring range: 5 to 2000 pF
 - Extended measuring range: 5 to 4000 pF
 - Span for reference: 5 to 4000 pF (corresponds to approx. 1 m probe length)
- Non-repeatability (reproducibility) as per DIN 61298-2: max. ±0.1 %
- Non-linearity for limit point setting (linearity) as per DIN 61298-2: max. ±0.25 %

10.4.2 Maximum measured error

- Linearity: 0.5 %
- Reproducibility: 0.1 %

10.4.3 Influence of ambient temperature

< 0.06 %/10 K related to the full scale value

10.4.4 Switch-on behavior

14 s (stable measured value after switch-on procedure). Start-up in safe status (22mA).

10.4.5 Measured value reaction time

Operating mode: $t_1 \leq 0.3$ s

SIL operating mode: $t_1 \leq 0.5$ s

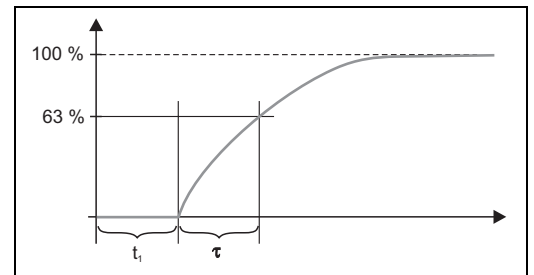

τ = Output damping
 t_1 = Dead time

10.4.6 Output damping

$\tau = 1$ s (factory setting) 0 to 60 s can be set.

The output damping affects the speed at which the display and the current output react to changes in the level.

10.4.7 Accuracy of factory calibration

	Probe length < 2 m	Probe length > 2 m
Empty calibration (0 %), Full calibration (100 %)	typically ≤ 5 mm	typically ≤ 2 %

Reference conditions for the factory calibration:

- Medium conductivity $\geq 100 \mu\text{S}/\text{cm}$
- Minimum distance to tank wall = 250 mm

Note!

In an installed state, recalibration is only necessary if:

- The 0 % or the 100 % values have to be adjusted specifically for customer
- The liquid is not conductive.
- The probe distance to the tank wall is < 250 mm

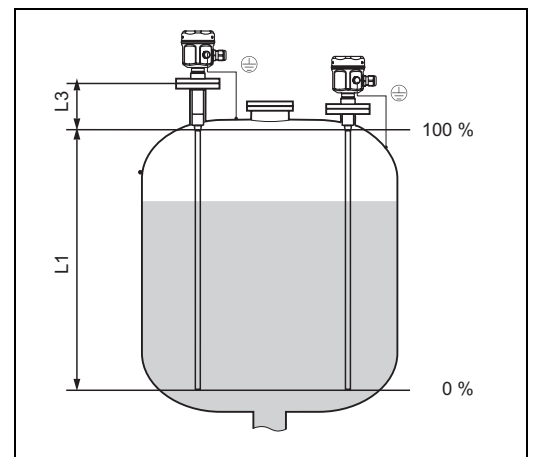

L00-FMI5xxxx-15-05-xx-xx-002

10.4.8 Resolution

Analog in % (4 to 20 mA)

- FMI51, FMI52: 11 bit/2048 steps, 8 µA
- The resolution of the electronics can be directly converted to units of length of the probe FMI51 or FMI52. For example, active probe rod 1000 mm.

$$\text{Resolution} = 1000 \text{ mm} / 2048 = 0.48 \text{ mm}$$

10.5 Operating conditions: Environment

10.5.1 Ambient temperature range

- -50 to +70 °C
- -40 to +70 °C (with F16 housing)
- Observe derating → 93
- If operating outdoors, use a protective cover! → 83.

10.5.2 Storage temperature

-50 to +85 °C

10.5.3 Climate class

DIN EN 60068-2-38/IEC 68-2-38: Z/AD check

10.5.4 Vibration resistance

DIN EN 60068-2-64/IEC 68-2-64: 20 Hz– 2000 Hz; 0.01 g²/Hz

10.5.5 Shock resistance

DIN EN 60068-2-27/IEC 68-2-27: 30g acceleration

10.5.6 Cleaning

Housing:

When cleaning, make sure that the cleaning agent used does not attack or corrode the housing surface or seals.

Probe:

Depending on the application, buildup (contamination and soiling) can form on the probe rod. A high degree of material buildup can affect the measurement result. If the medium tends to create a high degree of buildup, regular cleaning is recommended. When hosing down or during mechanical cleaning, it is important to make sure that the insulation of the probe rod is not damaged.

10.5.7 Degree of protection

	IP66*	IP67*	IP68*	NEMA4X*
Polyester housing F16	X	X	-	X
Stainless steel housing F15	X	X	-	X
Aluminum housing F17	X	X	-	X
Aluminum housing F13 with gas-tight process seal	X	-	X***	X
Stainless steel housing F27 with gas-tight process seal	X	X	X***	X

	IP66*	IP67*	IP68*	NEMA4X*
Aluminum housing T13 with gas-tight process seal and separate connection compartment (EEx d)	X	–	X***	X
Separate housing	X	–	X***	X

* As per EN60529

** As per NEMA 250

*** Only with M20 cable entry or G1/2 thread

10.5.8 Electromagnetic compatibility (EMC)

- Interference emission to EN 61326, Electrical Equipment Class B
Interference immunity to EN 61326, Annex A (Industrial) and NAMUR Recommendation NE 21 (EMC)
Failure current is acc. NAMUR NE43: FEI50H = 22mA
- A usual commercial instrument cable can be used.

10.6 Operating conditions: Process

10.6.1 Process temperature range

The following diagrams apply for:

- Rod and rope version
- Insulation: PTFE, PFA, FEP
- Standard applications outside hazardous areas



Note!

The temperature is restricted to $T_a -40\text{ °C}$ if the polyester housing F16 is used or if additional option B is selected (free from paint-wetting impairment substances, only FMI51).

With compact housing

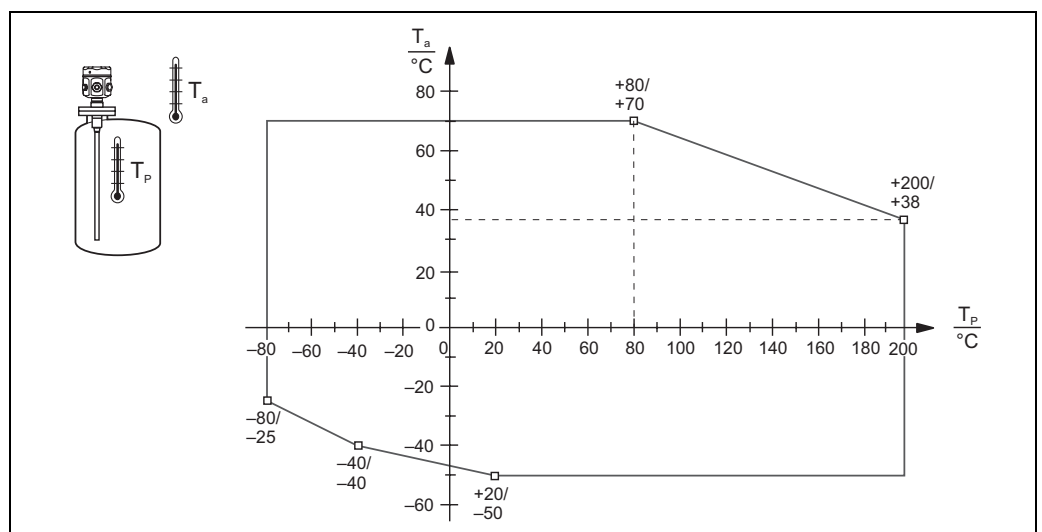

L00-FMI5xxxx-05-05-xxx-xx-013

T_a : Ambient temperature
 T_p : Process temperature

With separate housing

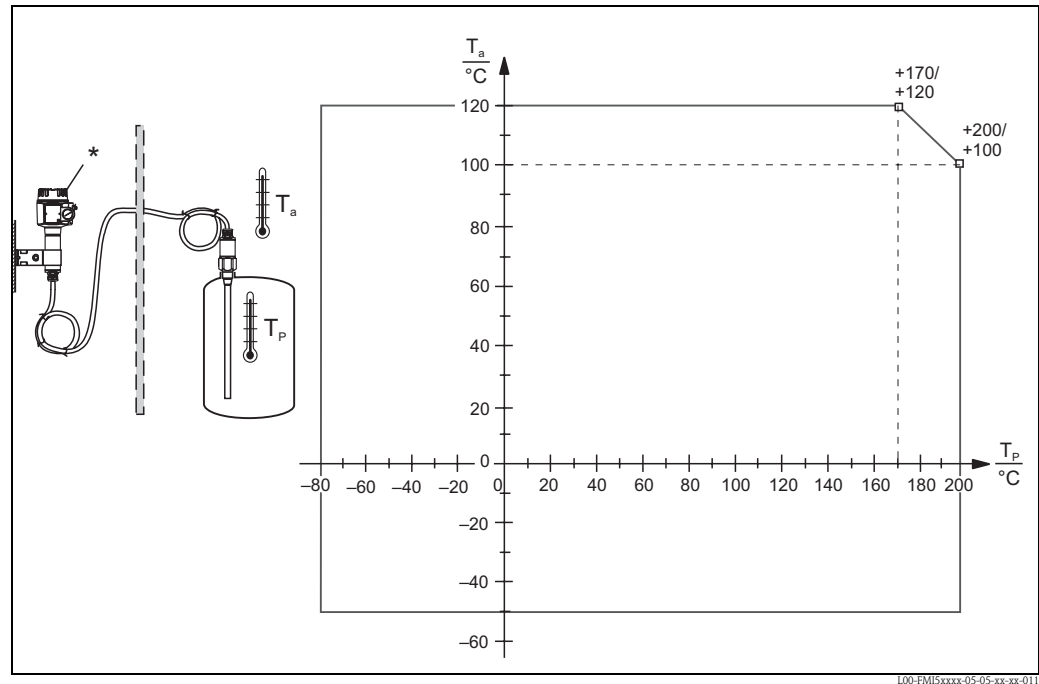

T_a = Ambient temperature

T_p = Process temperature

* The permitted ambient temperature at the separate housing is the same as indicated for the compact housing → 93.

10.6.2 Process pressure limits

Probe ø10 mm (including insulation)

-1 to 25 bar

Probe ø16 mm (including insulation)

- -1 to 100 bar
- In the event of an inactive length, the maximum permitted process pressure is 63 bar
- In the event of CRN approval and inactive length, the maximum permitted process pressure is 32 bar.

Probe ø22 mm (including insulation)

-1 to 50 bar

Refer to the following standards for the pressure values permitted at higher temperatures:

- EN 1092-1: 2005 Table, Appendix G2
With regard to its resistance/temperature property, the material 1.4435 is identical to 1.4404 (AISI 316L) which is grouped under 13E0 in EN 1092-1 Tab. 18. The chemical composition of the two materials can be identical.
- ASME B 16.5a - 1998 Tab. 2-2.2 F316
- ASME B 16.5a - 1998 Tab. 2.3.8 N10276
- JIS B 2220

The lowest value from the derating curves of the device and the selected flange applies.

10.6.3 Pressure and temperature derating

For process connections 1/2", 3/4", 1", flanges < DN50, < ANSI 2", < JIS 10K (10 mm rod)

For process connections 3/4", 1", flanges < DN50, < ANSI 2", < JIS 10K (16 mm rod)

Rod insulation: PTFE, PFA

Rope insulation: FEP, PFA

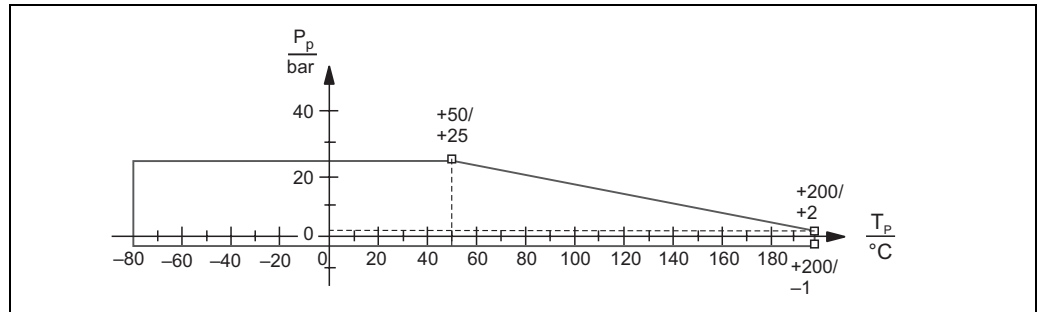

100-FMI5xxxx-05-05-xx-xx-008

P_p : Process pressure
 T_p : Process temperature

For process connections 1 1/2", flanges ≥ DN50, ≥ ANSI 2", ≥ JIS 10K (16 mm rod)

Rod insulation: PTFE, PFA

Rope insulation: FEP, PFA

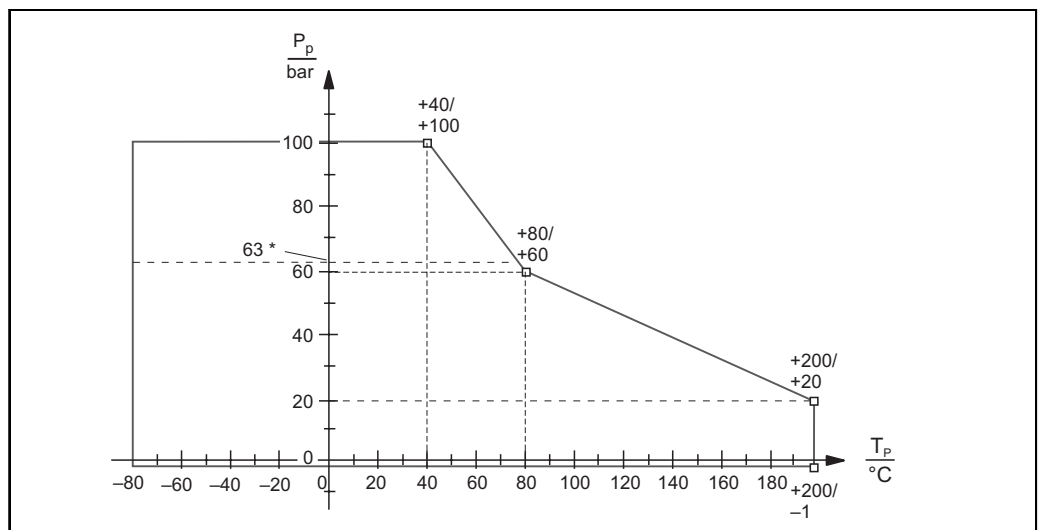

100-FMI5xxxx-05-05-xx-xx-010

P_p : process pressure
 T_p : process temperature
 * For probes with an inactive length .

With a fully insulated inactive length (22 mm rod):

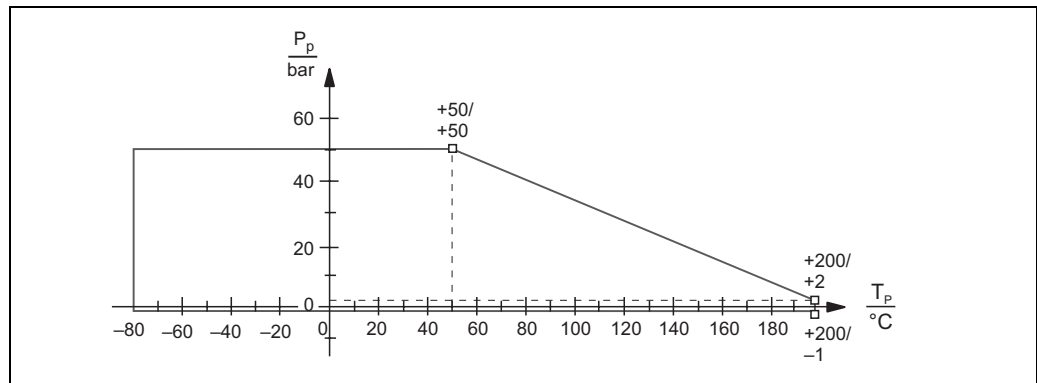

P_p : Process pressure
 T_p : Process temperature

L00-FMI5xxxx-05-05-xx-xx-012

10.7 Certificates and approvals

10.7.1 Other standards and guidelines

EN 60529

Degrees of protection by housing (IP code)

EN 61010

Protection measures for electrical equipment for measurement, control, regulation and laboratory procedures

EN 61326

Interference emission (Class B equipment), interference immunity (Annex A - Industrial).

NAMUR

Association for Standards for Control and Regulation in the Chemical Industry

IEC 61508

Functional safety

10.7.2 Other approvals

- See also "Identification" on → 5 onwards.
- TSE Certificate of Suitability (FMI51)
 The following applies to wetted device components:
 - They do not contain any materials derived from animals.
 - No additives or operating materials derived from animals are used in production or processing.

Note!

The wetted device components are listed in the "Identification" section (→ 5).

- AD2000

The wetted material (316L) corresponds to AD2000 – W0/W2

10.8 Documentation

10.8.1 Technical Information

- Liquicap M FMI51, FMI52
 TI00401F/00

10.8.2 Certificates

ATEX safety instructions

- Liquicap M FMI51, FMI52
ATEX II 1/2 G EEx ia IIC/IIB T3 to T6, II 1/2 D IP65 T 85 °C
XA00327F/00/a3
- Liquicap M FMI51, FMI52
ATEX II 1/2 G EEx d [ia] IIC/IIB T3 to T6
XA00328F/00/a3
- Liquicap M FMI51, FMI52
Ga/Gb Ex ia IIC T6 to T3; Ex ia D 20 / Ex tD A21 IP65 T90°C
XA00423F/00/a3

NEPSI safety instructions

- Liquicap M FMI51, FMI52
Ex ia IIC/IIB T3 to T6
XA00417F/00/a3
- Liquicap M FMI51, FMI52
EEx d [ia] IIC/IIB T3 to T6
XA00418F/00/a3
- Liquicap M FMI51, FMI52
Ex nA II T3 to T6, Ex nC IIC T3 to T6
XA00430F/00/a3

Overfill protection DIBt (WHG)

- Liquicap M FMI51, FMI52
ZE00265F/00/de

Functional safety (SIL2)

- Liquicap M FMI51, FMI52
SD00198F/00/en

Control Drawings (CSA and FM)

- Liquicap M FMI51, FMI52
FM
ZD00220F/00/en
- Liquicap M FMI51, FMI52
CSA
ZD00221F/00/en

CRN registration

- CRN OF1988.75

10.8.3 Patents

This product is protected by at least one of the following patents.
Further patents are pending.

- DE 103 22 279,
WO 2004 102 133,
US 2005 003 9528
- DE 203 13 695,
WO 2005 025 015

11 Operating menu





The main menu is activated by means of the right Enter key ↵.

The following menu headings appear. These are explained in more detail over the following pages:

- "Basic setup"
- "Safety set."
- "Linearization"
- "Output"
- "Device properties"

11.1 "Basic setup" menu Commissioning with display and operating module





You can make the following settings in the "Basic setup" menu.

Menu	Function	Subfunction	Function value
	 	 	
Basic setup	Basic setup	Medium property	no buildup ¹⁾ buildup
		Cal. type	Dry Wet
	Medium property ²⁾	Medium property	Conductive Nonconductive ³⁾ interface unknown
		DC value ⁴⁾	Value
		Unit level ⁵⁾	% (percentage) m mm ft inch
		Empty calibr.	Value empty Measure capacity Confirm cal.:
	Full calibr.	Value full Measure capacity Confirm cal.:	100 % xxxx pF Yes
		Output damping	Output damping

- 1) Factory settings are marked in "bold".
- 2) This function is only displayed if the function value "Dry" was selected under the subfunction "Cal. type".
- 3) This function value can only be selected for probes with a ground tube.
- 4) This subfunction is only displayed if the function value "Nonconductive" was selected under the subfunction "Medium property".
- 5) This subfunction is only displayed if the function value "Nonconductive" or "Conductive" was selected under the subfunction "Medium property".

11.2 "Safety setting" menu





You can make the following settings in the "Safety settings" menu.

Menu	Function	Subfunction	Function value
	 	 	
Safety settings	Safety settings I	Code	100 ¹⁾
		Status	Unlocked Locked
	Safety settings II	Operating mode	Standard SIL/WHG
		Output damping	1 s
		Output 1	MAX
		Parameter okay	no Yes
	Safety settings III	Cap. empty	x,xx pF
		Value empty	x,xxx %
		Cap. full	2000.00 pF
		Value full	100.000 %
		Parameter okay	no Yes
	Operating mode	Operating mode	Standard SIL/WHG
			SIL op. mode ²⁾
		Status	Unlocked Locked
	Output on alarm	Output	Max Hold User-spec.
			Output value ³⁾
	Proof test	Proof test	Off On

- 1) Factory settings are marked in "bold".
- 2) This subfunction is only displayed if the "SIL/WHG" option was selected under the "Operating mode" subfunction.
- 3) This subfunction is only displayed if the "User-specific" option was selected under the "Output" subfunction.

11.3 "Linearization" menu





You can do the following settings in the "Linearization" menu.

Menu	Function	Subfunction	Function value	Additional function values
	 	 		
Linearization	Linearization	Type	None Linear ¹⁾ Horizontal cyl ²⁾ Sphere ²⁾ Pyramid bottom ³⁾ Conical bottom ³⁾ Angled bottom ³⁾ Table	
		Mode	level Ullage	
		Simulation	Sim. off Sim. level Sim. volume	
		Sim. level value ⁴⁾ or Sim. vol. value ⁴⁾	xx.x % xx.x %	
	Linearization	Customer unit	% (percentage), l, hl, m3, dm3, cm3, ft3, usgal, igital, kg, t, lb, ton, m3, ft3, mm, inch, user-spec.	
		Customized text ⁵⁾	...	
		Diameter ⁶⁾	xxxx m	
		Intermed. height ⁷⁾	xx m	
		Edit ⁸⁾	Read Manual Semi-automat. Delete	Table No.: 1 Input level: x m Input volume: % Table No.: 1 Input level: x m Input volume: % Table No.: 1 Input level: x m Input volume: %
		Status table ⁷⁾	Enabled Disabled	
		Max. scale ⁹⁾	100 %	

- 1) Factory settings are marked in "bold".
- 2) If you enter a value for this function, you must also enter a value for the "Diameter" subfunction in another step.
- 3) If you enter a value for this function, you must also enter a value for the "Intermed. height" subfunction in another step.
- 4) This function is only displayed if the "Sim. off" option was not selected under the "Simulation" subfunction.
- 5) This function is only displayed if the "User-spec." option was selected under the "Customer unit" subfunction.
- 6) This function is only displayed if the "Horizontal cyl" or "Sphere" option was selected under the "Type" subfunction.
- 7) This function is only displayed if the "Pyramid bottom", "Conical bottom" or "Angled bottom" option was selected under the "Type" subfunction.
- 8) This function is only displayed if the "Table" option was selected under the "Type" subfunction.
- 9) This function is not displayed if the "Table" option was selected under the "Type" subfunction.

11.4 "Output" menu





You can do the following settings in the "Output" menu.

Menu	Submenu	Function	Subfunction	Function value	
	 	 			
Output	Extended calibr.	Extended calibr.	Measuring range	2000 pF¹⁾ 4000 pF	
			Sensor DAT Stat.	OK	
			Sensor DAT	Upload Download	
			Output/Calculat	Curr. turn down	On Off
			Turn down 4 mA ²⁾	0 %	
			Turn down 20 mA ²⁾	100 %	
			4 mA threshold	On Off	
	HART setting	HART setting	HART address	0	
			No. of preambles	5	
			Short TAG HART	TAG	
	Output/Calculat	Output/Calculat	Current span	4 to 20 mA Fix. curr. HART	
			mA value ³⁾	4 mA	
	Simulation	Simulation	Simulation	Off On	
			Simulation value ⁴⁾	xx.xx mA	

- 1) Factory settings are marked in "bold".
- 2) This function is only displayed if the "On" option was selected under the "Curr. turn down" subfunction.
- 3) This function is only displayed if the function value "Fix. curr. HART" was selected under the "Current span" subfunction.
- 4) This function is only displayed if the "On" option was selected under the "Simulation" function.

11.5 "Device properties" menu

You can do the following settings in the "Device properties" menu.

Menu	Submenu	Function	Subfunction	Function value
	 	 		
Device properties	Display	Language		English Deutsch Francais Espanol Italiano Nederlands
		Display format	Format	Decimal ft-in-1/16"
			No of decimals	x x.x x.xx x.xxx
			Sep. character	. (dot) ,
			Back to home	900 s
	Diagnostics	Actual error	Actual error 1 Actual error 2 Actual error 3
		Last error	reset errorlist Last error 2 Last error 3	Keep Delete
		Password/reset	Reset Status	12345 Unlocked
		Electronic temp.	Electronic temp. Max. temp. Min. temp. Temperature unit Min/Max temp.	xx.x °C xx.x °C xx.x °C °C °F K Keep Delete Reset Min. Reset Max.
		Measure capacity	Measure capacity Max. capacity val Min. capacity val Min/Max capacity	xxxx.xx pF xxxx.xx pF xxxx.xx pF Keep Delete Reset Min. Reset Max.
	System parameters	Device information I	Device designation Serial No. EC Serial No. Device marking	Liquicap-FMI5x ... xxxxxxxxxxxx FMI51-OrderCode
		Device information	Dev. rev Software version DD version	x V01.xx.xx.xxx xx
		Device information III	Working hour Current run time	xxxxx h 000d00h00m
		Probe length	Probe length Sensitivity	xxx mm 0.0

Index

Numerics

4 mA threshold 71

A

Accessories 84
 Actual error 74
 Aligning the housing 25

B

Basic setup 48, 53, 55

C

Cable specification 27
 Cal. type 55
 Calibration error 88
 Cap. empty 57, 60
 Cap. full 60
 CapCalc 56, 79
 Carrying out empty calibration 49
 CE mark 12
 Certificates and approvals 97
 Code 59
 Commissioning 48
 Commubox 84
 Commubox FXA191/195 HART 84
 Confirm cal.
 56
 Connection 28, 31
 Curr. turn down 70
 Current run time 76
 Current span 71
 Customer unit 66
 Customized text 67

D

DC value 55
 DD version 76
 Declaration of Conformity 12
 Declaration of Contamination 89
 Designated use 3
 Dev. rev 76
 Device designation 76
 Device information 76
 Device marking 76
 Device properties 53, 73
 Diagnostics 74
 Diameter 67
 Display and operating elements (FEI50H) 33
 Display and operating module 34, 53
 Display format 74
 Display symbols 34
 Disposal 89
 Download/upload sensor DAT 52
 Dry calibration 53
 Dry calibration for interface measurement 80

E

EC Serial No. 76
 Edit 67
 Editing functions with the picklist 41
 Editing numeric functions 42
 Electrical symbols 4
 Electromagnetic compatibility (EMC) 27
 Electronic temp. 75
 Empty calibr. 56
 Empty calibration ("Dry" operating mode) 57
 Error codes 86
 Error signal 85
 Ex area 3
 Extended calibr. 69
 External cleaning 83

F

Fieldbus connector 28
 Full calibr. 56
 Full calibration ("Dry" operating mode) 57
 Function and subfunction 40
 Function switch 49

G

Green LED flashing 85
 Ground tube 17

H

Handheld terminal DXR375 47
 HART 31
 HART - connecting with other supply units 31
 HART address 71
 HART handheld terminal DXR 375 47
 HART settings 71

I

Inactive length 17
 Incoming acceptance 13
 Initial commissioning 53
 Installation 13
 Installation and function check 48
 Intermed. height 67

K

Key combinations 35
 Key locking 45
 Key unlocking 45
 Keys (softkey operation) 35

L

Language 74
 Last error 74
 Last errors 85
 Launching menus 38
 Linearization 53, 63, 66
 Locking 45

M

Maintenance	83
Marine approval (GL)	15
Max. capacity	75
Max. scale	68
Max. temp.	75
Measure capacity	56, 75
Measured value display	44
Measuring condition	15
Measuring modes	49
Measuring range	26, 51, 69
Medium	49, 55
Medium property	49, 55
Menu-guided commissioning	46
Min. capacity	75
Min. temp.	75
Min/Max capacity	75
Min/Max temp.	75
Mode	66

N

Nameplate	5
Navigating in the menu	37
Next highest	45
No. of decimals	74
No. of preambles	71
Notes on safety conventions and icons	4

O

Operating menu	36
Operating menu (overview)	99
Operating mode	60–61
Operating options	32
Operation	77
Operational safety	3
Orientation	14
Output	53, 69
Output 1	60
Output damping	58, 60–61
Output on alarm	62
Output value	62
Output/Calculat	71
Output/calculat.	70

P

Parameter okay	60–61
Password/reset	74
Performance characteristics	91
Pipe mounting	23
Planning instructions	14
Post-connection check	31
Post-installation check	26
Potential equalization	27
Probe length	76
Proof test	51, 62
Protective cover	84

R

Red LED flashing	85
Repair	83

Repairing Ex-certified devices	83
Replacement	83
Reset	45, 51, 75
Restore factory settings	51
Return	89
Rod probes	16
Rope probes	19
Rotating the housing	25

S

Safety instructions	3–4
Safety setting	53, 59
Safety settings	59
Sealing (housing)	26
Seals	83
Self-test	51
Sensor DAT	70
Sensor DAT stat.	70
Sep. character	74
Separate housing	21
Separate housing (shortening the connecting cable)	23
Serial No.	76
Short TAG HART	71
Shortening set	84
Shortening the rope	20
SIL operating mode	61
Sim. level value	66
Sim. vol. value	66
Simulation	66, 72
Simulation value	72
Software history	89
Software locking	45
Software version	76
Spare Parts	88
Status	60–61
Status table	68
Storage	13
Storage temperature	13
Submenus	39
System parameters	76

T

Table editor	67
Technical data	90
Temperature unit	75
Tensioning weight with tension	20
ToF Tool	31, 46
ToF Tool - FieldTool Package	46
Troubleshooting	85
Troubleshooting instructions	85
Turn down 20 mA	70
Turn down 4 mA	70
Type	64
Type of protection	4
Types of error	86

U

Unit level	56
------------	----

V

Value empty 56–57, 60
Value full 56, 60

W

Wall bracket 22
Wall mounting 22
Wet calibration
..... 53
Wiring 27
Working hour 76

Declaration of Hazardous Material and De-Contamination *Erklärung zur Kontamination und Reinigung*

RA No.

Please reference the Return Authorization Number (RA#), obtained from Endress+Hauser, on all paperwork and mark the RA# clearly on the outside of the box. If this procedure is not followed, it may result in the refusal of the package at our facility.

Bitte geben Sie die von E+H mitgeteilte Rücklieferungsnummer (RA#) auf allen Lieferpapieren an und vermerken Sie diese auch außen auf der Verpackung. Nichtbeachtung dieser Anweisung führt zur Ablehnung ihrer Lieferung.

Because of legal regulations and for the safety of our employees and operating equipment, we need the "Declaration of Hazardous Material and De-Contamination", with your signature, before your order can be handled. Please make absolutely sure to attach it to the outside of the packaging.

Aufgrund der gesetzlichen Vorschriften und zum Schutz unserer Mitarbeiter und Betriebseinrichtungen, benötigen wir die unterschriebene "Erklärung zur Kontamination und Reinigung", bevor Ihr Auftrag bearbeitet werden kann. Bringen Sie diese unbedingt außen an der Verpackung an.

Type of instrument / sensor

Geräte-/Sensortyp _____

Serial number

Seriennummer _____

Used as SIL device in a Safety Instrumented System / Einsatz als SIL Gerät in Schutzeinrichtungen

Process data / Prozessdaten

Temperature / Temperatur _____ [°F] _____ [°C] Pressure / Druck _____ [psi] _____ [Pa]
Conductivity / Leitfähigkeit _____ [µS/cm] Viscosity / Viskosität _____ [cp] _____ [mm²/s]

Medium and warnings

Warnhinweise zum Medium



	Medium / concentration <i>Medium / Konzentration</i>	Identification CAS No.	flammable <i>entzündlich</i>	toxic <i>giftig</i>	corrosive <i>ätzend</i>	harmful/ irritant <i>gesundheitsschädlich/ reizend</i>	other * <i>sonstiges*</i>	harmless <i>unbedenklich</i>
Process medium <i>Medium im Prozess</i>								
Medium for process cleaning <i>Medium zur Prozessreinigung</i>								
Returned part cleaned with <i>Medium zur Endreinigung</i>								

* explosive; oxidising; dangerous for the environment; biological risk; radioactive

* *explosiv; brandfördernd; umweltgefährlich; biogefährlich; radioaktiv*

Please tick should one of the above be applicable, include safety data sheet and, if necessary, special handling instructions.

Zutreffendes ankreuzen; trifft einer der Warnhinweise zu, Sicherheitsdatenblatt und ggf. spezielle Handhabungsvorschriften beilegen.

Description of failure / Fehlerbeschreibung _____

Company data / Angaben zum Absender

Company / Firma _____	Phone number of contact person / Telefon-Nr. Ansprechpartner: _____
Address / Adresse _____	Fax / E-Mail _____
_____	Your order No. / Ihre Auftragsnr. _____

"We hereby certify that this declaration is filled out truthfully and completely to the best of our knowledge. We further certify that the returned parts have been carefully cleaned. To the best of our knowledge they are free of any residues in dangerous quantities."

"Wir bestätigen, die vorliegende Erklärung nach unserem besten Wissen wahrheitsgetreu und vollständig ausgefüllt zu haben. Wir bestätigen weiter, dass die zurückgesandten Teile sorgfältig gereinigt wurden und nach unserem besten Wissen frei von Rückständen in gefahrbringender Menge sind."

(place, date / Ort, Datum)

Name, dept./Abt. (please print / bitte Druckschrift)

Signature / Unterschrift

www.endress.com/worldwide

Endress+Hauser 
People for Process Automation

