

Operating Instructions

Deltabar FMD71, FMD72

Level measurement with electronic differential pressure
Electronic differential pressure transmitter with ceramic
and metal sensors

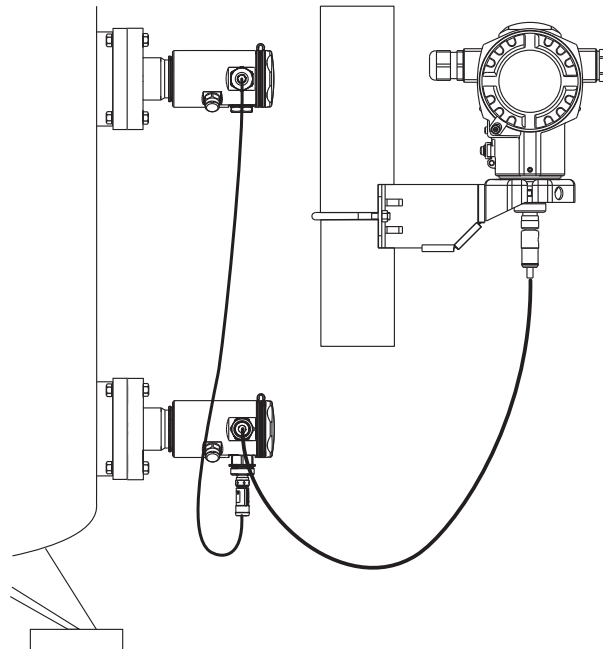

Table of contents

1	Document information	5	8	Operation without an operating menu	30
1.1	Document function	5	8.1	Position of operating elements	30
1.2	Symbols used	5	9	Operation with an operating menu	32
1.3	Documentation	7	9.1	Operating concept	32
1.4	Registered trademarks	8	9.2	Structure of the operating menu	32
2	Basic safety instructions	9	9.3	Operating options	33
2.1	Requirements concerning the staff	9	9.4	Operating the device using onsite display (optional)	33
2.2	Designated use	9	9.5	Operation using Endress+Hauser operating program	36
2.3	Workplace safety	10	9.6	Direct access to parameters	37
2.4	Operational safety	10	9.7	Locking/unlocking operation	37
2.5	Product safety	10	9.8	Resetting to factory settings (reset)	38
3	Product description	11	10	Integrating transmitter using HART® protocol	40
3.1	Product design	11	10.1	HART process variables and measured values	40
3.2	Function	12	10.2	Device variables and measured values	41
3.3	Registered trademarks	12	11	Commissioning	42
4	Incoming acceptance and product identification	13	11.1	Function check	42
4.1	Incoming acceptance	13	11.2	Unlocking/locking configuration	42
4.2	Product identification	14	11.3	Commissioning without an operating menu ..	42
4.3	Nameplates	14	11.4	Commissioning with an operating menu	45
5	Storage and transport	17	11.5	Selecting the language, measuring mode, high-pressure side, and pressure engineering unit	45
5.1	Storage conditions	17	11.6	Pos. Zero Adjust	47
5.2	Transporting the product to the measuring point	17	11.7	Configuring level measurement	48
6	Installation	18	11.8	Linearization	58
6.1	Mounting dimensions	18	11.9	Configuring pressure measurement	61
6.2	Mounting location	18	11.10	Backing up or duplicating the device data	62
6.3	Orientation	18	11.11	Configuring the local display	63
6.4	General installation instructions	18	11.12	Protecting settings from unauthorized access	63
6.5	Thermal insulation - FMD71 high-temperature version	19	12	Diagnostics and troubleshooting ...	64
6.6	Installing the sensor modules	20	12.1	Troubleshooting	64
6.7	Installing the transmitter	21	12.2	Diagnostic events	64
6.8	Closing the housing covers	22	12.3	Response of output to errors	68
6.9	Seal for flange mounting	22	12.4	Firmware history	68
6.10	Post-installation check	23	12.5	Disposal	68
7	Electrical connection	24	13	Maintenance	69
7.1	Connecting the sensor module LP to the sensor module HP	24	13.1	Exterior cleaning	69
7.2	Connecting the sensor module HP to the transmitter	25			
7.3	Connecting the measuring unit	26			
7.4	Connection conditions	27			
7.5	Connection data	28			
7.6	Post-connection check	29			

14	Repair	70
14.1	General notes	70
14.2	Spare parts	71
15	Return	72
16	Overview of the operating menu	73
17	Description of device parameters ...	78
18	Registered trademarks	108
18.1	HART®	108
19	Technical data	109
Index	110





1 Document information

1.1 Document function







These Operating Instructions contain all the information that is required in various phases of the life cycle of the device: from product identification, incoming acceptance and storage, to mounting, connection, operation and commissioning through to troubleshooting, maintenance and disposal.

1.2 Symbols used





1.2.1 Safety symbols

Symbol	Meaning
 A0011189-EN	DANGER! This symbol alerts you to a dangerous situation. Failure to avoid this situation will result in serious or fatal injury.
 A0011190-EN	WARNING! This symbol alerts you to a dangerous situation. Failure to avoid this situation can result in serious or fatal injury.
 A0011191-EN	CAUTION! This symbol alerts you to a dangerous situation. Failure to avoid this situation can result in minor or medium injury.
 A0011192-EN	NOTICE! This symbol contains information on procedures and other facts which do not result in personal injury.





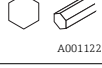





1.2.2 Electrical symbols

Symbol	Meaning
 A0011197	Direct current A terminal to which DC voltage is applied or through which direct current flows.
 A0011198	Alternating current A terminal to which alternating voltage is applied or through which alternating current flows.
 A0017381	Direct current and alternating current <ul style="list-style-type: none"> ▪ A terminal to which alternating voltage or DC voltage is applied. ▪ A terminal through which alternating current or direct current flows.
 A0011200	Ground connection A grounded terminal which, as far as the operator is concerned, is grounded via a grounding system.
 A0011199	Protective ground connection A terminal which must be connected to ground prior to establishing any other connections.
 A0011201	Equipotential connection A connection that has to be connected to the plant grounding system: This may be a potential equalization line or a star grounding system depending on national or company codes of practice.

1.2.3 Tool symbols



Symbol	Meaning
 A0013442	Torx screwdriver
 A0011220	Flat blade screwdriver
 A0011219	Cross-head screwdriver
 A0011221	Allen key
 A0011222	Hexagon wrench

1.2.4 Symbols for certain types of information

Symbol	Meaning
 A0011182	Permitted Indicates procedures, processes or actions that are permitted.
 A0011183	Preferred Indicates procedures, processes or actions that are preferred.
 A0011184	Forbidden Indicates procedures, processes or actions that are forbidden.
 A0011193	Tip Indicates additional information.
 A0011194	Reference to documentation Refers to the corresponding device documentation.
 A0011195	Reference to page Refers to the corresponding page number.
 A0011196	Reference to graphic Refers to the corresponding graphic number and page number.
	Series of steps
	Result of a sequence of actions
 A0013562	Help in the event of a problem
 A0015502	Visual inspection

1.2.5 Symbols in graphics

Symbol	Meaning
1, 2, 3 ...	Item numbers
1., 2., 3. ...	Series of steps
A, B, C, ...	Views
A-A, B-B, C-C, ...	Sections

Symbol	Meaning
 A0011187	Hazardous area Indicates a hazardous area.
 A0011188	Safe area (non-hazardous area) Indicates the non-hazardous area.

1.3 Documentation



The document types listed are available:

- On the CD supplied with the device
- In the Download Area of the Endress+Hauser Internet site: www.endress.com → Download

1.3.1 Technical Information TI01033P: helps in planning your device

The document contains all the technical data on the device and provides an overview of the accessories and other products that can be ordered for the device.

1.3.2 Brief Operating Instructions KA01105P: getting the 1st measured value quickly

The Brief Operating Instructions contain all the essential information from incoming acceptance to initial commissioning.

1.3.3 Description of Device Parameters GP01013P: reference for your parameters

The document provides a detailed explanation of each individual parameter in the operating menu. The description is aimed at those who work with the device over the entire life cycle and perform specific configurations.

1.3.4 Safety Instructions (XA)

Safety Instructions (XA) are supplied with the device depending on the approval. These instructions are an integral part of the Operating Instructions.

Device	Certificate/type of protection	Documentation	Version ¹⁾
FMD71, FMD72	ATEX II 1/2G Ex ia IIC T6 Ga/Gb	XA00619P	BA
FMD71, FMD72	ATEX II 1/2G Ex d [ia] IIC T6 Ga/Gb	XA00620P	BC
FMD71, FMD72	ATEX II 3G Ex nA IIC T6 GC	XA00621P	BD
FMD71, FMD72	IEC Ex ia IIC T6 Ga/Gb	XA00622P	IA
FMD71, FMD72	IEC Ex d [ia] IIC T6 Ga/Gb	XA00623P	IB
FMD71, FMD72	CSA General Purpose	-	CD
FMD71	FM C/US IS Cl.I Div.1 Gr.A-D, AEx ia, Zone 0,1,2	XA00628P	FA
FMD71	FM C/US XP AIS Cl.I Div.1 Gr.A-D, Exd [ia] Zone 0,1,2	XA00629P	FB
FMD71	CSA C/US XP Cl.I Div.1 Gr.A-D, Ex d [ia], Zone 0,1,2	XA00631P	CB
FMD71	FM C/US NI Cl.I Div.2 Gr.A-D, Zone 2	XA00668P	FD
FMD71	CSA C/US NI, Cl.I Div. 2, Gr.A-D Cl.I, Zone 2, IIC	XA00670P	CC
FMD71	CSA C/US IS Cl.I Div.1 Gr.A-D, Ex ia Zone 0,1,2	XA00630P	CA
FMD72	CSA C/US IS Cl.I Div.1 Gr.A-D, Ex ia Zone 0,1,2	XA00626P	CA

Device	Certificate/type of protection	Documentation	Version ¹⁾
FMD72	CSA C/US XP Cl.I Div.1 Gr.A-D, Ex d [ia], Zone 0,1,2	XA00627P	CB
FMD72	CSA C/US NI, Cl.I Div.2 Gr.A-D, Zone 2	XA00671P	CC
FMD72	FM C/US IS Cl.I Div.1 Gr.A-D, AEx ia, Zone 0,1,2	XA00624P	FA
FMD72	FM C/US XP AIS Cl.I Div.1 Gr.A-D, Exd [ia] Zone 0,1,2	XA00625P	FB
FMD72	FM C/US NI Cl.I Div.2 Gr.A-D, Zone 2	XA00669P	FD

1) Product Configurator, "Approval" section

 The nameplate provides information on the Safety Instructions (XA) that are relevant for the device.

1.4 Registered trademarks

1.4.1 HART®

Registered trademark of the HART Communication Foundation, Austin, USA

2 Basic safety instructions

2.1 Requirements concerning the staff

The personnel for installation, commissioning, diagnostics and maintenance must fulfill the following requirements:

- ▶ Trained, qualified specialists: must have a relevant qualification for this specific function and task
- ▶ Are authorized by the plant owner/operator
- ▶ Are familiar with federal/national regulations
- ▶ Before beginning work, the specialist staff must have read and understood the instructions in the Operating Instructions and supplementary documentation as well as in the certificates (depending on the application)
- ▶ Following instructions and basic conditions

The operating personnel must fulfill the following requirements:

- ▶ Being instructed and authorized according to the requirements of the task by the facility's owner-operator
- ▶ Following the instructions in these Operating Instructions

2.2 Designated use

2.2.1 Application and media

The Deltabar FMD72 is a differential pressure transmitter for measuring differential pressure and level in pressurized tanks. The device has two sensor modules, which measure the operating pressure (High Pressure HP and Low Pressure LP). The differential pressure/hydrostatic level is calculated in the transmitter unit. The sensor signal is transmitted digitally. In addition, sensor temperatures and the individual process pressures present at the respective sensor modules can be individually evaluated and transmitted. If the limit values specified in the "Technical Data" and the conditions listed in the instructions and additional documentation are observed, the measuring device may be used for the following measurements (process variables):

Measured process variables

- Pressure HP and Pressure LP
- Sensor temperature

Calculated process variables

- Differential pressure
- Level (level, volume or mass)

2.2.2 Incorrect use

The manufacturer is not liable for damage caused by improper or non-designated use.

Verification for borderline cases:

- ▶ For special fluids and fluids for cleaning, Endress+Hauser is glad to provide assistance in verifying the corrosion resistance of fluid-wetted materials, but does not accept any warranty or liability.

2.2.3 Residual risks

Due to heat transfer from the process as well as power loss in the electronics, the temperature of the electronics housing and the assemblies contained therein (e.g. display module, main electronics module and I/O electronics module) may rise up to 80 °C (176

°F). When in operation, the sensor may reach a temperature close to the medium temperature.

Danger of burns from contact with surfaces!

- ▶ For elevated fluid temperature, ensure protection against contact to prevent burns.

2.3 Workplace safety

For work on and with the device:

- ▶ Wear the required personal protective equipment according to federal/national regulations.
- ▶ Switch off the supply voltage before connecting the device.

2.4 Operational safety

Risk of injury!

- ▶ Operate the device in proper technical condition and fail-safe condition only.
- ▶ The operator is responsible for interference-free operation of the device.

Conversions to the device

Unauthorized modifications to the device are not permitted and can lead to unforeseeable dangers

- ▶ If, despite this, modifications are required, consult with Endress+Hauser.

Repair

To ensure continued operational safety and reliability,

- ▶ Carry out repairs on the device only if they are expressly permitted.
- ▶ Observe federal/national regulations pertaining to repair of an electrical device.
- ▶ Use original spare parts and accessories from Endress+Hauser only.

Hazardous area

To eliminate a danger for persons or for the facility when the device is used in the hazardous area (e.g. explosion protection, pressure vessel safety):

- ▶ Based on the nameplate, check whether the ordered device is permitted for the intended use in the hazardous area.
- ▶ Observe the specifications in the separate supplementary documentation that is an integral part of these Instructions.

2.5 Product safety

This measuring device is designed in accordance with good engineering practice to meet state-of-the-art safety requirements, has been tested, and left the factory in a condition in which they are safe to operate.

It fulfills general safety requirements and legal requirements. It also conforms to the EC directives listed in the device-specific EC declaration of conformity. Endress+Hauser confirms this fact by applying the CE mark.

3 Product description

3.1 Product design

Level measurement (level, volume and mass) with Deltabar:

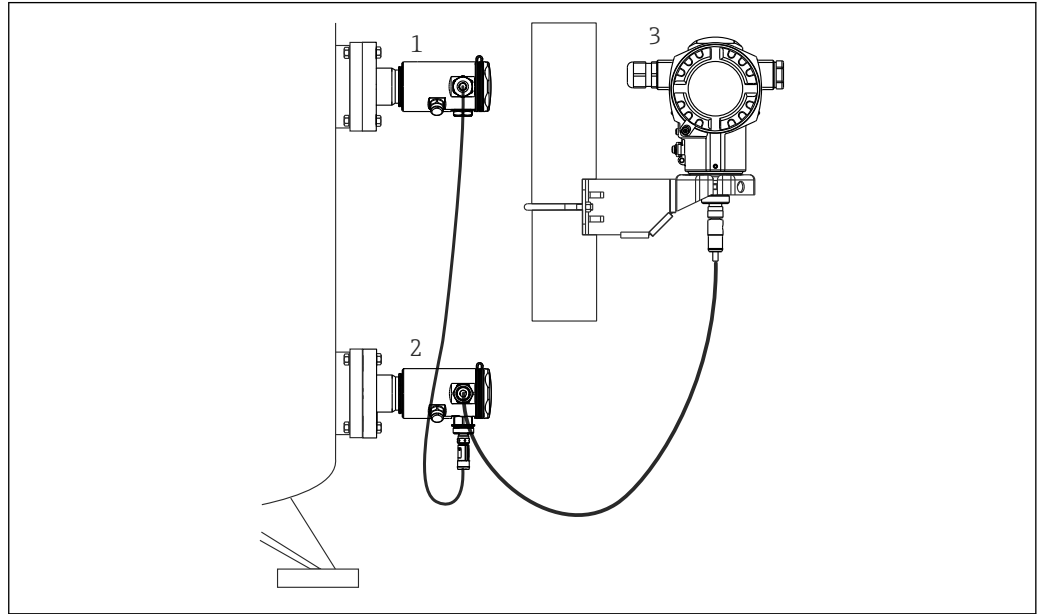

A0016449

- 1 *Sensor module LP*
- 2 *Sensor module HP*
- 3 *Transmitter*

The FMD71/FMD72 is best suited to level measurement in tanks with pressure overlay or vacuum vessels and tanks, high distillation columns and other vessels with changing ambient temperatures.

The sensor module HP is mounted on the lower measuring connection and the sensor module LP is mounted above the maximum level. The transmitter can be mounted on pipes or walls with the mounting bracket.

The sensor signal is transmitted digitally. In addition, sensor temperatures and the individual process pressures present at the respective sensor modules can be individually evaluated and transmitted.

3.2 Function

3.2.1 Differential pressure generation

The measurement chain for the calculation of the differential pressure can be represented by the following diagram:

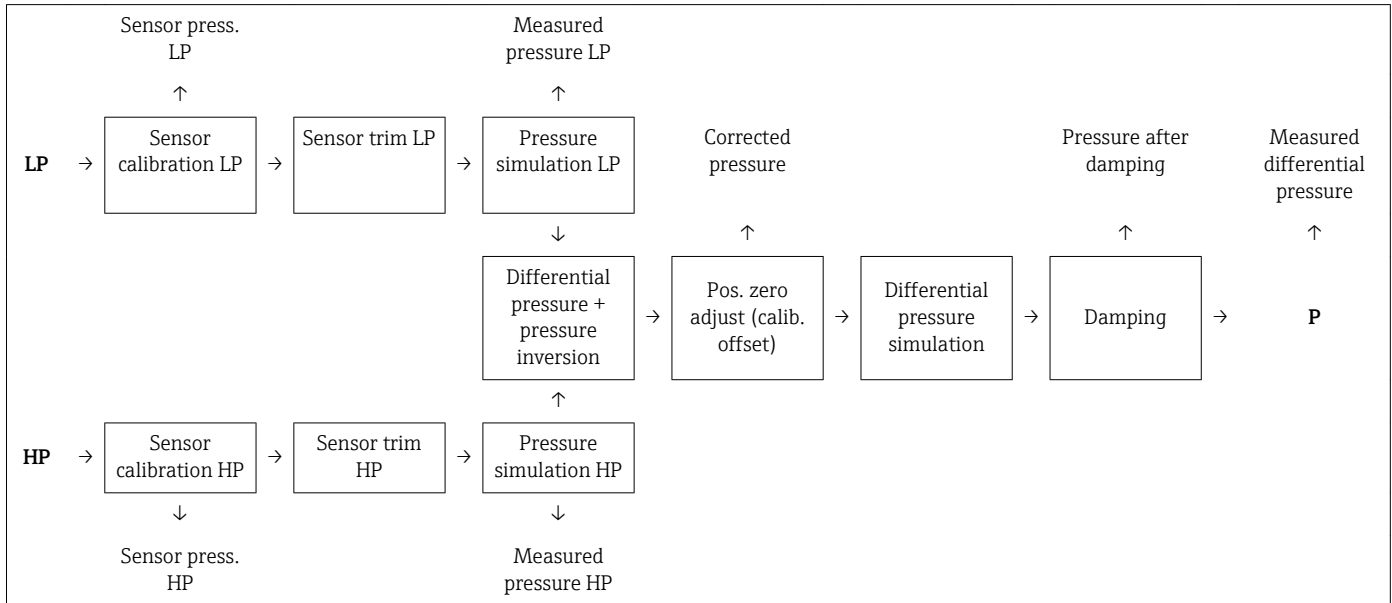

All the process values represented on the diagram are updated in a measurement cycle. The sensor module allocation is determined by the configuration when setting up the device. The connection to the transmitter defines the corresponding sensor module as the master. After commissioning, the second sensor module is detected as the slave. This configuration can be modified as desired. However, a modification must take place with the unit disconnected from the power supply.

The sensor modules have a designation independent of the master/slave configuration. This indicates where the sensor module is typically installed:

- Sensor module LP
LP = Low pressure; top
- Sensor module HP
HP = High pressure; bottom

For identical sensor module ranges, this assignment can likewise be changed, but this then has to be configured in the menu.

i If you change both sensor modules or the electronics, this allocation must likewise be carried out. See "Connect transm. (286)" parameter .

3.3 Registered trademarks

3.3.1 HART®

Registered trademark of the HART Communication Foundation, Austin, USA

4 Incoming acceptance and product identification

4.1 Incoming acceptance

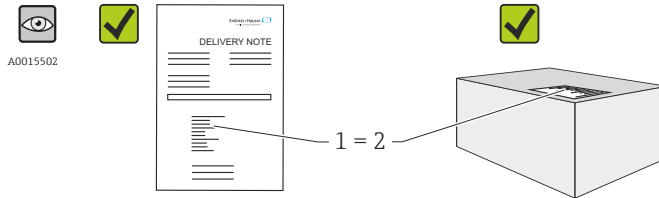

Is the order code on the delivery note (1) identical to the order code on the product sticker (2)?

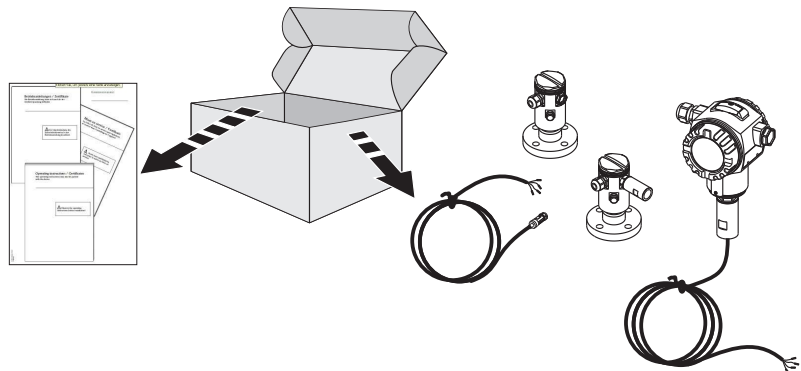

A0016052

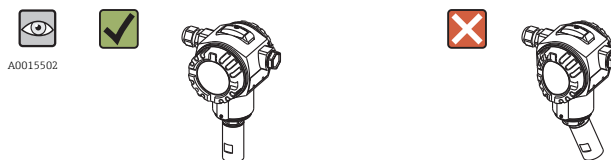

A0015502

A0016053

Are the goods undamaged?

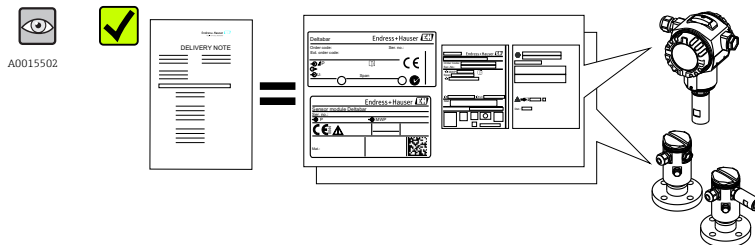

A0015502

A0016054

Do the data on the nameplate correspond to the order specifications and the delivery note?

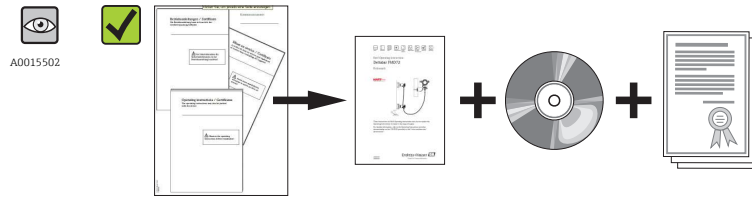

Are the CD-ROM (product documentation) and documentation present?
 If required (see nameplate): Are the safety instructions (XA) present?

i If one of these conditions is not met, please contact your Endress+Hauser sales office.

4.2 Product identification

The following options are available for identification of the measuring device:

- Nameplate specifications
- Order code with breakdown of the device features on the delivery note
- Enter serial numbers from nameplates in *W@M Device Viewer* (www.endress.com/deviceviewer): All information about the measuring device is displayed.

For an overview of the technical documentation provided, enter the serial number from the nameplates in the *W@M Device Viewer* (www.endress.com/deviceviewer)

4.3 Nameplates

4.3.1 Nameplates of the T14 transmitter housing

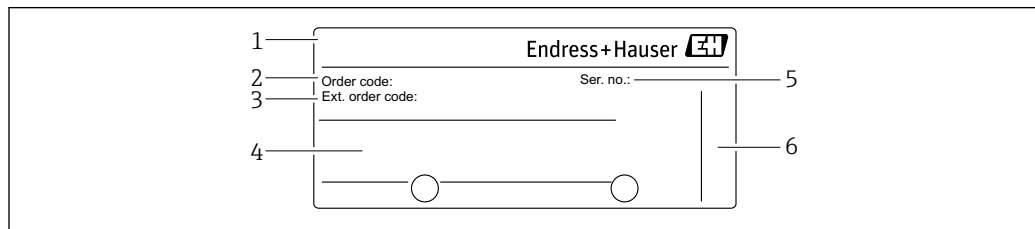

- 1 Device name
- 2 Order number (shortened for re-ordering)
- 3 Extended order number (complete)
- 4 Technical data
- 5 Serial number (for clear identification)
- 6 Manufacturer's address

Additional nameplate for devices with Ex approval

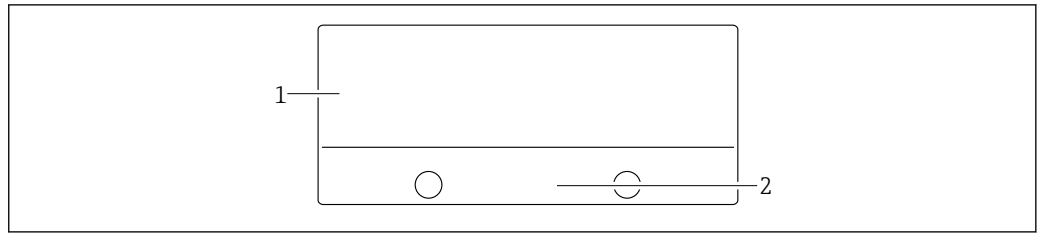

A0021222

- 1 Approval-specific information
- 2 Document number of Safety Instructions or drawing number

Additional nameplate for devices with PVDF process connection

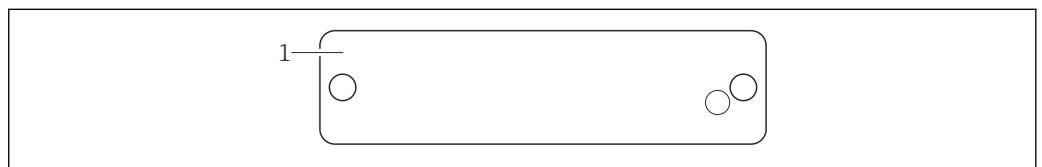

A0022683

- 1 Application limits

4.3.2 Nameplates of the T17 transmitter housing

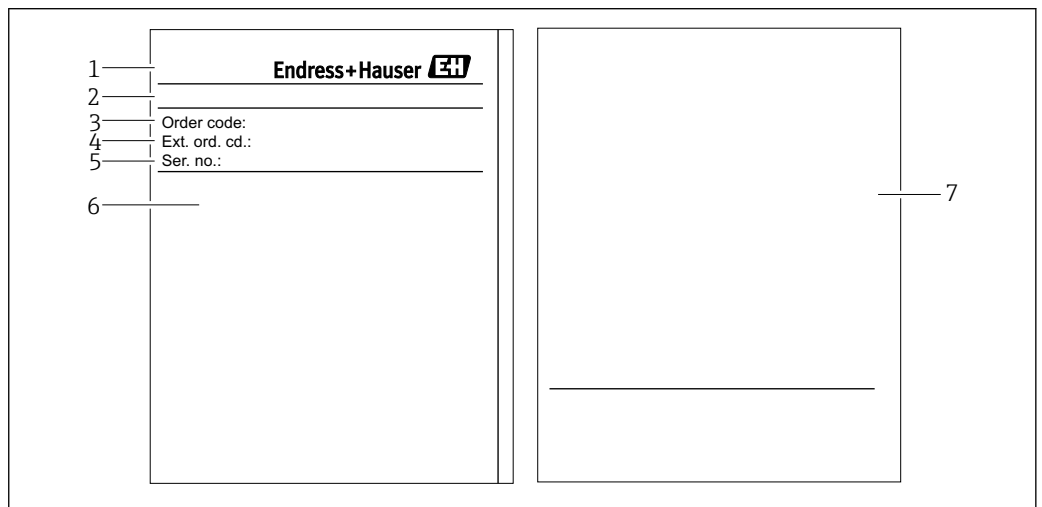

A0021552

- 1 Device name
- 2 Manufacturer's address
- 3 Order number (shortened for re-ordering)
- 4 Extended order number (complete)
- 5 Serial number (for clear identification)
- 6 Technical data
- 7 Approval-related information and document number of Safety Instructions or drawing number

4.3.3 Nameplate of the sensor housing

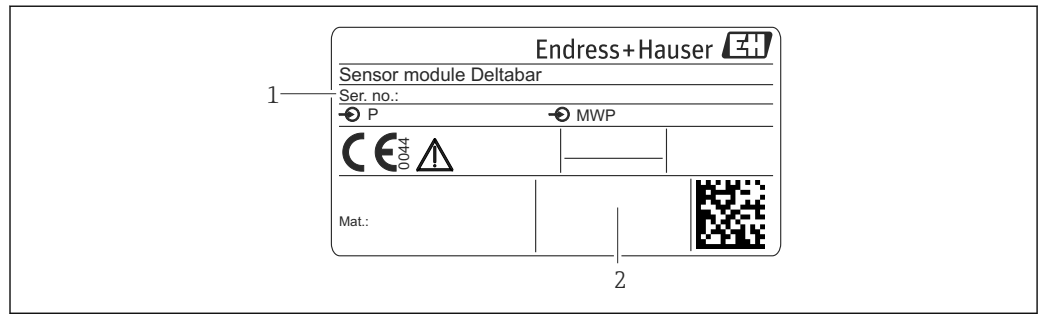

A0021224

- 1 Sensor serial number
- 2 Identification of sensor type (HP/LP)

5 Storage and transport

5.1 Storage conditions

Use original packaging.

5.1.1 Storage temperature range

-40 to +80 °C (-40 to +176 °F)

5.2 Transporting the product to the measuring point

⚠ WARNING

Risk of damage to housing!

Risk of injury.

- ▶ Transport the measuring device to the measuring point in its original packaging or by the process connection.
- ▶ Follow the safety instructions and transport conditions for devices weighing more than 18 kg (39.6 lbs).

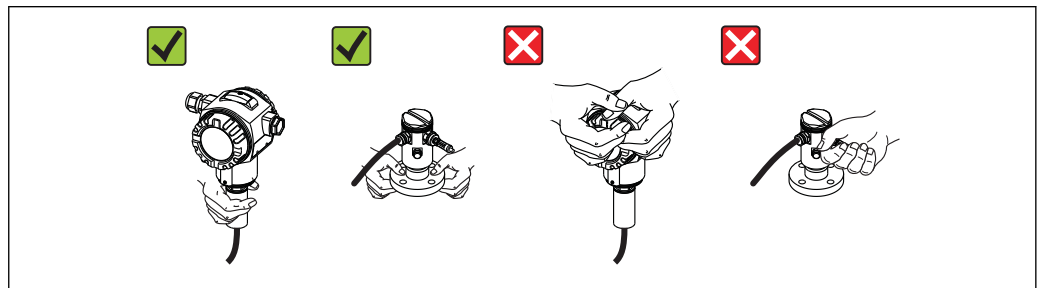

A0016058

6 Installation

When measuring in media containing solids, such as dirty liquids, installing separators and drain valves is useful for capturing and removing sediment.

6.1 Mounting dimensions

For dimensions, see the "Mechanical construction" section in TI01033P.

6.2 Mounting location

The FMD71/FMD72 is best suited to level measurement in vessels with pressure overlay or vacuum tanks, high distillation columns and other vessels with changing ambient temperatures.

The sensor module HP is mounted on the lower measuring connection and the sensor module LP is mounted above the maximum level. The transmitter can be mounted on pipes or walls with the mounting bracket.

6.3 Orientation

- Transmitter: Any orientation.
- Sensor modules: The orientation can cause a zero point shift .
This position-dependent zero point shift can be corrected directly at the device via the operating key, and also in hazardous areas in the case of devices with external operation (position adjustment).

6.4 General installation instructions

Mounting the sensor modules and transmitter is very easy

- The housings of the sensor modules can be rotated up to 480°.
- The transmitter is freely rotatable in the mounting bracket.

The sensor modules and transmitter can be easily aligned when mounted.

Your benefits

- Easy mounting due to optimum alignment of housing
- Easily accessible device operation
- Optimum readability of the onsite display (optional)
- Easy pipe installation due to optional alignment of the modules.

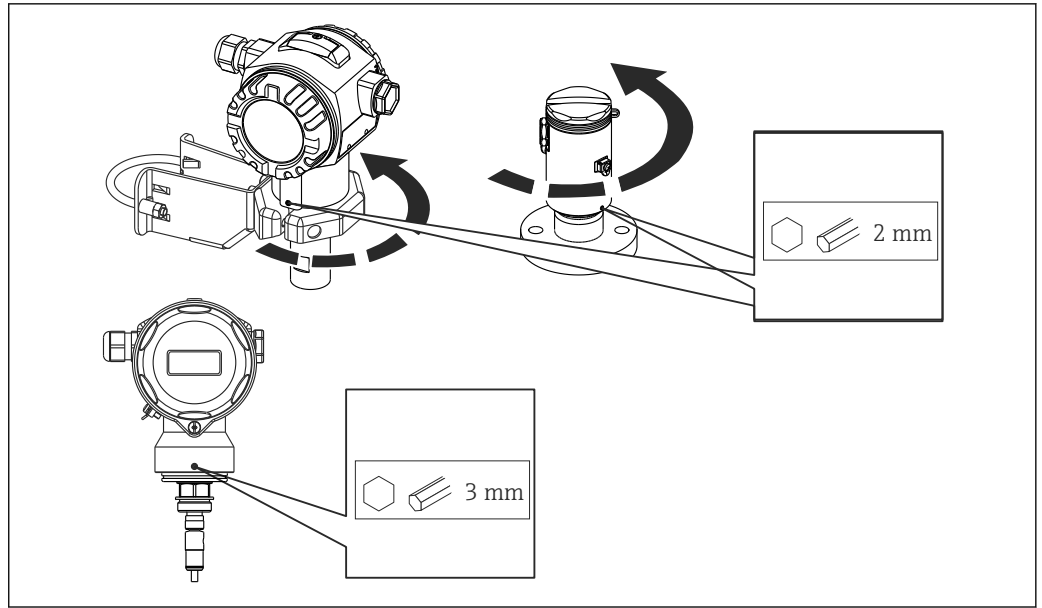

A0017506

6.5 Thermal insulation - FMD71 high-temperature version

The FMD71 high-temperature version may only be insulated up to a certain height. The maximum permitted insulation height is indicated on the devices and applies to an insulation material with a heat conductivity $\leq 0.04 \text{ W}/(\text{m} \times \text{K})$ and to the maximum permitted ambient and process temperature. The insulation height is not indicated on hygienic connections.

- Ambient temperature (T_A): $\leq 70 \text{ }^\circ\text{C}$ (158 $^\circ\text{F}$)
- Process temperature (T_P): $\leq 150 \text{ }^\circ\text{C}$ (302 $^\circ\text{F}$)

The data were determined under the most critical application "quiescent air".

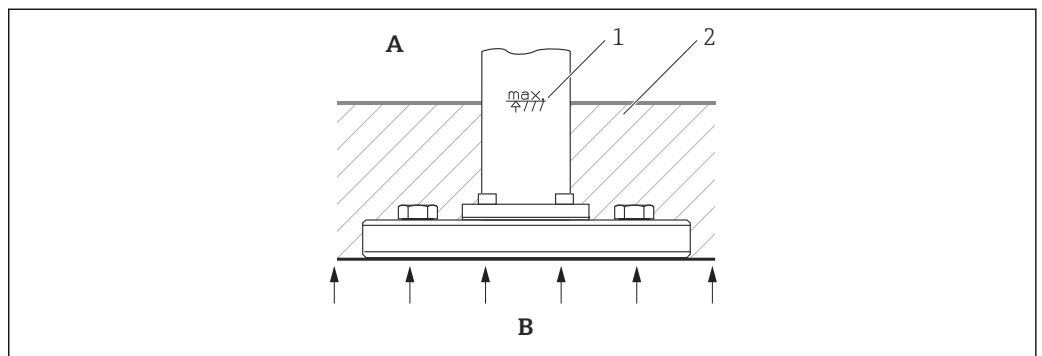

A0021075

- A Ambient temperature
- B Process temperature
- 1 Insulation height
- 2 Insulation material

6.6 Installing the sensor modules

6.6.1 General installation instructions

- The nameplate on the sensor module specifies where the sensor module is typically installed:
HP (bottom)
LP (top)
For further information, see the "Function" (→ [12](#)) section.
- Due to the orientation of the sensor modules, there may be a shift in the zero point, i.e. when the vessel is empty or partially full, the measured value does not display zero. You can correct this zero point shift: see "Commissioning without an operating menu" (→ [42](#)) or the "Position adjustment" section (→ [47](#)).
- Always install the sensor module HP below the lowest measuring point.
- Always install the sensor module LP above the highest measuring point.
- Do not mount the sensor modules in the filling curtain or at a point in the tank which could be affected by pressure pulses from an agitator.
- Do not mount the sensor modules in the suction area of a pump.
- The adjustment and functional test can be carried out more easily if you mount the sensor modules downstream of a shutoff device.
- If a heated sensor module is cooled during the cleaning process (e.g. by cold water), a vacuum develops for a short time, whereby moisture can penetrate the sensor through the pressure compensation (3). If this is the case, mount the sensor with the pressure compensation (3) pointing downwards.
- Keep the pressure compensation and GORE-TEX® filter (3) free from contamination.
- Do not clean or touch process isolating diaphragms with hard or pointed objects.

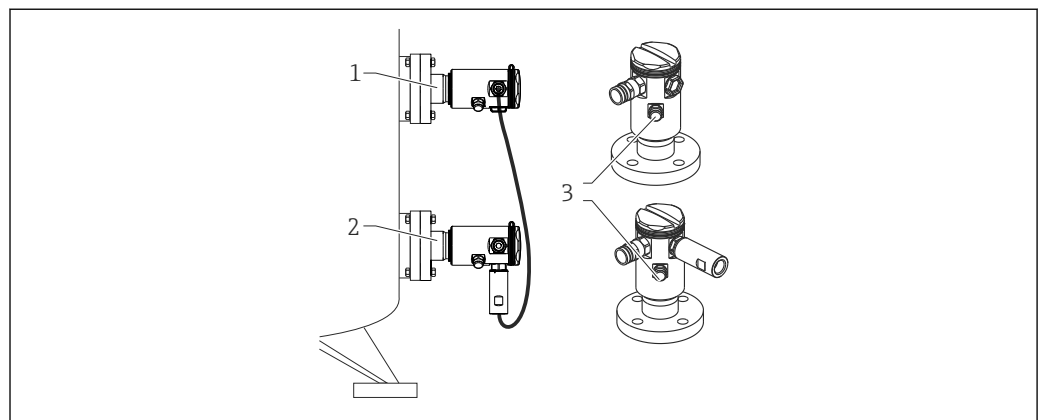

A0017512

6.6.2 Mounting sensor modules with PVDF process connections

⚠ WARNING

Risk of damage to process connection!

Risk of injury!

- ▶ Sensor modules with PVDF process connections must be installed with the mounting bracket supplied!

The mounting bracket can be installed on pipes with a diameter of 1¼" to 2" or on walls.

In the case of pipe mounting, the nuts on the bracket must be tightened uniformly with a torque of at least 5 Nm (3.69 lbf ft).

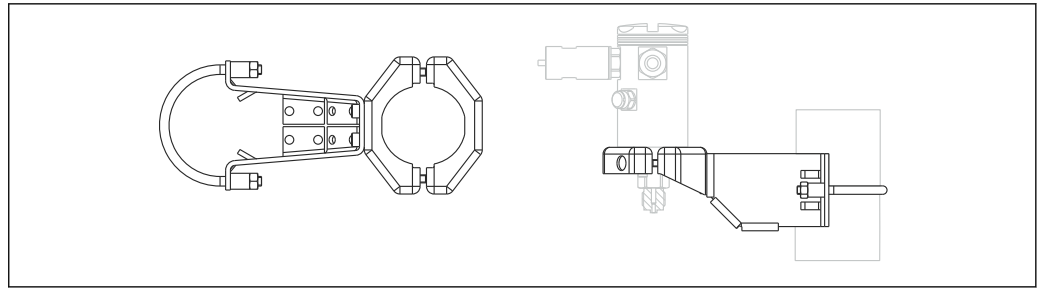

A0017514

6.7 Installing the transmitter

The transmitter is installed with the mounting bracket supplied. The mounting bracket can be installed on pipes with a diameter of 1¼" to 2" or on walls.

In the case of pipe mounting, the nuts on the bracket must be tightened uniformly with a torque of at least 5 Nm (3.69 lbf ft).

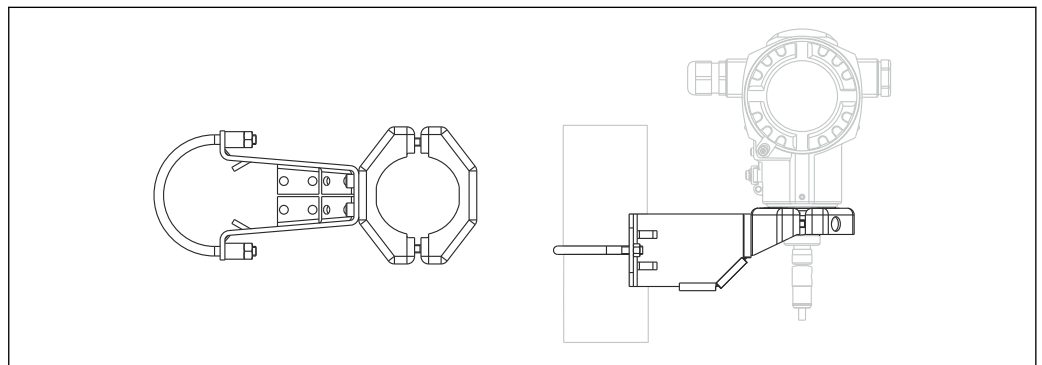

A0021145

6.7.1 Turning the display module

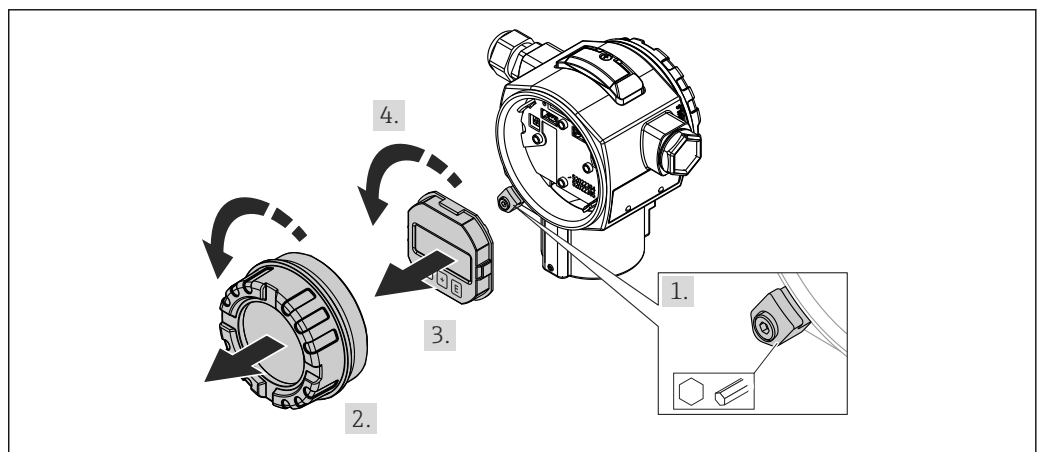

A0017524

⚠ WARNING

Supply voltage switched off?

Risk of electric shock and/or explosion!

- ▶ Switch off the supply voltage before connecting the device.

1. If present (i.e. in devices with Ex d and Ex na approval), release the securing clamp of the electronics compartment cover with an Allen key.

2. Unscrew the electronics compartment cover from the transmitter housing.
3. Pull out the display module with a gentle rotational movement.
4. Rotate the display module into the desired position: max. $4 \times 90^\circ$ in each direction.
5. Fit the display module on the electronics compartment in the desired position until it clicks into place.
6. Screw the electronics compartment cover back onto the transmitter housing.
7. If present (i.e. in devices with Ex d and Ex na approval), tighten the securing clamp with an Allen key (1 Nm (0.225 lbf)).

6.8 Closing the housing covers

⚠ CAUTION

The housing cover can no longer be closed.

Damaged thread!

- ▶ When closing the housing covers make sure that the threads on the covers and the housing are free from dirt, such as sand. If you encounter resistance when closing the covers, then check the threads again for dirt or fouling.

6.8.1 Closing the covers on the hygienic stainless steel housing (T17)

The covers for the terminal compartment and electronics compartment are hooked into the housing and closed with a screw in each case. These screws must be tightened finger-tight (2 Nm (1.48 lbf ft)) to the stop to ensure that the covers are securely seated and leak-tight.

6.9 Seal for flange mounting

NOTICE

Distorted measurement results.

The seal is not allowed to press against the process isolating diaphragm as this could affect the measurement result.

- ▶ Ensure that the seal is not touching the process isolating diaphragm.

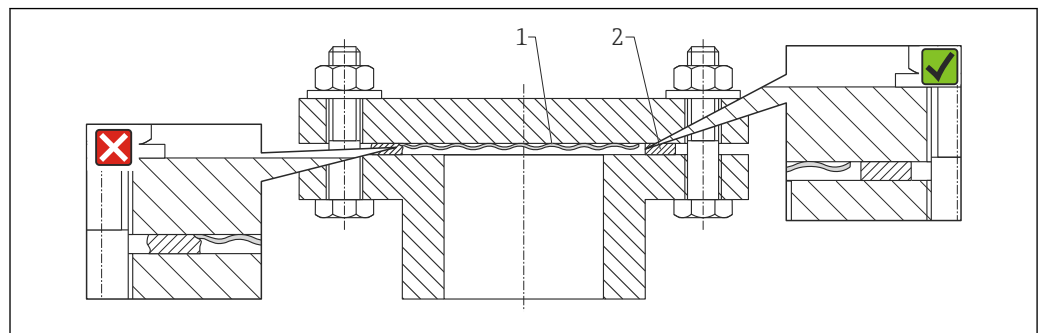

A0017743

- 1 Process isolating diaphragm
- 2 Seal

6.10 Post-installation check

<input type="radio"/>	Is the device undamaged (visual inspection)?
<input type="radio"/>	Does the device conform to the measuring point specifications? For example: <ul style="list-style-type: none">▪ Process temperature▪ Process pressure▪ Ambient temperature▪ Measuring range
<input type="radio"/>	Are the measuring point identification and labeling correct (visual inspection)?
<input type="radio"/>	Is the device adequately protected from precipitation and direct sunlight?
<input type="radio"/>	Are the securing screw and securing clamp tightened securely?

7 Electrical connection

⚠ WARNING

If the operating voltage is > 35 VDC: Dangerous contact voltage at terminals.
Risk of electric shock!

- ▶ In a wet environment, do not open the cover if voltage is present.

i The sensor modules have a designation independent of the master/slave configuration. This indicates where the sensor module is typically installed:

- Sensor module LP
LP = Low pressure; top
- Sensor module HP
HP = High pressure; bottom

For further information, see the "Function" (→  12) section.

7.1 Connecting the sensor module LP to the sensor module HP

⚠ WARNING

Supply voltage might be connected!
Risk of electric shock and/or explosion!

- ▶ Switch off the supply voltage before connecting the device.
- Screw on the housing cover of the terminal compartment of the sensor module LP.
- Guide the cable of the sensor module HP through the cable gland of the sensor module LP. Use the shielded 4-wire cable that is provided. The wire ends are color-coded to match the corresponding terminal.
- Connect device in accordance with the following diagrams.
- Screw down housing cover.

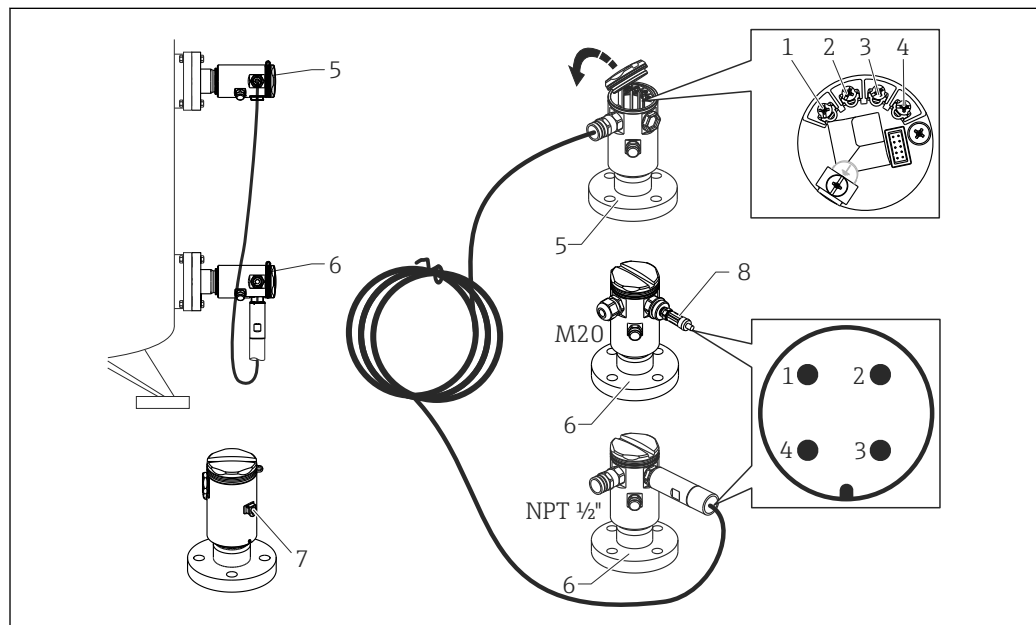

A0017528

- 1 BK (black)
- 2 BU (blue)
- 3 WH (white)
- 4 BN (brown)
- 5 Sensor module LP
- 6 Sensor module HP
- 7 Ground terminal
- 8 Torque 0.4 Nm

7.1.1 Screening with cable shield

Screening with cable shield is described in the associated documentation SD00354P. The documentation is provided with the connecting cables.

7.2 Connecting the sensor module HP to the transmitter

⚠ WARNING

Supply voltage might be connected!

Risk of electric shock and/or explosion!

► Switch off the supply voltage before connecting the device.

- Screw on the housing cover of the terminal compartment of the sensor module HP.
- Guide the cable of the transmitter through the cable gland of the sensor module HP. Use the shielded 4-wire cable that is provided. The wire ends are color-coded to match the corresponding terminal.
- Connect device in accordance with the following diagram.
- Screw down housing cover.

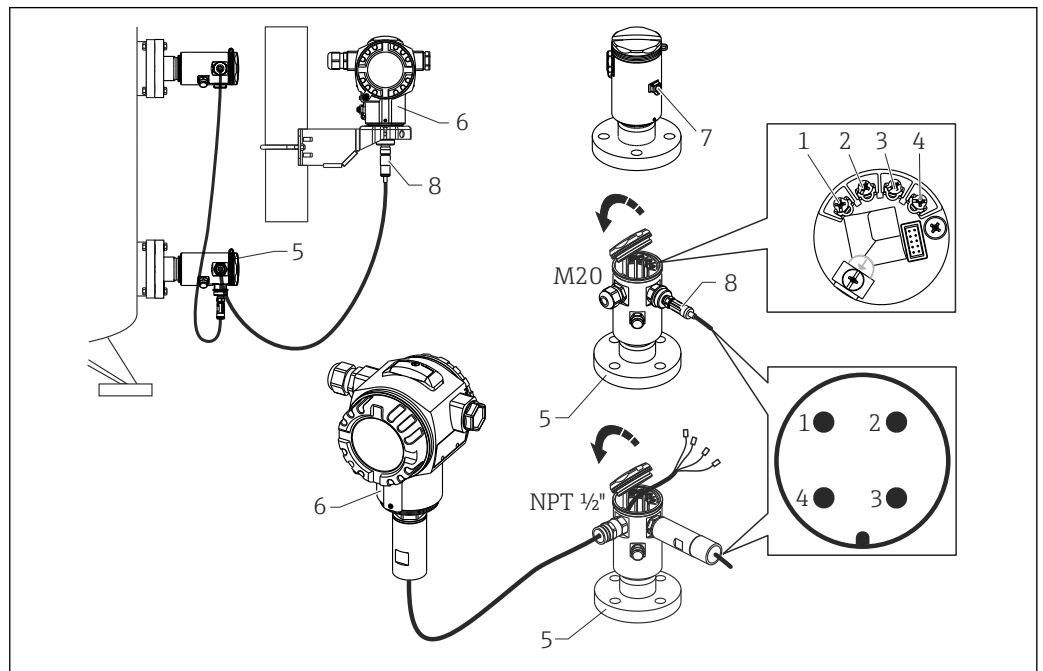

A0017529

- 1 BK (black)
- 2 BU (blue)
- 3 WH (white)
- 4 BN (brown)
- 5 Sensor module HP
- 6 Transmitter
- 7 Ground terminal
- 8 Torque 0.4 Nm

7.2.1 Screening with cable shield

Screening with cable shield is described in the associated documentation SD00354P. The documentation is provided with the connecting cables.

7.3 Connecting the measuring unit

7.3.1 Terminal assignment

⚠ WARNING

Supply voltage might be connected!

Risk of electric shock and/or explosion!

- ▶ Switch off the supply voltage before connecting the device.

NOTICE

Limitation of electrical safety due to incorrect connection!

- ▶ When using the measuring device in hazardous areas, installation must comply with the corresponding national standards and regulations and the Safety Instructions or Installation or Control Drawings.
- ▶ All explosion protection data are given in separate documentation which is available upon request. The Ex documentation is supplied as standard with all devices approved for use in explosion hazardous areas.
- ▶ Devices with integrated overvoltage protection must be grounded.
- ▶ Protective circuits against reverse polarity, HF influences and overvoltage peaks are integrated.
- ▶ The supply voltage must match the power supply specified on the nameplate (see "Nameplate" (→ 14))
- ▶ Switch off the supply voltage before connecting the device.
- ▶ Remove the housing cover of the terminal compartment.
- ▶ Guide cable through the gland. Preferably use twisted, screened two-wire cable.
- ▶ Connect device in accordance with the following diagram.
- ▶ Screw down housing cover.
- ▶ Switch on supply voltage.

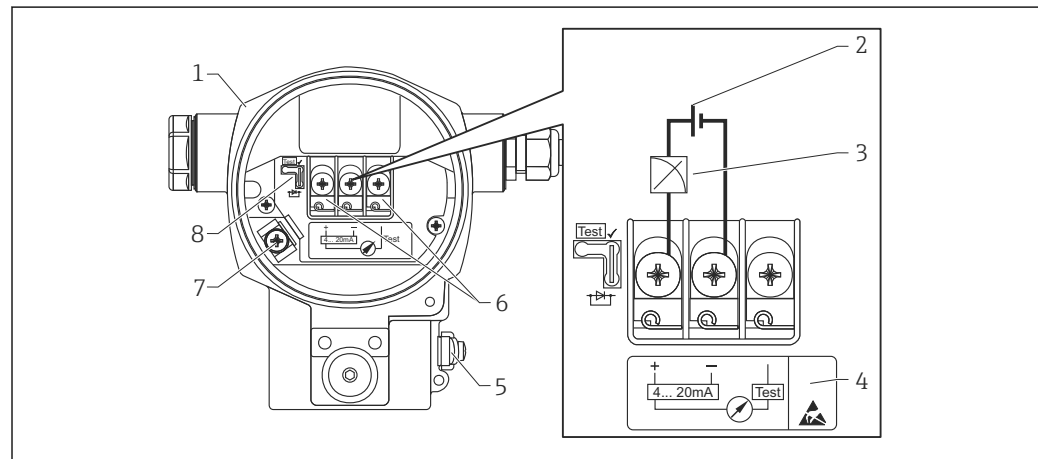

A0019989

- 1 Housing
- 2 Supply voltage
- 3 4 to 20 mA
- 4 Devices with integrated overvoltage protection are labeled "OVP" (overvoltage protection) here.
- 5 External ground terminal
- 6 4 to 20 mA test signal between positive and test terminal
- 7 Internal ground terminal, minimum supply voltage = 12 V DC, jumper is set as illustrated in the diagram.
- 8 Jumper for 4 to 20 mA test signal

7.3.2 Supply voltage

⚠ WARNING

Supply voltage might be connected!

Risk of electric shock and/or explosion!

- ▶ When using the measuring device in hazardous areas, installation must comply with the corresponding national standards and regulations as well as the Safety Instructions.
- ▶ All explosion protection data are given in separate documentation which is available upon request. The Ex documentation is supplied as standard with all devices approved for use in explosion hazardous areas.

Electronic version	Jumper for 4 to 20 mA test signal in "Test" position (delivery status)	Jumper for 4 to 20 mA test signal in "Non-test" position
4 to 20 mA HART, version for non-hazardous areas	13 to 45 V DC	12 to 45 V DC

Measuring a 4 to 20 mA test signal

A 4 to 20 mA test signal may be measured via the positive and test terminal without interrupting the measurement. The minimum supply voltage of the device can be reduced by simply changing the position of the jumper. As a result, operation is also possible with a lower supply voltage. To keep the corresponding measured error below 0.1 %, the current measuring device should exhibit an internal resistance of <0.7Ω. Observe the position of the jumper in accordance with the following table.

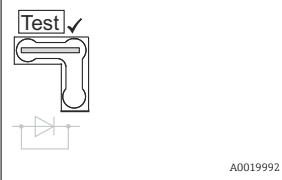
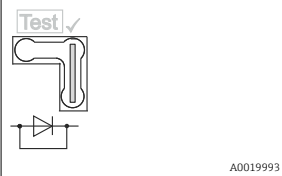
Jumper position for test signal	Description
	<ul style="list-style-type: none"> ▪ Measurement of 4 to 20 mA test signal via the positive and test terminal: possible. (Thus, the output current can be measured without interruption via the diode.) ▪ Delivery status ▪ Minimum supply voltage: 13 V DC
	<ul style="list-style-type: none"> ▪ Measurement of 4 to 20 mA test signal via positive and test terminal: not possible. ▪ Minimum supply voltage: 12 V DC

7.4 Connection conditions

7.4.1 Cable specification for transmitter connection

- Endress+Hauser recommends using twisted, shielded two-wire cables.
- Terminals for core cross-sections 0.5 to 2.5 mm² (20 to 14 AWG)
- The cable outer diameter depends on the cable entry used.

7.4.2 Cable glands

Explosion protection	Cable gland	Permitted cable diameter	Permitted wire cross-sections
<ul style="list-style-type: none"> ▪ Standard ▪ Ex ia ▪ Ex ic 	Plastic M20x1.5	5 to 10 mm (0.2 to 0.39 in)	0.5 to 2.5 mm ² (20 to 14 AWG)
<ul style="list-style-type: none"> ▪ Ex tD ▪ Ex nA ▪ FM approval ▪ CSA approval 	Metal M20 x 1.5	7 to 10.5 mm (0.28 to 0.41 in)	

7.4.3 Overvoltage protection

Standard version

The standard version of the pressure instruments does not contain any special elements to protect against overvoltage ("wire to ground"). Nevertheless the requirements of the applicable EMC standard EN 61000-4-5 (testing voltage 1kV EMC wire/ground) are met.

Optional overvoltage protection

Devices showing version "NA" in feature 610 "Accessory Mounted" in the order code are equipped with overvoltage protection.

- Overvoltage protection:
 - Nominal functioning DC voltage: 600 V
 - Nominal discharge current: 10 kA
- Surge current check $\hat{i} = 20$ kA satisfied as per DIN EN 60079-14: 8/20 μ s
- Arrester AC current check $I = 10$ A satisfied

NOTICE

Device could be destroyed!

- ▶ Devices with integrated overvoltage protection must be grounded.

7.5 Connection data

7.5.1 Maximum load

In order to guarantee sufficient terminal voltage in two-wire devices, a maximum load resistance R (including line resistance) must not be exceeded depending on the supply voltage U_0 of the supply unit.

In the following load diagrams, observe the position of the jumper and the explosion protection:

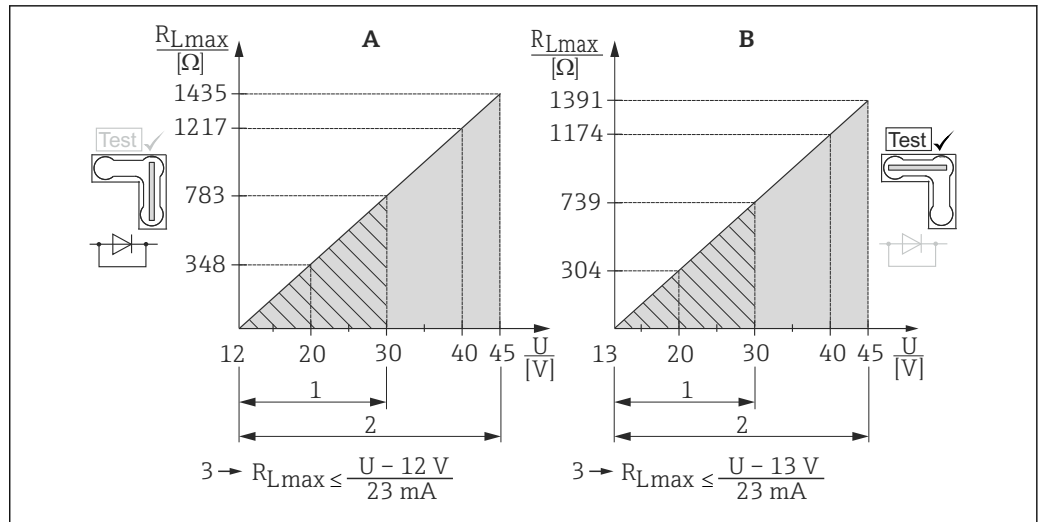

A0017533

A Jumper for 4 to 20 mA test signal set to "Non-test" position

B Jumper for 4 to 20 mA test signal set to "Test" position

1 Power supply for II 1/2 G Ex ia, FM IS, CSA IS

2 Power supply for devices for the non-hazardous area, 2 G Ex d, 3 G Ex nA, FM XP, FM NI, CSA XP, CSA dust ignition-proof

3 R_{Lmax} maximum load resistance

U Supply voltage

7.5.2 Shielding

- You achieve optimum shielding against disturbances if the shielding is connected on both sides (in the cabinet and on the device). If potential equalization currents are expected in the plant, only ground shielding on one side, preferably at the transmitter.
- When using in hazardous areas, you must observe the applicable regulations. Separate Ex documentation with additional technical data and instructions is included with all Ex systems as standard.

7.6 Post-connection check

<input type="radio"/>	Is the device or cable undamaged (visual check)?
<input type="radio"/>	Do the cables comply with the requirements ?
<input type="radio"/>	Do the cables have adequate strain relief?
<input type="radio"/>	Are all the cable glands installed, firmly tightened and leak-tight?
<input type="radio"/>	Does the supply voltage match the specifications on the nameplate?
<input type="radio"/>	Is the terminal assignment correct ?
<input type="radio"/>	If required: Has protective ground connection been established ?
<input type="radio"/>	If supply voltage is present, is the device ready for operation and do values appear on the display module?
<input type="radio"/>	Are all housing covers installed and firmly tightened?
<input type="radio"/>	Is the securing clamp tightened correctly?

8 Operation without an operating menu

8.1 Position of operating elements

8.1.1 Operating keys on the exterior of the device

With the T14 housing (aluminum or stainless steel), the operating keys are located either outside of the housing, under the protection cap or inside on the electronic insert. In addition, devices with an onsite display and a 4 to 20 mA HART electronic insert have operating keys on the onsite display.

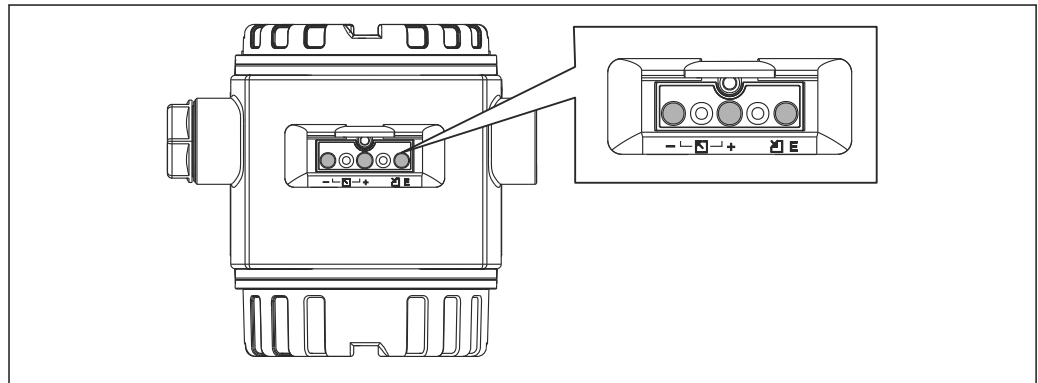

A0016499

The operating keys on the outside of the device make it unnecessary to open the housing. This guarantees:

- Complete protection against environmental influences such as moisture and contamination.
- Simple operation without any tools.
- No wear.

8.1.2 Operating keys and elements located internally on the electronic insert

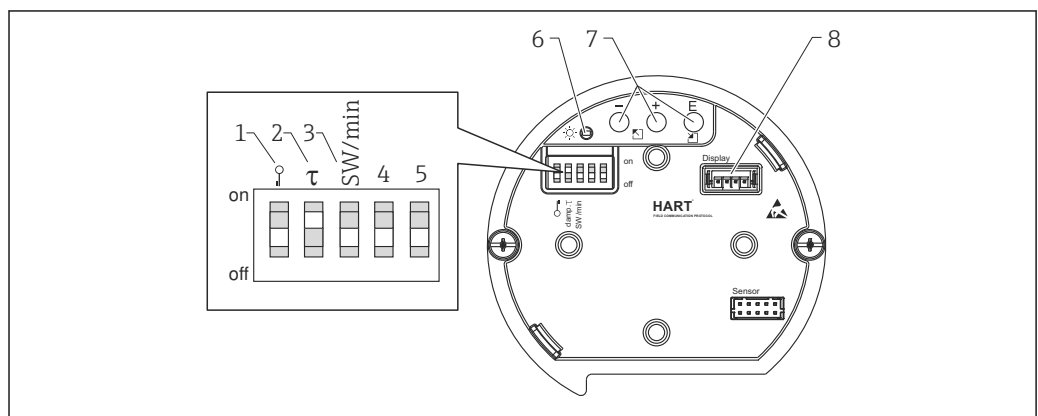

A0016500







- 1 DIP switch for locking/unlocking parameters relevant to the measured value
- 2 DIP switch for switching damping on/off
- 3 DIP switch for alarm current SW/Alarm min (3.6 mA)
- 4...5 Not assigned
- 6 Green LED to indicate value being accepted
- 7 Operating keys
- 8 Slot for optional display

8.1.3 Function of the DIP switches

Switch	Symbol/ labeling	Switch position	
		"off"	"on"
1	 A0011978	The device is unlocked. Parameters relevant to the measured value can be modified.	The device is locked. Parameters relevant to the measured value cannot be modified.
2	damping τ	Damping is switched off. The output signal follows measured value changes without any delay.	Damping is switched on. The output signal follows measured value changes with the delay time τ . ¹⁾
3	SW/Alarm min	The alarm current is defined via the configuration in the operating menu. ("Setup" → "Extended Setup" → "Current Output" → "Output Fail Mode") ²⁾	The alarm current is 3.6 mA (min), regardless of the setting in the operating menu.

- 1) The value for the delay time can be configured via the operating menu ("Setup" → "Damping"). Factory setting: $\tau = 2$ s or as per order specifications.
- 2) Factory setting: 22 mA

8.1.4 Function of the operating elements

	Operating key(s)	Meaning
 A0017535	Press for at least 3 seconds	Adopt lower range value. A reference pressure is present at the device. For a detailed description, see also "Pressure measuring mode" section, (→ 42), or "Level measuring mode" section (→ 43).
 A0017536	Press for at least 3 seconds	Adopt upper range value. A reference pressure is present at the device. For a detailed description, see also "Pressure measuring mode" section, (→ 42), or "Level measuring mode" section (→ 43).
 A0017537	Press for at least 3 seconds	Position adjustment
 and  and  A0017535 A0017536 A0017537	Press for at least 6 seconds	Reset all parameters. The reset via operating keys corresponds to the software reset code 7864.

9 Operation with an operating menu

9.1 Operating concept

Operation with an operating menu is based on an operation concept with "user roles".

User role	Meaning
Operator	Operators are responsible for the devices during normal "operation". This is usually limited to reading process values either directly at the device or in a control room. If the work with the devices goes beyond reading, it concerns simple, application-specific functions that are used in operation. Should an error occur, these users simply forward the information on the errors but do not intervene themselves.
Maintenance	Service engineers usually work with the devices in the phases following device commissioning. They are primarily involved in maintenance and troubleshooting activities for which simple settings have to be made at the device. Technicians work with the devices over the entire life cycle of the product. Thus, commissioning and advanced settings and configurations are some of the tasks they have to carry out.
Expert	Experts work with the devices over the entire life cycle of the device, but, in part, have high requirements on the devices. Individual parameters/functions from the overall functionality of the devices are required for this purpose time and again. In addition to technical, process-oriented tasks, experts can also perform administrative tasks (e.g. user administration). "Experts" can avail of the entire parameter set.

9.2 Structure of the operating menu

User role	Submenu	Meaning/use
Operator	Language	Only consists of the "Language" parameter (000) where the operating language for the device is specified. The language can always be changed even if the device is locked.
	Display/ operat.	Contains parameters that are needed to configure the measured value display (selecting the values displayed, display format, etc.). With this submenu, users can change the measured value display without affecting the actual measurement.
Maintenance	Setup	<p>Contains all the parameters that are needed to commission measuring operations. This submenu has the following structure:</p> <ul style="list-style-type: none"> ▪ Standard setup parameters A wide range of parameters, which can be used to configure a typical application, is available at the start. The measuring mode selected determines which parameters are available. After making settings for all these parameters, the measuring operation should be completely configured in the majority of cases. ▪ "Extended Setup" submenu The "Extended Setup" submenu contains additional parameters for more in-depth configuration of the measurement operation to convert the measured value and to scale the output signal. This menu is split into additional submenus depending on the measuring mode selected.

User role	Submenu	Meaning/use
	Diagnostics	<p>Contains all the parameters that are needed to detect and analyze operating errors. This submenu has the following structure:</p> <ul style="list-style-type: none"> ▪ Diagnostic list Contains up to 10 currently pending error messages. ▪ Event logbook Contains the last 10 error messages (no longer pending). ▪ Instrument info Contains information for identifying the device. ▪ Measured values Contains all current measured values. ▪ Simulation Is used to simulate pressure, level, flow, current and alarm/warning. ▪ Reset ▪ Sensor LP ▪ Sensor HP
Expert	Expert	<p>Contains all the parameters of the device (including those already in one of the submenus). The "Expert" submenu is structured by the function blocks of the device. It thus contains the following submenus:</p> <ul style="list-style-type: none"> ▪ System Contains all device parameters that neither affect measurement nor integration into a distributed control system. ▪ Measurement Contains all parameters for configuring the measurement. ▪ Output Contains all parameters for configuring the current output. ▪ Communication Contains all parameters for configuring the HART interface. ▪ Diagnostics Contains all the parameters that are needed to detect and analyze operating errors.

9.3 Operating options

9.3.1 Local operation

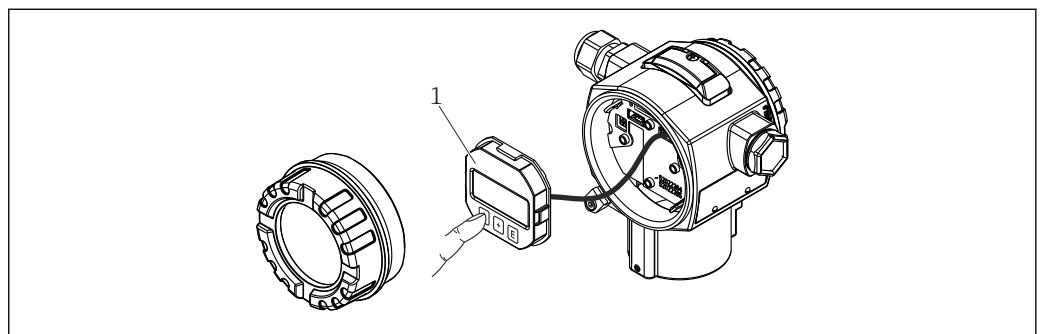

1 Display and operating module with push buttons. Cover must be opened for operation.

9.4 Operating the device using onsite display (optional)

A 4-line liquid crystal display (LCD) is used for display and operation. The onsite display shows measured values, dialog text as well as fault and notice messages in plain text, thereby supporting the user in every stage of operation. The device display can be turned in 90° steps. Depending on the installation position of the device, this makes it easy to operate the device and read the measured value.

Functions:

- 8-digit measured value display incl. sign and decimal point, bargraph for 4 to 20 mA HART as current display.
- Simple and complete menu guidance thanks to separation of the parameters into several levels.
- Each parameter is given a 3-digit ID number for easy navigation.
- Option for configuring the display according to individual requirements and preferences, such as language, alternating display, display of other measured values such as sensor temperature, contrast setting.
- Comprehensive diagnostic functions (fault and warning message, peak-hold indicators, etc.).
- Quick and safe commissioning

9.4.1 Setting the contrast on the display module

- \oplus and \boxplus (press simultaneously): increases the contrast.
- \ominus and \boxminus (press simultaneously): decreases the contrast.

9.4.2 Overview

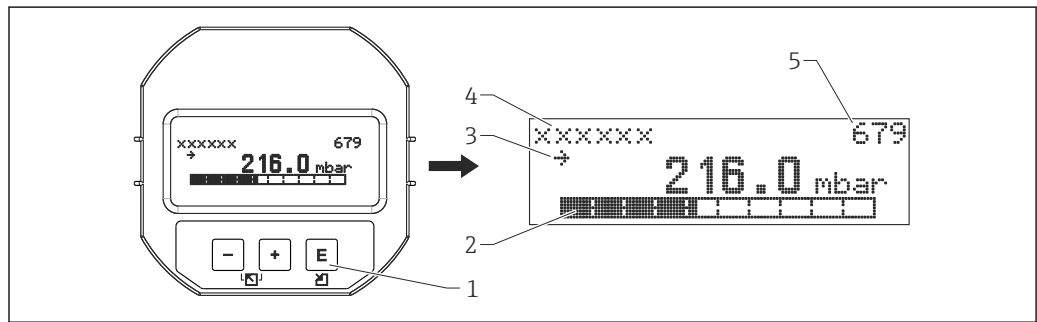

A0016498

- 1 Operating keys
- 2 Bargraph
- 3 Symbol
- 4 Header
- 5 Parameter ID number

9.4.3 Symbols on the onsite display

Error symbols

Symbol	Meaning
S A0012088	Error message "Out of specification" The device is being operated outside its technical specifications (e.g. during warm-up or cleaning processes).
C A0012100	Error message "Service mode" The device is in service mode (e.g. during a simulation).
M A0012101	Error message "Maintenance required" Maintenance is required. The measured value remains valid.
F A0012086	Error message "Failure detected" An operating error has occurred. The measured value is no longer valid.

Display symbols for locking status









Symbol	Meaning
	Lock symbol The operation of the device is locked. To unlock device, see section on "Unlocking/locking configuration" (→ 42).

Display symbols for communication

Symbol	Meaning
	Communication symbol Data transfer via communication





9.4.4 Navigation and selection from list

The operating keys are used to navigate through the operating menu and to select an option from a picklist.

Operating key(s)	Meaning
	<ul style="list-style-type: none"> ▪ Navigate downwards in the picklist ▪ Edit the numerical values and characters within a function
	<ul style="list-style-type: none"> ▪ Navigate upwards in the picklist ▪ Edit the numerical values and characters within a function
	<ul style="list-style-type: none"> ▪ Confirm entry ▪ Jump to the next item ▪ Selection of a menu item and activation of edit mode
 and 	Contrast setting of onsite display: darker
	Contrast setting of onsite display: brighter
 and 	ESC functions: <ul style="list-style-type: none"> ▪ Exit edit mode for a parameter without saving the changed value. ▪ You are in a menu at a selection level. Each time you press the keys simultaneously, you go up a level in the menu.

9.4.5 Navigation examples

Parameters with a picklist

	Language	000	Operation
1	<input checked="" type="checkbox"/> German <input type="checkbox"/> Spanish		"English" is set as the menu language (default value). A <input checked="" type="checkbox"/> in front of the menu text indicates the active option.
2	<input type="checkbox"/> German <input checked="" type="checkbox"/> Spanish		Select the menu language "Spanish" using  or  .
3	<input checked="" type="checkbox"/> Spanish <input type="checkbox"/> German		Confirm your choice with  . A <input checked="" type="checkbox"/> in front of the menu text indicates the active option ("Spanish" is the language selected). Exit edit mode for the parameter with  .

Accepting the pressure present

Example: setting position adjustment.

Menu path: Main menu → Setup → Pos. Zero Adjust

	Pos. Zero Adjust 007	Operation
1	<input checked="" type="checkbox"/> Cancel Confirm	The pressure for position adjustment is present at the device.
2	Cancel <input checked="" type="checkbox"/> Confirm	Use <input type="checkbox"/> or <input type="checkbox"/> to switch to the "Confirm" option. The active option is highlighted in black.
3	Adjustment has been accepted!	Accept the applied pressure as a position adjustment with the <input type="checkbox"/> key. The device confirms the adjustment and goes back to the "Pos. zero adjust" parameter.
4	<input checked="" type="checkbox"/> Cancel Confirm	Exit edit mode for the parameter with <input type="checkbox"/> .

User-definable parameters

Example: setting parameter "Set URV (014)" from 100 mbar (1.5 psi) to 50 mbar (0.75 psi).

Menu path: Setup → Advanced. Setup → Current output → Set URV

	Set URV 014	Operation
1	<input type="text" value="1 0 0 . 0 0 0"/> mbar	The onsite display shows the parameter to be changed. The "mbar" unit is defined in another parameter and cannot be changed here.
2	<input type="text" value="1 0 0 . 0 0 0"/> mbar	Press <input type="checkbox"/> or <input type="checkbox"/> to get to edit mode. The first digit is highlighted in black.
3	<input type="text" value="5 0 0 . 0 0 0"/> mbar	Use the <input type="checkbox"/> key to change "1" to "5". Press the <input type="checkbox"/> key to confirm "5". Cursor jumps to the next position. Use the <input type="checkbox"/> key to confirm (second position).
4	<input type="text" value="5 0 0 . 0 0 0"/> mbar	The third digit is highlighted in black and can now be edited.
5	<input type="text" value="5 0 . 0 0 0"/> mbar	Use the <input type="checkbox"/> key to change to the "." symbol. Use <input type="checkbox"/> to save the new value and exit edit mode. See next graphic.
6	<input type="text" value="5 0 . 0 0 0"/> mbar	The new value for the full scale value is 50.0 mbar (0.75 psi). Exit edit mode for the parameter with <input type="checkbox"/> . You can get back to edit mode with <input type="checkbox"/> or <input type="checkbox"/> .

9.5 Operation using Endress+Hauser operating program

The FieldCare operating program is an Endress+Hauser plant asset management tool based on FDT technology. With FieldCare, you can configure all Endress+Hauser devices as well as devices from other manufacturers that support the FDT standard.

Hardware and software requirements can be found on the Internet:

www.de.endress.com → Search: FieldCare → FieldCare → Technical data.



FieldCare supports the following functions:

- Configuration of transmitters in online/offline mode
- Loading and saving device data (upload/download)
- Documentation of the measuring point

9.6 Direct access to parameters

The parameters can only be accessed directly via the "Expert" user role.

Direct access (119)

Navigation	  Expert → Direct Access
Read permission	Operators/Service engineers/Expert
Write permission	Operators/Service engineers/Expert
Description	Enter the direct access code to go directly to a parameter.
Options	Enter the desired parameter code.
Factory setting	0
Note	For direct access, it is not necessary to enter leading zeros.

9.7 Locking/unlocking operation

Once you have entered all the parameters, you can lock your entries against unauthorized and undesired access.

You have the following options for locking/unlocking operation:

- Via the DIP switch on the electronic insert, local at the device.
- Via the local display (optional)
- Via communication e.g. FieldCare and HART handheld terminal.



The  symbol on the local display indicates that operation is locked. Parameters which refer to how the display appears, e.g. "Language" and "Display contrast", can still be altered.

 If operation is locked by means of the DIP switch, you can only unlock operation again by means of the DIP switch. If operation is locked by means of local display or remote operation e.g. FieldCare, you can unlock operation either using the local display or remote operation.

The "Operator Code" parameter is used to lock and unlock the device.

The parameters can only be accessed directly via the "Expert" user role.

Operator Code (021)

Navigation	  Setup → Extended Setup → Operator Code
Read permission	Operators/Service engineers/Expert

Write permission	Operators/Service engineers/Expert
Description	Use this function to enter a code to lock or unlock operation.
User entry	<ul style="list-style-type: none"> ■ To lock: Enter a number ≠ the release code (value range: 1 to 9999). ■ To unlock: Enter the release code.
Factory setting	0
Note	<p>The release code is "0" in the order configuration. Another release code can be defined in the "Code Definition" parameter. If the user has forgotten the release code, the release code can be visible by entering the number "5864".</p> <p>The release code is defined in the "Code Definition" parameter.</p>

Code Definition (023)

Navigation	 Setup → Extended Setup → Code Definition
Read permission	Operators/Service engineers/Expert
Write permission	Operators/Service engineers/Expert
Description	Use this function to enter a release code with which the device can be unlocked.
User entry	A number from 0 to 9999
Factory setting	0

9.8 Resetting to factory settings (reset)

By entering a certain code, you can completely, or partially, reset the entries for the parameters to the factory settings¹⁾. Enter the code via the "Reset" parameter (menu path: "Diagnosis" → "Reset").

There are various reset codes for the device. The following table illustrates which parameters are reset by the particular reset codes. Operation must be unlocked to reset parameters (see "Locking/unlocking operation" section (→  37)).

1) . The factory setting for the individual parameters is specified in the parameter description

 Any customer-specific configuration carried out at the factory is not affected by a reset (customer-specific configuration remains). If you want to change the customer-specific configuration carried out at the factory, please contact Endress+Hauser Service.

Reset code ¹⁾	Description and effect
62	PowerUp reset (warm start) <ul style="list-style-type: none"> ■ The device is restarted. ■ Data is read back anew from the EEPROM (process is reinitialized). ■ Any simulation which may be running is ended.
333	User reset <ul style="list-style-type: none"> ■ This code resets all the parameters apart from: <ul style="list-style-type: none"> - Device tag (022) - Linearization table - Operating hours (162) - Event logbook - Curr. trim 4 mA (135) - Curr. trim 20 mA (136) - Lo trim sensor (131) - Hi trim sensor (132) - Lo trim sensor (277) - Hi trim sensor (278) ■ Any simulation which may be running is ended. ■ The device is restarted.
7864	Total reset <ul style="list-style-type: none"> ■ This code resets all the parameters apart from: <ul style="list-style-type: none"> - Operating hours (162) - Event logbook - Lo trim sensor (131) - Hi trim sensor (132) - Lo trim sensor (277) - Hi trim sensor (278) ■ Any simulation which may be running is ended. ■ The device is restarted.

1) To be entered in "System" → "Management" → "Reset" (124)

 After a "Total reset" in FieldCare you have to press the "refresh" button in order to ensure that the measuring units are also reset.

10 Integrating transmitter using HART® protocol

Version data for the device

Firmware version	01.00.zz	<ul style="list-style-type: none"> ▪ On the title page of the Operating instructions ▪ On nameplate ▪ Firmware Version parameter Diagnostics → Device info → Firmware version
Manufacturer ID	17 (0x11)	Manufacturer ID. parameter Diagnosis → Instrument info → Manufacturer ID
Device type ID	39 (0x27)	Parameter Device ID Diagnosis → Instrument info → Device ID
HART protocol revision	6.0	---
Device revision	1	<ul style="list-style-type: none"> ▪ On transmitter nameplate ▪ Device revision parameter Diagnostics → Device info → Device revision

The suitable device description file (DD) for the individual operating tools is listed in the table below, along with information on where the file can be acquired.

Operating tools

Operating tool	Reference sources for device descriptions (DD and DTM)
FieldCare	<ul style="list-style-type: none"> ▪ www.endress.com → Download Area ▪ CD-ROM (contact Endress+Hauser) ▪ DVD (contact Endress+Hauser)
AMS Device Manager (Emerson Process Management)	www.endress.com → Download Area
SIMATIC PDM (Siemens)	www.endress.com → Download Area
Field Communicator 375, 475 (Emerson Process Management)	Use update function of handheld terminal

10.1 HART process variables and measured values

The following numbers are assigned to the process variables in the factory:

Process variable	Pressure	Level	
		Linear	Table active
First process variable (Primary variable)	0 (Measured differential pressure)	8 (Level before linearization)	9 (Tank content)
Second process variable (Secondary variable)	2 (Measured pressure HP)	0 (Measured differential pressure)	8 (Level before linearization)
Third process variable (Tertiary variable)	5 (Measured pressure LP)	2 (Measured pressure HP)	2 (Measured pressure HP)
Fourth process variable (Quaternary variable)	4 (Sensor temperature HP)	5 (Measured pressure LP)	5 (Measured pressure LP)

 The assignment of the device variables to the process variable is displayed in the **Expert → Communication → HART output** menu.

The assignment of the device variables to the process variable can be changed using HART command 51.

An overview of the possible device variables can be found in the following section.

10.2 Device variables and measured values

The following measured values are assigned to the individual device variables:

Device variable code	Measured value
0	Measured differential pressure
1	Corrected pressure
2	Measured pressure HP
3	Sensor press. HP
4	Sensor temperature HP
5	Measured pressure LP
6	Sensor press. LP
7	Sensor temperature LP
8	Level before linearization
9	Tank content
10	Process density
11	Temperature of electronics
12	HART input value

 The device variables can be queried from a HART® master using HART® command 9 or 33.

11 Commissioning

NOTICE

If a pressure smaller than the minimum permitted pressure or greater than the maximum permitted pressure is present at the device, the following messages are output in succession:

- ▶ "S140 Working range P LP/HP" or "F140 Working range P LP/HP" (depending on the setting in the "Alarm Behav. P" (050) parameter)
- ▶ "S841 Sensor range LP/HP" or "F841 Sensor range LP/HP" (depending on the setting in the "Alarm Behav. P" (050) parameter)
- ▶ "S945/F945 Pressure limit LP"
- ▶ "S971 Calibration"

11.1 Function check

Before commissioning your measuring point, ensure that the post-installation and post-connection check have been performed.

- "Post-installation check" checklist
- "Post-connection check" checklist

11.2 Unlocking/locking configuration

If the device is locked to prevent configuration, it must first be unlocked.

11.2.1 Locking/unlocking hardware

If the device is locked via the hardware (write protection switch) and an attempt is made to write to a parameter, the message "HW lock state is ON" appears.

In addition, the key symbol appears in the measured value display. To unlock, toggle the write protection switch, which is located under the display module (→  37) .

11.2.2 Locking/unlocking software



If the device is locked via the software (device access code), the key symbol appears in the measured value display. If an attempt is made to write to a parameter, a prompt for the device access code appears. To unlock, enter the user-defined device access code. .

11.3 Commissioning without an operating menu

11.3.1 Pressure measuring mode

If no local display is connected, the following functions are possible via the three keys on the electronic insert or externally on the device:

- Position adjustment (zero point correction)
- Setting lower range value and upper range value
- Device reset, see "Function of the operating elements" section, table (→  31).

-  ▪ The pressure applied must be within the nominal pressure limits of the respective sensor module. See information on the nameplate.
- Operation must be unlocked, see "Unlocking/locking configuration" section (→  42).
- The device is configured for the "Level" measuring mode as standard. You can change the measuring mode using the "Measuring mode" parameter, see "Commissioning with an operating menu" section (→  45).

⚠ WARNING

Changing the measuring mode affects the span (URV)

This situation can result in product overflow.

- ▶ If the measuring mode is changed, the setting for the span (URV) must be checked and readjusted if necessary.

Perform position adjustment (see information at the start of "Commissioning" section.)	
1	Device is installed. Process pressure is not present.
2	<input type="checkbox"/> Press key for at least 3 s.
3	Does the LED on the electronic insert light up briefly?
4	Yes No
5	Applied pressure for position adjustment has been accepted. Applied pressure for position adjustment has not been accepted. Observe the input limits.







Setting lower range value.	
1	Desired pressure for lower range value is present at device.
2	<input type="checkbox"/> Press key for at least 3 s.
3	Does the LED on the electronic insert light up briefly?
4	Yes No
5	Applied pressure for lower range value has been accepted. Applied pressure for lower range value has not been accepted. Observe the input limits.

Setting upper range value.	
1	Desired pressure for upper range value is present at device.
2	<input type="checkbox"/> Press key for at least 3 s.
3	Does the LED on the electronic insert light up briefly?
4	Yes No
5	Applied pressure for upper range value has been accepted. Applied pressure for upper range value has not been accepted. Observe the input limits.

11.3.2 Level measuring mode

If no local display is connected, the following functions are possible via the three keys on the electronic insert or externally on the device:

- Position adjustment (zero point correction)
- Setting the lower and upper pressure value and assigning to the lower or upper level value
- Device reset, see "Function of the operating elements" section, table (→  31).

-  The pressure applied must be within the nominal pressure limits of the respective sensor module. See information on the nameplate.
- Operation must be unlocked, see "Unlocking/locking configuration" section (→  42).
- The  and  keys have a function only in the case of the "Calibration Mode Wet" setting. The keys have no function at other settings.
- "Overview of level measurement" (→  48)
- The device is configured for the "Level" measuring mode as standard. You can change the measuring mode using the "Measuring mode" parameter, see "Commissioning with an operating menu" section. The following parameters are set to the following values at the factory: (→  45).
 - "Level Selection": In pressure
 - "Calibration Mode": Wet
 - "Unit Before Lin." or "Linear Range Limit": %
 - "Empty Calib.": 0.0 (corresponds to 4 mA value)
 - "Full Calib.": 100.0 (corresponds to 20 mA value)
 - "Empty Pressure": 0.0
 - "Full Pressure": 100.0

These parameters can be changed only via the local display or remote control, such as FieldCare.
- "Calibration Mode", "Level Type", "Empty Calib.", "Full Calib.", "Empty Pressure", and "Full Pressure" are parameter names that are used for the local display or remote control, such as FieldCare.

 **WARNING**

Changing the measuring mode affects the span (URV)

This situation can result in product overflow.

- If the measuring mode is changed, the setting for the span (URV) must be checked and readjusted if necessary.

Perform position adjustment (see information at the start of "Commissioning" section.)			
1	Device is installed. Process pressure is not present.		
2	 Press key for at least 3 s.		
3	Does the LED on the electronic insert light up briefly?		
4	<table border="1" style="width: 100%;"> <tr> <td style="width: 50%; text-align: center;">Yes</td> <td style="width: 50%; text-align: center;">No</td> </tr> </table>	Yes	No
Yes	No		
5	<table border="1" style="width: 100%;"> <tr> <td style="width: 50%;">Applied pressure for position adjustment has been accepted.</td> <td style="width: 50%;">Applied pressure for position adjustment has not been accepted. Observe the input limits.</td> </tr> </table>	Applied pressure for position adjustment has been accepted.	Applied pressure for position adjustment has not been accepted. Observe the input limits.
Applied pressure for position adjustment has been accepted.	Applied pressure for position adjustment has not been accepted. Observe the input limits.		





Set the lower pressure value.			
1	Desired pressure for lower pressure value ("Empty Pressure") is present at the device.		
2	 Press key for at least 3 s.		
3	Does the LED on the electronic insert light up briefly?		
4	<table border="1" style="width: 100%;"> <tr> <td style="width: 50%; text-align: center;">Yes</td> <td style="width: 50%; text-align: center;">No</td> </tr> </table>	Yes	No
Yes	No		
5	<table border="1" style="width: 100%;"> <tr> <td style="width: 50%;">Applied pressure was saved as the lower pressure value ("Empty Pressure") and assigned to the lower level value ("Empty Calib.).</td> <td style="width: 50%;">Applied pressure was not saved as the lower pressure value. Observe the input limits.</td> </tr> </table>	Applied pressure was saved as the lower pressure value ("Empty Pressure") and assigned to the lower level value ("Empty Calib.).	Applied pressure was not saved as the lower pressure value. Observe the input limits.
Applied pressure was saved as the lower pressure value ("Empty Pressure") and assigned to the lower level value ("Empty Calib.).	Applied pressure was not saved as the lower pressure value. Observe the input limits.		

Set the upper pressure value.	
1	Desired pressure for upper pressure value ("Full Pressure") is present at device.
2	 Press key for at least 3 s.
3	Does the LED on the electronic insert light up briefly?

Set the upper pressure value.		
4	Yes	No
5	Applied pressure was saved as the upper pressure value ("Full Pressure") and assigned to the upper level value ("Full Calib.").	Applied pressure was not saved as the upper pressure value. Observe the input limits.

11.4 Commissioning with an operating menu



Commissioning comprises the following steps:

- Function check (→  42)
- Selecting the language, measuring mode, high-pressure side, and pressure engineering unit (→  45)
- Position adjustment (→  47)
- Configuring measurement:
 - Pressure measurement (→  61)
 - Level measurement (→  48)

11.5 Selecting the language, measuring mode, high-pressure side, and pressure engineering unit

11.5.1 Configure language via onsite display

Language (000)

Navigation	  Main menu → Language
Write permission	Operators/Service engineers/Expert
Description	Select the menu language for the local display.
Options	<ul style="list-style-type: none"> ▪ English ▪ Another language (as selected when ordering the device) ▪ Possibly a third language (language of the manufacturing plant)
Factory setting	English

11.5.2 Configuring language via operating tool (FieldCare)

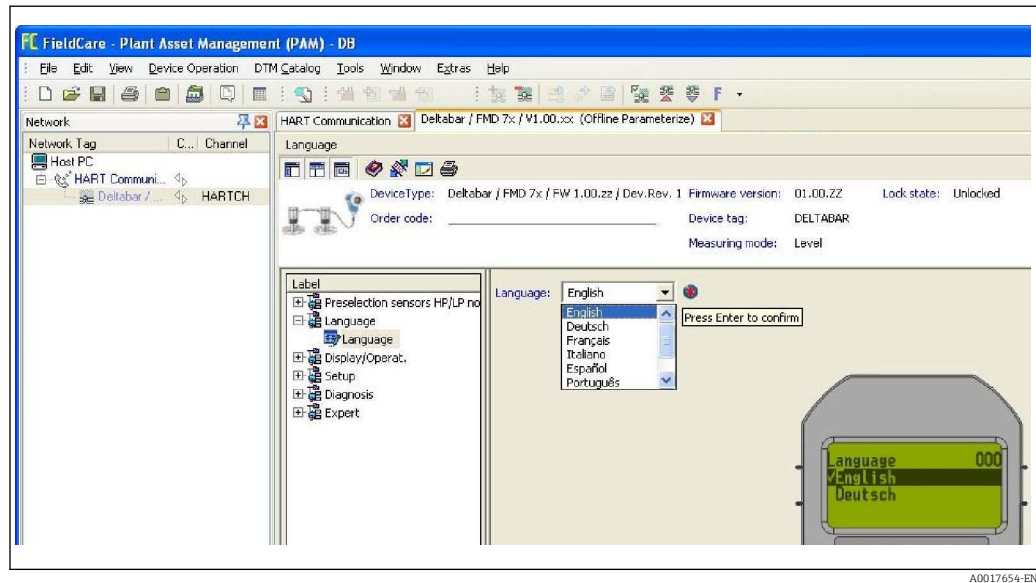

11.5.3 Measuring mode selection

Measuring mode (005)

Navigation	Setup → Measuring mode
Write permission	Operators/Service engineers/Expert
Description	Select the measuring mode. The operating menu is structured differently depending on the measuring mode selected.
Options	<ul style="list-style-type: none"> ■ Pressure ■ Level
Factory setting	Level

WARNING

Changing the measuring mode affects the span (URV)

This situation can result in product overflow.

- ▶ If the measuring mode is changed, the setting for the span (URV) must be checked in the "Setup" operating menu and readjusted if necessary.

11.5.4 Defining the high-pressure side



High Press. Side (183)

Navigation	Setup → High Press. Side
Write permission	Operators/Service engineers/Expert

Description	Define which sensor module corresponds to the high-pressure side.
Options	<ul style="list-style-type: none"> ■ Sensor module HP ■ Sensor module LP
Factory setting	Sensor module HP

11.5.5 Press. Eng. Unit selection



Press. Eng. Unit (125)

Navigation	  Setup → Press. Eng. Unit
Write permission	Operators/Service engineers/Expert
Description	Select the pressure engineering unit. If a new pressure engineering unit is selected, all pressure-specific parameters are converted and displayed with the new unit.
Options	<ul style="list-style-type: none"> ■ mbar, bar ■ mmH2O, mH2O, ■ in H2O, ftH2O ■ Pa, kPa, MPa ■ psi ■ mmHg, inHg ■ kgf/cm²
Factory setting	mbar, bar or psi depending on the sensor module nominal measuring range, or as per order specifications

11.6 Pos. Zero Adjust

The pressure resulting from the orientation of the device can be corrected here.

Corrected press. (172)

Navigation	  Setup → Corrected Press.
Write permission	Operators/Service engineers/Expert
Description	Displays the measured pressure after the differential pressure buildup and position adjustment.
Note	If this value is not equal to "0", it can be corrected to "0" by the position adjustment.

Pos. Zero Adjust (007)

Navigation	  Setup → Pos. Zero Adjust
-------------------	--







Write permission	Operators/Service engineers/Expert
Description	Position adjustment – the pressure difference between zero (set point) and the measured differential pressure need not be known.
Options	<ul style="list-style-type: none"> ■ Confirm ■ Cancel
Example	<ul style="list-style-type: none"> ■ Measured value = 2.2 mbar (0.033 psi) ■ You correct the measured value via the "Pos. Zero Adjust" parameter with the "Confirm" option. This means that you are assigning the value 0.0 to the pressure present. ■ Measured value (after pos. zero adjust) = 0.0 mbar ■ The current value is also corrected.
Factory setting	Cancel

11.7 Configuring level measurement

11.7.1 Information on level measurement

-  You have a choice of two methods for calculating the level: "In pressure" and "In height". The table in the "Overview of level measurement" section that follows provides you with an overview of these two measuring tasks.
- The limit values are not checked, i.e. the values entered must be appropriate for the sensor module and the measuring task for the device to be able to measure correctly.
 - Customer-specific units are not possible.
 - There is no unit conversion.
 - The values entered for "Empty Calib./Full Calib.", "Empty Pressure/Full Pressure", "Empty Height/Full Height", and "Set LRV/Set URV" must be at least 1% apart. The value will be rejected, and a warning message displayed, if the values are too close together.

11.7.2 Overview of level measurement

Measuring task	Level Selection	Measured variable options	Description	Measured value display
Calibration is performed by entering two pressure-level value pairs.	"In pressure"	Via the "Unit before lin. (025)" parameter (→  85): %, level, volume or mass units.	<ul style="list-style-type: none"> ■ Calibration with reference pressure (wet calibration) (→  49) ■ Calibration without reference pressure (dry calibration) (→  51) 	The measured value display and the "Level before lin (019)" (→  82) parameter show the measured value.
Calibration is performed by entering the density and two height-level value pairs.	"In height"		<ul style="list-style-type: none"> ■ Calibration with reference pressure (wet calibration) (→  53) ■ Calibration without reference pressure (dry calibration) (→  55) 	

11.7.3 "In pressure" level selection Calibration with reference pressure (wet calibration)

Example:

In this example, the level in a tank should be measured in "m". The maximum level is 3 m (9.8 ft). The pressure range is derived from the level and the density of the medium. In this situation, the device sets the pressure range to 0 to 300 mbar (4.5 psi).

Prerequisite:

- The measured variable is in direct proportion to the pressure.
 - The tank can be filled and emptied.
- i** The values entered for "Empty Calib./Full Calib.", "Set LRV/Set URV", and the applied pressures must be at least 1% apart. The value will be rejected, and a warning message displayed, if the values are too close together. Further limit values are not checked, i.e. the values entered must be appropriate for the sensor module and the measuring task for the device to be able to measure correctly.

Description	
1	Carrying out "Position adjustment" (→ 47)
2	Select the "Level" measuring mode via the "Measuring mode (005)" parameter. Menu path: Setup → Measuring Mode
3	Select a pressure engineering unit via the "Press Eng. Unit (125)" parameter, here "mbar" for example. Menu path: Setup → Press Eng. Unit
4	Select the "In pressure" level mode via the "Level Selection (024)" parameter. Menu path: Setup → Extended Setup → Level → Level Selection.

A See table, step 7.

B See table, step 8.

A0017661

Description	
5	Select a level unit via the "Unit before lin. (025)" parameter, here "m" for example. Menu path: Setup → Extended Setup → Level → Unit Before Lin.
6	Select the "Wet" option via the "Calibration mode (027)" parameter. Menu path: Setup → Extended Setup → Level → Calibration Mode
7	The vessel is filled to the lower calibration point. The pressure here is, for example, 0 mbar (0 psi). Select "Empty Calib. (028)" parameter. Menu path: Setup → Extended Setup → Level → Empty Calibration Enter the level value, here 0 m for example. The pressure value present is assigned to the lower level value by confirming the value.
8	The vessel is filled to the upper calibration point. The pressure here is, for example, 300 mbar (4.35 psi). Select the "Full Calib. (031)" parameter. Menu path: Setup → Extended Setup → Level → Full Calibration Enter the level value, here 3 m (9.8 ft) for example. The pressure value present is assigned to the upper level value by confirming the value.
9	If calibration is performed with a medium other than the process medium, enter the density of the calibration medium in "Adjust density (034)". Menu path: Setup → Extended Setup → Level → Adjust Density
10	Use the "Set LRV (166)" parameter to set the level value for the lower current value (4 mA) (0 m (0 ft)). Menu path: Setup → Extended Setup → Current Output → Set LRV
11	Use the "Set URV (167)" parameter to set the level value for the upper current value (20 mA) (3 m (9.8 ft)). Menu path: Setup → Extended Setup → Current Output → Set URV
12	If the process uses a medium other than that on which the calibration was based, the new density must be specified in the "Process Density (035)" parameter. Menu path: Setup → Extended Setup → Level → Process Density.
13	Result: The measuring range is set for 0 to 3 m (9.8 ft).

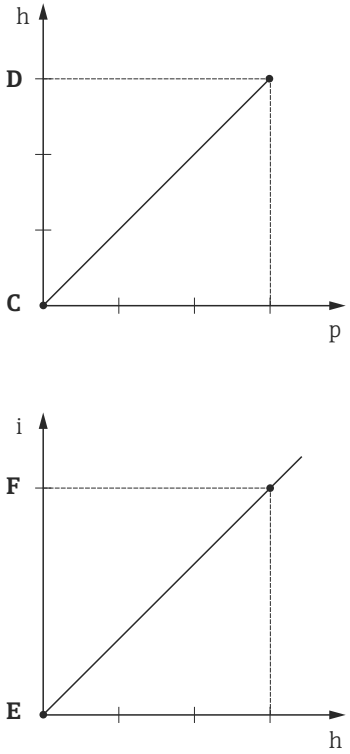

C See table, step 7.
D See table, step 8.
E See table, step 10.
F See table, step 11.
h Height
i Current value
p Pressure

A0017658



i For this level mode, the measured variables %, level, volume and mass are available, see "Unit before lin. (025)" (→ 85).

11.7.4 "In pressure" level selection Calibration without reference pressure (dry calibration)

Example:

In this example, the volume in a tank should be measured in liters. The maximum volume of 1000 liters (264 gal) corresponds to a pressure of 450 mbar (6.53 psi). The minimum volume of 0 liters corresponds to a pressure of 50 mbar (0.73 psi) since the device is mounted below the start of the level measuring range.

Prerequisite:

- The measured variable is in direct proportion to the pressure.
- This is a theoretical calibration i.e. the pressure and volume values for the lower and upper calibration point must be known.
-  ■ The values entered for "Empty Calib./Full Calib.", "Empty Pressure/Empty Pressure" and "Set LRV/Set URV" must be at least 1% apart. The value will be rejected, and a warning message displayed, if the values are too close together. Further limit values are not checked, i.e. the values entered must be appropriate for the sensor module and the measuring task for the device to be able to measure correctly.
- Due to the orientation of the device, there may be pressure shifts in the measured value, i.e. when the vessel is empty or partly filled, the measured value is not zero. For information on how to perform position adjustment, see (→  47).

Description	
1	Select the "Level" measuring mode via the "Measuring mode (005)" parameter. Menu path: Setup → Measuring Mode
2	Select a pressure engineering unit via the "Press Eng. Unit (125)" parameter, here "mbar" for example. Menu path: Setup → Press Eng. Unit
3	Select the "In pressure" level mode via the "Level Selection (024)" parameter. Menu path: Setup → Extended Setup → Level → Level Selection.
4	Select a volume unit via the "Unit before lin. (025)" parameter, here "l" (liters) for example. Menu path: Setup → Extended Setup → Level → Unit Before Lin.

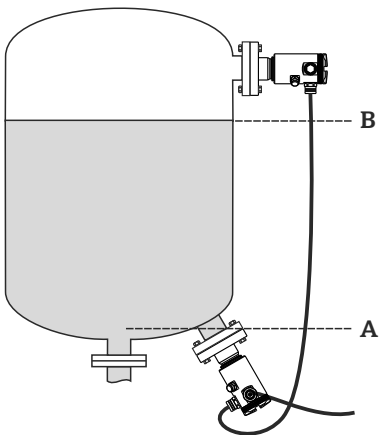

A See table, steps 6 and 7.

B See table, steps 8 and 9.

A0017661

Description	
5	Select the "Dry" option via the "Calibration mode (027)" parameter. Menu path: Setup → Extended Setup → Level → Calibration Mode
6	Enter the volume value for the lower calibration point via the "Empty Calib. (028)" parameter, here 0 liters for example. Menu path: Setup → Extended Setup → Level → Empty Calibration
7	Enter the pressure value for the lower calibration point via the "Empty Pressure (029)" parameter, here 50 mbar (0.75 psi), for example. Menu path: Setup → Extended Setup → Level → Empty Pressure
8	Enter the volume value for the upper calibration point via the "Full Calib. (031)" parameter, here 1000 liters (264 gal) for example. Menu path: Setup → Extended Setup → Level → Full Calibration
9	Enter the pressure value for the upper calibration point via the "Full Pressure (032)" parameter, here 450 mbar (6.75 psi), for example. Menu path: Setup → Extended Setup → Level → Full Pressure
10	"Adjust density (034)" contains the factory setting 1.0, but this value can be changed if required. Menu path: Setup → Extended Setup → Level → Adjust Density
11	Set the volume value for the lower current value (4 mA) via the "Set LRV (166)" parameter (0 l). Menu path: Setup → Extended Setup → Current Output → Set LRV
12	Set the volume value for the upper current value (20 mA) via the "Set URV (167)" parameter (1000 l (264 gal)). Menu path: Setup → Extended Setup → Current Output → Set URV
13	If the process uses a medium other than that on which the calibration was based, the new density must be specified in the "Process Density" parameter. Menu path: Setup → Extended Setup → Current Output → Process Density.
14	Result: The measuring range is set for 0 to 1000 l (264 gal).

C See table, step 6.
D See table, step 7.
E See table, step 8.
F See table, step 9.
G See table, step 11.
H See table, step 12.
i Current value
p Pressure
v Volume

A0017662

i For this level mode, the measured variables %, level, volume and mass are available, see "Unit before lin. (025)" (→ 85).

11.7.5 "In height" level selection Calibration with reference pressure (wet calibration)

Example:

In this example, the volume in a tank should be measured in liters. The maximum volume of 1000 liters (264 gal) corresponds to a level of 4.5 m (15 ft). The minimum volume of 0 liters corresponds to a level of 0.5 m (1.6 ft) since the device is mounted below the start of the level measuring range. The density of the fluid is 1 g/cm³ (1 SGU).

Prerequisite:

- The measured variable is in direct proportion to the pressure.
- The tank can be filled and emptied.

i The values entered for "Empty Calib./Full Calib.", "Set LRV/Set URV", and the applied pressure values must be at least 1% apart. The value will be rejected, and a warning message displayed, if the values are too close together. Further limit values are not checked, i.e. the values entered must be appropriate for the sensor module and the measuring task for the device to be able to measure correctly.

Description	
1	Perform "position adjustment" (→ 47).
2	Select the "Level" measuring mode via the "Measuring mode (005)" parameter. Menu path: Setup → Measuring Mode
3	Select a pressure engineering unit via the "Press Eng. Unit (125)" parameter, here "mbar" for example. Menu path: Setup → Press Eng. Unit
4	Select the "In height" level mode via the "Level selection (024)" parameter. Menu path: Setup → Extended Setup → Level → Level Selection.

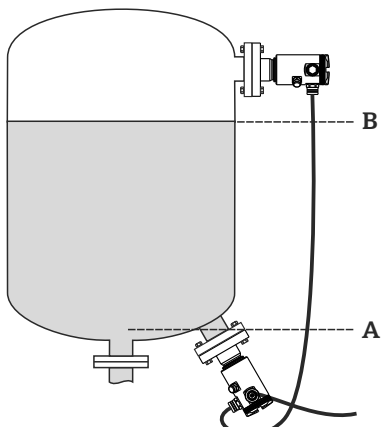

A See table, step 8.

B See table, step 9.

A0017661

Description	
5	Select a volume unit via the "Unit before lin. (025)" parameter, here "l" (liters) for example. Menu path: Setup → Extended Setup → Level → Unit Before Lin.
6	Select a level unit via the "Height unit (026)" parameter, here "m" for example. Menu path: Setup → Extended Setup → Level → Height Unit
7	Select the "Wet" option via the "Calibration mode (027)" parameter. Menu path: Setup → Extended Setup → Level → Calibration Mode
8	Vessel is filled up to 0.5 m (1.6 ft), (49 mbar (0.72 psi)). Enter the volume value for the lower calibration point via the "Empty Calib. (028)" parameter, here 0 liters for example. Menu path: Setup → Extended Setup → Level → Empty Calibration
9	Vessel is filled up to 4.5 m (15 ft), (441 mbar (6.40 psi)). Enter the volume value for the upper calibration point via the "Full Calib. (031)" parameter, here "1000 liters" (264 gal), for example. Menu path: Setup → Extended Setup → Level → Full Calibration
10	Enter the density of the calibration medium in "Adjust density (034)", here 1 g/cm ³ (1 SGU), for example. Menu path: Setup → Extended Setup → Level → Adjust Density
11	Set the volume value for the lower current value (4 mA) via the "Set LRV (166)" parameter (0 l). Menu path: Setup → Extended Setup → Current Output → Set LRV
12	Set the volume value for the upper current value (20 mA) via the "Set URV (167)" parameter (1000 l (264 gal)). Menu path: Setup → Extended Setup → Current Output → Set URV
13	If the process uses a medium other than that on which the calibration was based, the new density must be specified in the "Process Density (035)" parameter. Menu path: Setup → Extended Setup → Level → Process Density.
14	Result: The measuring range is set for 0 to 1000 l (264 gal).

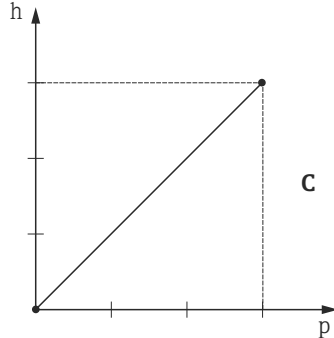
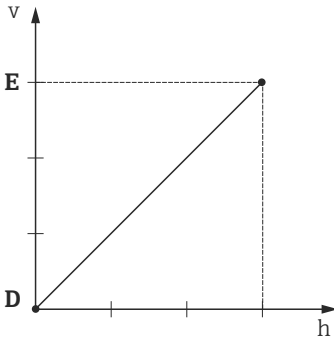
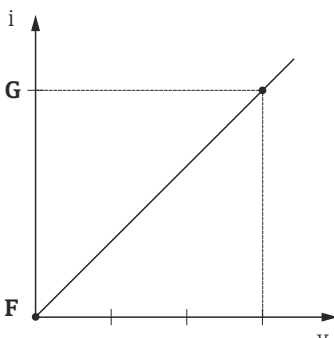
C See table, step 10.
 D See table, step 8.
 E See table, step 9.
 F See table, step 11.
 G See table, step 12.
 h Height
 i Current value
 p Pressure
 v Volume

A0017666

i For this level mode, the measured variables %, level, volume and mass are available, see "Unit before lin. (025)" (→ 85).

11.7.6 "In height" level selection Calibration without reference pressure (dry calibration)

Example:

In this example, the volume in a tank should be measured in liters. The maximum volume of 1000 liters (264 gal) corresponds to a level of 4.5 m (15 ft). The minimum volume of 0 liters corresponds to a level of 0.5 m (1.6 ft) since the device is mounted below the start of the level measuring range.

Prerequisite:

- The measured variable is in direct proportion to the pressure.
- This is a theoretical calibration i.e. the height and volume values for the lower and upper calibration point must be known.
- The values entered for "Empty Calib./Full Calib.", "Empty height/Full height" and "Set LRV/Set URV" must be at least 1% apart. The value will be rejected, and a warning message displayed, if the values are too close together. Further limit values are not checked, i.e. the values entered must be appropriate for the sensor module and the measuring task for the device to be able to measure correctly.
- Due to the orientation of the device, there may be pressure shifts in the measured value, i.e. when the vessel is empty or partly filled, the measured value is not zero. For information on how to perform position adjustment, see (→ 47).

Description	
1	Select the "Level" measuring mode via the "Measuring mode (005)" parameter. Menu path: Setup → Measuring Mode
2	Select a pressure engineering unit via the "Press Eng. Unit (125)" parameter, here "mbar" for example. Menu path: Setup → Press Eng. Unit
3	Select the "In height" level mode via the "Level selection (024)" parameter. Menu path: Setup → Extended Setup → Level → Level Selection.
4	Select a volume unit via the "Unit before lin. (025)" parameter, here "l" (liters) for example. Menu path: Setup → Extended Setup → Level → Unit Before Lin.

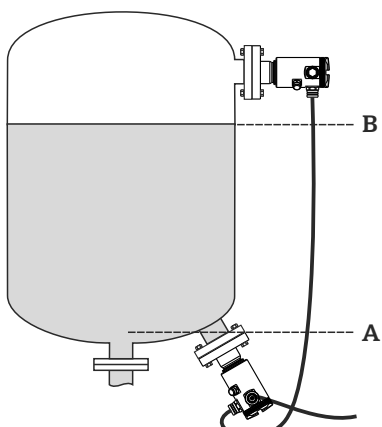

A See table, steps 7 and 8.

B See table, steps 9 and 10.

A0017661

	Description	
5	Select a level unit via the "Height unit (026)" parameter, here "m" for example. Menu path: Setup → Extended Setup → Level → Height Unit	
6	Select the "Dry" option via the "Calibration mode (027)" parameter. Menu path: Setup → Extended Setup → Level → Calibration Mode	
7	Enter the volume value for the lower calibration point via the "Empty Calib. (028)" parameter, here 0 liters for example. Menu path: Setup → Extended Setup → Level → Empty Calibration	
8	Enter the height value for the lower calibration point via the "Empty height (030)" parameter, here 0.5 m (1.6 ft) for example. Menu path: Setup → Extended Setup → Level → Empty Height	
9	Enter the volume value for the upper calibration point via the "Full Calib. (031)" parameter, here 1000 liters (264 gal) for example. Menu path: Setup → Extended Setup → Level → Full Calibration	
10	Enter the height value for the upper calibration point via the "Full height (033)" parameter, here 4.5 m (15 ft) for example. Menu path: Setup → Extended Setup → Level → Full Height	
11	Enter the density of medium via the "Adjust density (034)" parameter, here "1 g/cm3" (1 SGU) for example. Menu path: Setup → Extended Setup → Level → Adjust Density	
12	Set the volume value for the lower current value (4 mA) via the "Set LRV (166)" parameter (0 l). Menu path: Setup → Extended Setup → Current Output → Set LRV	
13	Set the volume value for the upper current value (20 mA) via the "Set URV (167)" parameter (1000 l (264 gal)). Menu path: Setup → Extended Setup → Current Output → Set URV	
13	If the process uses a medium other than that on which the calibration was based, the new density must be specified in the "Process Density" parameter. Menu path: Setup → Extended Setup → Current Output → Process Density.	<p>C See table, step 11. D See table, step 7. E See table, step 9. F See table, step 12. G See table, step 13. h Height i Current value p Pressure v Volume</p>
14	Result: The measuring range is set for 0 to 1000 l (264 gal).	

A0017666

 For this level mode, the measured variables %, level, volume and mass are available, see "Unit before lin. (025)" (→ 85).

11.7.7 Calibration with partially-filled vessel (wet calibration)

Example:

This example explains a wet calibration for cases in which it is not possible to empty the vessel and then fill it to 100%. During this wet calibration, a level of 20% is used as the calibration point for "Empty" and a level of "80%" is used as the calibration point for "Full". The calibration is then extended to 0% to 100% and lower range-value (LRV)/upper range-value (URV) are adapted accordingly.

Prerequisite:

- The default value in level mode for the calibration mode is "Wet".
- This value can be adjusted: Menu path: Setup → Extended Setup → Level → Calibration Mode

Description	
1	Select the "Level" measuring mode via the "Measuring mode (005)" parameter. Menu path: Setup → Measuring Mode
2	Select a unit via the "Unit before lin. (025)" parameter, here "%" for example. Menu path: Setup → Extended Setup → Level → Unit Before Lin.
3	20% of the vessel is full. Enter the level value for the lower calibration value via the "Empty Calib. (028)" parameter, here 20% for example. Menu path: Setup → Extended Setup → Level → Empty Calibration
4	80% of the vessel is full. Enter the level value for the upper calibration value via the "Full Calib. (031)" parameter, here 80% for example. Menu path: Setup → Extended Setup → Level → Full Calibration
5	The pressure values for full/empty calibration are automatically recorded and applied. The upper range value (URV) and lower range value (LRV) automatically accept the values that were entered in "Empty Calib. (028)" and "Full Calib. (031)". These automatically entered values can be edited if necessary and, for example, changed to a value ranging from 0 to 100%.

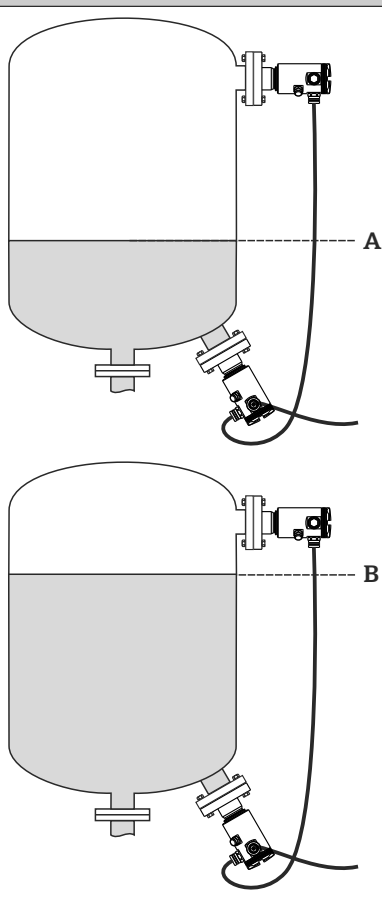

A See table, step 3
B See table, step 4

A0017668

-  If the process uses a medium other than that on which the calibration was based, the new density must be specified in the "Process Density (035)" parameter. In this case, you have to enter the various densities via the following menu path:**
- Setup → Extended Setup → Level → Adjust Density (034) (e.g. 1.0 kg/l for water)
 - Setup → Extended Setup → Level → Process Density (035) (e.g. 0.8 kg/l for oil)

11.8 Linearization

11.8.1 Manual entry of a linearization table

Example:

In this example, the volume in a tank with a conical outlet should be measured in m^3 .

Prerequisite:

- This is a theoretical calibration, i.e. the points for the linearization table are known.
- The "Level" measuring mode has been selected.
- A level calibration has been performed.
- The linearization characteristic must rise or fall continuously.
- For a description of the parameters mentioned, see the "Description of device parameters" section (→  78).

WARNING

Changing the measuring mode affects the span (URV)

This situation can result in product overflow.

- ▶ If the measuring mode is changed, the setting for the span (URV) must be checked in the "Setup" operating menu and readjusted if necessary.

Description	
1	Select the "Manual entry" option via the "Lin. mode (037)" parameter. Menu path: Setup → Extended Setup → Linearization → Lin. Mode
2	Select using the "Unit after lin. (038)" parameter, e.g. m^3 . Menu path: Setup → Extended Setup → Linearization → Unit After Lin.
3	Enter the number of the point in the table (e.g. 1) via the "Line numb. (039)" parameter. Menu path: Setup → Extended Setup → Linearization → Line-numb
	The level is entered via the "X-value (040)" parameter, here 0 m for example. Confirm your entry. Menu path: Setup → Extended Setup → Linearization → X-value
	Using the "Y-val. (041)" parameter, enter the corresponding volume value, here 0 m^3 for example, and confirm the value. Menu path: Setup → Extended Setup → Linearization → Y-val.

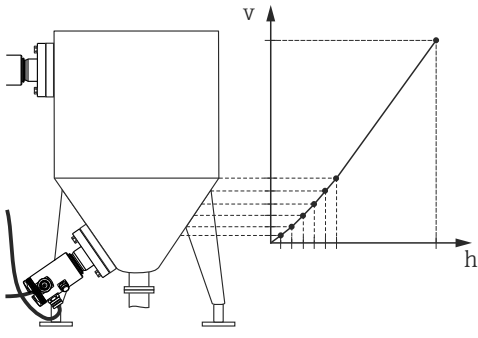

h Height

v Volume

A0017669

Description	
4	<p>To enter another point in the table, select the "Next point" option via the "Edit Table (042)" parameter. Enter the next point as explained in Step 3. Menu path: Setup → Extended Setup → Linearization → Edit Table</p>
5	<p>Once all the points have been entered in the table, select the "Activate table" option via the "Lin. mode (037)" parameter. Menu path: Setup → Extended Setup → Linearization → Lin. Mode</p>
6	<p>Result: Result: The measured value after linearization is displayed.</p>

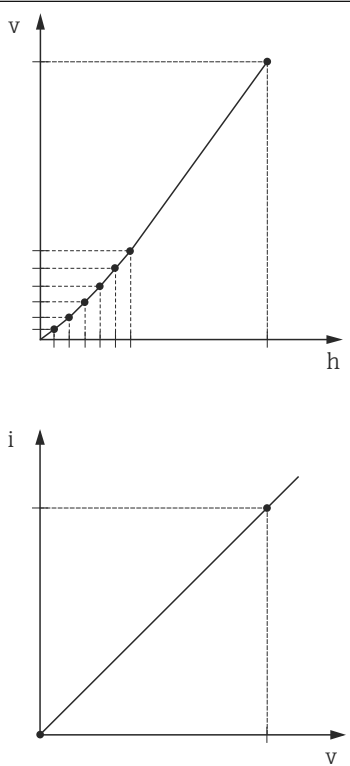

h Height
i Current value
v Volume

A0017670

- i Error message F510 "Linearization" and alarm current as long as the table is being entered and until the table is activated.
- Error message F511/F512 "Linearization" and alarm current as long as the linearization table consists of fewer than 2 points.
- The lower range value (= 4mA) is defined by the smallest point in the table. The upper range value (= 20mA) is defined by the greatest point in the table.
- Using the parameters "Set LRV" and "Set URV", you can change the allocation of the volume/mass values to the current values.

11.8.2 Manual entry of a linearization table via operating tool

Using an operating tool based on FDT technology (e.g. FieldCare), you can enter linearization using a module specially designed for this purpose. This provides you with an overview of the selected linearization, even during entry. In addition, it is possible to configure different tank shapes in FieldCare (menu "Device Operation" → "Device Functions" → "Additional Functions" → "Linearization Table").

- i The linearization table may also be entered manually point by point in the operating tool menu (see (→ 58) section).

11.8.3 Semi-automatic entry of a linearization table

Example:

In this example, the volume in a tank with a conical outlet should be measured in m³.

Prerequisite:

- The tank can be filled or emptied. The linearization characteristic must rise or fall continuously.
- The "Level" measuring mode has been selected.
- Level calibration is performed (see section from (→ 48))
- For a description of the parameters mentioned, see the "Description of device parameters" section (→ 78).

⚠ WARNING

Changing the measuring mode affects the span (URV)

This situation can result in product overflow.

- ▶ If the measuring mode is changed, the setting for the span (URV) must be checked in the "Setup" operating menu and readjusted if necessary.

Description	
1	Select the "Semiautom. entry" option via the "Lin. mode (037)" parameter. Menu path: Setup → Extended Setup → Linearization → Lin. Mode
2	Select using the "Unit after lin. (038)" parameter, e.g. m ³ . Menu path: Setup → Extended Setup → Linearization → Unit After Lin.
3	Fill the tank to the height of the 1st point.
4	Enter the number of the point in the table (e.g. 1) via the "Line numb. (039)" parameter. Menu path: Setup → Extended Setup → Linearization → Line-numb The level at the current time is displayed using the "X-value (193)" parameter. Menu path: Setup → Extended Setup → Linearization → X-value Using the "Y-val. (041)" parameter, enter the corresponding volume value, here 0 m ³ for example, and confirm the value. Menu path: Setup → Extended Setup → Linearization → Y-val.
5	To enter another point in the table, continue filling the tank and select the "Next point" option via the "Edit Table (042)" parameter. Enter the next point as explained in Step 4. Menu path: Setup → Extended Setup → Linearization → Edit Table
6	Once all the points have been entered in the table, select the "Activate table" option via the "Lin. mode (037)" parameter. Menu path: Setup → Extended Setup → Linearization → Lin. Mode
7	Result: Result: The measured value after linearization is displayed.

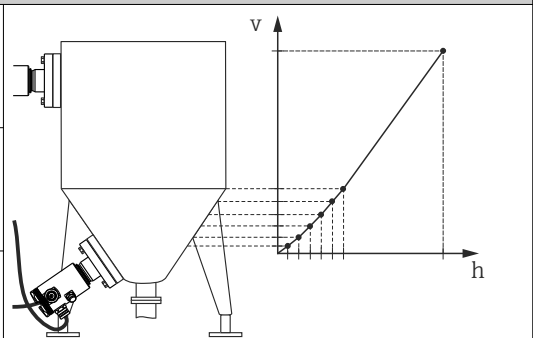

h Height
v Volume

A0017669

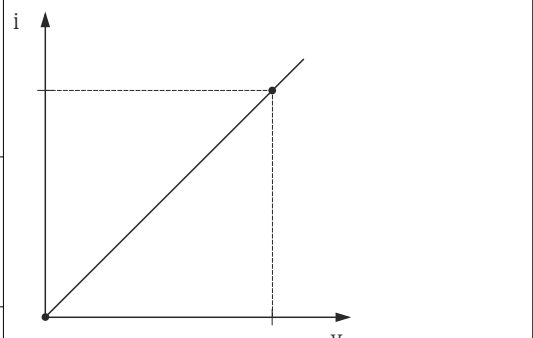
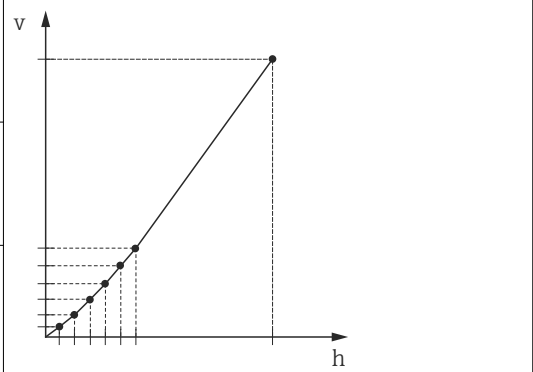

h Height
i Current value
v Volume

A0017670

- i
 - Error message F510 "Linearization" and alarm current as long as the table is being entered and until the table is activated.
 - The lower range value (= 4mA) is defined by the smallest point in the table. The upper range value (= 20mA) is defined by the greatest point in the table.
 - Using the parameters "Set LRV" and "Set URV", you can change the allocation of the volume/mass values to the current values.

11.9 Configuring pressure measurement

11.9.1 Calibration without reference pressure (dry calibration)

Example:

In this example, a device with a 400 mbar (6 psi) sensor module is configured for the 0 to +300 mbar (4.4 psi) measuring range, i.e. the 4 mA value and the 20 mA value are assigned 0 mbar and 300 mbar (4.4 psi) respectively.

Prerequisite:

This is a theoretical calibration, i.e. the pressure values for the lower and upper range are known. It is not necessary to apply pressure.

- i

Due to the orientation of the device, there may be pressure shifts in the measured value, i.e. the measured value is not zero in a pressureless condition. For information on how to perform position adjustment, see Pos. Zero Adjust(→ 47) section.

Description	
1	Select the "Level" measuring mode via the "Measuring mode (005)" parameter. Menu path: Setup → Measuring Mode
2	Select a pressure engineering unit via the "Press Eng. Unit (125)" parameter, here "mbar" for example. Menu path: Setup → Press Eng. Unit
3	Select "Set LRV (013)" parameter. Menu path: Setup → Set LRV Enter and confirm the value (here 0 mbar (0 psi)) for the "Set LRV" parameter. This pressure value is assigned to the lower current value (4 mA).
4	Select the "Set URV (014)" parameter. Menu path: Setup → Set URV Enter and confirm the value (here 300 mbar (4.5 psi)) for the "Set URV (014)" parameter. This pressure value is assigned to the upper current value (20 mA).
5	Result: The measuring range is configured for 0 to +300 mbar (4.5 psi).

A

B

i

p

A See table, step 3.

B See table, step 4.

i Current value

p Pressure

A0017671



11.9.2 Calibration with reference pressure (wet calibration)

Example:

In this example, a device with a 400 mbar (6 psi) sensor module is configured for the 0 to +300 mbar (4.4 psi) measuring range, i.e. the 4 mA value and the 20 mA value are assigned 0 mbar and 300 mbar (4.4 psi) respectively.

Prerequisite:

The pressure values 0 mbar and 300 mbar (4.4 psi) can be specified. For example, the device is already installed.

 For a description of the parameters mentioned, see the "Description of device parameters" section (→  78).

Description	
1	Perform position adjustment (→  47).
2	Select the "Pressure" measuring mode via the "Measuring mode (005)" parameter. Menu path: Setup → Measuring Mode
3	Select a pressure engineering unit via the "Press Eng. Unit (125)" parameter, here "mbar" for example. Menu path: Setup → Press Eng. Unit
4	The pressure for the LRV (4 mA value) is present at the device, here 0 mbar (0 psi) for example.
	Select the "Get LRV (015)" parameter. Menu path: Setup → Extended Setup → Current output → Get LRV.
	Confirm the present value by selecting "Apply". The present pressure value is assigned to the lower current value (4 mA).
5	The pressure for the URV (20 mA value) is present at the device, here 300 mbar (4.4 psi) for example.
	Select the "Get URV (016)" parameter. Menu path: Setup → Extended Setup → Current output → Get URV
	Confirm the present value by selecting "Apply". The present pressure value is assigned to the upper current value (20 mA).
6	Result: The measuring range is configured for 0 to +300 mbar (4.5 psi).

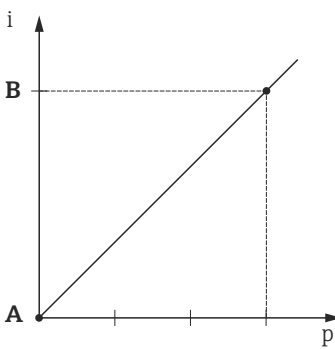

A0017671

A See table, step 4.
 B See table, step 5.
 i Current value
 p Pressure

11.10 Backing up or duplicating the device data

The following options are available to you with an operating tool that is based on FDT technology (e.g. FieldCare):

- Storage/recovery of configuration data.
- Duplication of device parameters.
- Transfer of all relevant parameters when replacing electronic inserts.

Use the following parameter for this:

Navigation	 Expert → System → Management → Download select.
Write permission	Operators/Service engineers/Expert
Description	Selection of data packages for up/download function in Fieldcare and PDM.
Prerequisite	DIP switch set to "SW" and "Damping" set to "on". If you download using the factory setting "Configuration copy", all parameters required for a measurement will be downloaded. The functionality of the "Electronics replace" setting is reserved for Endress+Hauser Service and can be accessed only if the correct device access code is entered.
Options	<ul style="list-style-type: none"> ▪ Configuration copy: This option overwrites general configuration parameters with the exception of the serial number, order number, calibration, pos. zero adjust, application and day information. ▪ Device replacement: This option overwrites general configuration parameters with the exception of the serial number, order number, calibration and pos. zero adjust. ▪ Electronics replace: This option overwrites general configuration parameters.
Factory setting	Configuration copy

11.11 Configuring the local display

11.11.1 Adjusting the onsite display

The onsite display can be adjusted in the following menu:

Display/operat. (→  73)

11.12 Protecting settings from unauthorized access





The settings can be protected from unauthorized access in two ways:

- Locking via write protection switch (hardware locking)
- Locking via parameter (software locking)

12 Diagnostics and troubleshooting

12.1 Troubleshooting

General errors

Error	Possible cause	Remedy
Device is not responding.	Supply voltage does not match that specified on the nameplate.	Apply correct voltage.
	Supply voltage has incorrect polarity.	Reverse polarity of supply voltage.
	Connecting cables are not in contact with the terminals.	Check the connection of the cables and correct if necessary.
No display	Onsite display is set too bright or too dark.	<ul style="list-style-type: none"> ▪ Set the local display brighter by simultaneously pressing  and . ▪ Set the local display darker by simultaneously pressing  and .
	Connector for local display is not properly connected.	Ensure connector is properly connected.
	Onsite display is defective.	Replace onsite display.
Output current < 3.6 mA	Signal line is not wired correctly.	Check wiring.
	Electronics unit is defective.	Replace electronics.
HART communication is not working.	Missing or incorrectly installed communication resistor.	Install the communication resistor (250 Ω) correctly.
	Commubox is not properly connected.	Connect Commubox correctly .
	Commubox is not set to "HART".	Set Commubox selector switch to "HART".
Device measures incorrectly.	Configuration error	Check and correct parameter configuration (see below).

12.2 Diagnostic events

12.2.1 Diagnostic message

Faults detected by the self-monitoring system of the measuring device are displayed as a diagnostic message in alternation with the measured value display.

Status signals

The table (→  65) lists the messages that can occur. The ALARM STATUS parameter shows the message with the highest priority. The device has four different status information codes according to NE107:

F A0013956	"Failure" A device error has occurred. The measured value is no longer valid.
M A0013957	"Maintenance required" Maintenance is required. The measured value is still valid.
C A0013959	"Function check" The device is in service mode (e.g. during a simulation).
S A0013958	"Out of specification" The device is being operated: <ul style="list-style-type: none"> ▪ Outside its technical specifications (e.g. during warmup or cleaning processes). ▪ Outside the parameter configuration undertaken by the user (e.g. level outside of configured range)

Diagnostics event and event text

The fault can be identified by means of the diagnostic event. The event text helps you by providing information about the fault.

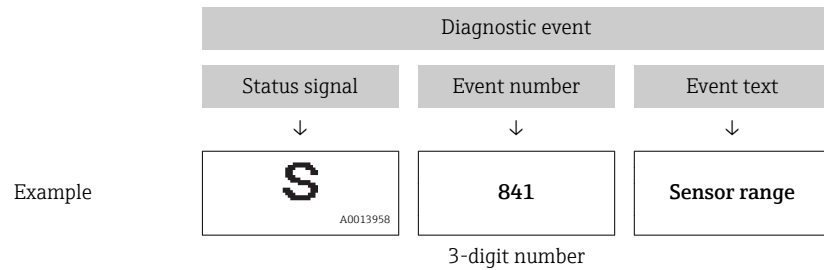

If two or more diagnostic events are pending simultaneously, only the message with the highest priority is shown. Other diagnostic messages that are pending can be viewed in the **Diagnostic list** submenu (→ ⓘ 93).

i Past diagnostic messages that are no longer pending are shown in the **Event logbook** submenu (→ ⓘ 94).

12.2.2 List of diagnostic events

General messages

Diagnostic event		Cause	Corrective measure
Code	Description		
0	No error	-	-

"F" messages

Diagnostic event		Cause	Corrective measure
Code	Description		
F002	Sens. unknown LP/HP	Sensor module does not suit the device (electronic sensor module nameplate).	Contact Endress+Hauser Service
F062	Sensor conn.	<ul style="list-style-type: none"> ▪ Electromagnetic effects are greater than specifications in the technical data. This message appears for a short time only. ▪ Sensor module defective. ▪ Cable connection between sensor module and main electronics disconnected. 	<ul style="list-style-type: none"> ▪ Contact Endress+Hauser Service ▪ Replace electronics ▪ Check the sensor module cable
F081	Initialization	<ul style="list-style-type: none"> ▪ Electromagnetic effects are greater than specifications in the technical data. This message appears for a short time only. ▪ Sensor module defective. ▪ Cable connection between sensor module and main electronics disconnected. 	<ul style="list-style-type: none"> ▪ Contact Endress+Hauser Service ▪ Check sensor cable ▪ Perform a reset
F083	Permanent mem. LP/HP	<ul style="list-style-type: none"> ▪ Electromagnetic effects outside the permitted range. This message appears for a short time only. ▪ Sensor module defective. 	<ul style="list-style-type: none"> ▪ Contact Endress+Hauser Service ▪ Restart the device
F140	Working range P LP/HP	<ul style="list-style-type: none"> ▪ Overpressure and low pressure present. ▪ Electromagnetic effects outside the permitted range. ▪ Sensor module defective. 	<ul style="list-style-type: none"> ▪ Check the process pressure ▪ Check sensor module range
F162	Sensor conn.	<ul style="list-style-type: none"> ▪ Sensor module defective (master). ▪ Electromagnetic effects outside the permitted range. This message appears for a short time only. 	<ul style="list-style-type: none"> ▪ Check sensor cable ▪ Replace sensor ▪ Contact Endress+Hauser Service

Diagnostic event		Cause	Corrective measure
Code	Description		
F162	Sensor conn. HP Sensor conn. LP	<ul style="list-style-type: none"> ▪ Electromagnetic effects outside the permitted range. This message appears for a short time only. ▪ Sensor module defective. 	<ul style="list-style-type: none"> ▪ Check sensor cable ▪ Replace sensor ▪ Contact Endress+Hauser Service
F163	Sensor conn.	<ul style="list-style-type: none"> ▪ Cable connection between sensor modules HP and LP interrupted. ▪ Sensor module defective (slave). ▪ Electromagnetic effects outside the permitted range. This message appears for a short time only. 	<ul style="list-style-type: none"> ▪ Restart the device ▪ Check the sensor module cable ▪ Contact Endress+Hauser Service
F164	Sensor sync.	<ul style="list-style-type: none"> ▪ The sensor modules cannot be synchronized with each other. ▪ Electromagnetic effects outside the permitted range. This message appears for a short time only. ▪ Sensor module(s) defective. 	<ul style="list-style-type: none"> ▪ Restart the device ▪ Replace sensor module ▪ Contact Endress+Hauser Service
F165	Sensor assignment	The assignment of the transmitter to sensor module LP or HP is unknown (e.g. after changing the sensor module). See also (→  70) "Replacement of sensor modules".	<ul style="list-style-type: none"> ▪ Connect transm. set. ▪ Restart the device ▪ Contact Endress+Hauser Service
F261	Electronics module	<ul style="list-style-type: none"> ▪ Main electronics defective. ▪ Fault in the main electronics. ▪ Sensor module defective. 	<ul style="list-style-type: none"> ▪ Restart the device ▪ Replace electronics
F282	Memory	<ul style="list-style-type: none"> ▪ Main electronics defective. ▪ Fault in the main electronics. 	<ul style="list-style-type: none"> ▪ Replace electronics ▪ Restart the device
F283	Memory content	<ul style="list-style-type: none"> ▪ Main electronics defective. ▪ Electromagnetic effects are greater than specifications in the technical data. ▪ The supply voltage is disconnected when writing. ▪ An error occurred when writing. 	<ul style="list-style-type: none"> ▪ Perform a reset ▪ Replace electronics
F411	Upload/download	<ul style="list-style-type: none"> ▪ The file is defective. ▪ During the download, the data are not correctly transmitted to the processor, e.g. because of open cable connections, spikes (ripple) on the supply voltage or electromagnetic effects. 	<ul style="list-style-type: none"> ▪ Repeat download ▪ Use other file ▪ Perform a reset
F510	Linearization	The linearization table is being edited.	<ul style="list-style-type: none"> ▪ Conclude entries ▪ Select "linear"
F511	Linearization	The linearization table consists of less than 2 points.	<ul style="list-style-type: none"> ▪ Table too small ▪ Correct table ▪ Accept the table
F512	Linearization	The linearization table is not monotonic increasing or decreasing.	<ul style="list-style-type: none"> ▪ Tab. not monotonic ▪ Correct table ▪ Accept the table
F841	Sensor range	<ul style="list-style-type: none"> ▪ Overpressure or low pressure present. ▪ Sensor module defective. 	<ul style="list-style-type: none"> ▪ Check the pressure value ▪ Contact Endress+Hauser Service
F882	Input signal	External measured value is not received or displays a failure status.	<ul style="list-style-type: none"> ▪ Check the bus ▪ Check source device ▪ Check the setting
F945	Pressure limit LP	<ul style="list-style-type: none"> ▪ The configured overpressure or underpressure limit of sensor module LP is exceeded. ▪ Sensor module LP defective. 	<ul style="list-style-type: none"> ▪ Check the pressure value ▪ Change pressure limit value ▪ Contact Endress+Hauser Service

"M" messages

Diagnostic event		Cause	Corrective measure
Code	Description		
M002	Sens. unknown	Sensor module does not suit the device (electronic sensor module nameplate). Device continues measuring.	Contact Endress+Hauser Service
M283	Memory content	<ul style="list-style-type: none"> ▪ Cause as indicated for F283. ▪ Correct measurement can continue as long as you do not need the peakhold indicator function. 	<ul style="list-style-type: none"> ▪ Perform a reset ▪ Replace electronics
M431	Adjustment	The calibration carried out would cause the nominal sensor module range to be exceeded or undershot.	<ul style="list-style-type: none"> ▪ Check the measuring range ▪ Check position adjustment ▪ Check the setting
M434	Scaling	<ul style="list-style-type: none"> ▪ Values for calibration (e.g. lower range value and upper range value) are too close together. ▪ Lower range value and/or upper range value undershoot or overshoot the sensor module range limits. ▪ The sensor module was replaced and the customer-specific configuration does not suit the sensor. ▪ Unsuitable download carried out. 	<ul style="list-style-type: none"> ▪ Check the measuring range ▪ Check the setting ▪ Contact Endress+Hauser Service
M438	Data record	<ul style="list-style-type: none"> ▪ The supply voltage is disconnected when writing. ▪ An error occurred when writing. 	<ul style="list-style-type: none"> ▪ Check the setting ▪ Restart the device ▪ Replace electronics

"C" messages

Diagnostic event		Cause	Corrective measure
Code	Description		
C412	Write Backup	Downloading.	Wait for download to complete.
C482	Simul. output	Simulation of the current output is switched on, i.e. the device is not measuring at present.	End the simulation
C484	Error simul.	Fault state simulation is switched on, i.e. the device is not measuring at present.	End the simulation
C824	Process pressure	<ul style="list-style-type: none"> ▪ Electromagnetic effects outside the permitted range. ▪ Overpressure or low pressure present. ▪ This message appears for a short time only. 	<ul style="list-style-type: none"> ▪ Check the pressure value ▪ Restart the device ▪ Perform a reset



"S" messages

Diagnostic event		Cause	Corrective measure
Code	Description		
S110	Operational range T	<ul style="list-style-type: none"> ▪ Electromagnetic effects outside the permitted range. ▪ Sensor module defective. 	<ul style="list-style-type: none"> ▪ Check the process pressure ▪ Check the temperature range
S140	Working range P LP/HP	<ul style="list-style-type: none"> ▪ Overpressure or low pressure present. ▪ Electromagnetic effects outside the permitted range. ▪ Sensor module defective. 	<ul style="list-style-type: none"> ▪ Check the process pressure ▪ Check the pressure value
S822	Process temp. LP/HP	<ul style="list-style-type: none"> ▪ The temperature measured in the sensor module is greater than the upper nominal temperature of the sensor module. ▪ The temperature measured in the sensor module is smaller than the lower nominal temperature of the sensor module. 	<ul style="list-style-type: none"> ▪ Check temperature ▪ Check the setting

Diagnostic event		Cause	Corrective measure
Code	Description		
S841	Sensor range	<ul style="list-style-type: none"> ▪ Overpressure or low pressure present. ▪ Sensor module defective. 	<ul style="list-style-type: none"> ▪ Check the pressure value ▪ Contact Endress+Hauser Service
S945	Pressure limit LP	<ul style="list-style-type: none"> ▪ The configured overpressure or underpressure limit of sensor module LP is exceeded. ▪ Sensor module LP defective. 	<ul style="list-style-type: none"> ▪ Check the pressure value ▪ Change pressure limit value ▪ Contact Endress+Hauser Service
S971	Adjustment	<ul style="list-style-type: none"> ▪ The current is outside the permitted range from 3.8 to 20.5 mA. ▪ The present pressure value is outside the configured measuring range (but within the sensor module range, if applicable). 	<ul style="list-style-type: none"> ▪ Check the pressure value ▪ Check the measuring range ▪ Check the setting

12.3 Response of output to errors

The behavior of the current output in case of fault is defined by the following parameters:

- "Alarm Behav. P (050)" (→  91)
- "Output fail mode (190)" (→  102)
- "High Alarm Curr. (052)" (→  91)

12.4 Firmware history

Date	Firmware version	Modifications	Documentation	
			Operating Instructions	Description of Device Parameters
01.2012	01.00.00	Original firmware. Can be operated using FieldCare from version 2.08.00	BA01044P/00/EN/01.12	GP01013P/00/EN/01.12
			BA01044P/00/EN/02.12	GP01013P/00/EN/02.12
			BA01044P/00/EN/03.12	GP01013P/00/EN/03.12
			BA01044P/00/EN/04.12	GP01013P/00/EN/04.12

12.5 Disposal

When disposing, separate and recycle the device components based on the materials.

13 Maintenance

No special maintenance work is required.

Keep the pressure compensation (only sensor modules) and GORE-TEX® filter (1) free from contamination.

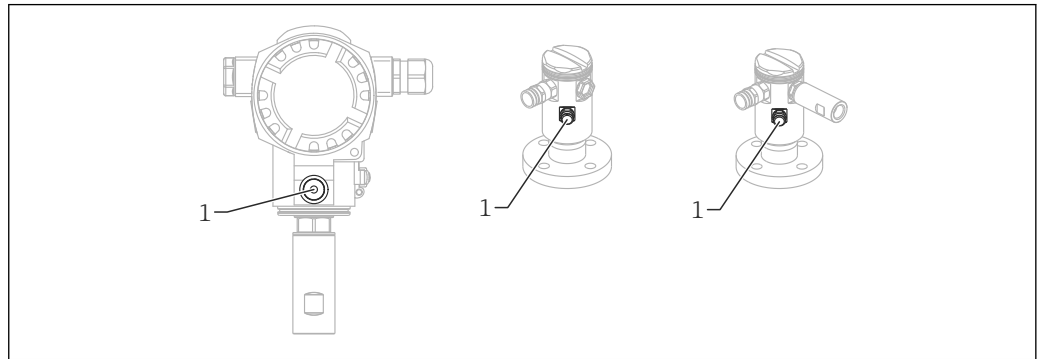

A0017750

13.1 Exterior cleaning

Please note the following points when cleaning the device:

- The cleaning agents used should not corrode the surface and the seals.
- Mechanical damage to the process isolating diaphragm, e.g. due to pointed objects, must be avoided.
- Observe the degree of protection of the device. See the nameplate if necessary (→  14).

14 Repair

14.1 General notes

14.1.1 Repair concept

The Endress+Hauser repair concept requires for devices to have a modular design and for repairs to be carried out by Endress+Hauser Service or by properly trained customers.

Spare parts are grouped into logical kits with the associated replacement instructions.

For more information on service and spare parts, please contact Endress+Hauser Service.

14.1.2 Repair of Ex-certified devices

When repairing Ex-certified devices, please also note the following:

- Only specialist personnel or Endress+Hauser-Service can carry out repairs to Ex certified devices.
- Relevant standards and national regulations as well as safety instructions (XA) and certificates must be observed.
- Only genuine Endress+Hauser spare parts may be used.
- When ordering spare parts, please check the device designation on the nameplate. Identical parts may only be used as replacements.
- Carry out repairs according to the instructions. Following a repair, the device must fulfill the requirements of the individual tests specified for that device.
- A certified device may be converted to another certified device version by Endress +Hauser Service only.
- All repairs and modifications must be documented.

14.1.3 Replacing sensor modules or main electronics

Once both sensor modules or the main electronics have been replaced, the sensor module that is connected to the transmitter must be selected. To do this, follow these steps:

1. Switch off the supply voltage
2. Replacing the sensor module or main electronics
3. Switch on the supply voltage.
4. Select sensor module LP or sensor module HP: Menu path: Expert → System → Management → Connect transm. (286)"

For additional information, see "Function" (→  12) section.

14.1.4 Replacing a device

Once a complete device has been replaced, the parameters can be transferred back into the device using FieldCare:

Prerequisite: The configuration of the old device was saved previously to the computer using FieldCare.

You can continue to measure without performing a new calibration.

14.2 Spare parts

- Some replaceable measuring device components are identified by means of a spare part nameplate. This contains information about the spare part.
- All the spare parts for the measuring device along with the order code are listed in the *W@M Device Viewer* (www.endress.com/deviceviewer) and can be ordered. If available, users can also download the associated Installation Instructions.



Measuring device serial number:

- Located on the device and spare part nameplate.
- Can be read out via the "Serial number" parameter in the "Instrument info" submenu.

15 Return





The measuring device must be returned if repairs or a factory calibration are required, or if the wrong measuring device has been ordered or delivered. According to legal regulations Endress+Hauser, as an ISO-certified company, is required to follow certain procedures when handling returned products that are in contact with the medium. To ensure swift, safe and professional device returns, please read the return procedures and conditions on the Endress+Hauser website at www.services.endress.com/return-material













- ▶ Select country.
 - ↳ The web site of the responsible sales office opens with all of the relevant information relating to returns.
- 1. If the desired country is not listed:
Click on the "Choose your location" link.
 - ↳ An overview of Endress+Hauser sales offices and representatives opens.
- 2. Contact your Endress+Hauser sales office or representative.



16 Overview of the operating menu





 Depending on the parameter configuration, not all submenus and parameters are available. Information on this can be found in the parameter description under "Prerequisite".









	Direct access	Description
Language	000	(→  78)









Display/operat.	Direct access	Description
Display mode	001	(→  78)
Value 2 display	002	(→  78)
Value 3 display	288	(→  106)
Format 1st Value	004	(→  79)
HART Input Form.	157	(→  100)











Setup	Direct access	Description
Operating mode	005 182	(→  79)
High Press. Side	183	(→  101)
Press. Eng. Unit	125	(→  99)
Corrected Press. (read only)	172	(→  101)
Pos. Zero Adjust	007	(→  80)
Empty Calib. ("Level" measuring mode and "Calibration Mode" = wet)	028 011	(→  80)
Full Calib. ("Level" measuring mode and "Calibration Mode" = wet)	031 012	(→  80)
Set LRV ("Pressure" measuring mode)	013	(→  81)
Set URV ("Pressure" measuring mode)	014	(→  81)
Damping switch (read only)	164	(→  100)
Damping value	017	(→  82)
Damping value (read only)	184	
Level before Lin ("Level" measuring mode)	019	(→  82)
Meas.Diff.Press. (read only)	020	(→  83)

Setup→	Extended Setup	Direct access	Description
	Code Definition	023	(→  84)
	Device tag	022	(→  84)
	Operator Code	021	(→  83)

Setup→	Extended Setup→	Level ("Level" measuring mode)	Direct access	Description
		Level Selection	024	(→  84)
		Unit before lin.	025	(→  85)
		Height Unit	026	(→  85)
		Calibration Mode	027	(→  85)

Setup→	Extended Setup→	Level ("Level" measuring mode)	Direct access	Description
		Empty Calib. Empty Calib. (read only)	028 011	(→  86)
		Empty Pressure Empty Pressure (read only)	029 185	(→  86)
		EMPTY HEIGHT Empty height (read only)	030 186	(→  87)
		Full Calib. Full Calib. (read only)	031 012	(→  87)
		FULL PRESSURE Full Pressure (read only)	032 187	(→  87)
		FULL HEIGHT Full height (read only)	033 188	(→  88)
		Adjust Density	034	(→  88)
		Process Density	035	(→  88)
		Level Before Lin (read only)	019	(→  82)

Setup→	Extended Setup→	Linearization	Direct access	Description
		Lin. mode	037	(→  89)
		Unit after lin.	038	(→  89)
		Line number	039	(→  89)
		X-value.: (edit mode) X-value: (semi-automatic) X-value: (read only)	040 193 123	(→  90)
		Y-val: (edit mode) Y-val: (semi-automatic) Y-val: (read only)	041 041 194	(→  90)
		Edit table	042	(→  90)
		TANK DESCRIPTION	173	(→  101)
		Tank Content (read only)	043	(→  91)

Setup→	Extended Setup→	Current output	Direct access	Description
		Alarm Behav. P	050	(→  91)
		Alarm cur.switch (read only)	165	(→  101)
		Output fail mode Output fail mode (read only)	190 051	(→  102)
		High Alarm Curr.	052	(→  91)
		Set Min. Current	053	(→  92)
		Output current (read only)	054	(→  92)
		Get LRV (only "Pressure")	015	(→  81)
		Set LRV	013	(→  81)
		Get URV (only "Pressure")	016	(→  82)
		Set URV	014	(→  81)

Diagnosics	Direct access	Description
Diagnostic Code (read only)	071	(→ ⓘ 92)
Last Diag. Code (read only)	072	(→ ⓘ 92)

Diagnosics →	Sensor HP	Direct access	Description
	Min. Meas.Press. (read only)	073	(→ ⓘ 93)
	Counter P < Pmin (read only)	262	(→ ⓘ 102)
	Max. Meas.Press. (read only)	074	(→ ⓘ 93)
	Counter P > Pmax (read only)	263	(→ ⓘ 102)
	Min. Meas.Temp. (read only)	264	(→ ⓘ 103)
	Max. Meas.Temp. (read only)	265	(→ ⓘ 103)

Diagnosics →	Sensor LP	Direct access	Description
	Min. Meas.Press. (read only)	266	(→ ⓘ 103)
	Counter P < Pmin (read only)	267	(→ ⓘ 103)
	Max. Meas.Press. (read only)	268	(→ ⓘ 104)
	Counter P > Pmax (read only)	269	(→ ⓘ 104)
	Min. Meas.Temp. (read only)	270	(→ ⓘ 104)
	Max. Meas.Temp. (read only)	271	(→ ⓘ 104)

Diagnosics →	Diagnosics list	Direct access	Description
	Diagnostic 1 (read only)	075	(→ ⓘ 93)
	Diagnostic 2 (read only)	076	(→ ⓘ 93)
	Diagnostic 3 (read only)	077	(→ ⓘ 93)
	Diagnostic 4 (read only)	078	(→ ⓘ 93)
	Diagnostic 5 (read only)	079	(→ ⓘ 93)
	Diagnostic 6 (read only)	080	(→ ⓘ 93)
	Diagnostic 7 (read only)	081	(→ ⓘ 93)
	Diagnostic 8 (read only)	082	(→ ⓘ 93)
	Diagnostic 9 (read only)	083	(→ ⓘ 93)
	Diagnostic 10 (read only)	084	(→ ⓘ 93)

Diagnosics →	Event logbook	Direct access	Description
	Last Diag. 1 (read only)	085	(→ ⓘ 94)
	Last Diag. 2 (read only)	086	(→ ⓘ 94)
	Last Diag. 3 (read only)	087	(→ ⓘ 94)
	Last Diag. 4 (read only)	088	(→ ⓘ 94)
	Last Diag. 5 (read only)	089	(→ ⓘ 94)
	Last Diag. 6 (read only)	090	(→ ⓘ 94)
	Last Diag. 7 (read only)	091	(→ ⓘ 94)
	Last Diag. 8 (read only)	092	(→ ⓘ 94)
	Last Diag. 9 (read only)	093	(→ ⓘ 94)
	Last Diag. 10 (read only)	094	(→ ⓘ 94)

Diagnosics→	Device info	Direct access	Description
	Firmware Version (read only)	095	(→ ⓘ 94)
	Serial Number (read only)	096	(→ ⓘ 94)
	Ext. Order Code (read only)	097	(→ ⓘ 94)
	Order Code (read only)	098	(→ ⓘ 95)
	Cust. tag number	254	(→ ⓘ 102)
	Device tag	022	(→ ⓘ 84)
	ENP Version (read only)	099	(→ ⓘ 95)
	Config Counter (read only)	100	(→ ⓘ 95)
	Manufacturer ID (read only)	103	(→ ⓘ 96)
	Device ID (read only)	279	(→ ⓘ 105)
	Device Revision (read only)	108	(→ ⓘ 96)

Diagnosics→	Device info→	Sens. Limit HP	Direct access	Description
		LRL Sensor (read only)	101	(→ ⓘ 95)
		URL Sensor (read only)	102	(→ ⓘ 96)



Diagnosics→	Device info→	Sens. Limit LP	Direct access	Description
		LRL Sensor (read only)	272	(→ ⓘ 104)
		URL Sensor (read only)	273	(→ ⓘ 105)

Diagnosics→	Measured values	Direct access	Description
	Level Before Lin (read only)	019	(→ ⓘ 82)
	Tank Content (read only)	043	(→ ⓘ 91)
	Meas.Diff.Press. (read only)	020	(→ ⓘ 83)
	Sensor Press. HP (read only)	109	(→ ⓘ 96)
	Sensor Press. LP (read only)	280	(→ ⓘ 105)
	Meas. Press. HP (read only)	281	(→ ⓘ 105)
	Meas. Press. LP (read only)	282	(→ ⓘ 105)
	Corrected Press. (read only)	172	(→ ⓘ 101)
	Sensor Temp. HP (read only)	110	(→ ⓘ 96)
	Sensor Temp. LP (read only)	283	(→ ⓘ 106)



Diagnosics→	Simulation	Direct access	Description
	Simulation mode	112	(→ ⓘ 97)
	Sim. diff.press.	113	(→ ⓘ 98)
	Sim. Press. HP	284	(→ ⓘ 106)
	Sim. Press. LP	285	(→ ⓘ 106)
	Sim. level	115	(→ ⓘ 98)
	Sim. tank cont.	116	(→ ⓘ 98)
	Sim. Current	117	(→ ⓘ 99)
	Sim. error no.	118	(→ ⓘ 99)

Diagnostics→	Reset	Direct access	Description
	Reset	124	(→ 📄 99)



17 Description of device parameters

- 
 - : Indicates how to navigate to the parameter using the display and operating module
 - : Indicates how to navigate to the parameter using operating tools (e.g. FieldCare)



Language (000)

Navigation	  Main menu → Language
Write permission	Operators/Service engineers/Expert
Description	Select the menu language for the local display.
Options	<ul style="list-style-type: none"> ▪ English ▪ Another language (as selected when ordering the device) ▪ Possibly a third language (language of the manufacturing plant)
Factory setting	English

Display mode (001)

Navigation	  Display/operat. → Display mode (001)
Write permission	Operators/Service engineers/Expert
Description	Specify the contents for the first line of the local display in measuring mode.
Options	<ul style="list-style-type: none"> ▪ Primary value ▪ External value ▪ All alternating
Factory setting	Primary value

2nd disp. value (002)

Navigation	  Display/operat. → 2nd disp. value (002)
Write permission	Operators/Service engineers/Expert
Description	Specify the contents for the second value in the alternating display mode in measuring mode.

Options	<ul style="list-style-type: none"> ■ No value ■ Differential pressure ■ Pressure HP ■ Pressure LP ■ Sensor Temp. HP ■ Sensor Temp. LP ■ Level before linearization ■ Current ■ Main measured value (%) <p>The options depend on the measuring mode chosen.</p>
Factory setting	No value

Format 1st Value (004)

Navigation	 Display/operat. → Format 1st Value (004)
Write permission	Operators/Service engineers/Expert
Description	Specify the number of places after the decimal point for the value displayed in the main line.
Options	<ul style="list-style-type: none"> ■ Auto ■ x ■ x.x ■ x.xx ■ x.xxx ■ x.xxxx ■ x.xxxxx
Factory setting	Auto

Measuring mode (005/182)



Navigation	 Setup → Measuring Mode (005/182)
Write permission	Operators/Service engineers/Expert
Description	Select the measuring mode. The operating menu is structured differently depending on the measuring mode selected.
Options	<ul style="list-style-type: none"> ■ Pressure ■ Level
Factory setting	Level or according to order specifications

⚠ WARNING**Changing the measuring mode affects the span (URV)**



This situation can result in product overflow.

- ▶ If the measuring mode is changed, the setting for the span (URV) must be checked in the "Setup" operating menu and readjusted if necessary.



Pos. Zero Adjust (007)

Navigation	  Setup → Pos. Zero Adjust (007)
Write permission	Operators/Service engineers/Expert
Description	Position adjustment – the pressure difference between zero (set point) and the measured pressure need not be known.
Example	<ul style="list-style-type: none"> ▪ Measured value = 2.2 mbar (0.033 psi) ▪ You correct the measured value via the "Pos. Zero Adjust" parameter with the "Confirm" option. This means that you are assigning the value 0.0 to the pressure present. ▪ Measured value (after pos. zero adjust) = 0.0 mbar ▪ The current value is also corrected.
Options	<ul style="list-style-type: none"> ▪ Confirm ▪ Cancel
Factory setting	Cancel





Empty Calib. (011/28)

Navigation	  Setup → Empty Calib. (011/028)
Write permission	Operators/Service engineers/Expert
Description	Enter the output value for the lower calibration point (vessel empty). The unit defined in "Unit Before Lin." must be used.
Note	<ul style="list-style-type: none"> ▪ In the case of wet calibration, the level (vessel empty) must actually be available. The associated pressure is then automatically recorded by the device. ▪ In the case of dry calibration, the level (vessel empty) does not have to be available. The associated pressure has to be entered in the "Empty Pressure (029)" parameter for the "In pressure" level selection. The associated height has to be entered in the "Empty height" (030) parameter for the "In height" level selection.
Factory setting	0.0





Full Calib. (012/031)

Navigation	  Setup → Full Calib. (012/031)
Write permission	Operators/Service engineers/Expert
Description	Enter the output value for the upper calibration point (vessel full). The unit defined in "Unit Before Lin." must be used.
Note	<ul style="list-style-type: none"> ■ In the case of wet calibration, the level (vessel full) must actually be available. The associated pressure is then automatically recorded by the device. ■ In the case of dry calibration, the level (vessel full) does not have to be available. The associated pressure has to be entered in the "Full Pressure" parameter for the "In pressure" level selection. The associated height has to be entered in the "Full height" parameter for the "In height" level selection.
Factory setting	100.0



Set LRV (013, 056, 166, 168)

Navigation	  Setup → Set LRV (013, 056, 166, 168)   Setup → Advanced Setup → Current Output → Set LRV (013, 056, 166, 168)
Write permission	Operators/Service engineers/Expert
Description	Set the pressure value, level or content for the lower current value (4 mA).
Factory setting	<ul style="list-style-type: none"> ■ 0.0 % in Level measuring mode ■ 0.0 mbar/bar or in accordance with ordering information in Pressure measuring mode

Set URV (014, 057, 167, 169)



Navigation	  Setup → Set URV (014, 057, 167, 169)   Setup → Advanced Setup → Current output → Set URV (014, 057, 167, 169)
Write permission	Operators/Service engineers/Expert
Description	Set the pressure value, level or content for the upper current value (20 mA).
Factory setting	<ul style="list-style-type: none"> ■ 100.0 % in Level measuring mode ■ URL Sensor or according to ordering information in Pressure measuring mode

Get LRV (015)



Navigation	  Setup → Advanced Setup → Current Output → Get LRV (015)
Write permission	Operators/Service engineers/Expert

Description	Setting lower range value. The pressure for the lower current value (4 mA) is present at the device. Use the "Confirm" option to assign the lower current value to the applied pressure value.
Prerequisite	Pressure measuring mode
Options	<ul style="list-style-type: none"> ■ Cancel ■ Confirm
Factory setting	Cancel

Get URV (016)

Navigation	  Setup → Advanced Setup → Current Output → Get URV (016)
Write permission	Operators/Service engineers/Expert
Description	Setting upper range value. The pressure for the upper current value (20 mA) is present at the device. Use the "Confirm" option to assign the applied pressure value to the upper current value.
Prerequisite	Pressure measuring mode
Options	<ul style="list-style-type: none"> ■ Cancel ■ Confirm
Factory setting	Cancel

Damping (017)/(184)

Navigation	  Setup → Damping (017)/(184)
Write permission	Operators/Service engineers/Expert (if the "Damping" DIP switch is set to "on")
Description	Enter damping time (time constant τ) ("Damping" DIP switch set to "on") Display damping time (time constant τ) ("Damping" DIP switch set to "off"). The damping affects the speed at which the measured value reacts to changes in pressure.
Input range	0.0 to 999.0 s
Factory setting	2.0 sec. or according to order specifications

Level before lin. (019)

Navigation

- 📄📄 Setup → Level Before Lin. (019)
- 📄📄 Setup → Advanced Setup → Level → Level Before Lin. (019)
- 📄📄 Diagnosis → Measured Values → Level Before Lin. (019)

Write permission

No write permissions. Parameter is read only.

Description

Displays the level value prior to linearization.

Meas.Diff.Press. (020)

Navigation

- 📄📄 Setup → Meas.Diff.Press. (020)
- 📄📄 Diagnosis → Measured Values → Meas.Diff.Press. (020)

Write permission

No write permissions. Parameter is read only.

Description

Displays the measured differential pressure after sensor trim, position adjustment and damping.

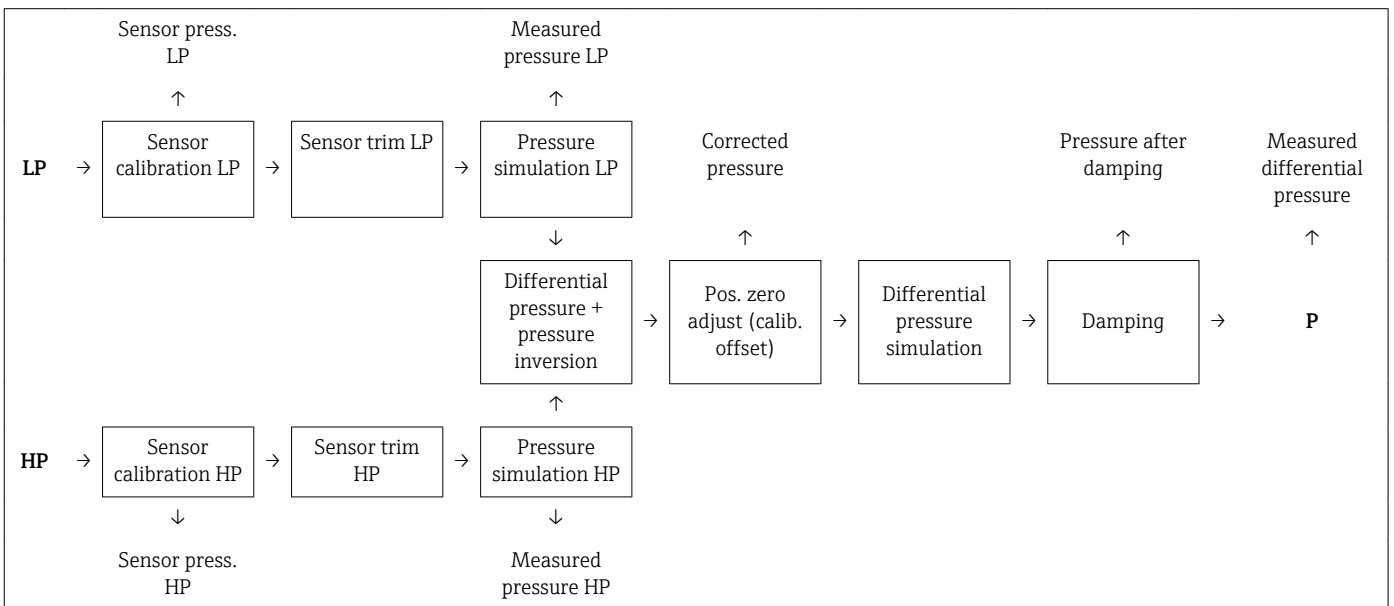

Operator Code (021)

Navigation

- 📄📄 Setup → Advanced Setup → Operator Code (021)

Write permission

Operators/Service engineers/Expert

Description

Use this function to enter a code to lock or unlock operation.

User entry

- To lock: Enter a number ≠ the release code (value range: 1 to 9999).
- To unlock: Enter the release code.

Note The release code is "0" in the order configuration. Another release code can be defined in the "Code Definition" parameter. If the user has forgotten the release code, the release code can be visible by entering the number "5864".

Factory setting 0

Device tag (022)



Navigation   Setup → Advanced Setup → Device tag (022)

Write permission Operators/Service engineers/Expert

Description Enter the device tag, e.g. TAG number (max. 32 alphanumeric characters).

Factory setting No entry or according to order specifications

Code Definition (023)

Navigation   Setup → Advanced Setup → Code Definition (023)



Write permission Operators/Service engineers/Expert

Description Use this function to enter a release code with which the device can be unlocked.

Options A number from 0 to 9999

Factory setting 0

Level Selection (024)

Navigation   Setup → Advanced Setup → Level → Level Selection (024)

Write permission Operators/Service engineers/Expert



Description Select the method for calculating the level

Options



- In pressure
If this option is selected, specify two pressure/level value pairs. The level value is displayed directly in the unit that you select via the "Unit Before Lin." parameter.
- In height
If this option is selected, specify two height/level value pairs. From the measured pressure, the device first calculates the height using the density. This information is then used to calculate the level in the "Unit Before Lin." selected using the two value pairs specified.

Factory setting In pressure



Unit before lin. (025)

Navigation	  Setup → Advanced Setup → Level → Unit Before Lin. (025)
Write permission	Operators/Service engineers/Expert
Description	Select the unit for the measured value display for the level before linearization.
Example	<ul style="list-style-type: none"> ■ Current measured value: 0.3 ft ■ New output unit: m ■ New measured value: 0.3 m
Options	<ul style="list-style-type: none"> ■ % ■ mm, cm, dm, m ■ ft, in ■ m³, in³ ■ l, hl ■ ft³ ■ gal, lgal ■ kg, t ■ lb
Note	The unit selected is only used to describe the measured value. This means that when selecting a new output unit, the measured value is not converted.
Factory setting	%



Height unit (026)

Navigation	  Setup → Advanced Setup → Level → Height Unit (026)
Write permission	Operators/Service engineers/Expert
Description	Select the height unit. The measured pressure is converted to the selected height unit using the "Adjust Density" parameter.
Prerequisite	"Level Selection" = "In height"
Options	<ul style="list-style-type: none"> ■ mm ■ m ■ in ■ ft
Factory setting	m



Calibration mode (027)

Navigation	  Setup → Advanced Setup → Level → Calibration Mode (027)
Write permission	Operators/Service engineers/Expert
Description	Select the calibration mode.
Options	<ul style="list-style-type: none"> ■ Wet Wet calibration takes place by filling and emptying the vessel. In the case of two different levels, the level, volume, mass or percentage value entered is assigned to the pressure measured at this point in time ("Empty Calib." and "Full Calib." parameters). ■ Dry Dry calibration is a theoretical calibration. For this calibration, you specify two pressure-level value pairs or height-level value pairs via the following parameters: "Empty Calib.", "Empty Pressure", "Empty Height", "Full Calib.", "Full Pressure", "Full Height".
Factory setting	Wet



Empty Calib. (028)/(011)

Navigation	  Setup → Advanced Setup → Level → Empty Calib. (028)/(011)
Write permission	Operators/Service engineers/Expert
Description	Enter the output value for the lower calibration point (vessel empty). The unit defined in "Unit Before Lin." must be used.
Note	<ul style="list-style-type: none"> ■ In the case of wet calibration, the level (vessel empty) must actually be available. The associated pressure is then automatically recorded by the device. ■ In the case of dry calibration, the level (vessel empty) does not have to be available. The associated pressure has to be entered in the "Empty Pressure (029)" parameter for the "In pressure" level selection. The associated height has to be entered in the "Empty height" (030) parameter for the "In height" level selection.
Factory setting	0.0



Empty Pressure (029)/(185)

Navigation	  Setup → Advanced Setup → Level → Empty Pressure (029)/(185)
Write permission	Operators/Service engineers/Expert
Description	Enter the pressure value for the lower calibration point (vessel empty). See also "Empty Calib. (028)".
Prerequisite	<ul style="list-style-type: none"> ■ "Level Selection" = In pressure ■ "Calibration mode" = Dry -> entry ■ "Calibration mode" = Wet -> display
Factory setting	0.0



Empty height (030)/(186)

Navigation	  Setup → Advanced Setup → Level → Empty Height (030)/(186)
Write permission	Operators/Service engineers/Expert
Description	Enter the height value for the lower calibration point (vessel empty). The unit is selected via the "Height unit (026)" parameter.
Prerequisite	<ul style="list-style-type: none"> ■ "Level Selection" = "In height" ■ "Calibration mode" = Dry -> entry ■ "Calibration mode" = Wet -> display
Factory setting	0.0



Full Calib. (031)/(012)

Navigation	  Setup → Advanced Setup → Level → Full Calib. (031)/(012)
Write permission	Operators/Service engineers/Expert
Description	Enter the output value for the upper calibration point (vessel full). The unit defined in "Unit Before Lin." must be used.
Note	<ul style="list-style-type: none"> ■ In the case of wet calibration, the level (vessel full) must actually be available. The associated pressure is then automatically recorded by the device. ■ In the case of dry calibration, the level (vessel full) does not have to be available. The associated pressure has to be entered in the "Full Pressure" parameter for the "In pressure" level selection. The associated height has to be entered in the "Full height" parameter for the "In height" level selection.
Factory setting	100.0



Full Pressure (032)/(187)

Navigation	  Setup → Advanced Setup → Level → Full Pressure (032)/(187)
Write permission	Operators/Service engineers/Expert
Description	Enter the pressure value for the upper calibration point (vessel full). See also "Full Calib.".
Prerequisite	<ul style="list-style-type: none"> ■ "Level Selection" = In pressure ■ "Calibration mode" = Dry -> entry ■ "Calibration mode" = Wet -> display
Factory setting	URL of the sensor module



Full height (033)/(188)

Navigation	  Setup → Advanced Setup → Level → Full height (033)/(188)
Write permission	Operators/Service engineers/Expert
Description	Enter the height value for the upper calibration point (vessel full). The unit is selected via the "Height unit" parameter.
Prerequisite	<ul style="list-style-type: none"> ■ "Level Selection" = "In height" ■ "Calibration mode" = Dry -> entry ■ "Calibration mode" = Wet -> display
Factory setting	URL is converted to a level unit



Adjust density (034)

Navigation	  Setup → Advanced Setup → Level → Adjust Density (034)
Write permission	Operators/Service engineers/Expert
Description	Enter the density of the medium used to perform the calibration. The measured pressure is converted to a height using the "Height unit" and "Adjust Density" parameters.
Factory setting	1.0



Process Density (035)

Navigation	  Setup → Advanced Setup → Level → Process Density (035)
Write permission	Operators/Service engineers/Expert
Description	Enter a new density value for density correction. The calibration was carried out with the medium water, for example. Now the vessel is to be used for another medium with another density. The calibration is corrected appropriately by entering the new density value in the "Process Density" parameter.
Note	If you change to dry calibration after completing a wet calibration using the "Calibration mode" parameter, the density for the "Adjust Density" and "Process Density" parameters must be entered correctly before changing the calibration mode.
Factory setting	1.0

Lin. mode (037)

Navigation	  Setup → Advanced Setup → Linearization → Lin. Mode (037)
Write permission	Operators/Service engineers/Expert
Description	Select the linearization mode.
Options	<ul style="list-style-type: none"> ■ Linear The level is output without being converted beforehand. "Level before Lin" is output. ■ Erase table The existing linearization table is deleted. ■ Manual entry (sets the table to edit mode, an alarm is output): The value pairs of the table (X-value (193/040) and Y-val. (041)) are entered manually. ■ Semi-automatic entry (sets the table to edit mode, an alarm is output): The vessel is emptied or filled in stages in this entry mode. The device automatically records the level value (X-value (193/040)). The associated volume, mass or % value is entered manually (Y-val (041)). ■ Activate table The table entered is activated and checked with this option. The device shows the level after linearization.
Factory setting	Linear

Unit after lin. (038)



Navigation	  Setup → Advanced Setup → Linearization → Unit After Lin. (038)
Write permission	Operators/Service engineers/Expert
Description	Select volume unit, mass, height or % (unit of the Y-val).
Options	<ul style="list-style-type: none"> ■ % ■ cm, dm, m, mm ■ hl ■ in³, ft³, m³, ■ l ■ in, ft ■ kg, t ■ lb ■ gal ■ lgal
Factory setting	%

Line numb. (039)



Navigation	  Setup → Advanced Setup → Linearization → Line-numb. (039)
-------------------	---

Write permission	Operators/Service engineers/Expert
Description	Enter the number of the current point in the table. The subsequent entries in "X-value" and "Y-val." refer to this point.
Input range	1...32



X-value (040)/(123)/(193)

Navigation	  Setup → Advanced Setup → Linearization → X-value (040)/(123)/(193)
Write permission	Operators/Service engineers/Expert
Description	Enter the X-value (level before linearization) for the specific point in the table and confirm.
Note	<ul style="list-style-type: none"> ▪ If "Lin. mode" = "Manual", the level value must be entered. ▪ If "Lin. mode" = "Semiautomatic", the level value is displayed and has to be confirmed by entering the paired Y-val.

Y-val (041)/(194)

Navigation	  Setup → Advanced Setup → Linearization → Y-val (041)/(194)
Write permission	Operators/Service engineers/Expert
Description	Enter the Y-val (value after linearization) for the specific point in the table. The unit is determined by "Unit after lin."
Note	The linearization table must be monotonic (increasing or decreasing).

Edit table (042)

Navigation	  Setup → Advanced Setup → Linearization → Edit Table (042)
Write permission	Operators/Service engineers/Expert
Description	Select the function for entering the table.
Options	<ul style="list-style-type: none"> ▪ Next point: enter the next point. ▪ Current point: stay on the current point to correct a mistake for example. ▪ Last input point: skip back to previous point to correct a mistake for example. ▪ Insert point: insert an additional point (see example below). ▪ Delete point: delete the current point (see example below).

Example**Add point, in this case between the 4th and 5th point for example**

- Select point 5 via the "Line-numb." parameter.
- Select the "Insert point" option via the "Edit table" parameter.
- Point 5 is displayed for the "Line-numb" parameter. Enter new values for the "X-value" and "Y-val." parameters.

Delete point, in this case the 5th point for example



- Select point 5 via the "Line-numb." parameter.
- Select the "Delete point" option via the "Edit table" parameter.
- The 5th point is deleted. All of the following points are pushed up one number i.e. following deletion, the 6th point becomes Point 5.

Factory setting

Current point

Tank content (043)

Navigation

 Setup → Advanced Setup → Linearization → Tank Content (043)
 Diagnosis → Measured values → Tank Content (043)

Write permission

Operators/Service engineers/Expert

Description

Displays the level value after linearization.

Alarm Behav. P (050)

Navigation Setup → Advanced Setup → Current output → Alarm Behav. P (050)**Write permission**

Operators/Service engineers/Expert

Description

Set current output if sensor module limits are overshoot or undershoot.



Options

- Warning
The device continues to measure. An error message is displayed.
- Alarm
The output signal assumes a value that can be defined by the "Output fail mode (190)/(051)" function.
- Special
 - The lower sensor module limit is undershoot (sensor module LP or HP or complete system):
Current output = 3.6 mA
 - The upper sensor module limit is overshoot (sensor module LP or HP or complete system):
Current output assumes a value of 21 - 23 mA, depending on the setting of the "High Alarm Curr." parameter (052).



Factory setting

Warning



High Alarm Curr. (052)

Navigation	  Setup → Advanced Setup → Current Output → High Alarm Curr. (052)
Write permission	Operators/Service engineers/Expert
Description	Enter the current value for maximum alarm current. See also "Output fail mode".
Input range	21 to 23 mA
Factory setting	22 mA



Set Min. Current (053)

Navigation	  Setup → Advanced Setup → Current Output → Set Min. Current (053)
Write permission	Operators/Service engineers/Expert
Description	Enter lower current limit. Some switching units accept no current smaller than 4.0 mA.
Options	<ul style="list-style-type: none"> ■ 3.8 mA ■ 4.0 mA
Factory setting	3.8 mA



Output current (054)

Navigation	  Setup → Advanced Setup → Current Output → Output Current (054)
Write permission	Operators/Service engineers/Expert
Description	Displays the current current value.



ALARM STATUS (071)

Navigation	  Diagnosis → Diagnostic Code (071)
Write permission	No write permissions. Parameter is read only.
Description	Displays the diagnostic message with the highest priority currently present.



Last diag. code (072)

Navigation	  Diagnosis → Last Diag. Code (072)
Write permission	No write permissions. Parameter is read only.
Description	Displays the last diagnostic message that occurred and was rectified.
Note	<ul style="list-style-type: none"> ▪ Digital communication: the last message is displayed. ▪ Use the "Reset logbook" parameter to clear the messages listed in the parameter "Last diag. code".



Min. meas. press. (073)

Navigation	  Diagnosis → Sensor HP → Minimum Pressure (073)
Write permission	No write permissions. Parameter is read only.
Description	Displays the lowest pressure value measured (peakhold indicator). You can reset this indicator by means of the "Reset peakhold" parameter.

Max. meas. press. (074)

Navigation	  Diagnosis → Sensor HP → Maximum Pressure (074)
Write permission	No write permissions. Parameter is read only.
Description	Displays the highest pressure value measured (peakhold indicator). You can reset this indicator by means of the "Reset peakhold" parameter.
	Diagnostic list

Diagnostic 1 (075)
Diagnostic 2 (076)
Diagnostic 3 (077)
Diagnostic 4 (078)
Diagnostic 5 (079)
Diagnostic 6 (080)
Diagnostic 7 (081)
Diagnostic 8 (082)
Diagnostic 9 (083)
Diagnostic 10 (084)

Navigation	  Diagnosis → Diagnostic list
Write permission	No write permissions. Parameter is read only.
Description	This parameter contains up to ten diagnosis messages that are currently pending, arranged in order of priority.

Event logbook

Last diag. 1 (085)
 Last diag. 2 (086)
 Last diag. 3 (087)
 Last diag. 4 (088)
 Last diag. 5 (089)
 Last diag. 6 (090)
 Last diag. 7 (091)
 Last diag. 8 (092)
 Last diag. 9 (093)
 Last diag. 10 (094)

Navigation  Diagnosis → Event Logbook

Write permission No write permissions. Parameter is read only.

Description This parameter contains the last 10 diagnosis messages to occur and be rectified. They can be reset using the "Reset logbook" parameter. Errors which have occurred multiple times are displayed once only. Errors may also appear multiple times if another error has occurred in the meantime. The messages are displayed in chronological order.

Firmware version (095)

Navigation  Diagnosis → Instrument info → Firmware Version (095)

Write permission No write permissions. Parameter is read only.

Description Displays the firmware version.

Serial number (096)

Navigation  Diagnosis → Instrument info → Serial Number (096)

Write permission Parameter is read only. Only Endress+Hauser Service has write permission.

Description Displays the serial number of the device (11 alphanumeric characters).

Ext. order code (097)

Navigation  Diagnosis → Instrument info → Ext. Order Code (097)

Write permission Parameter is read only. Only Endress+Hauser Service has write permission.

Description Displays extended order number.

Factory setting According to order specifications

Order code (098)

Navigation  Diagnosis → Instrument info → Order Code (098)

Write permission Parameter is read only. Only Endress+Hauser Service has write permission.

Description Displays the order identifier.

Factory setting According to order specifications

ENP version (099)

Navigation  Diagnosis → Instrument info → ENP Version (099)

Write permission Operators/Service engineers/Expert

Description Displays the ENP version
(ENP = electronic nameplate)

Config. counter (100)

Navigation  Diagnosis → Instrument info → Config. Counter (100)

Write permission Operators/Service engineers/Expert

Description Displays the configuration counter.
This counter is increased by one every time a parameter or group is changed. The counter counts up to 65535 and then starts again at zero.



LRL sensor (101)

Navigation  Diagnosis → Instrument info → Sens. Limit HP → LRL Sensor (101)



Write permission No write permissions. Parameter is read only.

Description Displays the lower-range limit of the sensor module.



URL sensor (102)

Navigation	  Diagnosis → Instrument info → Sens. Limit HP → URL sensor (102)
Write permission	No write permissions. Parameter is read only.
Description	Displays the upper-range limit of the sensor module.



Manufacturer ID (103)

Navigation	  Diagnosis → Instrument info → Manufacturer ID (103)
Write permission	No write permissions. Parameter is read only.
Description	Displays the HART manufacturer ID in a decimal digit format. Here: 17



Device revision (108)

Navigation	  Diagnosis → Instrument info → Device Revision (108)
Write permission	No write permissions. Parameter is read only.
Description	Display of Device Revision (e.g. 1)

Sensor pressure HP (109)



Navigation	  Diagnosis → Measured Values → Sensor Press. HP (109)
Write permission	No write permissions. Parameter is read only.
Description	Displays the measured pressure before the sensor trim.

Sensor Temp. HP (110)

Navigation	  Diagnosis → Measured values → Sensor Temp. HP (110)
Write permission	No write permissions. Parameter is read only.

Description Displays the temperature currently measured in the sensor module. This can deviate from the process temperature.

Simulation mode (112)

Navigation   Diagnosis → Simulation → Simulation mode (112)

Write permission Operators/Service engineers/Expert

Description Switch on simulation and select the simulation mode. When changing the measuring mode or the level type (Lin. Mode (037)) or when the device is restarted, any simulation running is switched off.

- Options**
- None
 - Differential pressure, → see this table, "Sim. pressure" parameter
 - Level, → see this table, "Sim. level" parameter
 - Press. HP, → see this table, "Sim. Press. HP" parameter
 - Press. LP, → see this table, "Sim. Press. LP" parameter
 - Tank content, → see this table, Sim. tank cont." parameter
 - Current, → see this table, "Sim. Current" parameter
 - Alarm/warning, → see this table, "Sim. error no."

Factory setting None

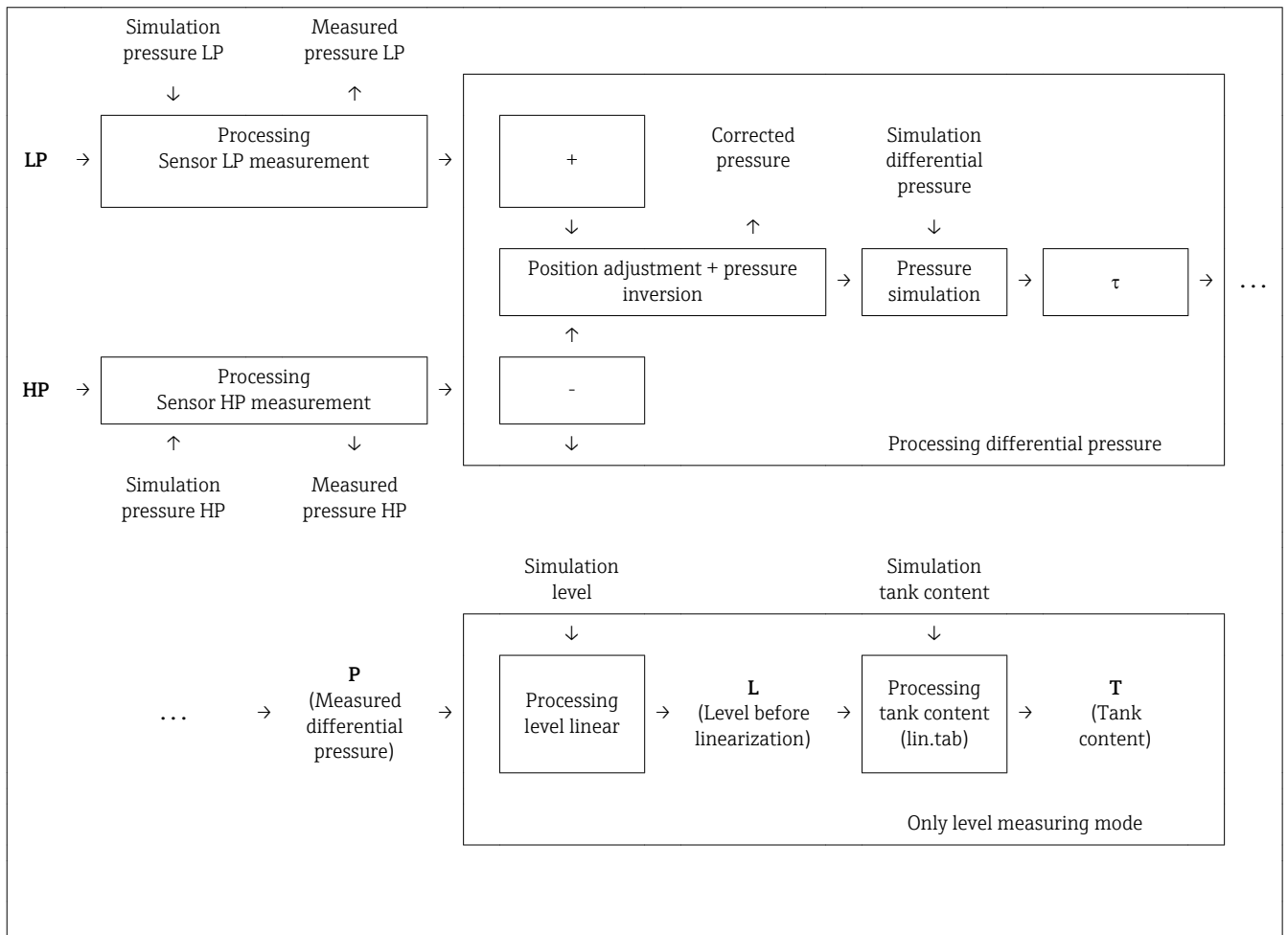

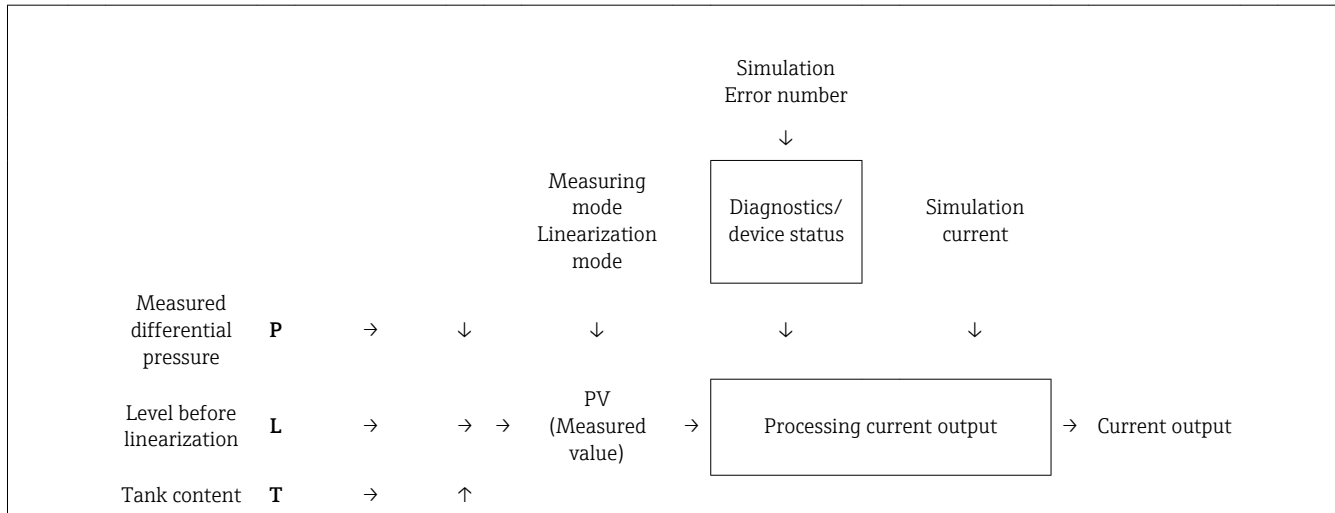

Sim. diff.press. (113)

Navigation	Diagnosis → Simulation → Sim.diff.press. (113)
Write permission	Operators/Service engineers/Expert
Description	Enter the simulation value. See also "Simulation Mode".
Prerequisite	"Simulation mode" = Differential pressure
Value at switch-on	Current differential pressure measured value

Sim. level (115)



Navigation	Diagnosis → Simulation → Sim. level (115)
Write permission	Operators/Service engineers/Expert
Description	Enter the simulation value. See also "Simulation Mode".
Prerequisite	"Measuring mode" = Level and "Simulation mode" = Level
Value at switch-on	Current level measured value

Sim. tank cont. (116)



Navigation	Diagnosis → Simulation → Sim. tank cont. (116)
Write permission	Operators/Service engineers/Expert

Description	Enter the simulation value. See also "Simulation Mode".
Prerequisite	"Measuring Mode" = level, Lin mode "Activate table" and "Simulation Mode" = Tank content
Value at switch-on	Current tank content



Sim. Current (117)

Navigation	  Diagnosis → Simulation → Sim. Current (117)
Write permission	Operators/Service engineers/Expert
Description	Enter the simulation value. See also "Simulation Mode".
Prerequisite	"Simulation Mode" = Current value
Value at switch-on	Current current value



Sim. error no. (118)

Navigation	  Diagnosis → Simulation → Sim. error no. (118)
Write permission	Operators/Service engineers/Expert
Description	Enter the diagnostic message number. See also "Simulation Mode".
Prerequisite	"Simulation Mode" = Alarm/Warning
Value at switch-on	484 (Simulation active)



Enter reset code (124)

Navigation	  Diagnosis → Reset → Reset (124)
Write permission	Operators/Service engineers/Expert
Description	Reset parameters completely or partially to the factory values or order configuration by entering a reset code, see "Resetting to factory settings (reset)" section.(→  38)
Factory setting	0



Press. Eng. Unit (125)

Navigation	  Setup → Press. Eng. Unit (125)
Write permission	Operators/Service engineers/Expert
Description	Select the pressure engineering unit. If a new pressure engineering unit is selected, all pressure-specific parameters are converted and displayed with the new unit.
Options	<ul style="list-style-type: none"> ■ mbar, bar ■ mmH2O, mH2O, ■ in, H2O, ftH2O ■ Pa, kPa, MPa ■ psi ■ mmHg, inHg ■ kgf/cm²
Factory setting	mbar, bar or psi depending on the sensor module nominal measuring range, or as per order specifications



HART Input Form. (157)

Navigation	  Display/operat. → HART Input Form. (157)
Write permission	Operators/Service engineers/Expert
Description	Number of decimal places of the displayed input value.
Options	<ul style="list-style-type: none"> ■ x.x ■ x.xx ■ x.xxx ■ x.xxxx ■ x.xxxxx
Factory setting	x.x





Damping switch (164)

Navigation	  Setup → Damping switch (164)
Write permission	No write permissions. Parameter is read only.
Description	Displays the switch position of DIP switch 2 which is used to switch the damping of the output signal on and off.
Display	<ul style="list-style-type: none"> ■ Off The output signal is not damped. ■ On The output signal is damped. The attenuation constant is specified in the "Damping" (017) (184) parameter
Factory setting	On



Alarm cur.switch (165)

Navigation	  Setup → Advanced Setup → Current output → Alarm cur.switch (165)
Write permission	No write permissions. Parameter is read only.
Description	Displays the switching state of DIP switch 3 "SW/Alarm min."
Display	<ul style="list-style-type: none"> ■ SW setting The alarm current has the value defined in "Output Fail Mode" (051). ■ Alarm min. The alarm current is 3.6 mA, regardless of the software setting.



Corrected press. (172)

Navigation	  Setup → Corrected press. (172)   Diagnosis → Measured values → Corrected press. (172)
Write permission	No write permissions. Parameter is read only.6
Description	Displays the measured differential pressure after position adjustment.



Tank description (173)

Navigation	  Setup → Advanced Setup → Linearization → Tank description (173)
Write permission	Operators/Service engineers/Expert
Description	Enter the tank description (max. 32 alphanumeric characters)



High Press. Side (183)

Navigation	  Setup → High Press. Side (183)
Write permission	Operators/Service engineers/Expert
Description	Define which sensor module corresponds to the high-pressure side.
Options	<ul style="list-style-type: none"> ■ Sensor HP ■ Sensor LP
Factory setting	Sensor HP



Current at alarm (051)/(190)

Navigation	  Setup → Advanced Setup → Current output → Current at alarm (051)/(190)
Write permission	Operators/Service engineers/Expert
Description	Select Output fail mode. In case of an alarm, the current and the bargraph assume the current value specified with this parameter.
Options	<ul style="list-style-type: none"> ■ Max: can be set from 21 to 23 mA ■ Hold: last measured value is held. ■ Min: 3.6 mA
Factory setting	Max (22 mA)



Cust. tag number (254)

Navigation	  Diagnosis → Instrument info → Cust. tag number (254)
Write permission	Operators/Service engineers/Expert
Description	Enter the device tag, e.g. TAG number (max. 8 alphanumeric characters).
Factory setting	No entry or according to order specifications

COUNTER P < Pmin (262)

Navigation	  Diagnosis → Sensor HP → Counter P < Pmin (262)
Write permission	No write permissions. Parameter is read only.
Description	Displays the negative pressure counter for the respective sensor module. The counter is incremented each time error 841 occurs. You can reset this value using the "Reset Peakhold (161)" parameter.

COUNTER P > Pmax (263)

Navigation	  Diagnosis → Sensor HP → Counter P > Pmax (263)
Write permission	No write permissions. Parameter is read only.

Description Displays the overpressure counter for the respective sensor module. The limit value is: upper sensor module nominal value + 10% of upper sensor module nominal value. You can reset this value using the "Reset Peakhold (161)" parameter.

MIN. MEAS. TEMP. (264)

Navigation  Diagnosis → Sensor HP → Min. Meas. Temp. (264)

Write permission No write permissions. Parameter is read only.

Description Displays the smallest temperature measured in the sensor module. You can reset this value using the "Reset Peakhold (161)" parameter.

MAX. MEAS. TEMP. (265)

Navigation  Diagnosis → Sensor HP → Max. Meas.Temp. (265)

Write permission No write permissions. Parameter is read only.

Description Displays the largest temperature measured in the sensor module. You can reset this value using the "Reset Peakhold (161)" parameter.

Min. meas. press. (266)

Navigation  Diagnosis → Sensor LP → Minimum Pressure (266)

Write permission No write permissions. Parameter is read only.

Description Displays the lowest pressure value measured (peakhold indicator). You can reset this indicator by means of the "Reset peakhold" parameter.



COUNTER P < Pmin (267)

Navigation  Diagnosis → Sensor LP → Counter P < Pmin (267)



Write permission No write permissions. Parameter is read only.

Description Displays the negative pressure counter for the respective sensor module. The counter is incremented each time error 841 occurs. You can reset this value using the "Reset Peakhold (161)" parameter.



Max. meas. press. (268)

Navigation	  Diagnosis → Sensor LP → Maximum Pressure (268)
Write permission	No write permissions. Parameter is read only.
Description	Displays the highest pressure value measured (peakhold indicator). You can reset this peak indicator via the "Reset peakhold (161)" parameter.



COUNTER P > Pmax (269)

Navigation	  Diagnosis → Sensor LP → Counter P > Pmax (269)
Write permission	No write permissions. Parameter is read only.
Description	Displays the overpressure counter for the respective sensor module. The limit value is: upper sensor module nominal value + 10% of upper sensor module nominal value. You can reset this value using the "Reset Peakhold (161)" parameter.

MIN. MEAS. TEMP. (270)

Navigation	  Diagnosis → Sensor LP → Min. Meas.Temp. (270)
Write permission	No write permissions. Parameter is read only.
Description	Displays the smallest temperature measured in the sensor module. You can reset this value using the "Reset Peakhold (161)" parameter.

MAX. MEAS. TEMP. (271)

Navigation	  Diagnosis → Sensor LP → Max. Meas.Temp. (271)
Write permission	No write permissions. Parameter is read only.
Description	Displays the largest temperature measured in the sensor module. You can reset this value using the "Reset Peakhold (161)" parameter.

LRL sensor (272)

Navigation	  Diagnosis → Instrument info → Sens. Limit LP → LRL Sensor (272)
-------------------	---

Write permission No write permissions. Parameter is read only.

Description Displays the lower-range limit of the sensor module.

URL sensor (273)

Navigation  Diagnosis → Instrument info → Sens. Limit LP → URL Sensor (273)

Write permission No write permissions. Parameter is read only.

Description Displays the upper-range limit of the sensor module.

Device type code (279)

Navigation  Diagnosis → Instrument info → Device ID (279)

Write permission No write permissions. Parameter is read only.

Description Display of the numerical ID of the device
39

Sensor pressure LP (280)

Navigation  Diagnosis → Measured values → Sensor Press. LP (280)

Write permission No write permissions. Parameter is read only.

Description Displays the measured pressure before the sensor trim.



Meas. press. HP (281)

Navigation  Diagnosis → Measured values → Meas. Press. HP (281)



Write permission No write permissions. Parameter is read only.

Description Displays the measured HP pressure after sensor trim and simulation.



Meas. press. LP (282)

Navigation	  Diagnosis → Measured values → Meas. Press. LP (282)
Write permission	No write permissions. Parameter is read only.
Description	Displays the measured LP pressure after sensor trim and simulation.



Sensor Temp. LP (283)

Navigation	  Diagnosis → Measured values → Sensor Temp. LP (283)
Write permission	No write permissions. Parameter is read only.
Description	Displays the temperature currently measured in the sensor module. This can deviate from the process temperature.

Sim. Press. HP (284)

Navigation	  Diagnosis → Simulation → Sim. Press. HP (284)
Write permission	Operators/Service engineers/Expert
Description	Enter the simulation value. See also "Simulation Mode".
Prerequisite	"Simulation Mode" = Pressure HP
Value at switch-on	Current pressure measured value

Sim. Press. LP (285)

Navigation	  Diagnosis → Simulation → Sim. Press. LP (285)
Write permission	Operators/Service engineers/Expert
Description	Enter the simulation value. See also "Simulation Mode".
Prerequisite	"Simulation Mode" = Pressure LP
Value at switch-on	Current pressure measured value

3rd disp. value (288)

Navigation	  Display/operat. → 3rd Disp. Value (288)
-------------------	---

Write permission	Operators/Service engineers/Expert
Description	Specify the contents for the third value in the alternating display mode in measuring mode.
Options	<ul style="list-style-type: none">■ No value■ Differential pressure■ Pressure HP■ Pressure LP■ Sensor Temp. HP■ Sensor Temp. LP■ Level before linearization■ Current■ Main measured value (%) <p>The options depend on the measuring mode chosen.</p>
Factory setting	No value

18 Registered trademarks

18.1 HART®

Registered trademark of the HART Communication Foundation, Austin, USA

19 Technical data

More technical data can be found in the associated Technical Information.

Index

- 0 ... 9**
- 2nd disp. value (002) 78
 - 3rd disp. value (288) 106
- A**
- Adjust density (034) 88
 - Alarm Behav. P (050) 91
 - Alarm cur.switch (165) 101
 - ALARM STATUS (071) 92
 - Application 9
- C**
- Calibration mode (027) 85
 - CE mark (Declaration of conformity) 10
 - Cleaning 69
 - Code Definition (023) 84
 - Config. counter (100) 95
 - Configuration of a level measurement 48
 - Configuration of a pressure measurement 61
 - Configure high-pressure side 45
 - Configure language 45
 - Configure measuring mode 45
 - Configure pressure engineering unit 45
 - Configuring level measurement 48
 - Configuring pressure measurement 61
 - Corrected press. (172) 101
 - COUNTER P < Pmin (262) 102
 - COUNTER P < Pmin (267) 103
 - COUNTER P > Pmax (263) 102
 - COUNTER P > Pmax (269) 104
 - Current at alarm (051)/(190) 102
 - Cust. tag number (254) 102
- D**
- Damping (017)/(184) 82
 - Damping switch (164) 100
 - Decimal places 4 (parameter) 37
 - Declaration of conformity 10
 - Designated use 9
 - Device replacement 70
 - Device revision (108) 96
 - Device tag (022) 84
 - Device type code (279) 105
 - Diagnostic 1 (075) 93
 - Diagnostic 2 (076) 93
 - Diagnostic 3 (077) 93
 - Diagnostic 4 (078) 93
 - Diagnostic 5 (079) 93
 - Diagnostic 6 (080) 93
 - Diagnostic 7 (081) 93
 - Diagnostic 8 (082) 93
 - Diagnostic 9 (083) 93
 - Diagnostic 10 (084) 93
 - Diagnostic event 65
 - Diagnostic events 64
 - Diagnostic message 64
- Diagnostics**
- Symbols 64
- Display mode (001) 78
- Display module contrast 34
- Disposal 68
- E**
- Edit table (042) 90
 - Empty Calib. (011/28) 80
 - Empty Calib. (028)/(011) 86
 - Empty height (030)/(186) 87
 - Empty Pressure (029)/(185) 86
 - ENP version (099) 95
 - Enter reset code (124) 99
 - Error symbols 34
 - Event text 65
 - Ext. order code (097) 94
 - Exterior cleaning 69
- F**
- Field of application
 - Residual risks 9
 - Firmware version (095) 94
 - Format 1st Value (004) 79
 - Full Calib. (012/031) 80
 - Full Calib. (031)/(012) 87
 - Full height (033)/(188) 88
 - Full Pressure (032)/(187) 87
- G**
- Get LRV (015) 81
 - Get URV (016) 82
- H**
- HART Input Form. (157) 100
 - HART® protocol
 - Operating tools 40
 - Process variables 40
 - Version data for the device 40
 - Height unit (026) 85
 - High Alarm Curr. (052) 91
 - High Press. Side (183) 101
- L**
- Last diag. 1 (085) 94
 - Last diag. 2 (086) 94
 - Last diag. 3 (087) 94
 - Last diag. 4 (088) 94
 - Last diag. 5 (089) 94
 - Last diag. 6 (090) 94
 - Last diag. 7 (091) 94
 - Last diag. 8 (092) 94
 - Last diag. 9 (093) 94
 - Last diag. 10 (094) 94
 - Last diag. code (072) 92
 - Level before lin. (019) 82
 - Level Selection (024) 84

- Lin. mode (037) 89
 Line numb. (039) 89
 Local display
 see Diagnostic message
 see In alarm condition
 Local operation 33
 Locking status 35
 LRL sensor (101) 95
 LRL sensor (272) 104
- M**
 Maintenance 69
 Manufacturer ID (103) 96
 Max. meas. press. (074) 93
 Max. meas. press. (268) 104
 MAX. MEAS. TEMP. (265) 103
 MAX. MEAS. TEMP. (271) 104
 Meas. press. HP (281) 105
 Meas. press. LP (282) 105
 Meas.Diff.Press. (020) 83
 Measuring mode (005/182) 79
 Media 9
 Menu
 Overview 73
 Parameter description 78
 Min. meas. press. (073) 93
 Min. meas. press. (266) 103
 MIN. MEAS. TEMP. (264) 103
 MIN. MEAS. TEMP. (270) 104
- N**
 Nameplates 14
- O**
 Operating menu
 Overview 73
 Parameter description 78
 Operational safety 10
 Operator Code (021) 83
 Order code (098) 95
 Output current (054) 92
- P**
 Pos. Zero Adjust (007) 80
 Press. Eng. Unit (125) 99
 Process Density (035) 88
 Product safety 10
- R**
 Repair concept 70
 Replacing a device 70
- S**
 Safety instructions
 Basic 9
 Safety Instructions (XA) 7
 Sensor pressure HP (109) 96
 Sensor pressure LP (280) 105
 Sensor Temp. HP (110) 96
 Sensor Temp. LP (283) 106
- Serial number (096) 94
 Set LRV (013, 056, 166, 168) 81
 Set Min. Current (053) 92
 Set URV (014, 057, 167, 169) 81
 Sim. Current (117) 99
 Sim. diff.press. (113) 98
 Sim. error no. (118) 99
 Sim. level (115) 98
 Sim. Press. HP (284) 106
 Sim. Press. LP (285) 106
 Sim. tank cont. (116) 98
 Simulation mode (112) 97
 Spare parts 71
 Nameplate 71
 Staff
 Requirements 9
 Status signals 64
- T**
 Tank content (043) 91
 Tank description (173) 101
 Transmitter
 Turning the display module 21
 Troubleshooting 64
 Turning the display module 21
- U**
 Unit after lin. (038) 89
 Unit before lin. (025) 85
 URL sensor (102) 96
 URL sensor (273) 105
 Use of the measuring device
 see Designated use
 Use of the measuring devices
 Borderline cases 9
 Incorrect use 9
- W**
 W@M Device Viewer 71
 Workplace safety 10
- X**
 X-value (040)/(123)/(193) 90
- Y**
 Y-val (041)/(194) 90



www.addresses.endress.com
