



Level



Pressure



Flow



Temperature



Liquid
Analysis



Registration



Systems
Components



Services



Solutions

Operating Instructions

Solicap S FTI77

Capacitive point level switch

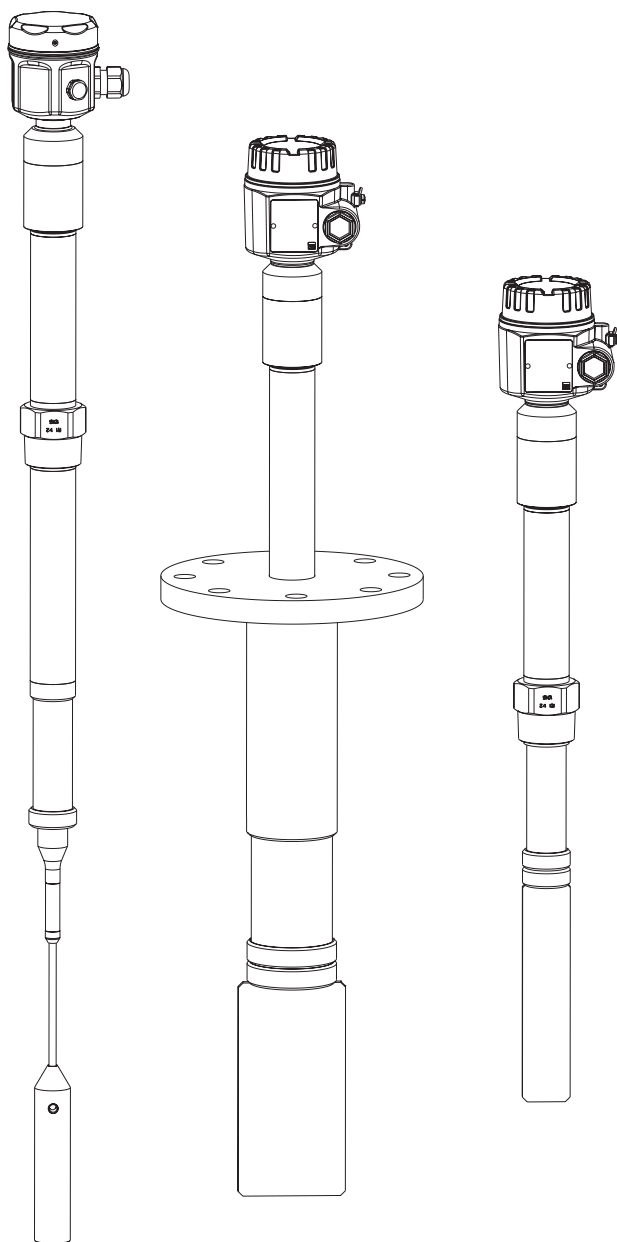





Brief overview



Note!

These Operating Instructions describe the installation and initial commissioning of the point level switch. It considers all of the functions that are necessary for a usual measuring task.

For quick and easy commissioning:

Safety instructions	
Explanation of the warning symbols For special instructions, refer to the corresponding location in the respective chapter. The priority is indicated by the Warning  , Caution  and Note  symbols.	→  8



Installation	
This section describes the required steps when installing the device and the installation conditions (such as dimensions).	→  13



Wiring	
The device is shipped, for the most part, completely wired and ready to plug in.	→  34



Display and operating elements	
This section provides an overview of the arrangement of the display and operating elements of the device.	→  46



Commissioning	
The "Commissioning" chapter shows you how to switch on the device and check its functions.	→  50



Troubleshooting	
If faults occur during operation, use the checklist to find the reason. This section lists measures you can take yourself to remedy any faults that may occur.	→  76

Brief operating instructions

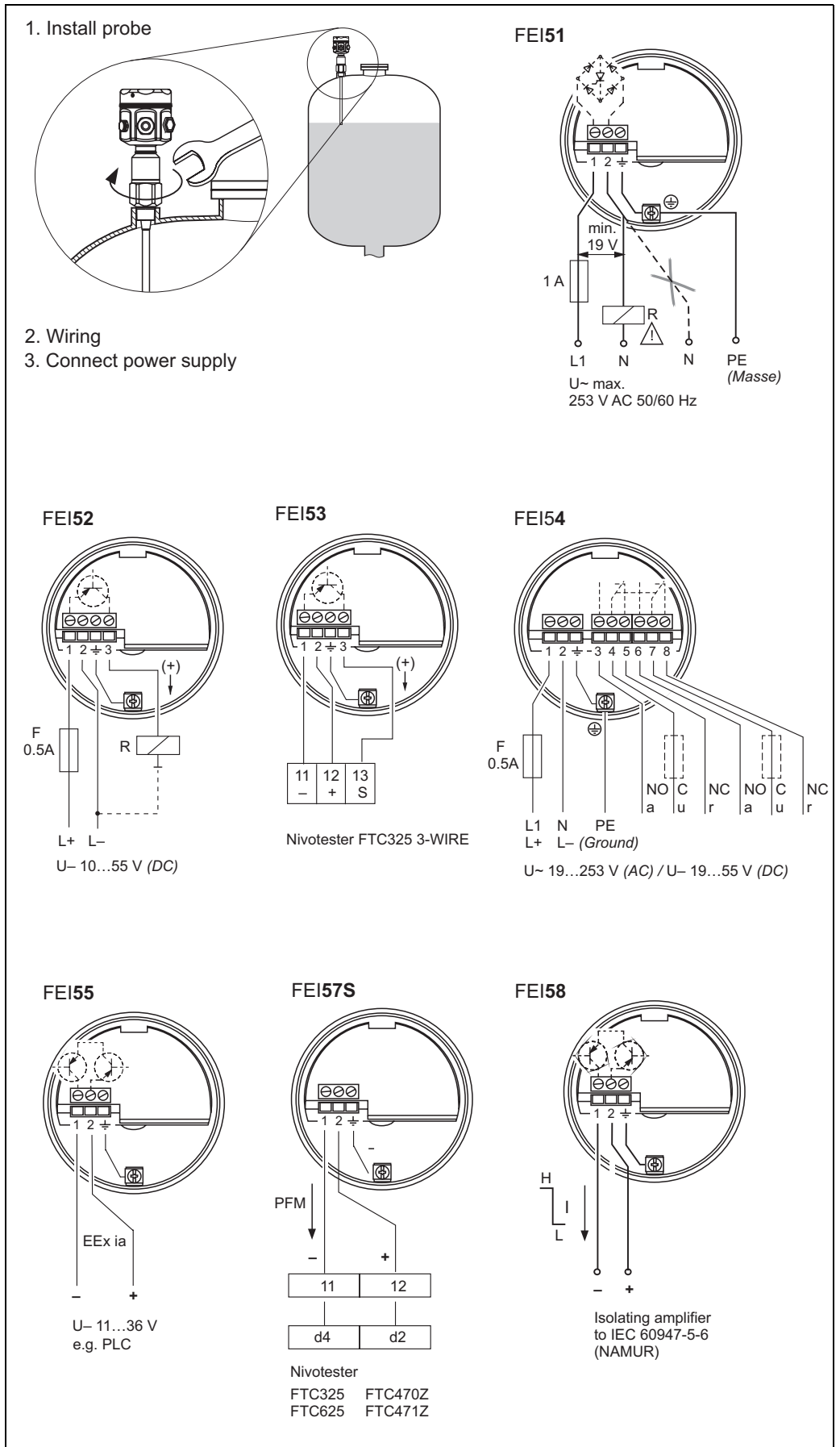

BA299Fes001

4. Switching on the power supply and configuring the device

Electronic inserts: FEI51, FEI52, FEI54, FEI55

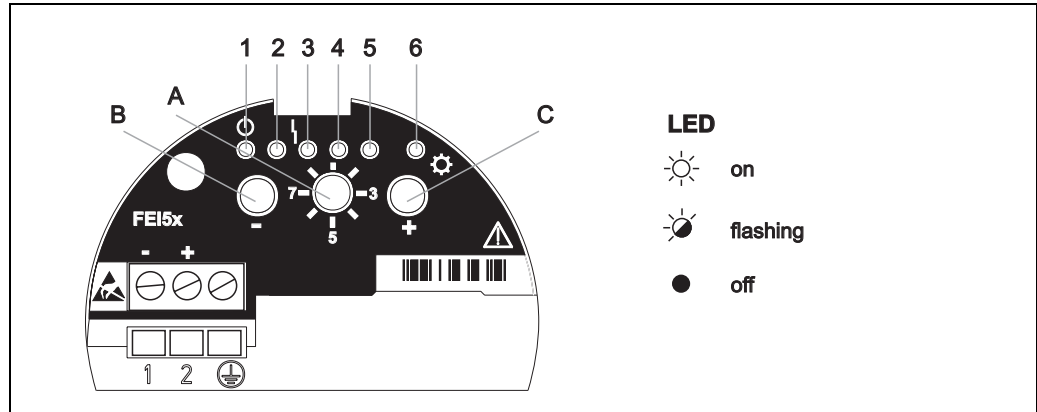

Green LED 1 (☰ operational), red LED 3 (⚡ fault), yellow LED 6 (⚙ switching state)

BA300Fen015

Function switch setting	Function	- key	+ key	Light emitting diodes (LED signals)					
				☰	☰	⚡	☰	☰	⚙
		●	●	☰ ● 1 (green)	☰ ● 2 (green)	⚡ ● 3 (red)	☰ ● 4 (green)	☰ ● 5 (green)	☰ ● 6 (yellow)
1	Operation			Flashes Operational LED	On (MIN-SIL)	Flashes (warning/ alarm)	On (MAX-SIL)		On/off/ flashes
	Restore factory setting	Press both keys for approx. 20 s		On	->	->	->	->	On/off/ flashes
2	Empty calibration	Press		On (present)					On/off/ flashes
	Full calibration		Press					On (present)	On/off/ flashes
	Reset: Calibration and switch point adjustment	Press both keys for approx. 10 s		On	->	->	->	->	On/off/ flashes
3	Switchpoint adjustment	Press for <	Press for >	On (2 pF)	Off (4 pF)	Off (8 pF)	Off (16 pF)	Off (32 pF)	On/off/ flashes
4	Measuring range	Press for <		On (500 pF)	Off (1600 pF)				On/off/ flashes
	Two-point control Δs		Press once					On	On/off/ flashes
	buildup mode		Press twice				On	On	On/off/ flashes
5	Switching delay	Press for <	Press for >	Off (0.3 s)	On (1.5 s)	Off (5 s)	Off (10 s)		On/off/ flashes
6	Self-test (function test)	Press both keys		Off (inactive)				Flashes (active)	On/off/ flashes
7	MIN-/MAX Fail-safe mode	Press for MIN	Press for MAX	Off (MIN)				On (MAX)	On/off/ flashes
	SIL mode* lock/unlock	Press both keys			On (MIN-SIL)		On (MAX-SIL)		On/off/ flashes
8	Upload/download Sensor DAT (EEPROM)	Press for download	Press for upload	Flashes (download)				Flashes (upload)	On/off/ flashes

* Only in conjunction with FEI55 electronic insert (SIL).

Electronic inserts: FEI53, FEI57S

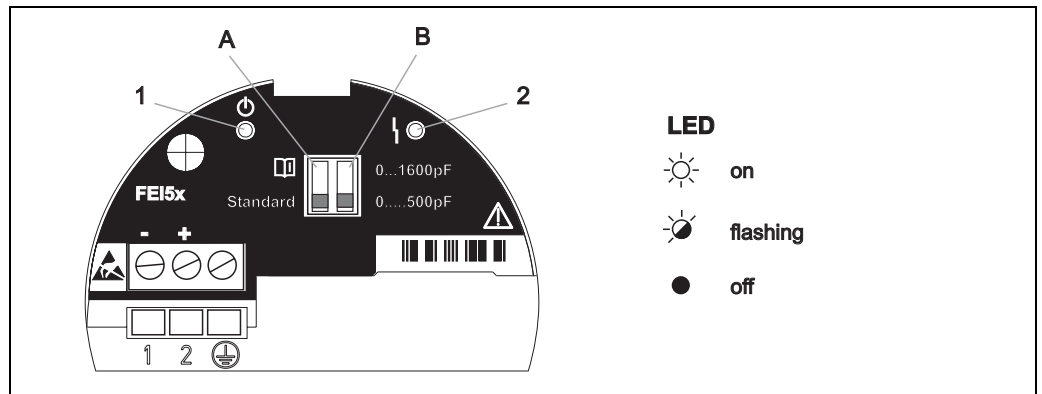

BA300Fen016

LED 1 operational ⏻: Flashes at 5-second intervals.

LED 2 fault ⚡: The red LED flashes if there is a fault that you can correct.

LED 2 fault ⚡: The red LED lights up continuously if the device has a fault that cannot be corrected. See also → 76, "Troubleshooting".

DIP switch	Function
A Standard	Standard ¹⁾ : If the measuring range is exceeded no alarm is output.
A	: If the measuring range is exceeded an alarm is output.
B 0.....500pF	Measuring range: The measuring range is between 0 to 500 pF. Span: The span is between 5 to 500 pF.
B 0...1600pF	Measuring range: The measuring range is between 0 to 1600 pF. Span: The span is between 5 to 1600 pF.

Electronic insert: FEI58

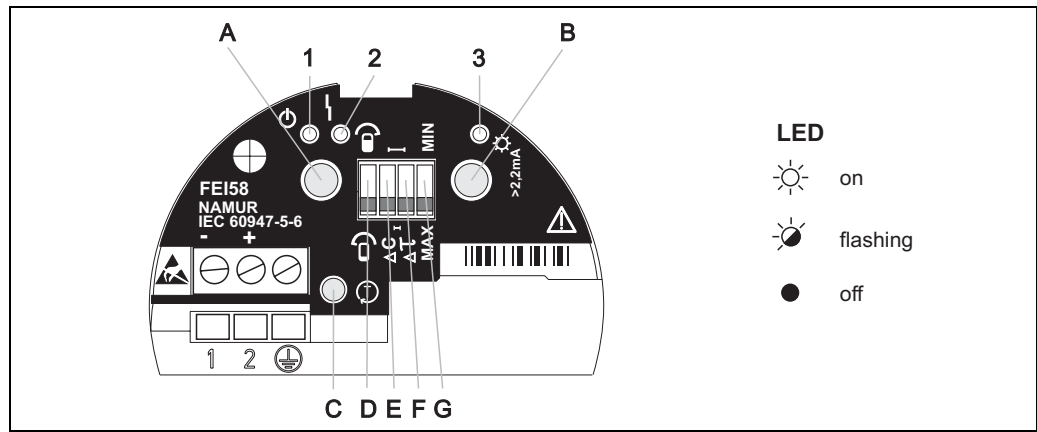

BA299Fen016

Green LED 1 (Ⓞ operational), red LED 2 (⚡ fault), yellow LED 3 (⚡ switching state)

DIP switches (C, D, E, F)		Function
D		The probe is covered during calibration.
D		The probe is uncovered during calibration.
E		Switchpoint adjustment: 10 pF
E		Switchpoint adjustment: 2 pF
F		Switching delay: 5 s
F		Switching delay: 1 s
G		Fail-safe mode: MIN The output switches safety-oriented when the probe is uncovered (signal on alarm). For use for dry running protection and pump protection for example
G		Fail-safe mode: MAX The output switches safety-oriented when the probe is covered (signal on alarm). For use with overflow protection for example

Key			Function
A	B	C	
X			Display diagnostic code
	X		Display calibration situation
X	X		Perform calibration (during operation)
X	X		Delete calibration points (during startup)
		X	Test key Ⓞ, (disconnects the transmitter from the switching unit)

Table of contents

1	Safety instructions	8	6	Commissioning	50
1.1	Designated use	8	6.1	Installation and function check	50
1.2	Installation, commissioning and operation	8	6.2	Commissioning the electronic inserts FEI51, FEI52, FEI54, FEI55	50
1.3	Operational safety	8	6.3	Commissioning with electronic inserts FEI53 or FEI57S 66	
1.4	Notes on safety conventions and icons	9	6.4	Commissioning with the electronic insert FEI58 ...	68
2	Identification	10	7	Maintenance	73
2.1	Device designation	10	8	Accessories	74
2.2	Scope of delivery	12	8.1	Weather protection cover	74
2.3	Certificates and approvals	12	8.2	Overvoltage protection HAW56x	74
3	Installation	13	8.3	Adapter flange FAU70E / FAU70A	75
3.1	Quick installation guide	13	9	Troubleshooting	76
3.2	Incoming acceptance, transport, storage	13	9.1	Fault diagnostics in the electronic insert	76
3.3	Overview	14	9.2	Spare parts	78
3.4	Housing	15	9.3	Return	79
3.5	Housing heights with adapter	16	9.4	Disposal	79
3.6	Process connections and flanges	16	9.5	Firmware history	79
3.7	Sword probes FTI77 for fine-grained bulk solids ..	17	9.6	Contact addresses at Endress+Hauser	79
3.8	Sword probes FTI77 for coarse-grained bulk solids	18	10	Technical data	80
3.9	Installation instructions	19	10.1	Input	80
3.10	Installation	27	10.2	Output	80
3.11	With separate housing	28	10.3	Performance characteristics	81
3.12	Probe without active buildup compensation	29	10.4	Operating conditions: Environment	81
3.13	Probe with active buildup compensation	31	10.5	Operating conditions: Process	83
3.14	Installing bracket for wall and pipe mounting	32	10.6	Other standards and guidelines	84
3.15	Post-installation check	33	10.7	Documentation	85
4	Wiring	34	Index		86
4.1	Connection recommendation	34			
4.2	Wiring in housing F16, F15, F17, F13	36			
4.3	Wiring in housing T13	37			
4.4	Connecting the device	38			
4.5	Degree of protection	38			
4.6	Electronic insert FEI51 (AC 2-wire)	39			
4.7	Connecting the electronic insert FEI52 (DC PNP) .	40			
4.8	Connecting the electronic insert FEI53 (3-WIRE) .	41			
4.9	Connecting the electronic insert FEI54 (AC/DC with relay output)	42			
4.10	Connecting the electronic insert FEI55 (8/16 mA, SIL2/SIL3)	43			
4.11	Connecting the electronic insert FEI57S (PFM) ...	44			
4.12	Connecting the electronic insert FEI58 (NAMUR) .	45			
4.13	Post-connection check	46			
5	Operation	46			
5.1	Human interface and display elements for FEI51, FEI52, FEI54, FEI55	46			
5.2	Human interface and display elements for FEI53, FEI57S	48			
5.3	Human interface and display elements for FEI58 ..	49			

1 Safety instructions

1.1 Designated use

Solicap S FTI77 is a rugged point level switch for the capacitive detection of bulk solids, and can be used in processes with temperatures up to 400 °C.

1.2 Installation, commissioning and operation

The Solicap S's state-of-the-art construction meets operating safety requirements and complies with all applicable standards and EU directives. However, if it is used improperly or if it is not put to its intended use, it can be a source of application-related dangers, such as product overflow due to incorrect installation or configuration. Therefore, the installation, electrical connection, commissioning, operation and maintenance of the measuring device only may be carried out by trained specialist personnel authorized by the facility's owner/operator for this purpose. The specialist personnel must have read and understood these Operating Instructions and must follow the instructions they contain. Modifications or repairs to the device can be carried out only if it is expressly stated in the Operating Instructions that these are permitted.

1.3 Operational safety













1.3.1 Hazardous areas

If the measuring system is used in hazardous areas, the corresponding national/federal standards and regulations must be observed. The device is accompanied by separate Ex documentation, which is an integral part of this documentation. Observe the installation instructions, connection data and safety instructions provided there.

- Ensure that the specialists are adequately trained.
- Observe the metrological and technical safety requirements for the measuring points.

1.4 Notes on safety conventions and icons

We have defined the following safety instructions to indicate safety-related or alternative procedures. Each instruction is identified by a corresponding pictogram.

Safety instructions	
	<p>Warning! This symbol indicates an action or procedure which, if not performed correctly, can result in serious injury, a safety hazard or the destruction of the device.</p>
	<p>Caution! This symbol indicates an action or procedure which, if not performed correctly, can result in injury or destruction of the device.</p>
	<p>Note! This symbol indicates an action or procedure which, if not performed correctly, can have an indirect effect on operation or trigger an unexpected response on the part of the device.</p>
Type of protection	
	<p>Explosion-protected, prototype-tested apparatus If this symbol appears on the nameplate of the device, the device can be used in hazardous or non-hazardous areas according to its approval.</p>
	<p>Hazardous areas In the drawings in these Operating Instructions, this symbol identifies hazardous areas. Devices located in hazardous areas and lines for these devices must have corresponding explosion protection.</p>
	<p>Safe areas (non-hazardous areas) In the drawings in these Operating Instructions, this symbol identifies non-hazardous areas. Devices in the non-hazardous area also must be certified if the connecting lines lead into the hazardous area.</p>
Electrical symbols	
	<p>Direct current A terminal at which DC voltage is present or through which DC voltage flows.</p>
	<p>Alternating current A terminal at which AC voltage (sinusoidal) voltage is present or through which AC flows.</p>
	<p>Ground connection A grounded terminal which, from the viewpoint of the user, is grounded via a grounding system.</p>
	<p>Protective ground connection A terminal that has to be grounded before other connections can be made.</p>
	<p>Equipotential connection A connection that has to be connected to the grounding system of the plant. This can be a potential equalization line or a radial grounding system depending on national and company codes of practice.</p>
	<p>Temperature resistance of the connecting cables Indicates that the connecting cables must be able to withstand temperatures of at least 85 °C.</p>

2 Identification

2.1 Device designation

2.1.1 Nameplate

Refer to the nameplate of the device for the following technical data:

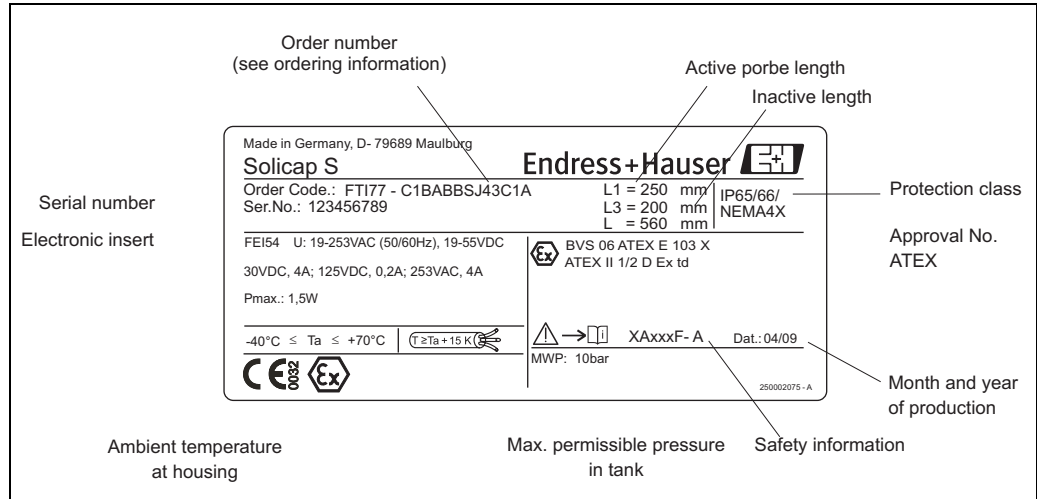

Information on the Solicap S nameplate (example)

2.1.2 Device identification

Solicap S FTI77



Note!

You can understand what the order code means with the aid of the information in the following table (see nameplate).

Example: order code => FTI77 - A1BABBSJ43C1A

- A = Approval: non-hazardous area,
- 1 = Application: fine-grained bulk solids
- B = Inactive length L3: 200 mm steel,

...

10	Approval:	
	A	Non-hazardous area
	B	ATEX II 1/3 D Ex tD
	C	ATEX II 1/2 D Ex tD
	D	ATEX II 3 D Ex nA/nL/nC
	F	ATEX II 1 D, 1/2 D, 1/3 D EEx ia D20 T 90 °C
	K	CSA General Purpose, CSA C US
	L	CSA/FM IS Cl. I, II, III, Div. 1+2, Gr. A-G
	M	CSA/FM XP Cl. I, II, III, Div. 1+2, Gr. A-G
	N	CSA/FM DIP Cl. II, III, Div. 1+2, Gr. E-G
	Y	Special version, to be specified
15	Application:	
	1	Solid, fine-grained
	2	Solid, coarse-solids
	9	Special version
20	Inactive length L3:	
	A	Not selected
	B	200 mm steel
	C	400 mm steel

20		Inactive length L3:		
E	200 mm			316L
F	400 mm			316L
G	... mm			316L
H	... mm, inactive length + 125 mm active buildup compensation			316L
L	8 inch			steel
M	16 inch			steel
N	8 inch			316L
P	16 inch			316L
R	... inch			316L
S	... inch, inactive length + 5 inch active buildup compensation			316L
9	Special version			
30		Active length L1:		
AB	200 mm	sword	steel	
AC	400 mm	sword	steel	
AD	700 mm	sword	steel	
BB	200 mm	sword	316L	
BC	400 mm	sword	316L	
BR	... mm	sword	316L	
CR	... mm	6 mm rope	steel zinc coated	tension weight steel
CS	... mm	12 mm rope	steel zinc coated	tension weight steel
DR	... mm	6 mm rope	316L	tension weight 316L
DS	... mm	12 mm rope	316L	tension weight 316L
EB	8 inch	sword	steel	
EC	16 inch	sword	steel	
ED	28 inch	sword	steel	
FB	8 inch	sword	316L	
FC	16 inch	sword	316L	
FR	... inch	sword	316L	
GR	... inch	0.24 " rope	steel zinc coated	tension weight steel
GS	... inch	0.47 " rope	steel zinc coated	tension weight steel
HR	... inch	0.24 " rope	316L	tension weight 316L
HS	... inch	0.47 " rope	316L	tension weight 316L
VV	Connection thread, prepared for active probe length			
YY	Special version, to be specified			
50		Process connection:		
AFJ	2",	150 lbs RF	316/316L	
AGJ	3",	150 lbs RF	316/316L	
AHJ	4",	150 lbs RF	316/316L	
AH1	4",	150 lbs RF	steel	
BSJ	DN80,	PN10/16 A	316L	EN1092-1 (DIN2527 B)
BTJ	DN100,	PN10/16 A	316L	EN1092-1 (DIN2527 B)
BT1	DN100,	PN10/16 A	steel	EN1092-1 (DIN2527 B)
B3J	DN50,	PN25/40 A	316L	EN1092-1 (DIN2527 B)
KFJ	10K 50,	RF	316L	JIS B2220
KGJ	10K 80,	RF	316L	JIS B2220
KHJ	10K 100,	RF	316L	JIS B2220
KH1	10K 100,	RF	steel	JIS B2220
RGJ	NPT 1½,		316L	thread ANSI
RG1	NPT 1½,		steel	thread ANSI
RVJ	R 1½,		316L	thread EN10226
RV1	R 1½,		steel	thread EN10226
YY9	Special version, to be specified			
60		Electronics; Output:		
1	FEI51; 2-wire			19 to 253 VAC
2	FEI52; 3-wire PNP,			10 to 55VDC
3	FEI53; 3-wire,			3 to 12 V signal
4	FEI54; relay DPDT,			19 to 253 VAC, 19 to 55 VDC
5	FEI55; 8/16 mA,			11 to 36VDC
7	FEI57S; 2-wire PFM			
8	FEI58; NAMUR+test key (H-L signal)			
W	Prepared for FEI5x			
Y	Special version, to be specified			

70										Housing:		
										1	F15 316L	IP66, NEMA4X
										2	F16 polyester	IP66, NEMA4X
										3	F17 Alu	IP66, NEMA4X
										4	F13 Alu + gas-tight probe seal	IP66, NEMA4X
										5	T13 Alu + gas-tight probe seal + separate connection compartment	IP66, NEMA4X
										9	Special version, to be specified	
80										Cable entry:		
										A	Gland M20	
										B	Thread G ½	
										C	Thread NPT ½	
										D	Thread NPT ¾	
										G	Thread M20	
										E	M12 connector	
										F	7/8" connector	
										Y	Special version, to be specified	
90										Type of probe:		
										1	Compact	
										2	2000 mm L4 cable	> separate housing
										3 mm L4 cable	> separate housing
										4	80 inch L4 cable	> separate housing
										5 inch L4 cable	> separate housing
										9	Special version, to be specified	
100										Additional option:		
										A	Basic version	
										D	EN10204-3.1 material (316L pressurized),	Inspection certificate
										F	SIL Declaration of Conformity	
										Y	Special version, to be specified	
FTI77										Product designation		

2.2 Scope of delivery

The scope of delivery consists of:

- The mounted device
- Where applicable, accessories (see →  74)

Provided documentation:

- Operating Instructions
- Approval documentation, if not included in the Operating Instructions.

2.3 Certificates and approvals

CE mark, Declaration of Conformity

The device is designed to meet state-of-the-art operating safety requirements, has been tested, and has left the factory in a condition in which it is safe to operate. The device meets the relevant standards and directives listed in the EC Declaration of Conformity and thus fulfills the legal requirements of the EC Directives. Endress+Hauser confirms that the device has been successfully tested by applying the CE mark.

3 Installation



Note!
All dimensions in mm.

3.1 Quick installation guide

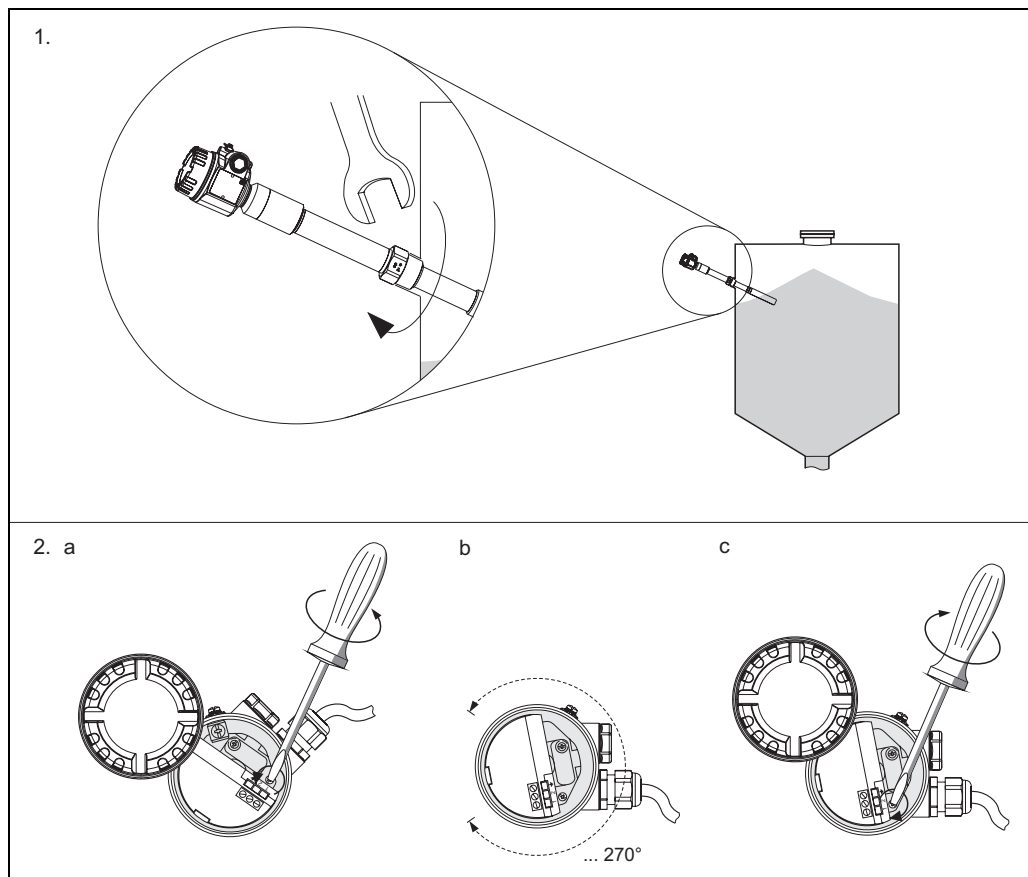

- 1.) Screw in the device
 2. a) Release the securing screw in the housing until the housing rotates easily.
 2. b) Align the housing as required.
 2. c) Tighten the securing screw (< 1 Nm) until the housing can no longer be turned.

3.2 Incoming acceptance, transport, storage

3.2.1 Incoming acceptance

Check the packaging and the contents for damage.
 Check the shipment, make sure nothing is missing and that the scope of supply matches your order.

3.2.2 Storage

Pack the device so that is protected against impact for storage and transport. The original packaging provides optimum protection here.
 The permitted storage temperature is -50°C to $+85^{\circ}\text{C}$.

3.3 Overview

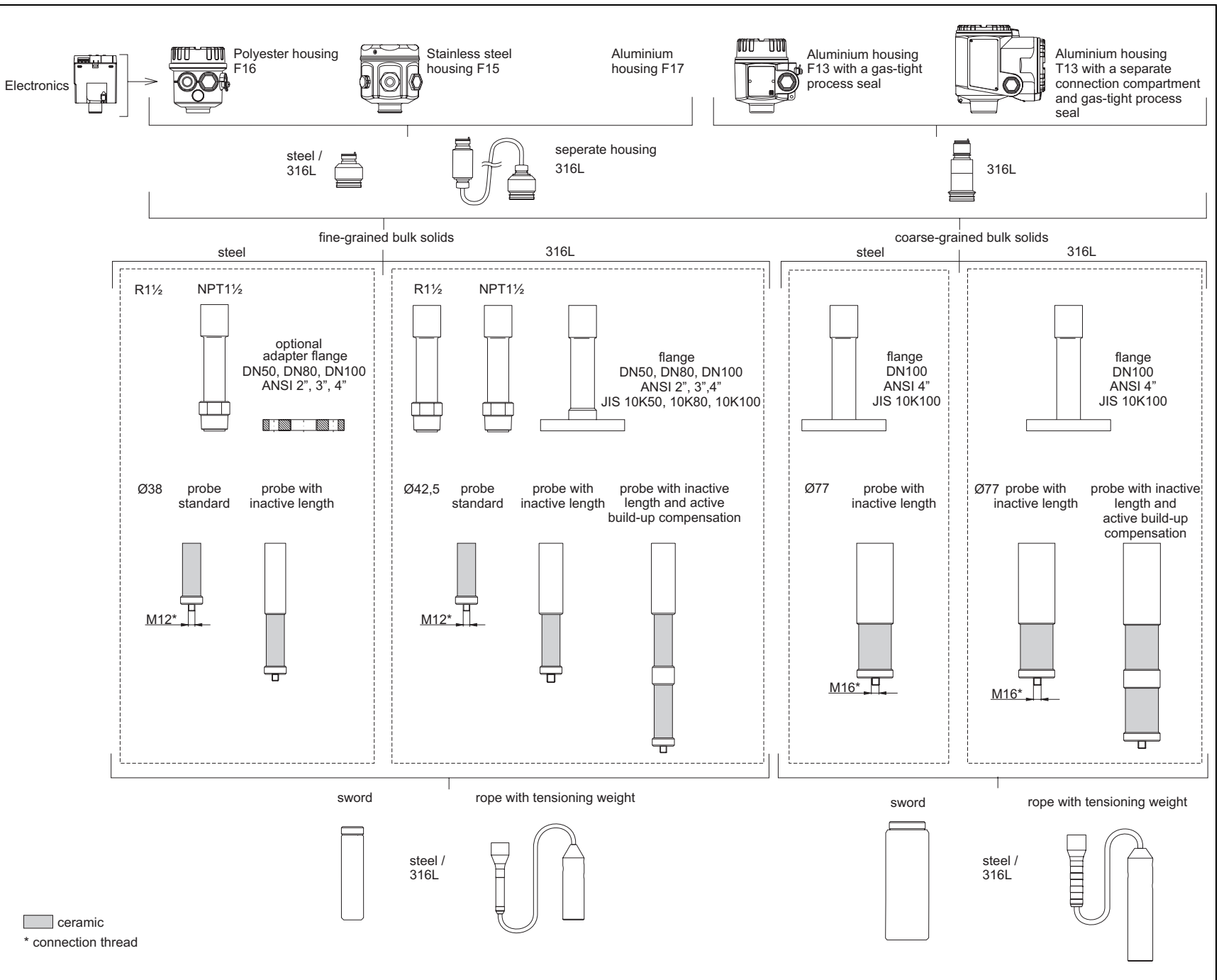

BA30178/02

3.4 Housing

Polyester housing F16

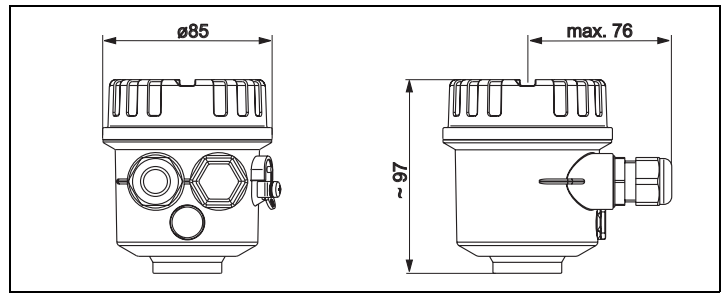

T1418F25

Stainless steel housing F15

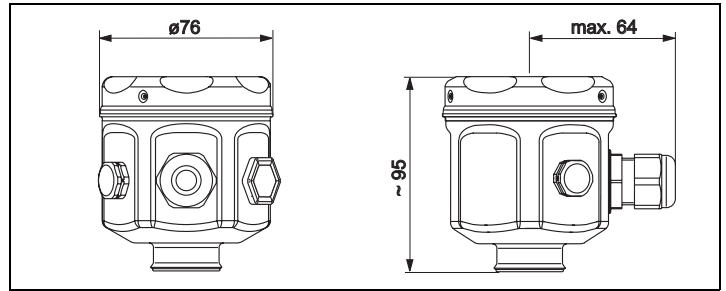

T1418F26

Aluminum housing F17

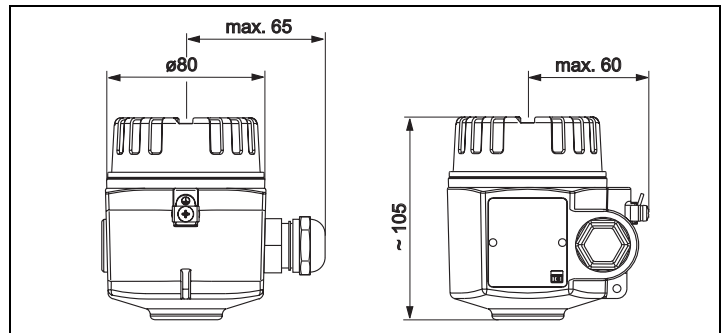

T1418F27

Aluminum housing F13 with gas-tight process seal

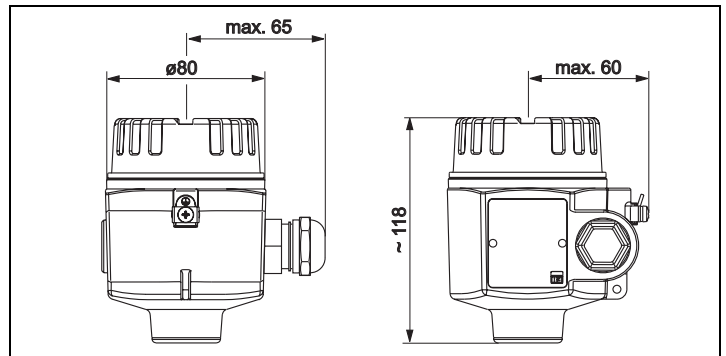

T1418F28

Aluminum housing T13 with separate connection compartment and gas-tight process seal

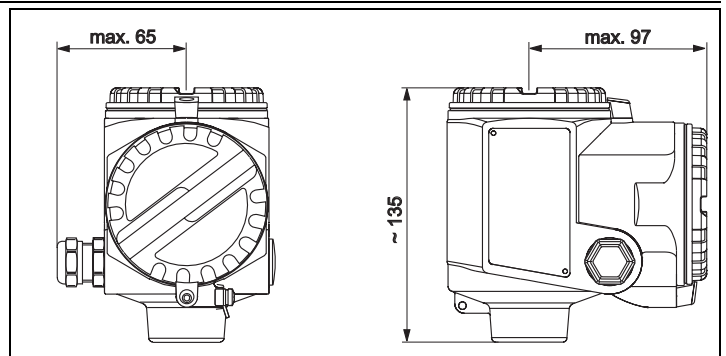

T1418F29

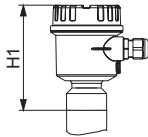
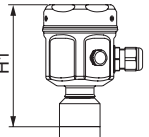
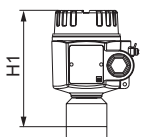
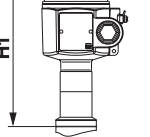
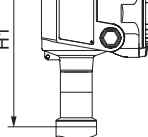

3.5 Housing heights with adapter

	Polyester housing F16	Stainless steel housing F15	Aluminum housing F17	Aluminum housing F13*	Aluminum housing with separate connection compartment T13*
					
	BA381Fxx003	BA381Fxx004	BA381Fxx005	BA381Fxx006	BA381Fxx007
Order code	2	1	3	4	5
FTI77					
H1	125**/177	121**/ 173	131**/183	177	194

* Housing with gas-tight process seal

** For Approval: A (Non-hazardous area) or K (CSA General Purpose, CSA C US). => Device identification.

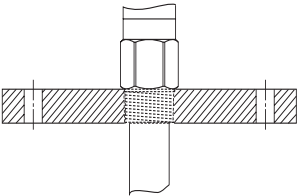
3.6 Process connections and flanges

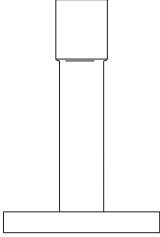
	Thread: R 1½*	Thread: NPT 1½*	Flanges
			
BA381Fxx025 <i>* Optional with adapter flange (for steel)</i>	BA381Fxx008 (DIN EN 10226-1)	BA381Fxx009 (ANSI B 1.20.1)	BA381Fxx010 (EN1092-1) (ANSI B 16.5) (JIS B2220)
Order code/material	RVJ / 316L RV1 / steel*	RGJ / 316L RG1 / steel*	
Pressures up to	10 bars	10 bars	Depends on flange max. 10 bar

3.7 Sword probes FTI77 for fine-grained bulk solids



Note!

Total length of the probe from the start of the thread: $L = L1 + L3 + 110 \text{ mm (ceramic)} + 125 \text{ mm}$ with active buildup compensation (optional)

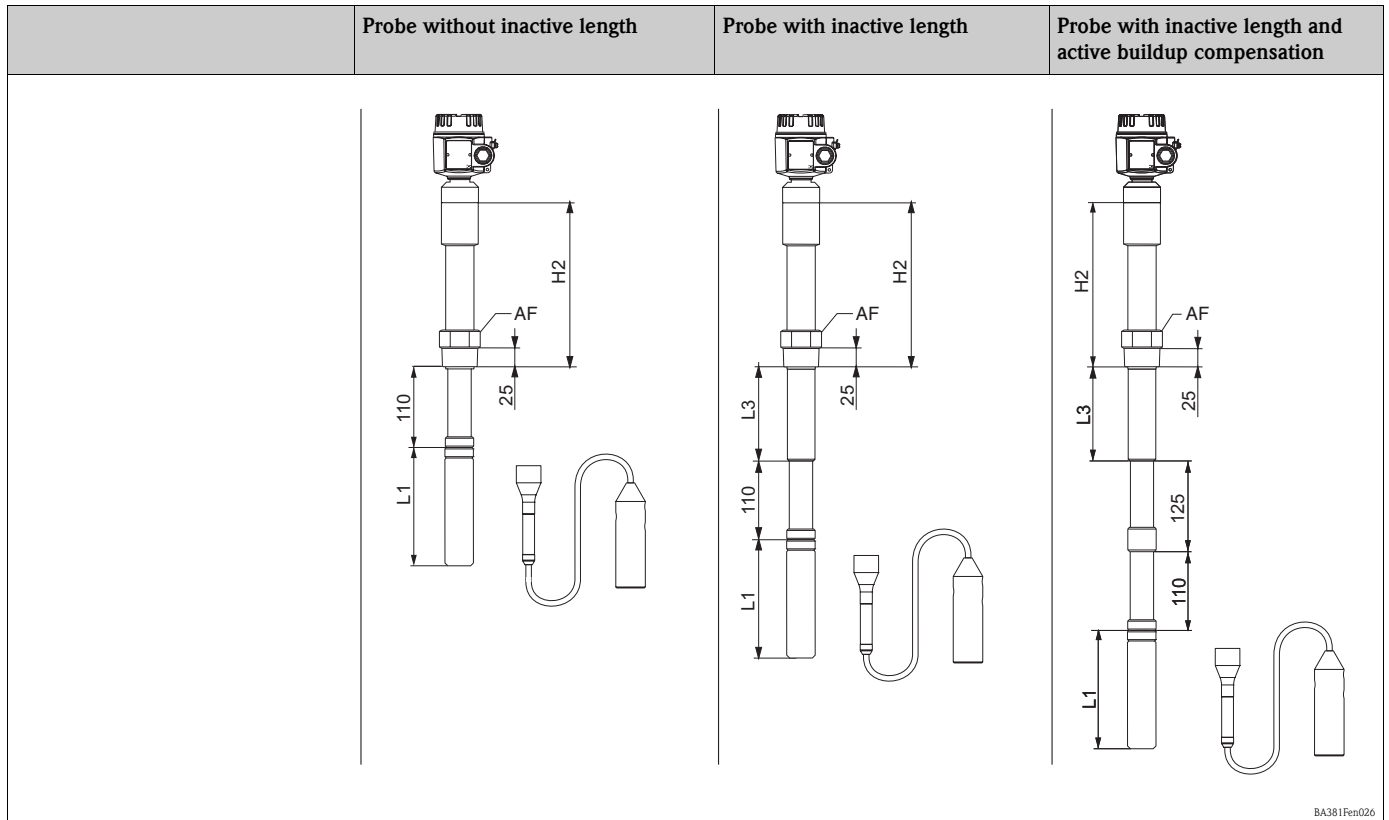

BA381Fen026

	Probe without inactive length		Probe with inactive length		Probe with inactive length and active buildup compensation	
Sword/rope	Sword	Rope	Sword	Rope	Sword	Rope
H2	259	259	259	259	259	259
Across flats (AF)	55	55	55	55	55	55
Total length (L)	310 ... 1110	610 ... 20000	410 ... 2110	710 ... 20000	535 ... 2235	835 ... 20000
Active length L1	200 ... 1000	500 ... 19890	200 ... 1000	500 ... 19790	200 ... 1000	500 ... 19665
Inactive length (L3)	–	–	100 ... 1000	100 ... 1000	100 ... 1000	100 ... 1000
ø inactive length [L3 (steel/316L)]	–	–	38/42,5	38/42,5	38/42,5	38/42,5
Sword width	40	–	40	–	40	–
ø rope	–	6	–	6	–	6
ø active buildup compensation	–	–	–	–	40	40
ø tensioning weight	–	30	–	30	–	30
Lateral loading capacity (Nm) at 20 °C	250	–	250	–	250	–
For use in mounting nozzles	–	–	X	X	X	X
In the event of condensate on tank ceiling	–	–	X	X	X	X
Tensile loading capacity kN	–	7,5	–	7,5	–	7,5
Length of tensioning weight	–	150	–	150	–	150

X = recommended

Length tolerance of sword probe < 1 m: 0 to –5 mm; > 1 m to 3 m: 0 to –10 mm

Length tolerance of rope probe < 1 m: 0 to –10 mm; > 1 m to 3 m: 0 to –20 mm; > 3 m to 6 m: 0 to –30 mm, > 6 m to 20 m: 0 to –40 mm

3.8 Sword probes FTI77 for coarse-grained bulk solids

Total length of the probe from the start of the thread: $L = L1 + L3$

- + 110 mm (ceramic for probe with inactive length) **or**
+ 92 mm (ceramic for probe with inactive length and active buildup compensation)
- + 125 mm with active buildup compensation (optional)

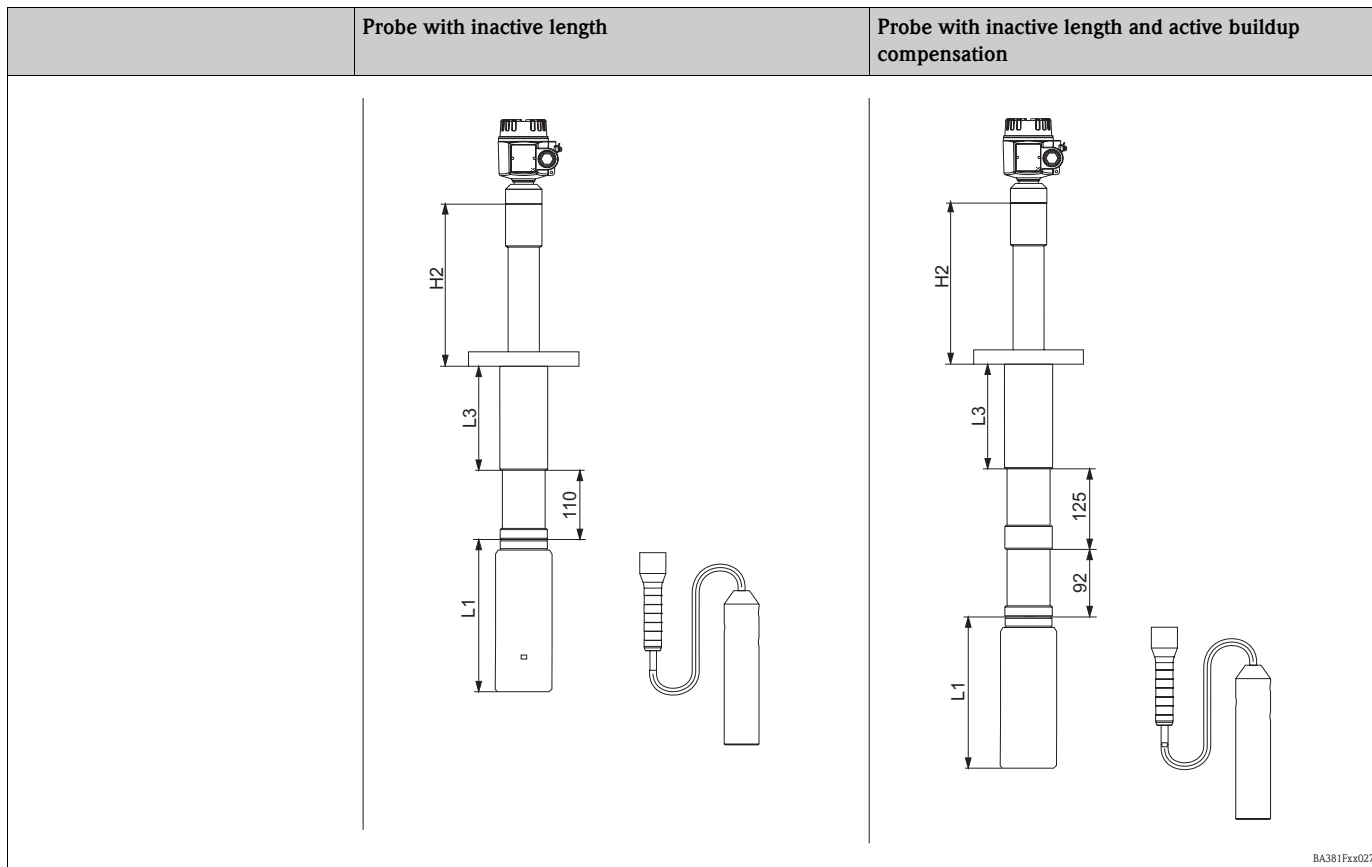

BA381Fxx027

	Sword	Rope	Sword	Rope
Sword/rope	Sword	Rope	Sword	Rope
H2	259	259	259	259
Total length (L)	410 ... 2110	710 ... 20000	517 ... 2235	817 ... 20000
Active length (L1)	200 ... 1000	500 ... 19790	200 ... 1000	500 ... 19665
Inactive length (L3)	100 ... 1000	100 ... 1000	100 ... 1000	100 ... 1000
ø inactive length	77	77	77	77
Sword width	90	-	90	-
ø rope	-	12	-	12
ø active buildup compensation	-	-	76	76
ø tensioning weight	-	40	-	40
Lateral loading capacity (Nm) at 20 °C	800	-	800	-
For use in mounting nozzles	X	X	X	X
In the event of condensate on tank ceiling	X	X	X	X
Tensile loading capacity kN	-	20	-	20
Length of tensioning weight	-	250	-	250

X = recommended

Length tolerance of sword probe < 1 m: 0 to -5 mm; > 1 m to 3 m: 0 to -10 mm

Length tolerance of rope probe < 1 m: 0 to -10 mm; > 1 m to 3 m: 0 to -20 mm; > 3 m to 6 m: 0 to -30 mm, > 6 m to 20 m: 0 to -40 mm

3.9 Installation instructions

3.9.1 Installation instructions

The Solicap S FTI77 (sword probe) can be installed horizontally or vertically.
The Solicap S FTI77 (rope probe) can be installed vertically from above.



Caution!

If you order a probe that is prepared for subsequent mounting of an active length (feature: active length; version: VV), grounding must take place at the lower ceramic fixture when welding on the active length.



Note!

The probe may not come into contact with the container wall! Do not install probes in the area of the filling curtain!

3.9.2 General notes

Filling the silo

The filling stream should not be directed onto the probe.

Angle of material flow

Note the expected angle of the material flow or of the outlet funnel when determining the mounting location or probe length.

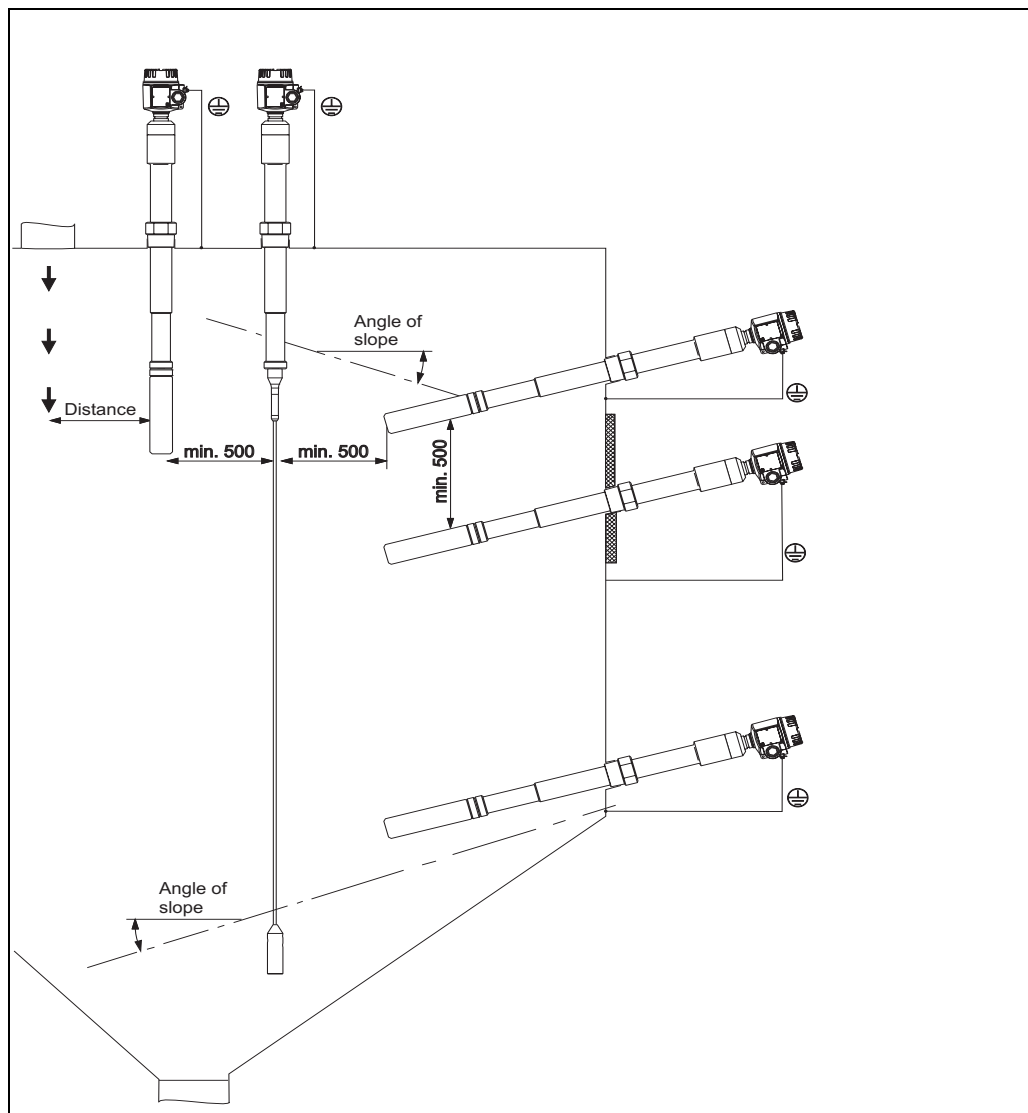

BA381Fen003

Distance between probes

When installing several probes in a silo, a minimum distance of 0.5 m between the probes must be observed.

Threaded coupling for mounting

When installing the Solicap S FTI77, the threaded coupling should be as short as possible. Condensation or product residue may occur in a long threaded coupling and interfere with the correct operation of the probe.

Heat insulation

In the event of high temperatures in the silo:

Insulate the external silo wall to avoid exceeding the permitted temperature of the Solicap S housing. Heat insulation also prevents condensation from forming near the threaded boss in the silo. This reduces buildup and the risk of error switching.

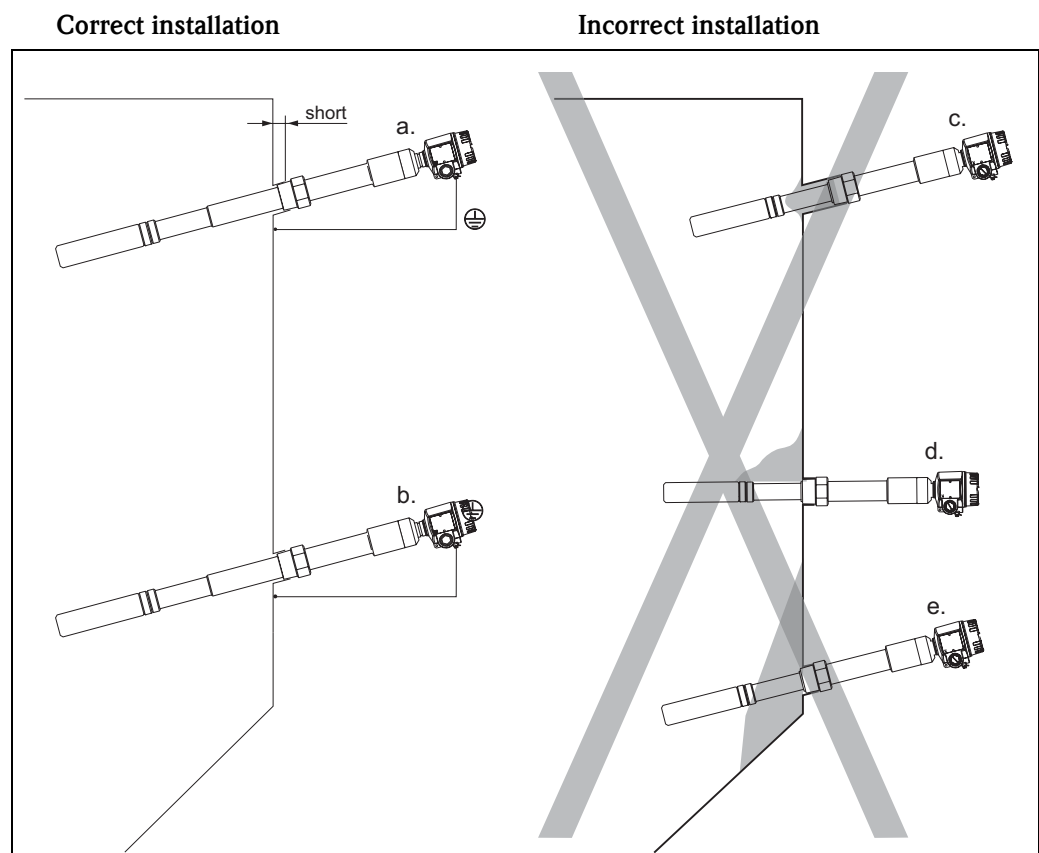
3.9.3 Preparing to install sword probes FTI77

BA381Fen004

Correct installation

- a. For maximum level limit detection, a short threaded coupling is used.
- b. For maximum level limit detection, a short threaded coupling is used.

**Note!****Aligning the sword probe**

To prevent unnecessary lateral load when installing the sword probe from the side, the sword must be installed with the narrow edge pointing upwards. An adhesive label indicates the installation position of the sword.

Incorrect installation

- c. The threaded coupling is too long. This may cause material to settle inside and result in error switching.
- d. Horizontal mounting means a risk of error switching in the event of heavy buildup on the silo wall.
In this case, the Solicap S FTI77 (sword probe) with inactive length is recommended.
- e. In areas where product buildup occurs, the device cannot detect if the silo is "empty".
In this case, the FTI77 (rope probe) should be installed from above.

In this example, the grounded steel plate forms the counter electrode.

Heat insulation prevents condensation and therefore buildup on the steel plate.

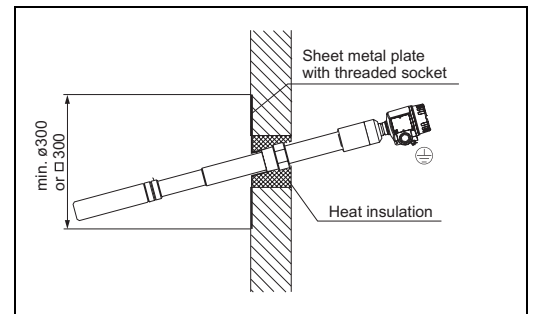

BA 381 Fer005

In a silo with concrete walls

When installing in a nonconductive container, a sheet metal plate must be attached to the exterior of the silo as a counter electrode. This plate can be either square or round.

- Dimensions in the case of a thin silo wall with a low dielectric constant:
approx. 0.5 m along each side or $\varnothing 0.5$ m;
- Dimensions in the case of a thicker silo wall or wall with a higher dielectric constant:
approx. 0.7 m along each side or $\varnothing 0.7$ m.

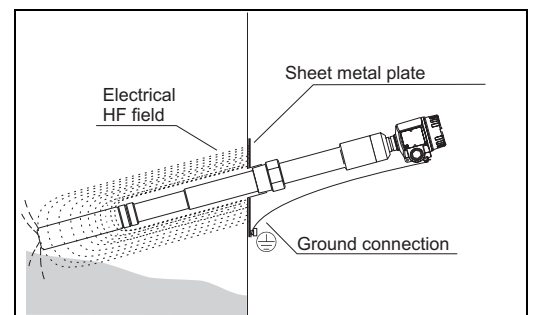

BA 381 Fer006

In a silo with plastic walls

Probe length and minimum coverage



Note!

- When selecting the probe length, pay attention to the dependency between the relative dielectric constant ϵ_r and the minimum amount the probe needs to be covered (see Table).
- For probe length tolerances see → 17
- To ensure problem-free operation, it is important that the difference in capacitance between the covered and uncovered parts of the probe is at least 5 pF.
- If you do not know the dielectric constant of the material, contact us for advice.

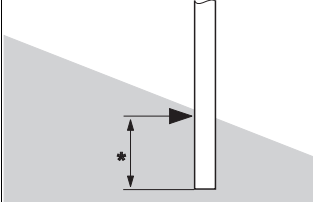
Product properties, relative dielectric constant ϵ_r	 <p style="text-align: right; font-size: small;">TI418F12</p> <p><i>* Minimum coverage</i></p>
Electrically conductive	25 mm
Nonconductive	
$\epsilon_r > 10$	100 mm
$\epsilon_r > 5$ to 10	200 mm
$\epsilon_r > 2$ to 5	500 mm

3.9.4 Preparing to install rope probes FTI77

Correct installation

Incorrect installation

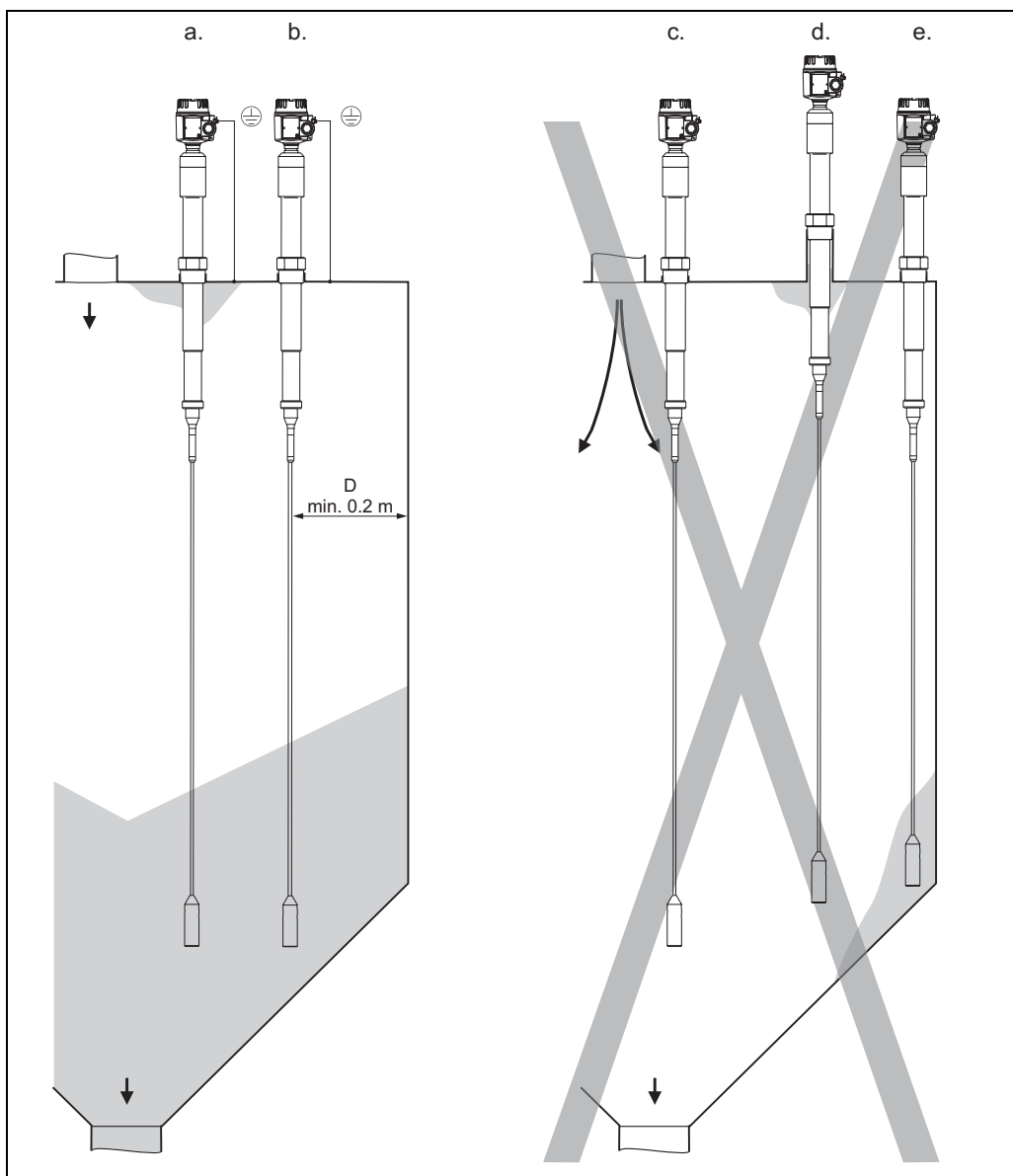

In a silo with metal walls Distance D between the probe and the wall approx. 10 to 25 % of the silo diameter

Correct installation

- Solicap S FTI77 with inactive length in the event of condensation and material buildup on the silo roof.
- At the correct distance from the silo wall, the material inlet and the material outlet. Close to the wall, for reliable switching in the case of a low dielectric constant (not for pneumatic filling). For pneumatic filling, the distance from the probe to the wall should not be too short, as the probe may swing.

Incorrect installation

- If too close to the material inlet, inflowing bulk solids may damage the sensor. If close to the center of the material outflow, high tensile forces at this point may cause the probe to break off or subject the silo roof to excessive strain.
- The threaded coupling is too long. This may cause condensation and dust to settle inside which may result in error switching.

- e. If too close to the silo wall, the probe may swing slightly against the wall or come in contact with buildup. This can result in error switching.

Silo roof

Ensure that the silo roof is of a sufficiently stable construction.

High tensile forces may occur when material is being extracted, particularly in the case of heavy and powdery bulk solids which have a tendency to form buildup.

Abrasive bulk solids

In silos with extremely abrasive bulk solids, the use of a Solicap S FTI77 is recommended only for maximum detection.

Distance between the rope probes

To rule out mutual probe interference, you must maintain a minimum distance of 0.5 m between the rope probes. This also applies if you are installing several Solicap S units in adjacent silos with nonconductive walls.

In the event of condensation:

Use the FTI77 with inactive length.

The inactive length (**Fig. A**) prevents moisture and buildup forming between the active part of the probe and the silo roof.

Or:

To reduce the effects of condensation (**Fig. B**) and buildup, the threaded coupling (length: max. 25 mm) must project into the silo.

Heat insulation reduces condensation and therefore buildup on the steel plate.

Fig. A

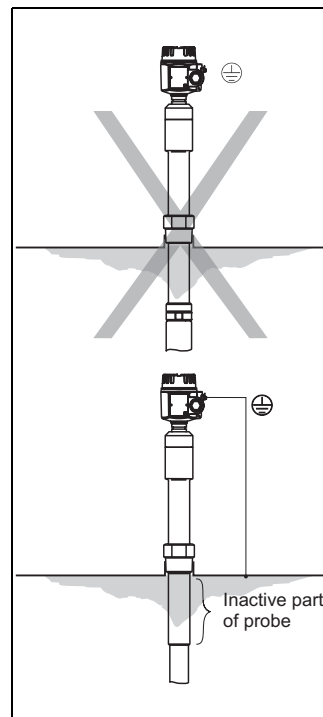
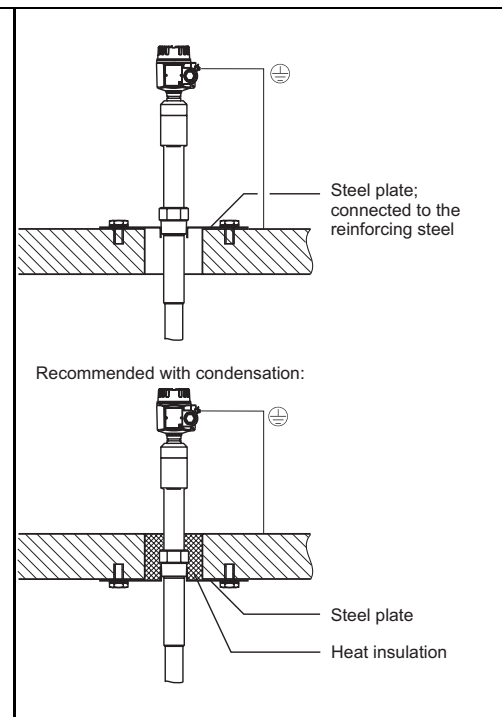

Fig. B



Silo with walls that conduct electricity

Silo with concrete walls

In the event of buildup:

If buildup on the sword probe can be expected when operating the measuring system, the active buildup compensation function prevents the measurement result from becoming distorted. This renders cleaning work on the sword probe unnecessary.

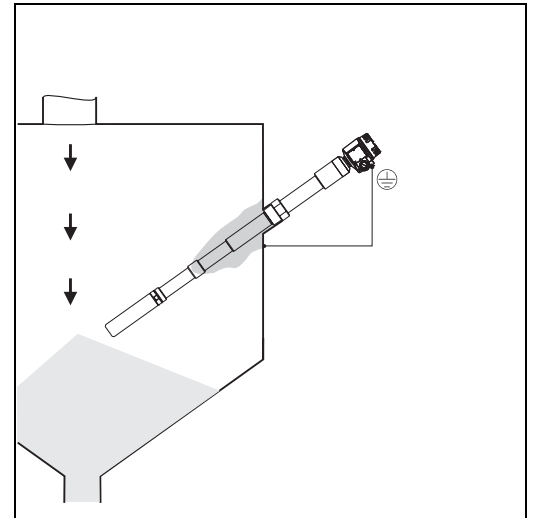

BA381Fxx014

Installation in a nonconductive tank

When installing in a silo made of concrete, a counter electrode must be mounted on the silo exterior at the same height as the tensioning weight.

The length of the edge of the counter electrode should be approximately the same length as the distance between the tensioning weight and the silo wall.

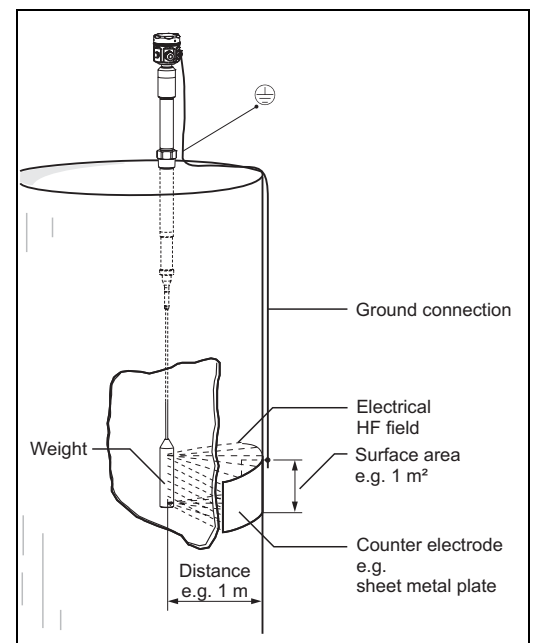

BA381Fen010

In a silo with plastic walls

Range of sensor lengths

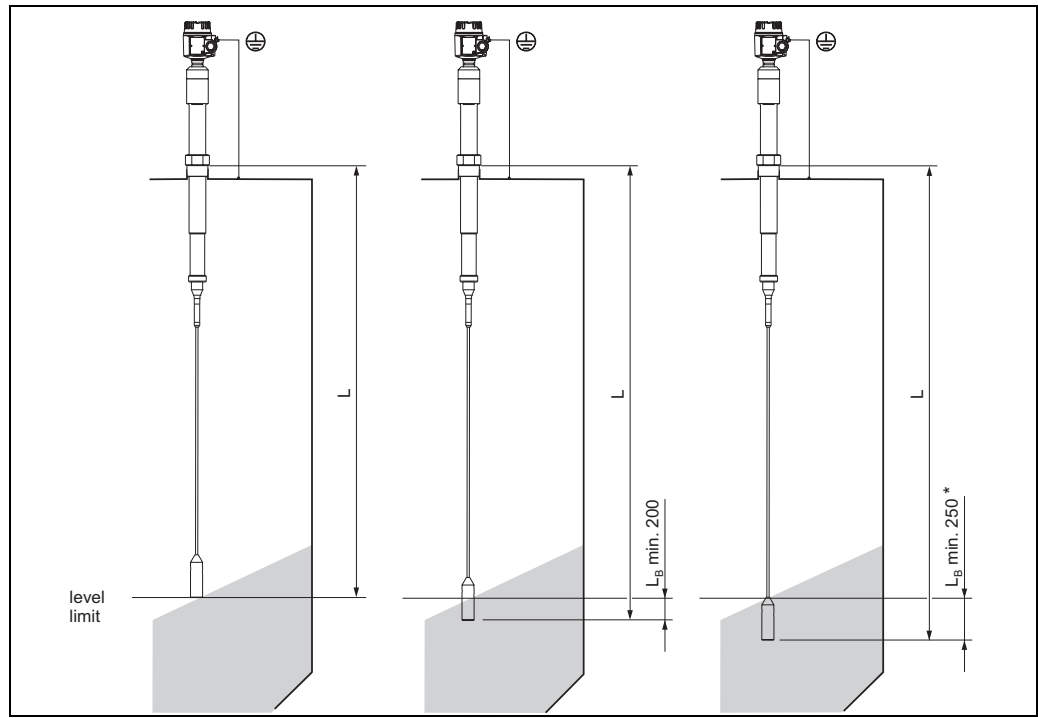

BA381Fer011

Electrically conductive bulk solids (e.g. coal)

Bulk solids with high dielectric constant (e.g. rock salt)

Bulk solids with low dielectric constant (e.g. fly ash)

* L_B (covered length):

For nonconductive bulk solids with a low dielectric constant, the rope probe must be approx. 5 % (but no less than 250 mm) longer than the distance between the tank roof and the required level limit.

3.9.5 Shortening the probe

Sword probe:

The sword probe can be shortened at a later stage by the user.

Rope probe:

The rope probe can be shortened at a later stage by the user.

- Release the set screws at the tensioning weight and remove the rope.
- Shorten the probe rope to the desired length.
- Slide the rope back in, as far as the base of the bore, and secure it using the set screws.

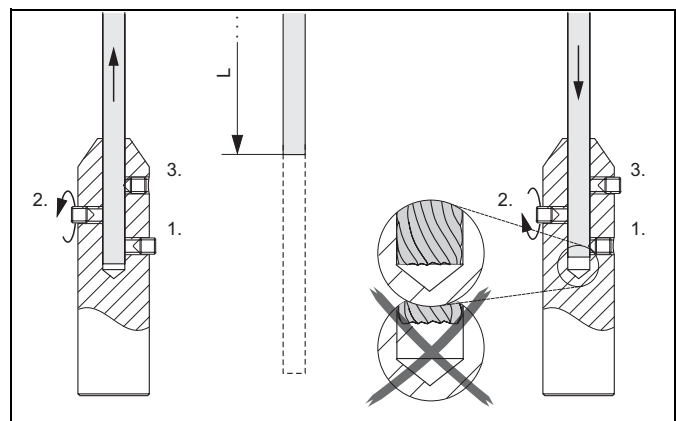

BA381Fer012

3.9.6 Measuring conditions



Note!

- When installing in a nozzle, use inactive length (L3).
- To control a screw conveyor (Δs mode), sword probes and rope probes can be used (only for nonconductive bulk solids). The on-value and off-value are determined by the empty and full calibration.

DK > 10	Measuring range up to 4 m
5 < DK < 10	Measuring range up to 12 m
2 < DK < 5	Measuring range up to 20 m

- The minimum capacitance change for level limit detection must be ≥ 5 pF.

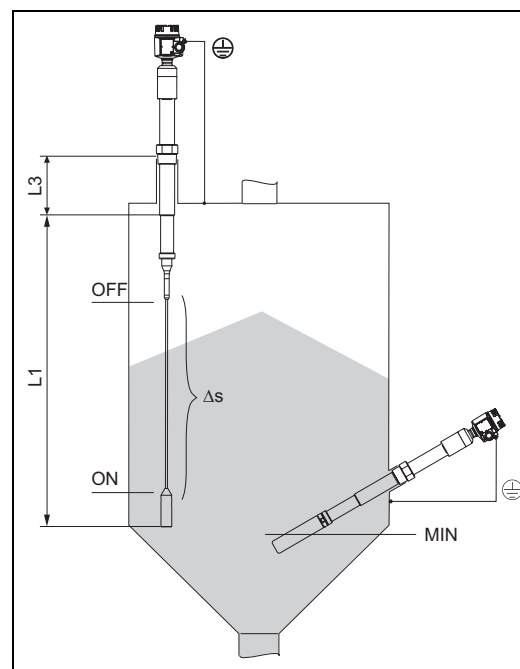

3.10 Installation

3.10.1 Probe with thread

- R 1½ and 1½ NPT (conical):
Where necessary, wrap sealing material around the thread. Ensure that the electrical connection between the probe and the tank is correct.
- If the process connection of the probe is insulated from the metal tank (e.g. using seal material), the ground connection on the probe housing must be connected to the tank using a short line.



Caution!

- Do not damage the ceramic insulation during installation.
- Do not turn the housing while screwing in the probe, as otherwise the housing fixture can be damaged.

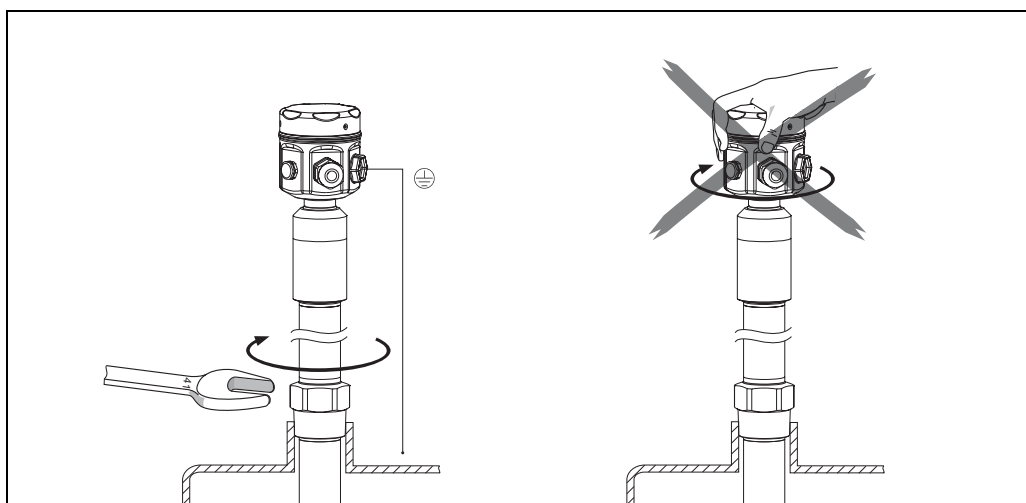

3.10.2 Installation tools

The following tools are required for installation:

- Tool for mounting flanges
- or a size 55 Allen key for the threaded connection
- and a Phillips-head screwdriver for aligning the cable entry.

3.11 With separate housing



Note!

- For information on how to order, see also "Ordering information" from → 10 under "Probe design".
- The maximum connection length between the probe and the separate housing is 6 m (L4).
When ordering a Solicap S with a separate housing, the desired length must be specified.
- If the connecting cable is to be shortened or passed through a wall, it must be separated from the process connection. See also the extension heights → 28.
- The cable has a bending radius of $r \geq 100$ mm. This must be observed as a minimum.

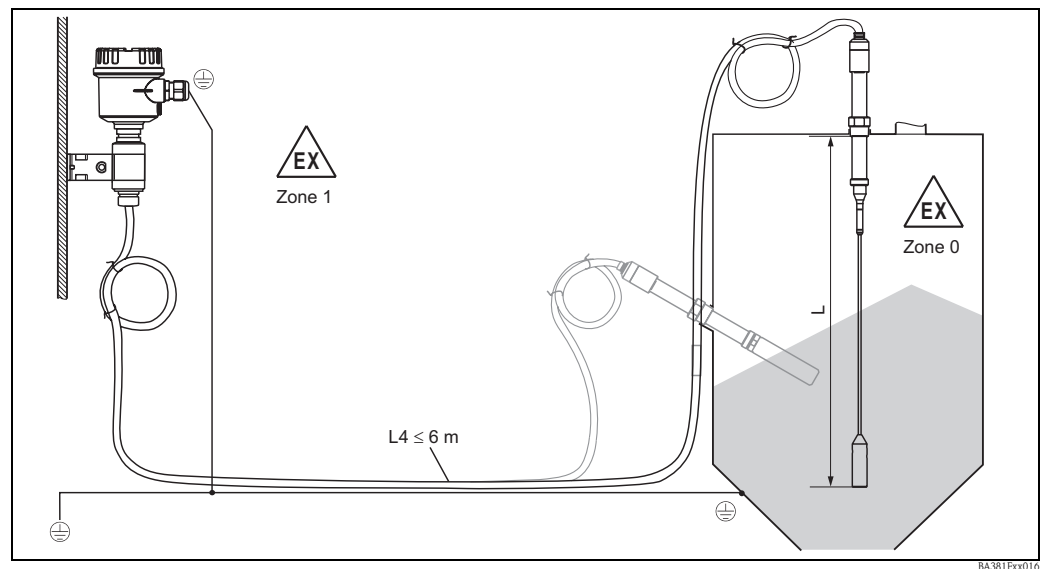

The maximum overall length of $L + L4$ may not exceed 20 m.

3.11.1 Extension heights

Housing side: wall mounting

Housing side: pipe mounting

Sensor side

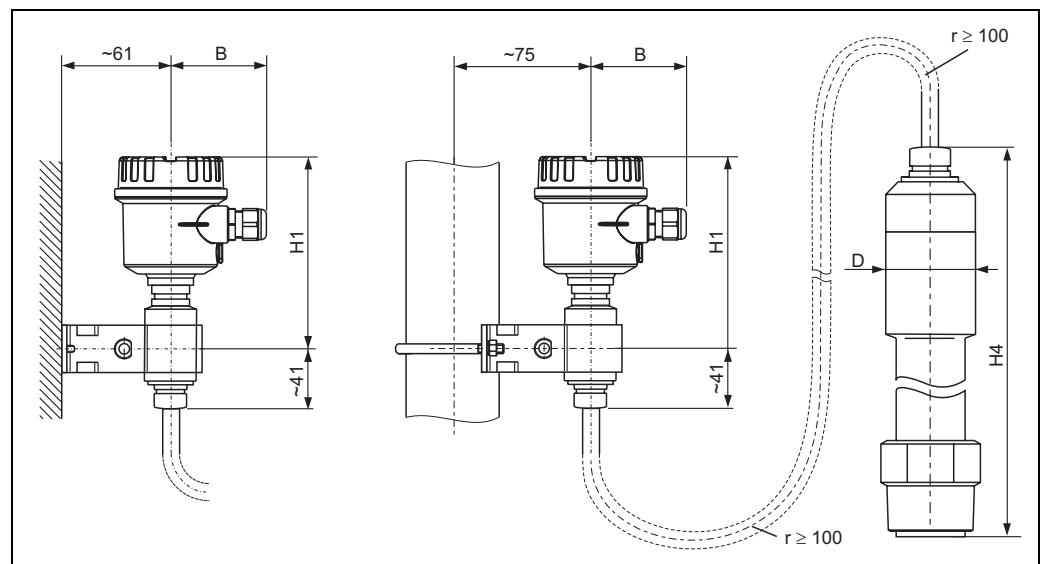

		Polyester housing F16	Stainless steel housing F15	Aluminum housing F17
B	-	76	64	65
H1	-	172	166	177
D	50	-	-	-
H4	330	-	-	-



Note!

- Connecting cable: $\varnothing 10.5$ mm
- Outer jacket: silicone, notch-resistant

3.12 Probe without active buildup compensation

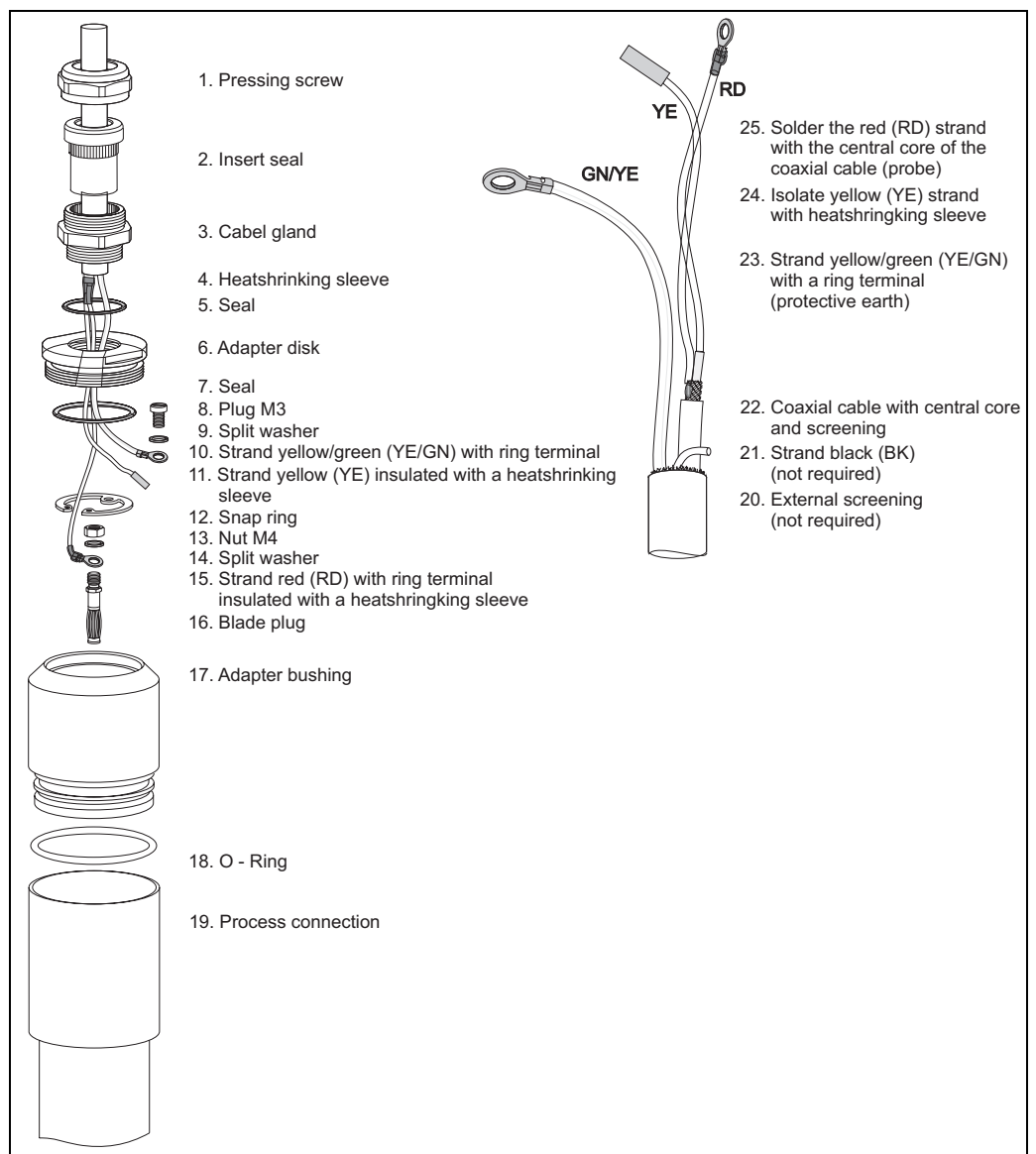

BA381Fen012

3.12.1 Shortening the connecting cable

Full calibration and empty calibration must be performed before commissioning.



Note!

The maximum connection length between the probe and the separate housing is 6 m. When ordering a Solicap S with a separate housing, the desired length must be specified.

If the connecting cable is to be shortened or guided through a wall, it must be disconnected at the process connection. To do so, proceed as follows:

- Unscrew the pressing screw (1) using a 22mm open-end wrench. If necessary, hold the process connection. In doing so, ensure that neither the connecting cable nor the probe is turned in the process.
- Pull the insert seal (2) out of the cable gland (3).
- Using a 22mm open-end wrench, disconnect the cable gland (3) from the adapter disk. If necessary, hold it against the adapter disk (6) using a 34mm open-end wrench.
- Disconnect the adapter disk (6) from the adapter bushing (18).
- Remove the snap ring (12) with a snap ring pliers.
- Grip the nut (M4) on the blade plug with a pliers and pull out the blade plug.
- Then, shorten the connecting cable to the desired length.
- If the separate housing has to be mounted in a different room than the probe, you can now route the connecting cable through the wall.
- You can now reassemble the device by following the reverse order of steps.



Note!

- If you shorten the connecting cable, we recommend reusing all strands with ring terminals.
- If the strands are not to be reused, the crimp connections of the new ring terminals attached must be insulated with a heat-shrinking sleeve tube, for example (danger of short circuit).
- All soldered joints must be insulated. Use heat-shrinking sleeves to do so.

3.13 Probe with active buildup compensation

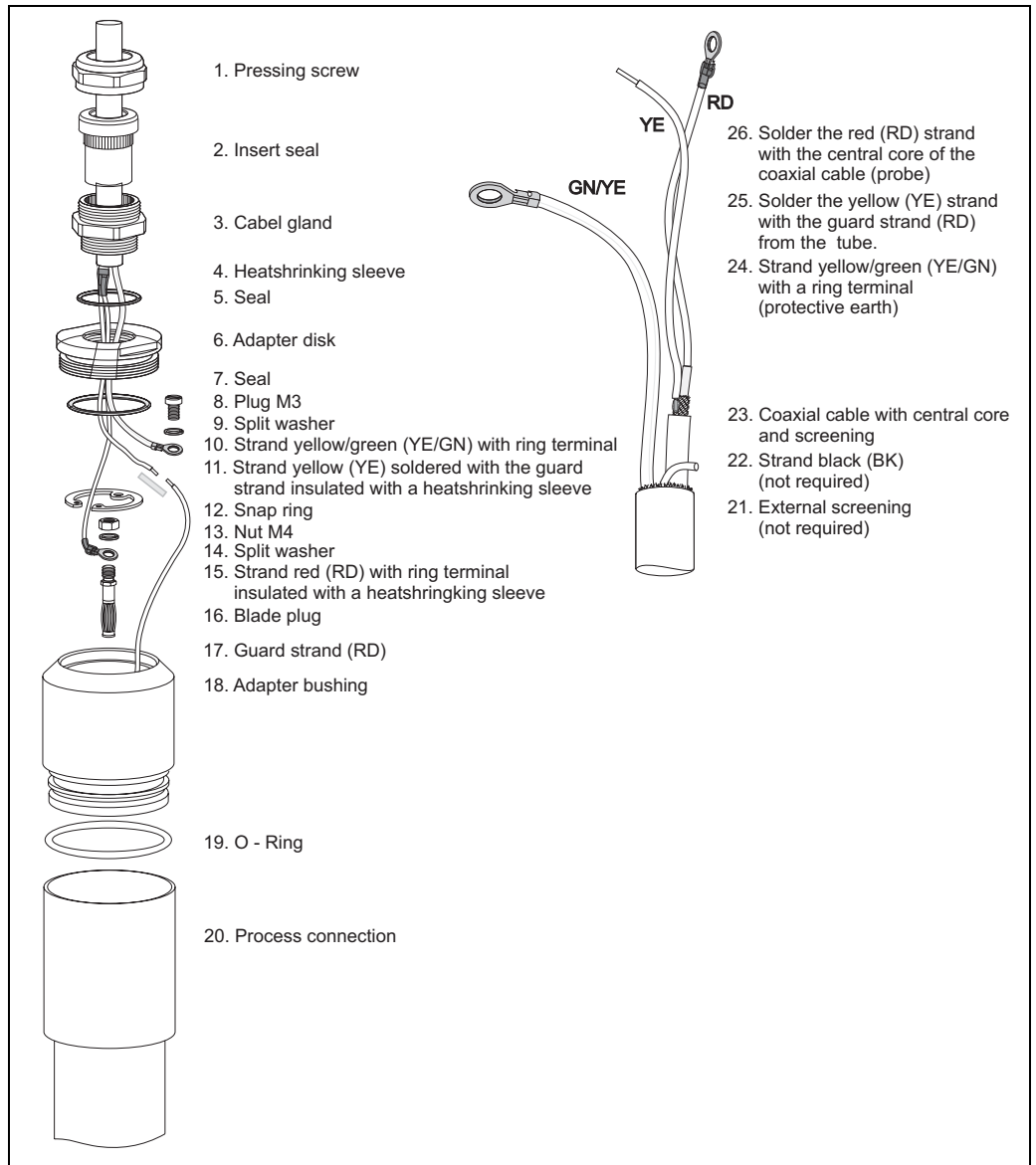

BA381Fen014

3.13.1 Shortening the connecting cable

Full calibration and empty calibration must be performed before commissioning.



Note!

The maximum connection length between the probe and the separate housing is 6 m. When ordering a Solicap S with a separate housing, the desired length must be specified.

If the connecting cable is to be shortened or guided through a wall, it must be disconnected from the process connection. To do so, proceed as follows:

- Unscrew the pressing screw (1) using a 22mm open-end wrench. If necessary, hold the process connection. In doing so, ensure that neither the connecting cable nor the probe is turned in the process.
- Pull the insert seal (2) out of the cable gland (3).
- Using a 22mm open-end wrench, disconnect the cable gland (3) from the adapter disk. If necessary, hold it against the adapter disk (6) using a 34mm open-end wrench.
- Disconnect the adapter disk (6) from the sleeve (17).
- Remove the snap ring (12) with a snap ring pliers.
- Grip the nut (M4) on the blade plug with a pliers and pull out the blade plug.
- Disconnect the yellow strand from the red (guard) strand.
- Then, shorten the connecting cable to the desired length. If the separate housing is in a different room than the probe, you can now route the connecting cable through the wall.
- You can now reassemble the device by following the reverse order of steps.



Note!

- If you shorten the connecting cable, we recommend reusing all strands with ring terminals.
- If the strands are not to be reused, the crimp connections of the new ring terminals attached must be insulated with a heat-shrinking sleeve tube, for example (danger of short circuit).
- All soldered joints must be insulated. Use heat-shrinking sleeves to do so.

3.14 Installing bracket for wall and pipe mounting

3.14.1 Wall holder unit



Note!

- The wall holder unit forms part of the scope of supply.
- The wall holder unit has to be screwed to the separate housing before you can use it as a drilling template. The distance between the holes is reduced by screwing it to the separate housing.

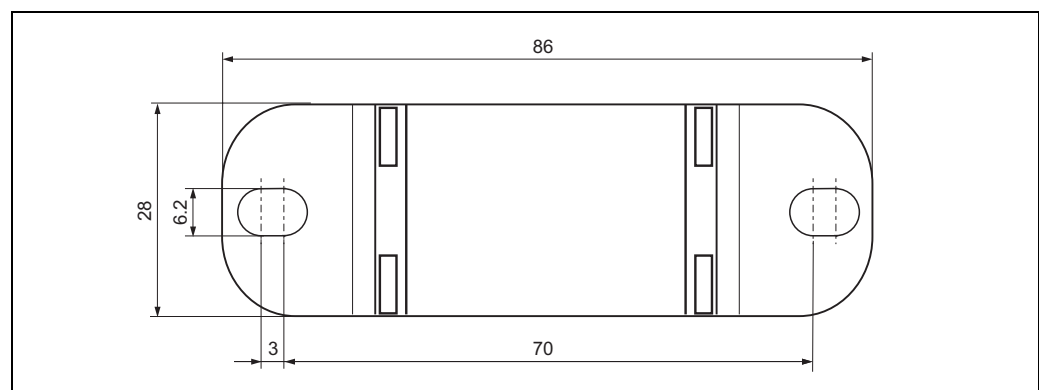

3.14.2 Wall mounting

- Push the bracket onto the sleeve and screw it into place.
- Mark the distance between the holes on the wall, and then drill the holes.
- Screw the separate housing to the wall.

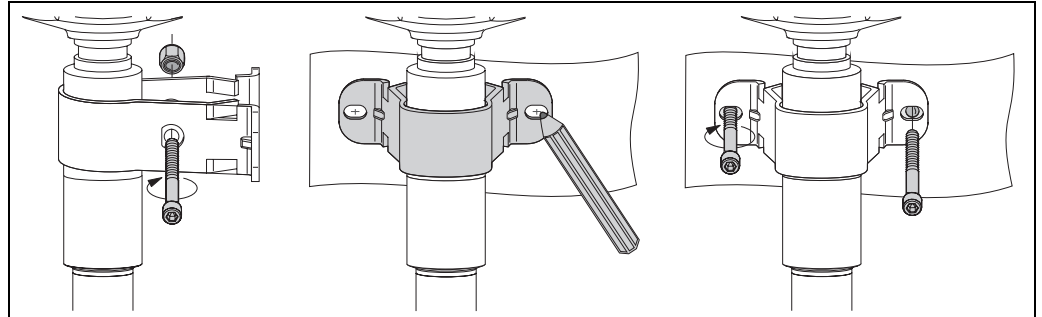

BA381 Fxx018

3.14.3 Pipe mounting

- Push the bracket onto the sleeve and screw it into place.
- Screw the separate housing to the pipe (max. 2").

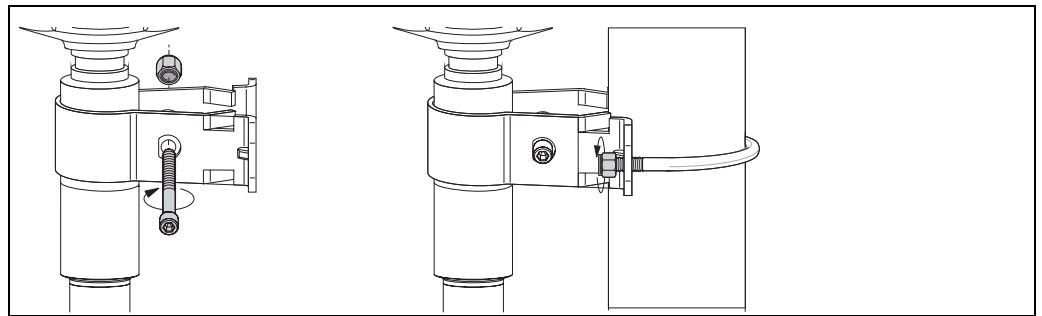

BA381 Fxx019

3.15 Post-installation check

After installing the measuring device, carry out the following checks:

- Is the device damaged (visual inspection)?
- Does the device correspond to the measuring point specifications, including process temperature and pressure, ambient temperature, measuring range, etc.?
- Is the process connection tightened with the correct torque?
- Are the measuring point number and labeling correct (visual inspection)?
- Is the measuring device adequately protected from precipitation and direct sunlight?

4 Wiring



Caution!

Before connecting the supply voltage, note the following:

- The supply voltage must match the information specified on the nameplate (see → 10).
- Switch off the supply voltage before connecting the device.
- Connect the potential equalization to the ground terminal at the sensor.



Note!

- When using the probe in hazardous areas, the relevant national standards and the information in the safety instructions (XA) must be observed.
- Use the specified cable gland only.

4.1 Connection recommendation

4.1.1 Potential equalization

Connect the potential equalization to the outer ground terminal of the housing (T13, F13, F16, F17).

In the case of the stainless steel housing F15, the ground terminal (depending on the version) can also be located in the housing.

For additional safety instructions, refer to the separate documentation for applications in hazardous areas.

4.1.2 Electromagnetic compatibility (EMC)

- Interference emission to EN 61326, Electrical Equipment Class B
- Interference immunity in accordance with EN 61326, Appendix A (Industrial) and NAMUR Recommendation NE 21 (EMC).

4.1.3 Cable specification

The electronic inserts can be connected using the usual commercial instrument cables.

When using shielded instrument cables, it is recommended to connect the shielding on both sides to optimize the shielding effect (if potential equalization present).

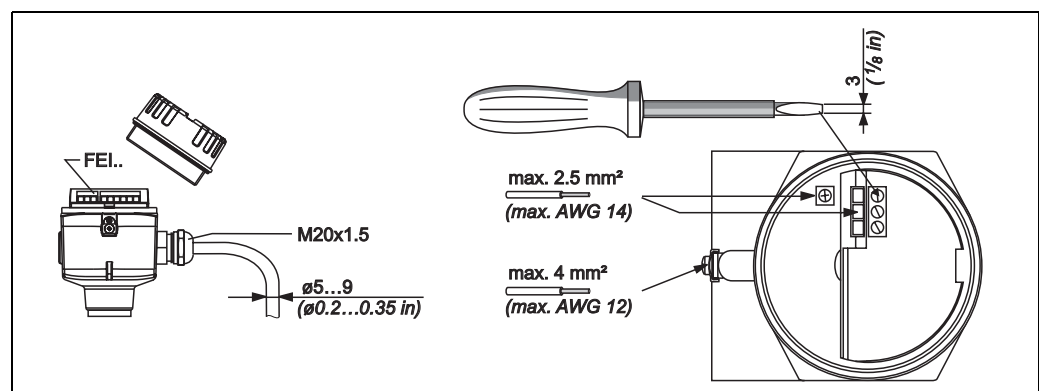

4.1.4 Connector

In the case of the versions with a connector (M12 or 7/8"), the housing does not have to be opened to connect the signal cable.

PIN assignment for the M12 connector (PROFIBUS PA standard, HART)

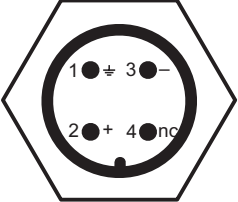
 <p style="text-align: right; font-size: small;">L00-FMxxxxxx-04-00-00-yy-016</p>	PIN	Meaning for FEI52, FEI53	Meaning for FEI55, FEI57S, FEI58
	1	External load/ voltage output	Not assigned
	2	Not assigned	Not assigned
	3	Signal -	Signal -
	4	Signal +	Signal +

PIN assignment for the 7/8" connector (Fieldbus FOUNDATION standard, HART)

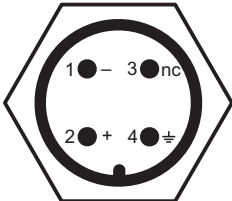
 <p style="text-align: right; font-size: small;">L00-FMxxxxxx-04-00-00-yy-017</p>	PIN	Meaning for FEI52, FEI53	Meaning for FEI55, FEI57S, FEI58
	1	Signal -	Signal -
	2	Signal +	Signal +
	3	External load/ voltage output	Not assigned
	4	Ground	Ground

4.1.5 Cable entry

- Cable gland: M20x1.5 (for EEx d only cable entry M20)
Two cable glands included in scope of delivery.
- Cable entry: G ½, NPT ½, NPT ¾ or M20 thread

4.2 Wiring in housing F16, F15, F17, F13

To connect the electronic insert to the power supply, proceed as follows:

- a. Unscrew the housing cover (1).
- b. Remove the cable gland (2) and insert the cable (3).

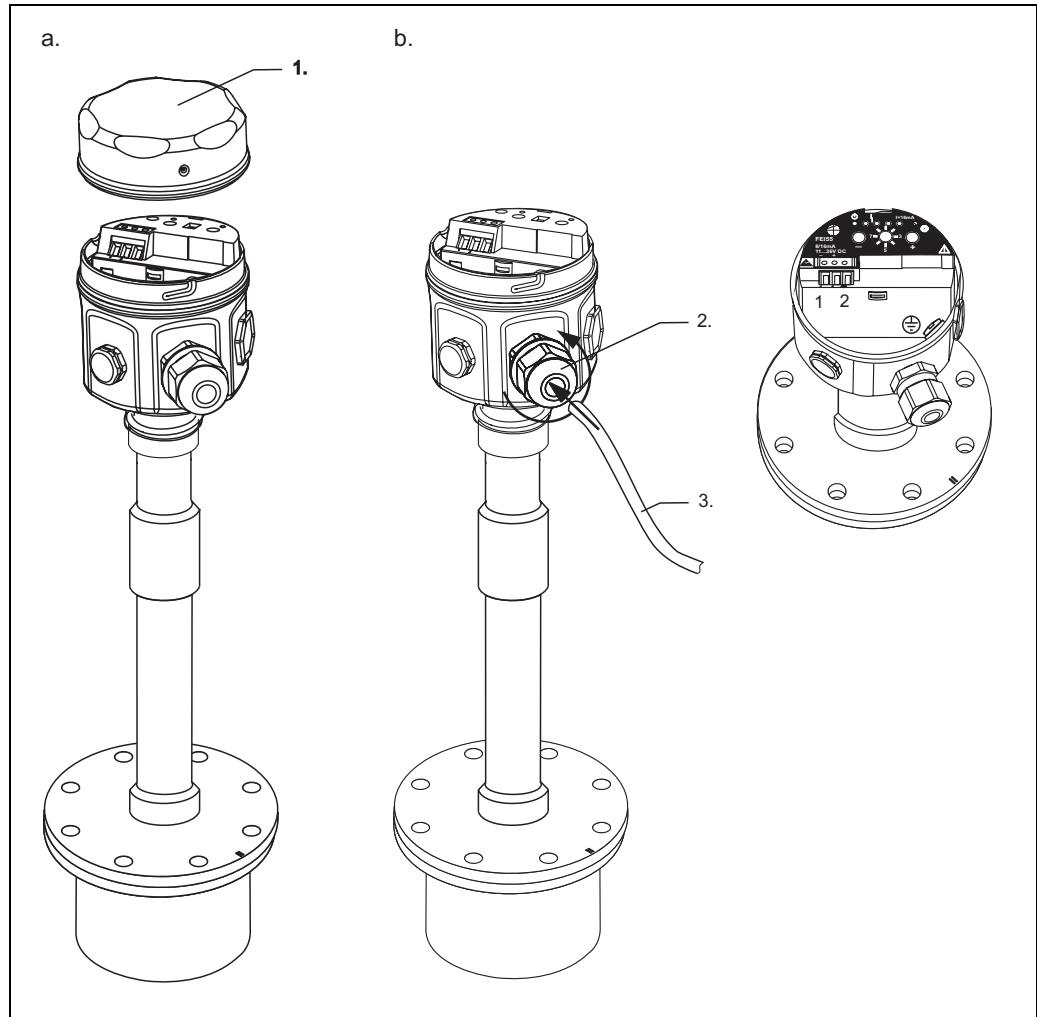

BA381Fxx020



Note!

- Instructions on connecting shielded cables are provided in TI241 "EMC test procedures".
- All further steps depend on the specific electronic inserts used, which are described on the following pages:

FEI51	→	📄	39
FEI52	→	📄	40
FEI53	→	📄	41
FEI54	→	📄	42
FEI55	→	📄	43
FEI57S	→	📄	44
FEI58	→	📄	45

4.3 Wiring in housing T13

To connect the electronic insert to the power supply, proceed as follows:

- a. Unscrew the housing cover (1).
- b. Remove the cable gland (2) and insert the cable (3).

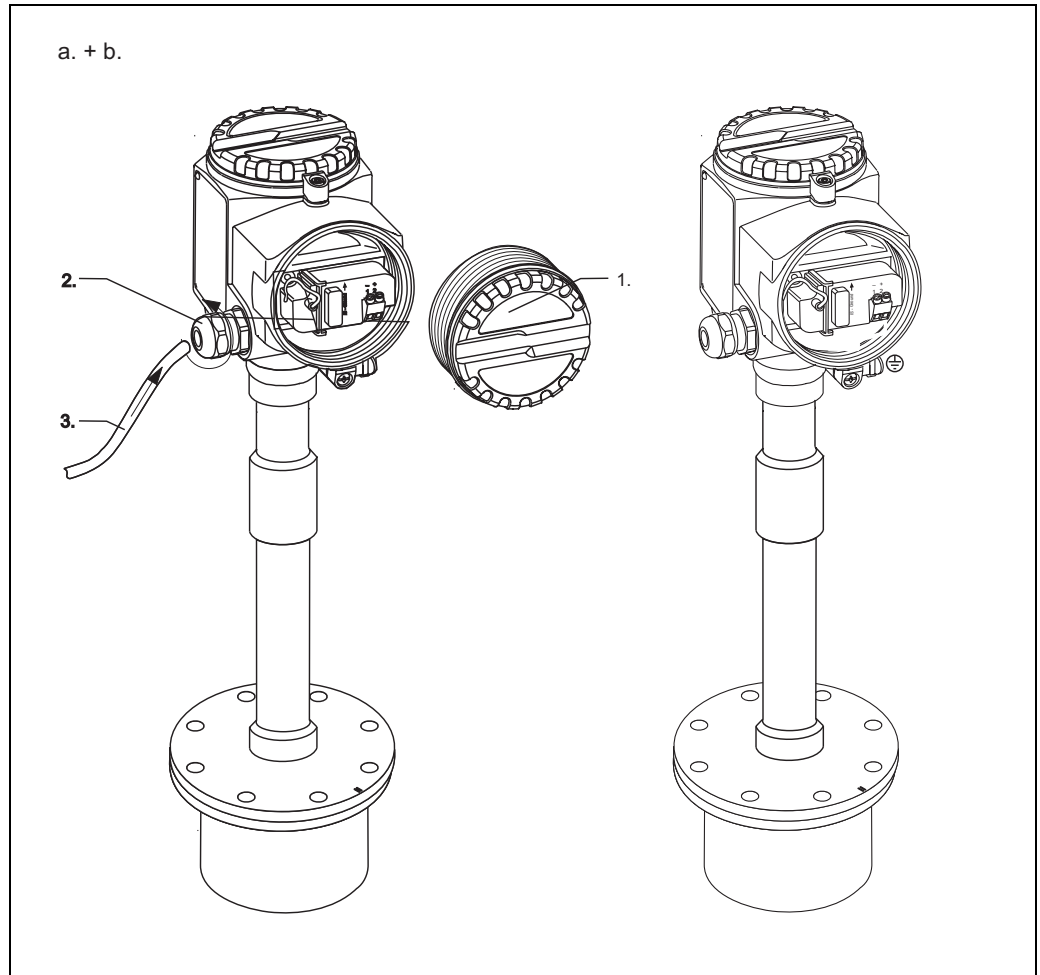

Note!

- To perform connection work in the separate connection compartment, the same connection instructions apply as for the electronic inserts.
- Instructions on connecting shielded cables are provided in TI241 "EMC test procedures".
- All further steps depend on the specific electronic inserts used, which are described on the following pages:
 - FEI51 → 39
 - FEI52 → 40
 - FEI53 → 41
 - FEI54 → 42
 - FEI55 → 43
 - FEI57S → 44
 - FEI58 → 45

4.4 Connecting the device

Connection compartment

Five types of housing are available:

	Standard	EEx ia	Dust ignition-proof	Gas-tight process seal
Polyester housing F16	X	X	–	–
Stainless steel housing F15	X	X	X	–
Aluminum housing F17	X	X	X	–
Aluminum housing F13	X	X	X	X
Aluminum housing T13 (with separate connection compartment)	X	X	X	X

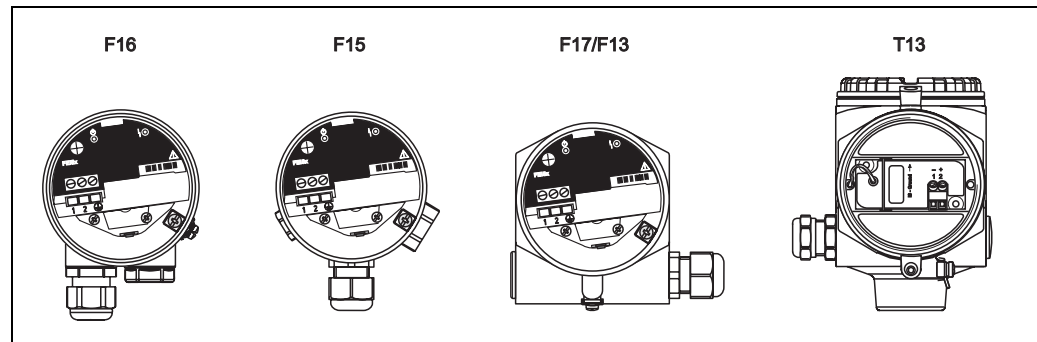

BA300Fxx017



Note!

The nameplate contains important device data.

4.5 Degree of protection

	IP66*	IP67*	IP68*	NEMA4X*
Polyester housing F16	X	X	–	X
Stainless steel housing F15	X	X	–	X
Aluminum housing F17	X	X	–	X
Aluminum housing F13 with gas-tight process seal	X	–	X***	X
Aluminum housing T13 with gas-tight process seal and separate connection compartment (EEx d)	X	–	X***	X
Separate housing	X	–	X***	X

* As per EN60529

** As per NEMA 250

*** Only with M20 cable entry or G1/2 thread

4.6 Electronic insert FEI51 (AC 2-wire)



Note!

Connect in series with an external load.

Power supply

Supply voltage: 19 to 253 V AC

Power consumption: < 1.5 W

Residual current consumption: < 3.8 mA

Short-circuit protection

FEI51 overvoltage protection: overvoltage category II

Signal on alarm

Output signal on power failure or in the event of damage to the sensor: < 3.8 mA

Connectable load

- For relays with a minimum holding power or rated power > 2.5 VA at 253 V AC (10 mA) or > 0.5 VA at 24 V AC (20 mA)
- Relays with a lower holding power or rated power can be operated by means of an RC module connected in parallel.
- For relays with a maximum holding power or rated power < 89 VA at 253 V AC or < 8.4 VA at 24 V AC
- Voltage drop across FEI51 max. 12 V
- Residual current with blocked thyristor max. 3.8 mA
- Load switched directly into the power supply circuit via the thyristor.

Connect the FEI51 (AC 2-wire) as follows:

1. Make the connection as shown in the graphic.
2. Tighten the cable gland.
3. Set the function switch (5) to position 1 (operation).



Note!

Do not switch on the supply voltage until you have familiarized yourself with the device functions as described in Section 5 "Operation". This will ensure that you do not accidentally trigger any processes by switching on the supply voltage.

4. Switch on the supply voltage.

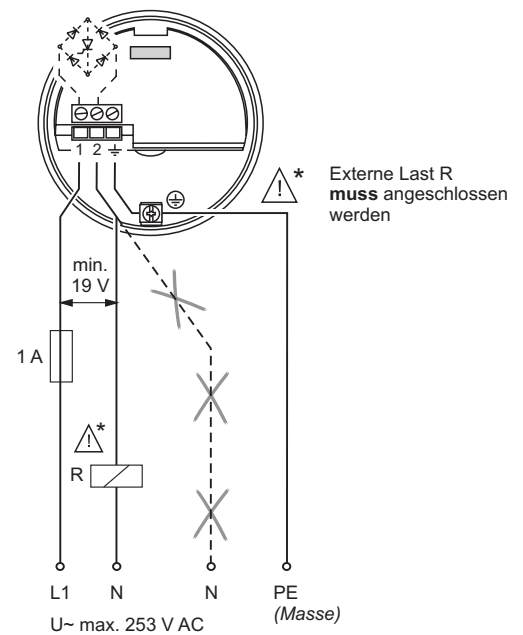

BA381Fen028

4.7 Connecting the electronic insert FEI52 (DC PNP)

The three-wire DC connection should, wherever possible, be connected as follows:

- To programmable logic controllers (PLCs),
- to DI modules in accordance with EN 61131-2

A positive signal is present at the switch output of the electronic system (PNP).

Power supply

Supply voltage: 10 to 55 V DC

Ripple max. 1.7 V; 0 to 400 Hz

Current consumption: < 20 mA

Power consumption without load: max. 0.9 W

Power consumption with full load (350 mA): 1.6 W

Reverse polarity protection: yes

Separation voltage: 3.7 kV

FEI52 overvoltage protection: overvoltage category II

Signal on alarm

Output signal on power failure or in the event of device failure: $I_R < 100 \mu\text{A}$

Connectable load

- Load switched via transistor and separate PNP connection, max. 55 V
- Load current max. 350 mA (cyclical overload and short-circuit protection)
- Residual current < 100 μA (with transistor blocked)
- Capacitive load max. 0.5 μF at 55 V; max. 1.0 μF at 24 V
- Residual voltage < 3 V (for transistor switched through)

Connect the FEI52 (DC PNP) as follows:

1. Make the connection as shown in the graphic.
2. Turn the cable gland until tight.
3. Set the function switch to position 1 (operation).



Note!

Do not switch on the supply voltage until you have familiarized yourself with the device functions as described on Page 46 "Operation". This will ensure that you do not accidentally trigger any processes by switching on the supply voltage.

4. Switch on the supply voltage.

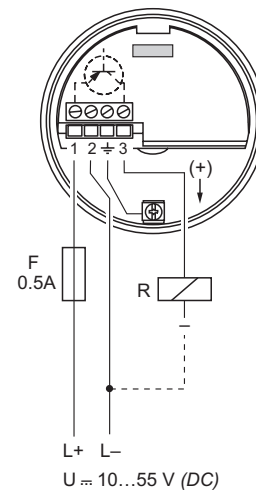

BA381Fxx031

* R = External load ($I_{\text{max.}}$ 350 mA, U_{max} 55 V DC)

4.8 Connecting the electronic insert FEI53 (3-WIRE)

The 3-wire DC connection is used in conjunction with the Nivotester switching device FTC325 3-WIRE from Endress+Hauser; the switching device's communication signal operates at 3 to 12 V.

The changeover of fail-safe mode (MIN) / (MAX) and the level limit calibration take place on the Nivotester.

Power supply

Supply voltage: 14.5 V DC
 Current consumption: < 15 mA
 Power consumption: max. 230 mW
 Reverse polarity protection: yes
 Separation voltage: 0.5 kV

Signal on alarm

Voltage at terminal 3 vis-à-vis terminal 1: < 2.7 V

Connectable load

- Floating relay contacts in the connected switching unit Nivotester FTC325 3-WIRE
- For the contact load capacity, refer to the technical data of the switching device.

Connect the FEI53 (3-WIRE) as follows:

1. Make the connection as shown in the graphic.
2. Turn the cable gland until tight.



Note!

Do not switch on the supply voltage until you have familiarized yourself with the device functions as described on Page 46 "Operation". This will ensure that you do not accidentally trigger any processes by switching on the supply voltage.

3. Switch on the supply voltage.

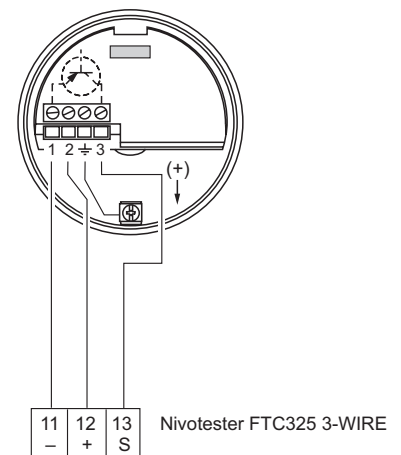

BA381Fxx060

4.9 Connecting the electronic insert FEI54 (AC/DC with relay output)

The universal voltage connection with relay output (DPDT) operates in two different voltage ranges (AC and DC).



Note!

When connecting devices with high inductivity, use a spark suppression system to protect the relay contacts.

Power supply

Supply voltage: 19 to 253 V AC, 50/60 Hz or 19 to 55 V DC

Power consumption: max. 1.6 W

Reverse polarity protection: yes

Separation voltage: 3.7 kV

FEI54 overvoltage protection: overvoltage category II

Signal on alarm

Output signal on power failure or in the event of device failure: relay de-energized

Connectable load

- Loads switched via 2 floating changeover contacts (DPDT)
- I~ max. 6 A; U~ max. 253 V; P~ max. 1500 VA at $\cos \varphi = 1$;
P~ max. 750 VA at $\cos \varphi > 0.7$
- I- max. 6 A to 30 V; I- max. 0.2 A to 125 V
- When connecting a functional extra-low voltage circuit with dual insulation in accordance with IEC 1010, the following applies: The sum of the voltages of the relay output and power supply must not exceed 300 V.

Connect the FEI54 (AC/DC relay) as follows:

1. Make the connection as shown in the graphic.
2. Turn the cable gland until tight.
3. Set the function switch to position 1 (operation).



Note!

Do not switch on the supply voltage until you have familiarized yourself with the device functions as described on Page 46 "Operation". This will ensure that you do not accidentally trigger any processes by switching on the supply voltage.

4. Switch on the supply voltage.

* Refer also to Connectable load

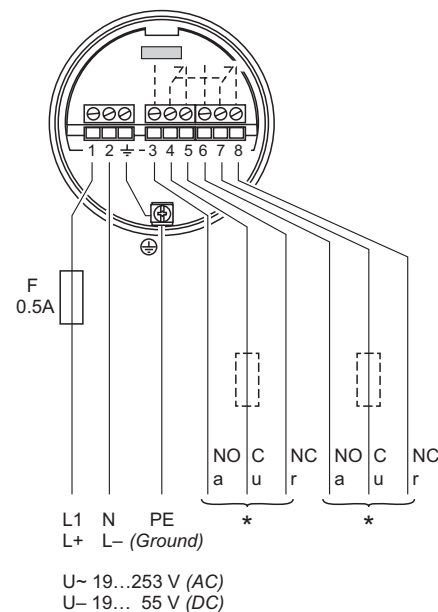

BA381Fxx001

4.10 Connecting the electronic insert FEI55 (8/16 mA, SIL2/SIL3)

The two-wire DC connection should, if possible, be connected as follows:

- to programmable logic controllers (PLCs),
- to AI modules 4 to 20 mA in accordance with EN 61131-2

The level limit signal is sent via an output signal jump from 8 mA to 16 mA.

Power supply

Supply voltage: 11 to 36 V DC

Power consumption: < 600 mW

Reverse polarity protection: yes

Separation voltage: 0.5 kV

Signal on alarm

Output signal on power failure or in the event of device failure: < 3.6 mA

Connectable load

- U = connection DC voltage:
 - 11 to 36 V DC (non-hazardous area and Ex ia)
 - 14.4 to 30 V DC (Ex d)
- $I_{\max} = 16 \text{ mA}$

Functional safety (SIL)

The electronic insert FEI55 meets the requirements of SIL2/SIL3 according to IEC 61508/IEC 61511-1 and can be used in safety systems with such requirements.

Functional safety requirements are listed in document SD278F/00.

NAMUR Recommendation

Electronic insert FEI55 satisfies NAMUR Recommendation NE 43.

Connect the FEI55 (8/16 mA) as follows:

1. Make the connection as shown in the graphic.
2. Turn the cable gland until tight.
3. Set the function switch to position 1 (operation).

 **Note!**

Do not switch on the supply voltage until you have familiarized yourself with the device functions as described on Page 46 "Operation". This will ensure that you do not accidentally trigger any processes by switching on the supply voltage.

4. Switch on the supply voltage.

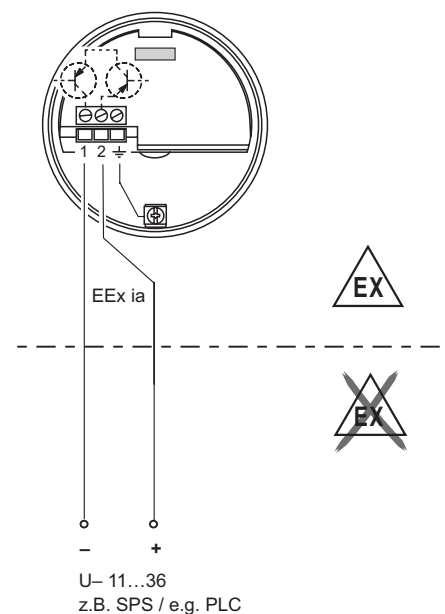

4.11 Connecting the electronic insert FEI57S (PFM)

The two-wire DC connection is used in conjunction with one of the following Nivotester switching devices from Endress+Hauser:

- FTC325 PFM,
- FTC625 PFM (from SW V1.4),
- FTC470Z,
- FTC471Z

The PFM signal is between 17 and 185 Hz.

The changeover of fail-safe mode (MIN) / (MAX) and the level limit calibration take place on the Nivotester.

Power supply

Supply voltage: 9.5 to 12.5 V DC

Power consumption: < 150 mW

Reverse polarity protection: yes

Separation voltage: 0.5 kV

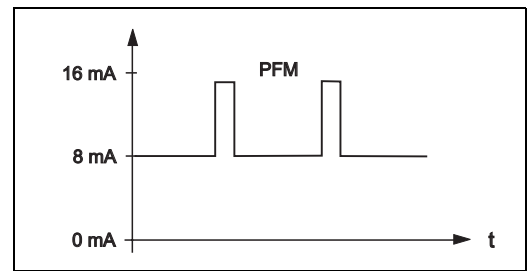

TI418FS2

Frequency: 17 to 185 Hz

Output signal

PFM 17 to 185 Hz (Endress+Hauser)

Connectable load

- Floating relay contacts in the connected switching unit Nivotester FTC325 PFM, FTC625 PFM (from SW V1.4), FTC470Z, FTC471Z
- For the contact load capacity, refer to the technical data of the switching device.

Connect the FEI57 (PFM) as follows:

1. Make the connection as shown in the graphic.
2. Turn the cable gland until tight.

 **Note!**

Do not switch on the supply voltage until you have familiarized yourself with the device functions as described on Page 46 "Operation". This will ensure that you do not accidentally trigger any processes by switching on the supply voltage.

3. Switch on the supply voltage.

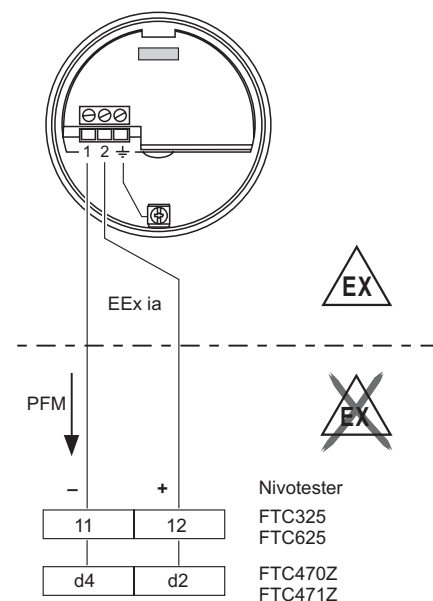

BA381Fxx063

4.12 Connecting the electronic insert FEI58 (NAMUR)

The two-wire connection for a separate switching unit in accordance with NAMUR specifications (IEC 60947-5-6), e.g. FXN421, FXN422, FTL325N, FTL375N from Endress+Hauser. Change in output signal from high to low current in event of limit detection.

(H-L edge)

Additional function:

Test key on the electronic insert.

Pressing the key breaks the connection to the isolating amplifier.



Note!

In the case of Ex-d operation, the additional function can only be used if the housing is not exposed to an explosive atmosphere.

When connecting to Multiplexer: set 3 s as the cycle time at least.

Power supply

Power consumption: < 6 mW at $I < 1$ mA; < 38 mW at $I = 2.2$ to 4 mA

Interface connection data: IEC 60947-5-6

Signal on alarm

Output signal in the event of damage to the sensor: < 1.0 mA

Connectable load

- See the technical data of the connected isolating amplifier as per IEC 60947-5-6 (NAMUR)
- Connection also to isolating amplifiers which have special safety circuits ($I > 3.0$ mA)

Connect the FEI58 (NAMUR) as follows:

1. Make the connection as shown in the graphic.
2. Turn the cable gland until tight.



Note!

Do not switch on the supply voltage until you have familiarized yourself with the device functions as described on Page 46 "Operation". This will ensure that you do not accidentally trigger any processes by switching on the supply voltage.

3. Switch on the supply voltage.

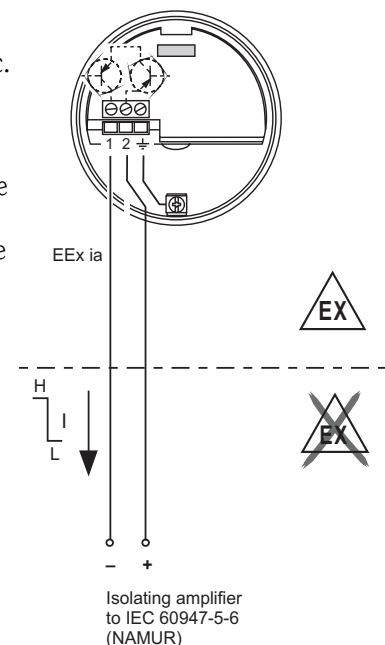

100-FTL5xxxx-04-05-xx-en-002

4.13 Post-connection check

After wiring the measuring device, carry out the following checks:

- Is the terminal assignment correct?
- Is the cable gland tightly sealed?
- Is the housing cover screwed on all the way?
- If a power supply is present: If the device is operational, the green LED flashes at 5-second intervals.

5 Operation

5.1 Human interface and display elements for FEI51, FEI52, FEI54, FEI55

You can operate the electronic inserts FEI51, FEI52, FEI54 and FEI55 via the function switch (A) and the keys "-" (B) and "+" (C).

The function switch A has eight possible positions. Each position has at least one function. The operating status of the device is indicated by light emitting diodes (LEDs 1 to 6) on the electronic insert and depends on the position of the function switch.

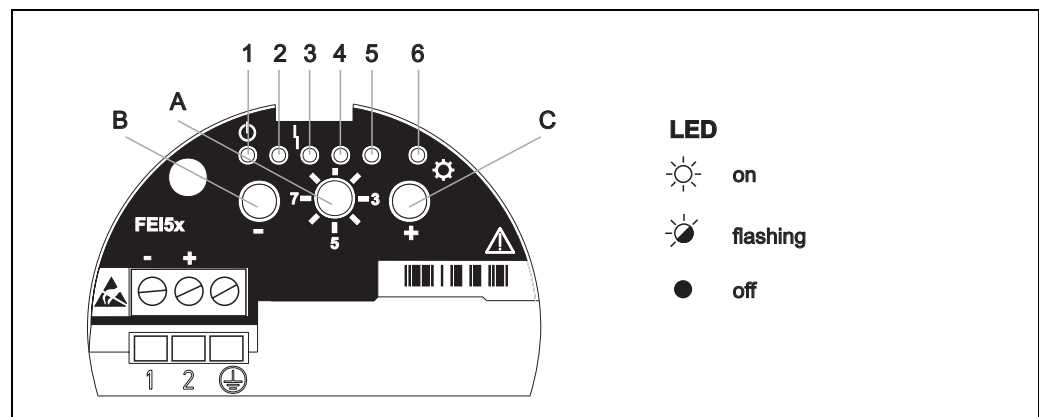









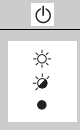

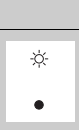

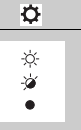
Green LED 1 (⏻ operational), red LED 2 (⚡ fault), yellow LED 3 (⚙ switching state)



Note!

To select a function, press the keys (- and/or +) for at least 2 seconds. Release the keys when the LED signals change.

Function switch setting	Function	- key	+ key	Light emitting diodes (LED signals)					
									
A		B	C	1 (green)	2 (green)	3 (red)	4 (green)	5 (green)	6 (yellow)
1 	Operation			Flashes Operational LED	On*** (MIN-SIL)	Flashes (warning/ alarm)	On*** (MAX-SIL)		On/off/ flashes**
	Restore factory setting	Press both keys for approx. 20 s		On	->	->	->	->	**
2 	Empty calibration	Press		On (present)					**
	Full calibration		Press					On (present)	**
	Reset: Calibration and switchpoint adjustment	Press both keys for approx. 10 s		On	->	->	->	->	**
3 	Switchpoint adjustment	Press for <	Press for >	On * (2 pF)	Off (4 pF)	Off (8 pF)	Off (16 pF)	Off (32 pF)	**
4 	Measuring range	Press for <		On * (500 pF)	Off (1600 pF)				**
	Two-point control ΔS		Press once					On	
	buildup mode		Press twice				On	On	**
5 	Switching delay	Press for <	Press for >	Off (0.3 s)	On * (1.5 s)	Off (5 s)	Off (10 s)		**
6 	Self-test (function test)	Press both keys		Off * (inactive)				Flashes (active)	**
7	MIN-/MAX Fail-safe mode	Press for MIN	Press for MAX	Off (MIN)				On * (MAX)	**
	Lock/unlock SIL mode***	Press both keys			On (MIN-SIL)		On (MAX-SIL)		
8 	Upload/download Sensor DAT (EEPROM)	Press for download	Press for upload	Flashes (download)				Flashes (upload)	**

* These settings are factory settings.

** Switch status signaling (on/off/flashing) depends on the mounting location selected and the fail-safe mode (MIN/MAX) set.
The LED flashes if a calibration has not yet been carried out.

*** Only in conjunction with electronic insert FEI55 (SIL). The device is in the SIL mode. To change the current settings, the device must be unlocked → Page 61.

5.2 Human interface and display elements for FEI53, FEI57S

The electronic inserts FEI53 and FEI57S are used in conjunction with Nivotester switching devices. The functions of the DIP switches (A and B) and the LEDs (1 and 2) are described in the table below.

The operating status of the device is indicated by LEDs (LED 1 and 2) on the electronic insert and provides information on operational readiness (1) and, where applicable, the type of fault (2).

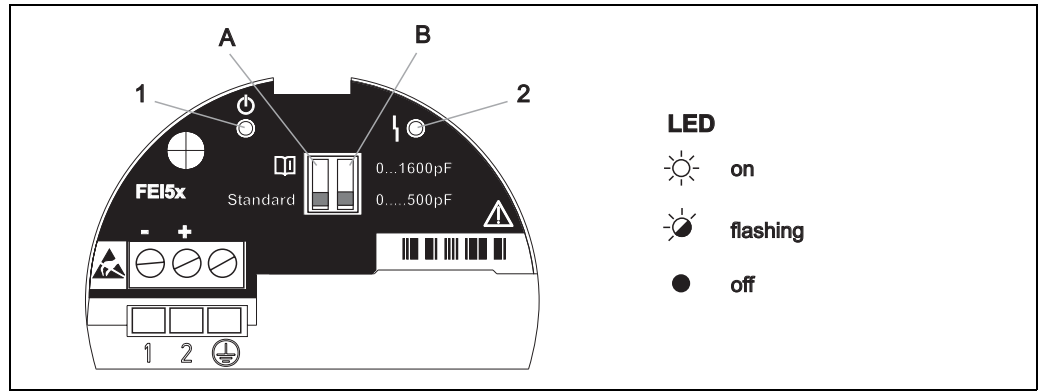

LED 1 operational ☉: Flashes at 5-second intervals.

LED 2 fault ⚡: The red LED flashes if there is a fault that you can correct.

LED 2 fault ⚡: The red LED lights up continuously if the device has a fault that cannot be corrected. See also → 76, "Troubleshooting".



Note!

A description of the human interface and display elements of the Nivotester switching device is provided in the documentation that accompanies the device.

DIP switch	Function
A Standard	Standard ¹⁾ : If the measuring range is exceeded no alarm is output.
A	: If the measuring range is exceeded an alarm is output.
B 0...500pF	Measuring range: The measuring range is between 0 to 500 pF. Span: The span is between 5 to 500 pF.
B 0...1600pF	Measuring range: The measuring range is between 0 to 1600 pF. Span: The span is between 5 to 1600 pF.

5.3 Human interface and display elements for FEI58

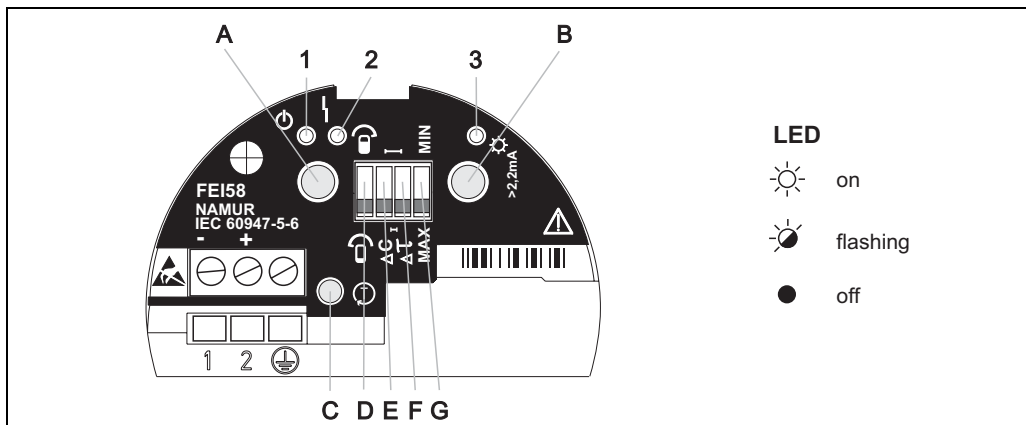

BA299Fen016

Green LED 1 (ⓘ operational), red LED 2 (⚡ fault), yellow LED 3 (⚡ switching state)

DIP switches (C, D, E, F)		Function
D		The probe is covered during calibration.
D		The probe is uncovered during calibration.
E		Switchpoint adjustment: 10 pF
E		Switchpoint adjustment: 2 pF
F		Switching delay: 5 s
F		Switching delay: 1 s
G		Fail-safe mode: MIN The output switches safety-oriented when the probe is uncovered (signal on alarm). For use for dry running protection and pump protection for example
G		Fail-safe mode: MAX The output switches safety-oriented when the probe is covered (signal on alarm). For use with overflow protection for example

Key			Function
A	B	C	
X			Display diagnostic code
	X		Display calibration situation
X	X		Perform calibration (during operation)
X	X		Delete calibration points (during startup)
		X	Test key ⓘ, (disconnects the transmitter from the switching unit)

6 Commissioning

6.1 Installation and function check

Make sure that the post-installation check and final check have been completed before you start your measuring point:

- For the "Post-installation" checklist, refer to → 33.
- For the "Post-connection" checklist, refer to → 46.

6.2 Commissioning the electronic inserts FEI51, FEI52, FEI54, FEI55

This section describes how to commission the device with electronic insert versions FEI51, FEI52, FEI54, FEI55.



Note!

- When you start up the device for the first time, the output is in safe status. This is signaled by the flashing yellow LED 6.
- The device is not operational until you have carried out a calibration. To attain maximum operational safety, carry out an empty and a full calibration. This is particularly recommended for critical applications.





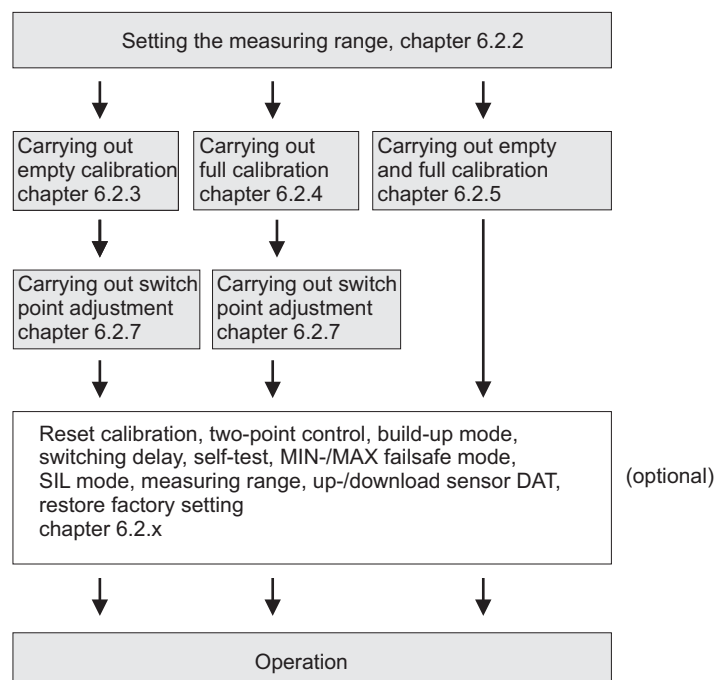

Refer to the following subchapters for information on how to carry out the calibration.

6.2.1 Basic settings: overview

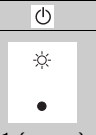

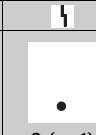
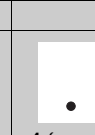
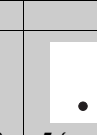
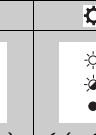
BA381Fen027

6.2.2 Setting the measuring range

Function switch setting	Function	- key	+ key	Light emitting diodes (LED signals)					
									
 A		 B	 C	1 (green)	2 (green)	3 (red)	4 (green)	5 (green)	6 (yellow)
4	Measuring range	Press for <		On * (500 pF)	Off (1600 pF)				**

* These settings are factory settings.

** Switch status signaling (on/off/flashing) depends on the mounting location selected and the fail-safe mode (MIN/MAX) set. The LED flashes if a calibration has not yet been carried out.



Note!

- The choice of measuring range (0 to 500 pF and 0 to 1600 pF) depends on the function of the probe.
- If the probe is used as a limit switch, you can retain the factory setting of 0 to 500 pF.
- If the probe is used for two-point control, the following recommendations apply for vertical installation:
 - Measuring range from 0 to 500 pF for probe lengths up to 1 m
 - Measuring range from 0 to 1600 pF for probe lengths up to 20 m

















Partially insulated probes are only suitable for nonconductive bulk solids (see also →  74).

To set the range to 0 to 1600 pF, proceed as follows:

1. Turn the function switch to position 4.
2. Press the "-" key for at least 2 seconds until the green LED 2 lights up.
3. Release the "-" key when the green LED 2 lights up.

Turn the function switch to position 2 to continue the calibration.

6.2.3 Carrying out empty calibration

Function switch setting	Function	- key	+ key	Light emitting diodes (LED signals)					
									
 A		 B	 C	 1 (green)	 2 (green)	 3 (red)	 4 (green)	 5 (green)	 6 (yellow)
2 	Empty calibration	Press		On (present)					**

** Switch status signaling (on/off/flashing) depends on the mounting location selected and the fail-safe mode (MIN/MAX) set. The LED flashes if a calibration has not yet been carried out.



Note!

















- The empty calibration stores the capacitance value of the probe when the tank is empty. If the measured capacitance value is, for example, 50 pF (empty calibration), a switching threshold of 2 pF is added to this value. The capacitance value of the switchpoint would, in this case, be 52 pF.
- The switching threshold depends on the value set for the switchpoint adjustment (for more information, see Page 56).

To carry out an empty calibration, proceed as follows:

1. Check to make sure that the probe is not covered with product.
2. Turn the function switch to position 2.
3. Press the "-" key for at least two seconds.
4. Release the "-" key when the green LED 1 starts to flash.

The process of saving the empty calibration is finished when the green LED 1 lights up continuously. You can turn the function switch back to position 1 to return to operation.

6.2.4 Carrying out the full calibration

Function switch setting	Function	- key	+ key	Light emitting diodes (LED signals)					
									
 A		 B	 C	 1 (green)	 2 (green)	 3 (red)	 4 (green)	 5 (green)	 6 (yellow)
2 	Full calibration		Press					On (present)	**

** Switch status signaling (on/off/flashing) depends on the mounting location selected and the fail-safe mode (MIN/MAX) set. The LED flashes if a calibration has not yet been carried out.



Note!

















- The full calibration measures the capacitance value of the probe when the tank is full. If the measured capacitance value is, for example, 100 pF (full calibration), a switching threshold of 2 pF is subtracted from this value. The capacitance value of the switchpoint is thus 98 pF.
- The switching threshold depends on the value set for the switchpoint adjustment (for more information, see Page 56).

To carry out a full calibration proceed as follows:

1. Make sure that the probe is covered by the medium up to the desired switchpoint.
2. Turn the function switch to position 2.
3. Press the "+" key for at least two seconds.
4. Release the "+" key when the green LED 5 starts to flash.

The process of saving the full calibration is complete when the green LED 5 lights up continuously. You can turn the function switch back to position 1 to return to operation.

6.2.5 Carrying out the empty and full calibration

Function switch setting	Function	- key	+ key	Light emitting diodes (LED signals)					
									
 A		 B	 C	 1 (green)	 2 (green)	 3 (red)	 4 (green)	 5 (green)	 6 (yellow)
2 	Empty calibration	Press		On (present)					**
2 	Full calibration		Press					On (present)	**

** Switch status signaling (on/off/flashing) depends on the mounting location selected and the fail-safe mode (MIN/MAX) set.
The LED flashes if a calibration has not yet been carried out.



Note!

- An empty and full calibration provides the greatest possible operational security. This is particularly recommended for critical applications.
- The empty and full calibration measures the capacitance values of the probes when the tank is full and when it is empty. If, for example, the measured capacitance value of the empty calibration is 50 pF and that of the full calibration is 100 pF, the average capacitance value, 75 pF, is stored as the switchpoint.

To carry out an **empty calibration**, proceed as follows:

1. Check to make sure that the probe is not covered with product.
2. Turn the function switch to position 2.
3. Press the "-" key for at least two seconds.
4. Release the "-" key when the green LED 1 starts to flash.









The process of saving the empty calibration is finished when the green LED 1 lights up continuously. You can turn the function switch back to position 1 to return to operation.

To carry out a **full calibration**, proceed as follows:

1. Make sure that the probe is covered by the medium up to the desired switchpoint.
2. Turn the function switch to position 2.
3. Press the "+" key for at least two seconds.
4. Release the "+" key when the green LED 5 starts to flash.

The process of saving the full calibration is complete when the green LED 5 lights up continuously. You can turn the function switch back to position 1 to return to operation.

6.2.6 Reset: Calibration and switchpoint adjustment

Function switch setting	Function	- key	+ key	Light emitting diodes (LED signals)					
									
 A		 B	 C	1 (green)	2 (green)	3 (red)	4 (green)	5 (green)	6 (yellow)
2	Reset: Calibration and switchpoint adjustment	Press both keys for approx. 10 s		On	->	->	->	->	**

** Switch status signaling (on/off/flashing) depends on the mounting location selected and the fail-safe mode (MIN/MAX) set.
The LED flashes if a calibration has not yet been carried out.

















To reset the calibration/switch-point shift (all the other settings remain unchanged), proceed as follows:

1. Turn the function switch to position 2.
2. Press both the "-" and "+" keys for at least 10 seconds.
3. The green LEDs 1-5 light up in succession.

The reset calibration has been carried out and saved. The yellow LED 6 flashes.
The device is not operational until you have carried out a new calibration.

The switchpoint adjustment is reset to the factory setting of 2 pF.

6.2.7 Setting the switchpoint adjustment

Function switch setting	Function	- key	+ key	Light emitting diodes (LED signals)					
									
 A									
3 	Switchpoint adjustment	Press for <	Press for >	On * (2 pF)	Off (4 pF)	Off (8 pF)	Off (16 pF)	Off (32 pF)	**

* These settings are factory settings.

** Switch status signaling (on/off/flashing) depends on the mounting location selected and the fail-safe mode (MIN/MAX) set. The LED flashes if a calibration has not yet been carried out.



Note!

















- If only one calibration (empty or full) was carried out, and if buildup forms on the sword probe while the probe is in operation, the device may no longer respond to changes in level. A switchpoint adjustment (e.g. 4, 8, 16, 32 pF) compensates for this condition and ensures that you obtain a constant switchpoint again.
- For media that do not have a tendency to build up, we recommend a setting of 2 pF, as the probe is most sensitive to changes in level at this setting.
- For media with heavy buildup (e.g. plaster), we recommend using probes with active buildup compensation.
- A switchpoint adjustment can be carried out only if a full **or** empty calibration has been carried out first.
- A switchpoint adjustment is not possible if an empty **and** a full calibration have been carried out.
- The switchpoint adjustment is disabled if you switch on the two-point control (as described on Page 57).

To adjust the switchpoint, proceed as follows:

1. Turn the function switch to position 3.
The green LED 1 lights up (factory setting).
2. Press the "+" key for at least two seconds to switch to the next higher value. If you press and hold down the "+" or "-" key, the value changes to the next one every two seconds. The active value is indicated by an LED (1 to 5).

After you have carried out the switchpoint adjustment, turn the function switch to position 1 to return to operation.

6.2.8 Configuring two-point control and buildup mode

Function switch setting	Function	- key	+ key	Light emitting diodes (LED signals)					
									
 A		 B	 C	 1 (green)	 2 (green)	 3 (red)	 4 (green)	 5 (green)	 6 (yellow)
4 	Two-point control Δs		Press once					On	
	buildup mode		Press twice				On	On	**

* These settings are factory settings.

** Switch status signaling (on/off/flashing) depends on the mounting location selected and the fail-safe mode (MIN/MAX) set. The LED flashes if a calibration has not yet been carried out.



Note!

















- If the bulk solids are nonconductive, probes installed vertically can also be used for two-point control. The switchpoints of the empty **and** full calibration activate, for example, a handling device. If you want to use the two-point control, please note the following:
 - Set the necessary measuring range. For more information, see Page 51, "Setting the measuring range."
 - Perform empty and full calibration.
 - Set the fail-safe mode (MIN/MAX) in accordance with your requirements. For more information, see Page 60.
- If you switch on the two-point control (Δs mode), the switchpoint adjustment (as described on Page 56) is disabled. The switch points correspond to the calibration points.
- The "Buildup mode" ensures that a safe switch point is output even if the probe is not fully released from the conductive medium ($> 1000 \mu\text{S}/\text{cm}$ e.g. plaster). Deposits or buildup on the sword/rope are compensated for.

To configure the two-point control and/or buildup mode, proceed as follows:

1. Turn the function switch to position 4.
2. Press the "+" key for at least two seconds to switch on the **two-point control**. The green LED 5 lights up.
3. Press the "+" key again for at least two seconds to switch on **buildup mode**. Green LEDs 4 and 5 light up.
 - Pressing the "+" again for at least two seconds switches off both functions. Green LEDs 4 and 5 are off.
4. After you have configured the desired setting, turn the function switch to position 1 to return to operation.

You have now completed the settings for the two-point control and buildup mode.

6.2.9 Setting the switching delay

Function switch setting	Function	- key	+ key	Light emitting diodes (LED signals)					
									
 A		 B	 C	 1 (green)	 2 (green)	 3 (red)	 4 (green)	 5 (green)	 6 (yellow)
5 	Switching delay	Press for <	Press for >	Off (0.3 s)	On * (1.5 s)	Off (5 s)	Off (10 s)		**

* These settings are factory settings.

** Switch status signaling (on/off/flashing) depends on the mounting location selected and the fail-safe mode (MIN/MAX) set. The LED flashes if a calibration has not yet been carried out.



Note!

- The switching delay causes the device to signal the level limit after a delay. This is particularly useful in tanks with turbulent medium surfaces caused, for example, by the filling process or by collapsing mounds. By doing so, you ensure that the filling of the tank does not end until the probe is continuously covered by the medium.
- A switching delay that is too short may, for example, cause the filling process to be restarted as soon as the medium surface settles.



Caution!

If too long of a switching delay is set, this can cause the tank to overflow.

To set the switching delay, proceed as follows:

1. Turn the function switch to position 5.
2. Press the "+" key for at least two seconds to select the next higher value. Hold the "+" or "-" keys down to skip from one value to another. The possible values are signaled by the LEDs 1 to 4.
3. Set the desired value.

You have now set the switching delay and can turn the function switch back to position 1 (operation).

6.2.10 Activating the self-test (function test)



Caution!
 Make sure that you do not accidentally activate any processes with the self-test!
 This could result, for example, in overflowing of the tank.

Function switch setting	Function	- key	+ key	Light emitting diodes (LED signals)					
				⏻		⏻			⚙️
 A		 B	 C	 1 (green)	 2 (green)	 3 (red)	 4 (green)	 5 (green)	 6 (yellow)
6	Self-test (function test)	Press both keys		Off * (inactive)				Flashes (active)	**

* These settings are factory settings.

** Switch status signaling (on/off/flashing) depends on the mounting location selected and the fail-safe mode (MIN/MAX) set.
 The LED flashes if a calibration has not yet been carried out.



Note!
 The self-test simulates switching states (probe not covered, probe covered).
 This allows you to check if the connected devices are activated correctly.

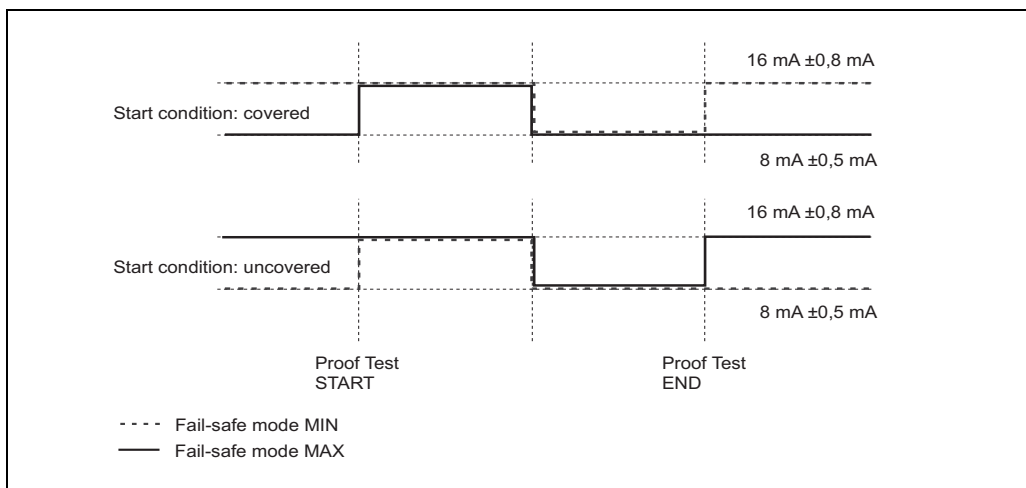

To carry out a self-test, proceed as follows:

1. Turn the function switch to position 6.
2. Press the "+" and "-" keys simultaneously for at least two seconds.
 The self-test is active when the green LED 5 flashes.
 The green operational LED 1 is off.
3. After approx. 20 seconds, the test is completed. This is indicated by the lighting up of the operational LED 1.

You have now carried out the self-test and can turn the function switch back to position 1 (operation).

6.2.11 Setting SIL and the MIN/MAX fail-safe mode



Note!

The SIL mode function is only available in conjunction with the electronic insert FEI55.

Function switch setting	Function	- key	+ key	Light emitting diodes (LED signals)					
				1 (green)	2 (green)	3 (red)	4 (green)	5 (green)	6 (yellow)
1	Operation			Flashes Operational LED	On*** (MIN-SIL)	Flashes (warning/ alarm)	On*** (MAX-SIL)		On/off/ flashes**
7	MIN-/MAX Fail-safe mode	Press for MIN	Press for MAX	Off (MIN)				On * (MAX)	**
	Lock/unlock SIL mode***	Press both keys			On (MIN-SIL)		On (MAX-SIL)		

* These settings are factory settings.

** Switch status signaling (on/off/flashing) depends on the mounting location selected and the fail-safe mode (MIN/MAX) set. The LED flashes if a calibration has not yet been carried out.

*** Only in conjunction with electronic insert FEI55 (SIL). The device is in the SIL mode. To change the current settings, the device must be unlocked.



Note!

By selecting the fail-safe mode correctly, you ensure that the output always operates safely with quiescent current.

- **Minimum failsafe mode (MIN):** The output switches if the switchpoint is undershot (sword/rope uncovered), a fault occurs or the line voltage fails.
- **Maximum failsafe mode (MAX):** The output switches if the switchpoint is exceeded (sword/rope covered), a fault occurs or the line voltage fails.

To set the MIN or MAX fail-safe mode, proceed as follows:

1. Turn the function switch to position 7.
2. Fail-safe mode
 - Press the "-" key for at least two seconds to set the MIN failsafe mode. The green LED 1 starts to light up.
 - Press the "+" key for at least two seconds to set the MAX failsafe mode. The green LED 5 starts to light up.

You have now set the fail-safe mode and can turn the function switch back to position 1 to resume operation.

Locking SIL mode (only with electronic insert FEI55)

With the "SIL mode", you can safeguard the device settings against being changed unintentionally. The device settings can only be changed once the "SIL mode" has been unlocked.

- Turn the function switch to position 7 "locking/unlocking SIL mode".
- Check the selected MIN or MAX failsafe mode.
- Proceed as follows to lock the selected failsafe mode:
 - Press the "-" and "+" keys together for approx. 4 seconds and
 - release the keys when the red LED (fault) starts to flash.



Note!

















Locking in "Lock SIL mode" activates the fault message at the current output ($I < 3.6 \text{ mA}$). This is signaled by the illuminated red LED 3.

- Active locking is indicated as follows:
 - In the case of "MIN-SIL", active locking is indicated by the illuminated green LED 2. The illuminated LED 1 goes out.
 - In the case of "MAX-SIL", active locking is indicated by the illuminated green LED 4. The illuminated LED 5 goes out.
- The set SIL mode is activated by setting the function switch to position 1 "Operation". The red LED 3 goes out and the green LED 1 starts to flash.
The device is operational.

Unlocking SIL mode (only with electronic insert FEI55)

- Turn the function switch to position 7 "locking/unlocking SIL mode".
- To unlock the device, proceed as follows:
 - Press the "-" and "+" keys together for approx. 4 seconds and
 - release the keys again when the "MIN-SIL" or "MAX-SIL" LED goes out.
- Turn the function switch to position 1 "Operation" to operate the device without the SIL mode.

6.2.12 Upload/download Sensor DAT (EEPROM)

Function switch setting	Function	- key	+ key	Light emitting diodes (LED signals)					
									
 A		 B	 C	 1 (green)	 2 (green)	 3 (red)	 4 (green)	 5 (green)	 6 (yellow)
8 	Upload/download Sensor DAT (EEPROM)	Press for download	Press for upload	Flashes (download)				Flashes (upload)	**

* These settings are factory settings.

** Switch status signaling (on/off/flashing) depends on the mounting location selected and the fail-safe mode (MIN/MAX) set. The LED flashes if a calibration has not yet been carried out.

*** Only in conjunction with electronic insert FEI55 (SIL). The device is in the SIL mode. To change the current settings, the device must be unlocked.



Note!















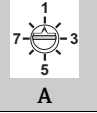

- The customer-specific settings of the electronic insert (e.g. empty/full calibration, switchpoint adjustment) are stored automatically in the Sensor DAT (EEPROM) and in the electronic insert.
- The Sensor DAT (EEPROM) is updated automatically each time a parameter is changed in the electronic insert.
- When replacing the electronic insert, all the Sensor DAT (EEPROM) data are transferred to the electronic insert by means of a manual upload. No additional settings are required.
- If, for example, you need to transfer the customer-specific settings of an electronic insert to multiple sensor DATs (EEPROMs), you must carry out a manual download after installing the electronic insert.
 - **Upload:** An upload transfers the saved data from the Sensor DAT (EEPROM) to the electronic insert. The electronic insert does not have to be configured any more, and the device is then operational.
 - **Download:** A download transfers the saved data from the electronic insert to the Sensor DAT (EEPROM).

To carry out a sensor upload/download, proceed as follows:

1. Turn the function switch to position 8.
2. Press the "-" key for at least two seconds to carry out a download (the data from the electronic insert are transferred to the Sensor DAT (EEPROM)). During the download, the green LED 1 flashes.
3. Press the "+" for at least two seconds to carry out an upload (the data from the Sensor DAT (EEPROM) are transferred to the electronic insert). The green LED 5 flashes during upload.

You have now transmitted the data and can turn the function switch back to position 1 (operation).

6.2.13 Restoring factory settings

Function switch setting	Function	- key	+ key	Light emitting diodes (LED signals)					
									
 A		 B	 C	 1 (green)	 2 (green)	 3 (red)	 4 (green)	 5 (green)	 6 (yellow)
1 	Operation			Flashes Operational LED	On*** (MIN-SIL)	Flashes (warning/ alarm)	On*** (MAX-SIL)		On/off/ flashes**
	Restore factory setting	Press both keys for approx. 20 s		On	->	->	->	->	**

* These settings are factory settings.

** Switch status signaling (on/off/flashing) depends on the mounting location selected and the fail-safe mode (MIN/MAX) set.
The LED flashes if a calibration has not yet been carried out.

*** Only in conjunction with electronic insert FEI55 (SIL). The device is in the SIL mode. To change the current settings, the device must be unlocked.



Note!

- This function allows you to restore the factory settings. This is particularly useful if the device has already been calibrated once and, for example, there is a fundamental change in the medium in the tank.
- After restoring the factory settings, you must repeat the calibration.

To restore the factory settings, proceed as follows:

1. Turn the function switch to position 1.
2. Press the "+" and "-" keys simultaneously for approx. 20 seconds. During the time it takes to restore the factory settings, the LEDs 1–5 light up consecutively.
3. The factory settings have been successfully restored if the green LED 1 and the yellow LED are flashing.

You have now restored the factory settings and can continue with setting the measuring range and the calibration.

6.2.14 Output signals

Output signal FEI51

Safety mode	Level	Output signal	LEDs					
			gn	gn	rd	gn	gn	ye
MAX		L^+ 1 $\xrightarrow{I_L}$ 3						
		1 $\xrightarrow{< 3,8 \text{ mA}}$ 3						
MIN		L^+ 1 $\xrightarrow{I_L}$ 3						
		1 $\xrightarrow{< 3,8 \text{ mA}}$ 3						
Maintenance required		$I_L / < 3,8 \text{ mA}$ 1 $\xrightarrow{\quad}$ 3						
Instrument failure		1 $\xrightarrow{< 3,8 \text{ mA}}$ 3						

BA300Fen017

* See → 76, "Troubleshooting"

Output signal FEI52

Safety mode	Level	Output signal	LEDs					
			gn	gn	rd	gn	gn	ye
MAX		L^+ 1 $\xrightarrow{I_L}$ 3						
		1 $\xrightarrow{I_R}$ 3						
MIN		L^+ 1 $\xrightarrow{I_L}$ 3						
		1 $\xrightarrow{I_R}$ 3						
Maintenance required		1 $\xrightarrow{I_L / I_R}$ 3						
Instrument failure		1 $\xrightarrow{I_R}$ 3						

Tt418Fen43

* See → 76, "Troubleshooting"

Output signal FEI54

Safety mode	Level	Output signal	LEDs					
			gn	gn	rd	gn	gn	ye
MAX		 3 4 5 6 7 8						
		 3 4 5 6 7 8						
MIN		 3 4 5 6 7 8						
		 3 4 5 6 7 8						
Maintenance required								
Instrument failure		 3 4 5 6 7 8						

* See → 76, "Troubleshooting"

T1418Fen48

Output signal FEI55

Safety mode	Level	Output signal	LEDs					
			gn	gn	rd	gn	gn	ye
MAX		+ ~16 mA → 1						
		+ ~8 mA → 1						
MIN		+ ~16 mA → 1						
		+ ~8 mA → 1						
Maintenance required *		+ 8/16 mA → 1						
Instrument failure		+ < 3.6 mA → 1						

* See → 76, "Troubleshooting"

T1418Fen51

6.3 Commissioning with electronic inserts FEI53 or FEI57S

This section describes how to commission the device with electronic insert versions FEI53 and FEI57S.



Note!

The measuring system is not operational until you have carried out a calibration at the switching unit.

For information on how to carry out the calibration, refer to the documentation for the Nivotester switching device FTCxxx.

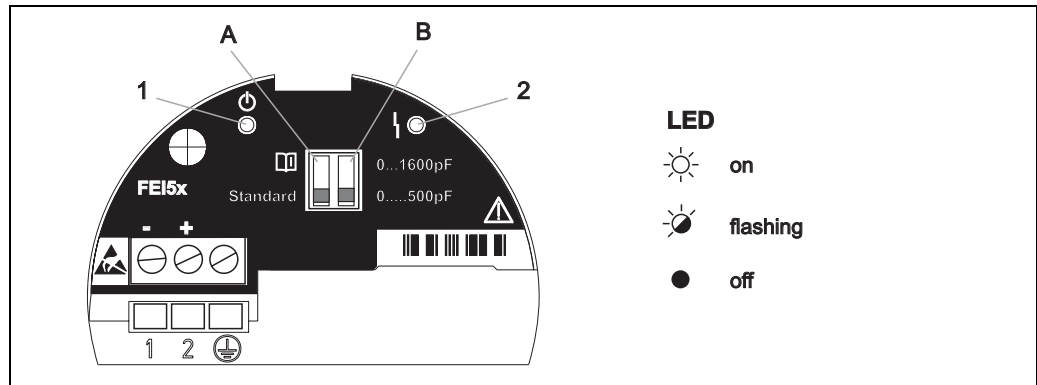

LED 1 operational ⏻: Flashes at 5-second intervals.

LED 2 fault ⚠: The red LED flashes if there is a fault that you can correct.

LED 2 fault ⚠: The red LED lights up continuously if the device has a fault that cannot be corrected. See also → 76, "Troubleshooting".

6.3.1 Setting the alarm response if the measuring range is exceeded



DIP switch	Function
A Standard	Standard: If the measuring range is exceeded no alarm is output (factory setting).
A	: If the measuring range is exceeded an alarm is output.



Note!

- With this setting, you can determine the alarm response of the measuring system If the measuring range is exceeded. You can switch the alarm on or off If the measuring range is exceeded.
- All other settings with regard to the alarm response have to be configured on the respective Nivotester switching device.

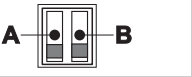
6.3.2 Setting the measuring range

DIP switch		Function
		
B	 0...500pF	Measuring range: The measuring range is between 0 to 500 pF (factory setting). Span: The span is between 5 to 500 pF.
B	 0...1600pF	Measuring range: The measuring range is between 0 to 1600 pF. Span: The span is between 5 to 1600 pF.











Note!

- The choice of measuring range (0 to 500 pF and 0 to 1600 pF) depends on the function of the probe. If the probe is used as a limit switch, you can retain the factory setting of 0 to 500 pF.
- If the probe is used for two-point control, the following recommendations apply for vertical installation:
 - Measuring range from 0 to 500 pF for probe lengths up to 1.0 m
 - Measuring range from 0 to 1600 pF for probe lengths up to 4.0 m

All other settings must be made on the respective Nivotester switching device.

6.3.3 Output signals

Output signal FEI53

Mode	Output signal	LEDs	
		green	red
Normal operation	3...12 V at terminal 3		
Maintenance required * 	3...12 V at terminal 3		
Instrument failure 	< 2,7 V at terminal 3		

* See →  76, "Troubleshooting"

TI418Fen46

Output signal FEI57S

Mode	Output signal	LEDs	
		green	red
Normal operation	60...185 Hz 1 -----> 2		
Maintenance required * 	60...185 Hz 1 -----> 2		
Instrument failure 	< 20 Hz 1 -----> 2		

TI18Fen54

* See → 76 ff., "Troubleshooting"

6.4 Commissioning with the electronic insert FEI58

This chapter describes the process for commissioning the device with electronic insert FEI58.



Note!

- The measuring system is not operational until you have carried out a calibration.
- Additional functions associated with the switching unit are described in the documentation for the switching unit, e.g. Nivotester FTL325N, FTL375N (for devices from Endress+Hauser).

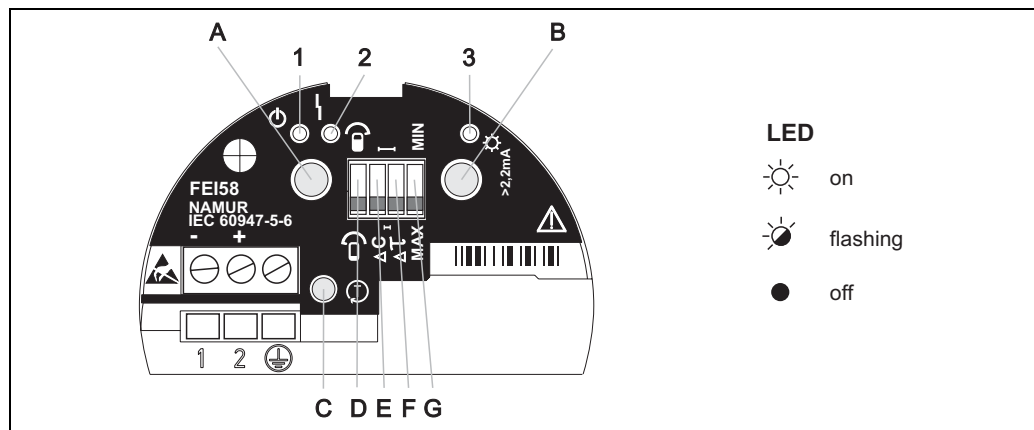

BA299Fen016

Green LED 1 (Ⓞ operational), red LED 2 (⚡ fault), yellow LED 3 (⚡ switching state)

6.4.1 Keys (A, B, C) on FEI58

- To prevent unintentional operation of the device, approx. 2 seconds (s) have to elapse before the system evaluates and executes a function commanded when a key is pressed (keys A and B). Test key C disconnects the power supply immediately.
- Both keys have to be pressed simultaneously to trigger switch point adjustment.

Key	Function		
A	B	C	
X			Display diagnostic code
	X		Display calibration situation
X	X		Perform calibration (during operation)
X	X		Delete calibration points (during startup)
		X	Test key Ⓞ, (disconnects the transmitter from the switching unit)

6.4.2 Performing calibration



Note!

- An empty and full calibration provides the greatest possible operational security. This is particularly recommended for critical applications.
- The empty and full calibration measures the capacitance values of the probes when the tank is full and when it is empty. If, for example, the measured capacitance value of the empty calibration is 50 pF and that of the full calibration is 100 pF, the average capacitance value, 75 pF, is stored as the switchpoint.

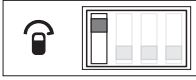
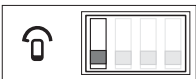
DIP switch: C		Function
D		The probe is covered during calibration.
D		The probe is uncovered during calibration.

Carrying out empty calibration

To carry out an empty calibration, proceed as follows:

1. Check to make sure that the probe is not covered with product.
2. Before calibrating, select the "uncovered" probe state on DIP switch D.
3. Press keys **A** and **B** simultaneously for at least 2 s to save the calibration value.
4. The green LED 1 flashes quickly to indicate that the value has been saved correctly.

The process of saving the empty calibration value is finished once green LED 1 flashes slowly again.

Carrying out the full calibration

To carry out a full calibration, proceed as follows:



1. Make sure that the probe is covered by the medium up to the desired switchpoint.
2. Before calibrating, select the "covered" probe state on DIP switch D.
3. Press keys **A** and **B** simultaneously for at least 2 s to save the calibration value.
4. The green LED 1 flashes quickly to indicate that the value has been saved correctly.

The process of saving the empty calibration value is finished once green LED 1 flashes slowly again.

6.4.3 Setting the switchpoint adjustment

Note the following when selecting switch point adjustment:

- If only one calibration (empty or full) was carried out, and if buildup forms on the rod probe while the probe is in operation, the device may no longer respond to changes in level. A switch point adjustment compensates for this condition and ensures that you obtain a constant switch point again.
- For media that do not have a tendency to build up, we recommend a setting of 2 pF, as the probe is most sensitive to changes in level at this setting.
- For media with heavy buildup (e.g. plaster), we recommend using probes with active buildup compensation and using the setting 10 pF.

DIP switch: D		Function
E		Switchpoint adjustment: 10 pF (for media with heavy buildup, e.g. sewage sludge)
E		Switchpoint adjustment: 2 pF (for media that do not cause buildup e.g. water)

6.4.4 Setting the switching delay



Note!

- The switching delay causes the device to signal the level limit after a delay. This is particularly useful in tanks with turbulent medium surfaces caused, for example, by the filling process or by collapsing mounds. By doing so, you ensure that the filling of the tank does not end until the probe is continuously covered by the medium.
- A switching delay that is too short may, for example, cause the filling process to be restarted as soon as the medium surface settles.



Caution!

If too long of a switching delay is set, this can cause the tank to overflow.

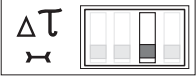
DIP switch: E		Function
F		Switching delay: 5 s
F		Switching delay: 1 s



6.4.5 MIN/MAX fail-safe mode



Note!

By selecting the failsafe mode correctly, you ensure that the output always operates safely with quiescent current.

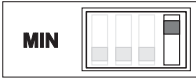
- Minimum failsafe mode (MIN): The output switches if the switchpoint is undershot (rod/rope uncovered), a fault occurs or the line voltage fails.
- Maximum failsafe mode (MAX): The output switches if the switchpoint is exceeded (rod/rope covered), a fault occurs or the line voltage fails.

DIP switch: F		Function
G		Fail-safe mode: MIN The output switches safety-oriented when the probe is uncovered (signal on alarm). For use for dry running protection and pump protection for example
G		Fail-safe mode: MAX The output switches safety-oriented when the probe is covered (signal on alarm). For use with overflow protection for example

6.4.6 Display calibration situation

You can use this function to see what calibrations have been performed on the device. The calibration situation is indicated by the three LEDs.

To query the calibration situation, proceed as follows:

1. Press the **B** key for at least 2 s.
2. The current calibration situation is indicated by the LEDs (operating/switching status).

Light emitting diodes (LED signals)			Calibration situation
Green LED 1 ⏻ Operational	Red LED 2 ⚠ Fault	Yellow LED 3 ⚙ Switching status	
			No calibration
On			Empty calibration performed
		On	Full calibration performed
On		On	Empty and full calibration performed

6.4.7 Displaying the diagnostic code

This function makes it possible to interpret faults using the three LEDs. If the system detects more than one fault, the fault with the highest priority is shown on the display.

Further information is provided in the "Fault diagnostics" section → [77](#).

6.4.8 Test key C (open circuit)



Caution!

This test can be used to activate safety-specific measures in the plant (e.g. alarms)!

Pressing test key C disconnects the supply voltage.

If the power supply is disconnected, a supply unit such as Nivotester FTL325N from Endress+Hauser reacts in such a way that the alarm relay outputs an error and appropriate responses are triggered in any slave devices connected.

To perform the function test, proceed as follows:

1. Press test key C for the entire duration of the test.
The power supply from the supply unit is disconnected immediately.
2. All the LEDs go out. The safety functions (e.g. error message alarm) configured for the supply unit are activated.
3. Release test key C again to end the function test.

6.4.9 Output signals

Output signal FEI58

Safety mode	Level	Output signal	LEDs		
			gn	rd	ye
MAX		+ 2.2 ... 2 3.5 mA → 1			
		+ 0.6 ... 2 1.0 mA → 1			
MIN		+ 2.2 ... 2 3.5 mA → 1			
		+ 2 → 1			
Maintenance required *		+ 0.6 ... 1.0 mA 2 2.2 ... 3.5 mA → 1			
Instrument failure		+ 0.6 ... 2 1.0 mA → 1			

* See also → 76 ff., "Troubleshooting"

T1418Fen54

7 Maintenance

No special maintenance work is required for the Solicap S point level switch.

Exterior cleaning

When cleaning the exterior of the Solicap S, make sure that the cleaning agent used does not corrode the housing surface or the seals.

Repair

In accordance with the Endress+Hauser repair principle, the devices have a modular design and repairs can be carried out by the customer.

Spare parts are grouped logically into kits along with the respective replacement instructions. On Page →  78 you will find a list of all spare parts kits, together with their order numbers, that can be ordered from Endress+Hauser and used to repair the Solicap S. For more information about service and spare parts, contact Endress+Hauser Service.

Repairing Ex-certified devices

The following information also has to be taken into account for repairs of Ex-certified devices:

- Ex-certified devices may be repaired only by experienced, skilled staff or by Endress+Hauser Service.
- Applicable standards, federal/national Ex standards and the Safety Instructions (XA) and certificates must be observed.
- Only genuine spare parts from Endress+Hauser may be used.
- When ordering spare parts, please note the device designation on the nameplate. Parts can only be replaced by the same parts.
- Repairs must be carried out according to the instructions. Following the repair, the individual testing specified for the device must be carried out.
- Certified devices can only be converted into other certified devices by Endress+Hauser Service.
- Every conversion and repair made to the device must be documented.

Replacement

After replacing a Solicap S unit or the electronic insert, the calibration values must be transmitted to the replacement unit.

- If a probe is replaced, the calibration values are transferred to the Sensor DAT (EEPROM) by means of a manual download in the electronic insert.
- If the electronic insert is replaced, the calibration values are transferred to the electronics by means of a manual upload in the Sensor DAT (EEPROM).

This means that you can restart the device without having to carry out a new calibration (see also →  62).

8 Accessories

8.1 Weather protection cover

For F13 and F17 housing
Order number: 71040497

8.2 Overvoltage protection HAW56x

8.2.1 Overvoltage protection (housing)

- HAW569–A11A (non-hazardous)
- HAW569–B11A (hazardous area)



Note!

These two versions can be screwed directly into the housing (M20x1.5).

Surge arrester for limiting overvoltage in signal lines and components.

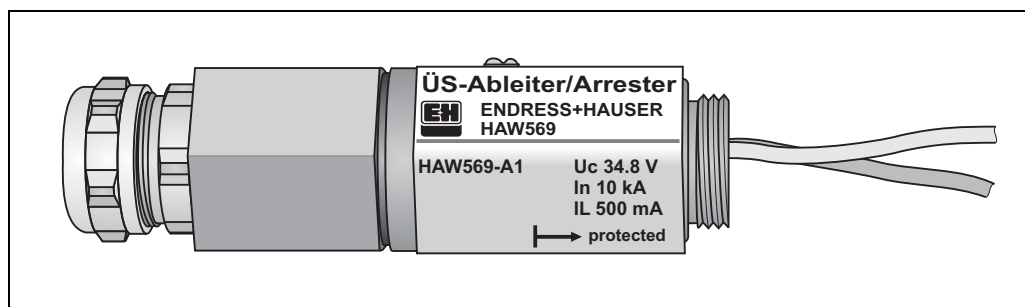

L00-FM15xxxx-03-05-xx-xx-009

8.2.2 Overvoltage protection (cabinet)

- HAW562Z (hazardous area)

The HAW562Z module can be used for installation in cabinets.

8.3 Adapter flange FAU70E / FAU70A

The following (steel) probe versions are available for fine-grained bulk solids:

- R 1½
- NPT 1½

Adapter flanges that can be ordered via the following FAU70E and FAU70A product structures are optionally available.

- **FAU70E**

- 1233 -> DN50 PN16 A, flange EN1092-1 (DIN2527 B)
- 1433 -> DN80 PN16 A, flange EN1092-1 (DIN2527 B)
- 1533 -> DN100 PN16 A, flange EN1092-1 (DIN2527 B)

- **FAU70A**

- 2253 -> 2" 150lbs FF, flange ANSI B16.5
- 2453 -> 3" 150lbs FF, flange ANSI B16.5
- 2553 -> 4" 150lbs FF, flange ANSI B16.5

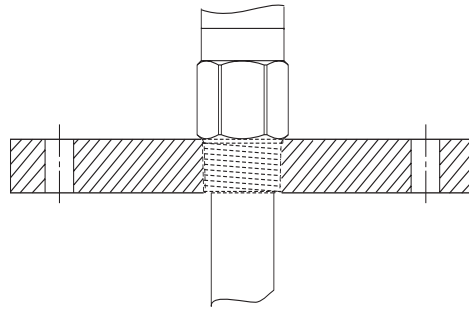

BA381 Fxx025

9 Troubleshooting

9.1 Fault diagnostics in the electronic insert



Note!

In the event of faults during commissioning or operation of the device, you have the ability to carry out fault diagnostics on the electronic insert. This function is supported by the electronic inserts FEI51, FEI52, FEI54, FEI55 (see error table 1 and 2 below).

The electronic inserts FEI53, FEI57S and FEI58 signal two types of faults:

- Correctable faults: The red LED flashes.
- Non-correctable faults: The red LED is lit continuously.

For additional information on fault detection and fault elimination, refer to fault table 2 below.

9.1.1 Activating fault diagnostics FEI51, FEI52, FEI54, FEI55



Note!

The diagnostics provide information about the operating status of the device. The results of the diagnostics are displayed by LEDs 1, 2, 4 and 5. If the diagnostics detect multiple faults, these are shown according to their priority. A serious fault (e.g. priority 3) is always displayed before a less serious fault (e.g. priority 5).

To activate the fault diagnostics, proceed as follows:

1. Set the function switch to position 1 (operation).
2. Press the "-" key.
3. "Fault table 1" lists possible causes of faults and information on how to eliminate them.

LEDs for diagnostics						Error table 1 (FEI51, FEI52, FEI54, FEI55) Cause	Remedy	Priority
1 (green)	2 (green)	3 (red)	4 (green)	5 (green)	6 (yellow)			
						No fault		
On						Internal fault	Replace electronics.	1
	On				On	Calibration point(s) are outside the measuring range	Recalibrate	2
On				On		Calibration points swapped	Recalibrate	3
	On					The calibration point is too close to the measuring range limit.	Reduce the switchpoint or select a new mounting location.	4
On	On					No calibration has yet been carried out.	Carry out empty and/or full calibration.	5
			On			The DC PNP output is overloaded.*	Reduce the connected load.	6
On			On			The capacitance change from probe "covered" to probe "not covered" is too small.	Contact Endress+Hauser Service.	7
	On		On			Sensor DAT (EEPROM) data are invalid.	Carry out download from the electronic insert.	8
On	On		On			Probe is not detected **.	The probe type is not compatible. Use a Solicap S probe.	9
				On		The measured temperature is outside the permitted temperature range.	Operate the device only in the specified temperature range.	10

* Applies only to electronic insert FEI52.

** A connection to the Sensor DAT (EEPROM) could not be established.

9.1.2 Activating fault diagnostics: FEI53, FEI57S

Cause	Remedy
The device does not switch.	Check the connection and the supply voltage.
Alarm LED flashes.	The ambient temperature of the electronics is outside the permitted range or the connection to the probe is interrupted.

9.1.3 Activating fault diagnostics FEI58

Displaying the diagnostic code

This function makes it possible to interpret faults using the three LEDs. If the system has detected more than one fault, the fault with the highest priority is shown on the display.

To display the diagnostic code, proceed as follows:

1. Press the B key for at least 2 s.
2. The current diagnostics code is indicated by the LEDs (operating/fault/switching status).

No.	1 green operational	2 red fault	3 yellow switching status	Cause	Remedy	Priority
0				No fault	---	---
1	On			Internal fault	The device is defective	1
2		On		The calibration point is too close to the measuring range limit	Reduce the switchpoint or select a new mounting location	2
3			On	Calibration points have been accidentally interchanged	Perform uncovered calibration with the probe uncovered, and covered calibration with the probe covered	3
4	On	On		No calibration has yet been carried out.	Carry out empty and/or full calibration	4
5	On		On	The change in capacitance from uncovered probe to covered probe is too small	The capacitance change between the uncovered and covered probe must be greater than 2 pF	5
6		On	On	Probe not detected	Connect the probe	6
7	On	On	On	The measured temperature is outside the permitted range	The device may be operated in the specified temperature range only	7

9.2 Spare parts



Note!

- You can order spare parts directly from your E+H service organization by quoting the order number (see below).
- The corresponding spare part number is on every spare part. Installation instructions can be found in the form supplied with the spare parts.
- Before ordering, please note that all ordered spare parts must correspond with the indications on your nameplate. Otherwise, the indications on the nameplate will no longer correspond with the instrument version.

9.2.1 Electronic inserts

Electronic insert	Parts number
FEI51	71042887
FEI52	71025819
FEI53	71025820
FEI54	71025814
FEI55	71025815
FEI57S	71025816
FEI58	71100895

9.2.2 Housing cover

Cover	Parts number
For aluminum housing F13: gray with sealing ring	52002698
For stainless steel housing F15: with sealing ring	52027000
For stainless steel housing F15: with clasp and sealing ring	52028268
For polyester housing F16, flat: gray with sealing ring	52025606
For aluminum housing F13, flat: gray with sealing ring	52002699
For aluminum housing T13, flat: gray with sealing ring/electronics compartment	52006903
For aluminum housing T13, flat: gray with sealing ring/connection compartment	52007103

Seal set for stainless steel housing

- Seal set for stainless steel housing F15 with 5 sealing rings: part number 52028179

9.2.3 Cable for separate housing

- Cable for separate housing F15, F16 and F17 in conjunction with Solicap 71084478

9.3 Return

You must take the following measures before returning a measuring device to Endress+Hauser, for example for repair:

- Remove all traces of the medium. Pay particular attention to crevices and grooves for seals into which the medium can penetrate. This is particularly important if the medium is hazardous to health, e.g. combustible, toxic, caustic, carcinogenic etc.
- Always enclose a fully completed "Declaration of Contamination" form with the device (a master copy of the "Declaration of Contamination" form can be found at the end of these Operating Instructions). Only then can Endress+Hauser check or repair a returned device.
- If necessary, enclose special handling instructions when returning the device, e.g. a safety data sheet in accordance with EN 91/155/EEC.

In addition, specify the following:

- The chemical and physical properties of the medium
- A description of the application
- A description of the fault that occurred
- Operating time of the device

9.4 Disposal

At disposal, ensure that materials are properly separated and the device components are reused.

9.5 Firmware history

Electronics	Release date	Software version	Software change
FEI51	10/2007	V 01.00.XX	Original software
FEI52	07/2006	V 01.00.XX	Original software
FEI53	07/2006	V 01.00.XX	Original software
FEI54	07/2006	V 01.00.XX	Original software
FEI55	11/2008	V 02.00.XX	Extended for SIL functionality
FEI57s	07/2006	V 01.00.XX	Original software
FEI58	01/2010	V 01.00.XX	Original software

9.6 Contact addresses at Endress+Hauser

On the back page of these Operating Instructions, you can find an internet address for Endress+Hauser. The web site provides contact addresses that you can use in case of any questions.

10 Technical data

10.1 Input

10.1.1 Measured variable

Level limit detection of change in capacitance between probe rod and container wall or ground tube, depending on the level of a liquid.

10.1.2 Measuring range (valid for all FEI5x)

- Measuring frequency:
500 kHz
- Span:
 $\Delta C = 5$ to 1600 pF
 $\Delta C = 5$ to 500 pF (with FEI58)
- Final capacitance:
 $C_E = \text{max. } 1600$ pF
- Adjustable initial capacitance:
 $C_A = 5$ to 500 pF (range 1 = factory setting)
 $C_A = 5$ to 1600 pF (range 2; not with FEI58)

10.1.3 Input signal

Probe covered => high capacitance
Probe not covered => low capacitance

10.2 Output

10.2.1 Galvanic isolation

FEI51, FEI52

between rod probe and power supply

FEI54

between rod probe, power supply and load

FEI53, FEI55, FEI57S, FEI58

see connected switching device (functional galvanic isolation in the electronic insert)

10.2.2 Switch behavior

Binary or Δs mode (controlling a screw conveyor, not with FEI58)

10.2.3 Switch-on behavior

When the power supply is switched on, the switching status of the outputs corresponds to the signal on alarm. The correct switch condition is reached after max. 3 seconds.

10.2.4 Fail-safe mode

Minimum/maximum quiescent current safety can be switched at the electronic insert (for FEI53 and FEI57S only at Nivotester FTCxxx)

MAX = minimum safety: The output switches safety-oriented when the probe is uncovered (signal on alarm). For use for dry running protection and pump protection for example

MAX = maximum safety: The output switches safety-oriented when the probe is covered (signal on alarm). For use with overflow protection for example

10.2.5 Switching delay

FEI51, FEI52, FEI54, FEI55

Can be adjusted incrementally at the electronic insert: 0.3 to 10 s

FEI53, FEI57S

Depends on the connected Nivotester (transmitter): FTC325, FTC625, FTC470Z or FTC471Z

FEI58

Can be adjusted alternately at the electronic insert: 1 s/5 s

10.3 Performance characteristics

10.3.1 Reference operating conditions

- Room temperature: +20 °C ±5 °C
- Span:
 - Standard measuring range: 5 to 500 pF
 - Extended measuring range: 5 to 1600 pF
 - Span for reference: 5 to 250 pF
- Uncertainty according to DIN 61298-2: max ±0.3%
- Non-repeatability (reproducibility) according to DIN 61298-2: max. ±0.1 %

10.3.2 Switch point

- Uncertainty according to DIN 61298-2: max ±0.3%
- Non-repeatability (reproducibility) according to DIN 61298-2: max. ±0.1 %

10.3.3 Ambient temperature effect

Electronic insert



< 0.06 % / 10 K related to the full scale value

Separate housing

Capacitance change of connecting cable per meter 0.15 pF/10K

10.4 Operating conditions: Environment

10.4.1 Ambient temperature range

- Ambient temperature of the transmitter (note derating, see →  83):
 - –50 to +70 °C
 - –40 to +70 °C (with F16 housing)
- A weather protection cover should be used when operating outdoors in strong sunlight. For further information on the weather protection cover, see →  74.

10.4.2 Storage temperature

–50 °C to +85 °C

10.4.3 Climate class

DIN EN 60068-2-38/IEC 68-2-38: test Z/AD

10.4.4 Degree of protection

	IP66*	IP67*	IP68*	NEMA4X**
Polyester housing F16	X	X	-	X
Stainless steel housing F15	X	X	-	X
Aluminum housing F17	X	X	-	X
Aluminum housing F13 with gas-tight process seal	X	-	X***	X
Aluminum housing T13 with gas-tight process seal and separate connection compartment (EEx d)	X	-	X***	X
Separate housing	X	-	X***	X

* As per EN60529

** As per NEMA 250

*** Only with M20 cable entry or G1/2 thread

10.4.5 Vibration resistance

DIN EN 60068-2-64/IEC 68-2-64: 20 Hz– 2000 Hz; 0.01 g²/Hz

10.4.6 Cleaning

Housing

When cleaning, make sure that the cleaning agent used does not corrode the housing surface or the seals.

Probe

Depending on the application, buildup (contamination and soiling) can form on the probe rod. A high degree of material buildup can affect the measurement result. If the medium tends to create a high degree of buildup, regular cleaning is recommended. When cleaning, it is important to make sure that the insulation of the probe rod is not damaged. If cleaning agents are used make sure the material is resistant to them!

10.4.7 Electromagnetic compatibility (EMC)

- Interference emission to EN 61326, Electrical Equipment Class B
Interference immunity in accordance with EN 61326, Appendix A (Industrial) and NAMUR Recommendation NE 21 (EMC)
- A usual commercial instrument cable can be used.

10.4.8 Shock resistance

DIN EN 60068-2-27/IEC 68-2-27: 30g acceleration

10.5 Operating conditions: Process

10.5.1 Process temperature range



Note!

- The following process temperature ranges only apply for standard applications outside hazardous areas.
- Regulations for use in hazardous areas are provided in the Supplementary Documentation XA389F/00.

Permitted ambient temperature T_a at the housing depending on the process temperature T_p in the tank.

Compact version

Sword and rope version

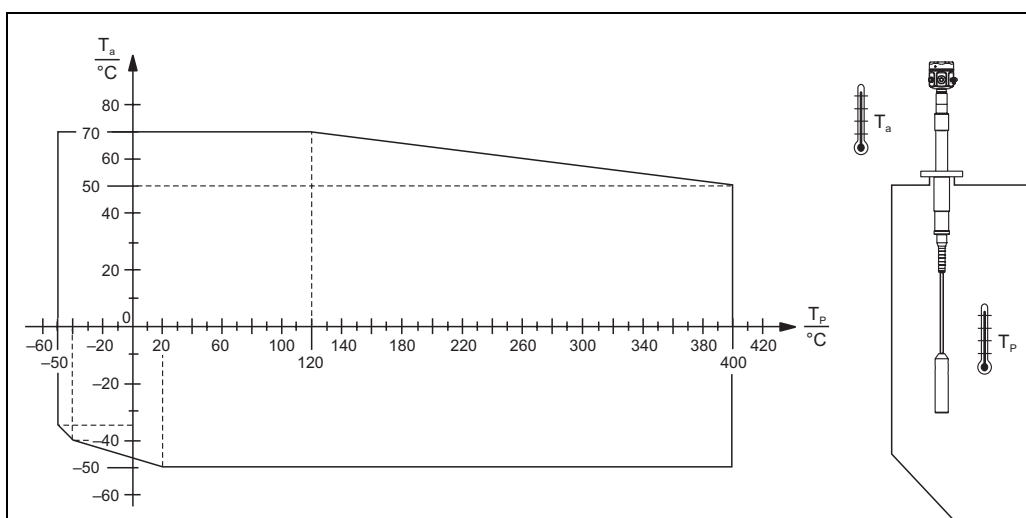

T_a = ambient temperature,

T_p = process temperature

Version with separate housing



Note!

The maximum connection length between the probe and the separate housing is 6 m (L4). When ordering a Solicap S with a separate housing, the desired length must be specified.

If the connecting cable is to be shortened or passed through a wall, it must be separated from the process connection. See "Documentation" => "Operating Instructions" on → 85.

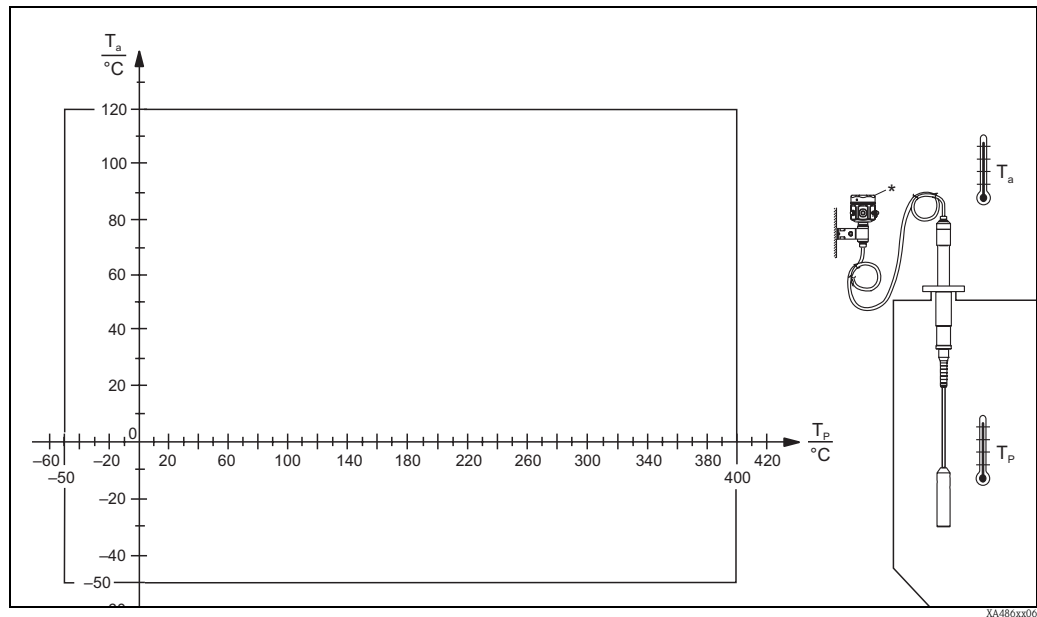

T_a = ambient temperature,

T_p = process temperature,

* temperature at separate housing: $-40\text{ °C} \leq T_a \leq 70\text{ °C}$

10.5.2 Process pressure range

-1 to 10 bar

The permitted pressure values depend on the flange selected. In the case of higher temperatures, the permitted pressure values can be taken from the following standards.

- pR EN 1092-1: 2005 table, Appendix G2
- ASME B 16.5a - 1998 Tab. 2-2.2 F316
- ASME B 16.5a - 1998 Tab. 2.3.8 N10276
- JIS B 2220

10.5.3 Application examples

Fly ash, sand, glass aggregate, gravel, molding sand, lime, ore (crushed), plaster, aluminum shavings, cement, pumice, dolomite, kaolin and similar bulk solids.

In general:

Bulk solids with a relative dielectric constant $\epsilon_r \geq 2.5$.

10.6 Other standards and guidelines

EN 60529

Degrees of protection by housing (IP code)

EN 61010

Safety requirements for electrical equipment for measurement, control and laboratory use

EN 61326

Interference emission (Class B equipment), interference immunity (Appendix A – Industrial).

NAMUR

Association for Standards for Control and Regulation in the Chemical Industry

IEC 61508

Functional safety

IEC 60947-5-6

Low-voltage switchgear and control gear; DC interface for proximity sensors and switching amplifiers (NAMUR)

10.7 Documentation



Note!

This documentation is available on the product pages at www.endress.com

10.7.1 Technical Information

- Nivotester FTL325N
TI353F/00/en
- Nivotester FTL375N
TI361F/00/en
- Solicap S FTI77
TI433F/00/en
- EMC test procedures
TI241F/00/en

10.7.2 Certificates

Safety information (ATEX)

- Solicap S FTI77
ATEX II 1 D Ex tD A20 IP65 T 90 °C,
ATEX II 1/2 D Ex tD A20/A21 IP65 T 100 °C
XA486F/00/a3

Control drawings

- Solicap S FTI77
FM: ZD243F/00/en
- Solicap S FTI77
CSA ZD225F/00/en

Functional safety

- Solicap S FTI77
SD278F/00/en

CRN registration

- CRN 0F1988.75

Other

- AD2000
The wetted material (316L) corresponds to AD2000 – W0/W2

10.7.3 Patents

This product is protected by at least one of the patents listed below. Further patents are under development.

- DE 103 22 279,
WO 2004 102 133,
US 2005 003 9528
- DE 203 13 695,
WO 2005 025 015

Index

A

- Activating fault diagnostics 76
- Alarm response 66, 69
- Ambient temperature range 81

B

- Basic settings 50
- Brief operating instructions 3
- Buildup mode. 57

C

- Cable specification 34
- Carrying out empty calibration 52
- Carrying out the empty and full calibration 54
- Carrying out the full calibration 53
- CE mark 12
- Climate class 81
- Commissioning 50
- Connecting the electronic insert FEI52 (DC PNP) 40
- Connecting the electronic insert FEI53 (3-WIRE) 41
- Connecting the electronic insert FEI54 (AC/DC with relay output) 42
- Connecting the electronic insert FEI55 (8/16 mA, SIL2/SIL3) 43
- Connecting the electronic insert FEI57S (PFM) 44
- Connecting the electronic insert FEI58 (NAMUR) 45
- Connection 38, 46
- Connection compartment 38

D

- Declaration of Conformity 12
- Declaration of Contamination 79
- Degree of protection 38
- Designated use 8
- Device identification 10
- Display elements 46
- Disposal 79

E

- Electromagnetic compatibility (EMC) 34, 82
- Electronic insert FEI51 (AC 2-wire) 39
- Extension heights for separate housing 28
- Exterior cleaning 73

F

- Fail-safe mode 80
- Fieldbus connector 35
- Firmware history 79
- Functional safety (SIL) 60

H

- Human interface 46

I

- Incoming acceptance 13
- Installation 13, 27
- Installation instructions 19

- Installation tools 28

M

- Maintenance 73
- Measuring conditions 27
- MIN/MAX fail-safe mode 60

N

- Nameplate 10
- Notes on safety conventions and icons 9

O

- Operational safety 8
- Output signal FEI51 64
- Output signal FEI52 64
- Output signal FEI53 67
- Output signal FEI54 65
- Output signal FEI55 65
- Output signal FEI57S 68
- Output signal FEI58 72
- Output signals 64

P

- Pipe mounting 33
- Post-installation check 33
- Potential equalization 34
- Preparing to install rope probes 23
- Preparing to install sword probes 20

R

- Range of sensor lengths 26
- Reference operating conditions 81
- Repair 73
- Repairing Ex-certified devices 73
- Replacement 73
- Reset 55
- Restoring factory settings 63
- Return 79

S

- Safety instructions 8
- Self-test 59
- Separate housing (Shortening the connecting cable) 30, 32
- Separate housing (wall and pipe mounting) 32
- Setting the measuring range 51, 67
- Shock resistance 82
- Shortening the probe 26
- Storage 13
- Storage temperature 13
- Switch behavior 80
- Switching delay 58
- Switchpoint adjustment 56

T

- Technical data 80
- Troubleshooting 76
- Troubleshooting instructions 76

Two-point control	57
U	
Upload/download Sensor DAT	62
W	
Wall holder unit	32
Wall mounting	33
Weather protection cover	74
Wiring	34

Declaration of Hazardous Material and De-Contamination *Erklärung zur Kontamination und Reinigung*

RA No.

Please reference the Return Authorization Number (RA#), obtained from Endress+Hauser, on all paperwork and mark the RA# clearly on the outside of the box. If this procedure is not followed, it may result in the refusal of the package at our facility.
Bitte geben Sie die von E+H mitgeteilte Rücklieferungsnummer (RA#) auf allen Lieferpapieren an und vermerken Sie diese auch außen auf der Verpackung. Nichtbeachtung dieser Anweisung führt zur Ablehnung ihrer Lieferung.

Because of legal regulations and for the safety of our employees and operating equipment, we need the "Declaration of Hazardous Material and De-Contamination", with your signature, before your order can be handled. Please make absolutely sure to attach it to the outside of the packaging.

Aufgrund der gesetzlichen Vorschriften und zum Schutz unserer Mitarbeiter und Betriebseinrichtungen, benötigen wir die unterschriebene "Erklärung zur Kontamination und Reinigung", bevor Ihr Auftrag bearbeitet werden kann. Bringen Sie diese unbedingt außen an der Verpackung an.

Type of instrument / sensor
Geräte-/Sensortyp _____

Serial number
Seriennummer _____

Used as SIL device in a Safety Instrumented System / *Einsatz als SIL Gerät in Schutzeinrichtungen*

Process data / *Prozessdaten* Temperature / *Temperatur* _____ [°F] _____ [°C] Pressure / *Druck* _____ [psi] _____ [Pa]
Conductivity / *Leitfähigkeit* _____ [µS/cm] Viscosity / *Viskosität* _____ [cp] _____ [mm²/s]

Medium and warnings
Warnhinweise zum Medium



	Medium / concentration <i>Medium / Konzentration</i>	Identification CAS No.	flammable <i>entzündlich</i>	toxic <i>giftig</i>	corrosive <i>ätzend</i>	harmful/ irritant <i>gesundheitsschädlich/ reizend</i>	other * <i>sonstiges*</i>	harmless <i>unbedenklich</i>
Process medium <i>Medium im Prozess</i>								
Medium for process cleaning <i>Medium zur Prozessreinigung</i>								
Returned part cleaned with <i>Medium zur Endreinigung</i>								

* explosive; oxidising; dangerous for the environment; biological risk; radioactive

* *explosiv; brandfördernd; umweltgefährlich; biogefährlich; radioaktiv*

Please tick should one of the above be applicable, include safety data sheet and, if necessary, special handling instructions.

Zutreffendes ankreuzen; trifft einer der Warnhinweise zu, Sicherheitsdatenblatt und ggf. spezielle Handhabungsvorschriften beilegen.

Description of failure / *Fehlerbeschreibung* _____

Company data / *Angaben zum Absender*

Company / <i>Firma</i> _____	Phone number of contact person / <i>Telefon-Nr. Ansprechpartner:</i> _____
Address / <i>Adresse</i> _____	Fax / E-Mail _____
_____	Your order No. / <i>Ihre Auftragsnr.</i> _____

"We hereby certify that this declaration is filled out truthfully and completely to the best of our knowledge. We further certify that the returned parts have been carefully cleaned. To the best of our knowledge they are free of any residues in dangerous quantities."

"Wir bestätigen, die vorliegende Erklärung nach unserem besten Wissen wahrheitsgetreu und vollständig ausgefüllt zu haben. Wir bestätigen weiter, dass die zurückgesandten Teile sorgfältig gereinigt wurden und nach unserem besten Wissen frei von Rückständen in gefährbringender Menge sind."

(place, date / *Ort, Datum*)

Name, dept./*Abt.* (please print / *bitte Druckschrift*)

Signature / *Unterschrift*

www.endress.com/worldwide

Endress+Hauser 
People for Process Automation

