



Level



Pressure



Flow



Temperature



Liquid
Analysis



Registration



Systems
Components



Services



Solutions

Operating Instructions

Nivotester FTW325

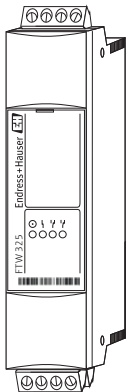













- de** - Grenzschalter
mit eigensicherem Signalstromkreis
- en** - Point Level Switch
with intrinsically safe signal circuit
- fr** - Détecteur de niveau
avec circuit signal à sécurité intrinsèque
- es** - Detector de nivel
con circuito de señal intrínsecamente seguro
- it** - Interruttore di livello
con circuito a sicurezza intrinseca
- nl** - Niveauschakelaar
met intrinsiekveilig sensorcircuit

KA00199F/00/A6/14.14
71269922

Endress+Hauser 
People for Process Automation

de - Inhalt	2	en - Contents	2	fr - Sommaire	2
Sicherheitshinweise	4	Notes on Safety	4	Conseils de sécurité	4
Geräte-Identifikation	6	Device Identification	6	Désignation de l'appareil	6
Messeinrichtung	8	Measuring system	8	Ensemble de mesure	8
Einbau	9	Installation	9	Montage	9
Anschluss	12	Connection	12	Raccordement	12
Einstellungen	15	Setting-up	15	Réglages	15
Master-Slave Funktion	25	Master-slave function	25	Fonction maître-esclave	25
Abgleich	26	Calibration	26	Etalonnage	26
Funktionstest	28	Function test	28	Test de fonction	28
Projektierungsbeispiele und deren Konfiguration	29	Examples for installation and configuration	29	Exemples d'installation et de configuration	29
Fehlersuche	41	Trouble-shooting	42	Recherche de défauts	43
Ergänzende Dokumentation	47	Supplementary Documentation	47	Documentation complémentaire	47

	Tipp		Tip		Tuyau
	Erlaubt		Allowed		Permis
	Verboten		Forbidden		Interdit
	Sichtkontrolle		Visual check		Contrôle visuel

es - Índice	3	it - Indice	3	nl - Inhoud	3
Notas sobre seguridad	5	Note sulla sicurezza	5	Veiligheidsinstructies	5
Identificación del equipo	6	Identificazione dello strumento	6	Instrument-identificatie	6
Sistema de medida	8	Sistema di misura	8	Meetopstelling	8
Montaje	9	Montaggio	9	Inbouw	9
Conexiones	12	Collegamenti	12	Aansluiting	12
Ajuste	15	Messa in marcia	15	Instellingen	15
Función maestro-esclavo	25	Master-funzione Slave	25	Master-slave functie	25
Calibración	26	Calibrazione	26	Afregeling	26
Prueba de funcionamiento	28	Test Funzione	28	Functietest	28
Ejemplos de instalación y configuración	29	Esempio di installazione e configurazione	29	Toepassingsvoorbeelden en configuratie	29
Identificación de fallos	44	Individuazione e eliminazione delle anomalie	45	Fout zoeken	46
Documentación adicional	47	Documentazione supplementare	47	Aanvullende documentatie	47



Consejo



Permitido



Prohibido



Control visual



Tip



Permesso



Proibito



Controllo visivo



Tip



Toegestaan



Verboden



visuele controle

de - Sicherheitshinweise

Der Nivotester FTW325 darf nur als konduktiver Grenzschalter verwendet werden.

Bei unsachgemäßem Einsatz können Gefahren von ihm ausgehen.

Das Gerät **darf nur von qualifiziertem und autorisiertem Fachpersonal** unter strenger Beachtung dieser Betriebsanleitung, der einschlägigen Normen, der gesetzlichen Vorschriften und der Zertifikate (je nach Anwendung) eingebaut, angeschlossen, in Betrieb genommen und gewartet werden.

Nur isoliertes Werkzeug verwenden!

Nur Originalteile verwenden!

en - Notes on Safety

The Nivotester FTW325 may only be used as a conductive measuring transmitter.

If used incorrectly it is possible that application-related dangers may arise.

The level limit device may be installed, connected, commissioned, operated and maintained **by qualified and authorised personnel only**, under strict observance of these operating instructions, any relevant standards, legal requirements, and, where appropriate, the certificate.

Use only insulated tools!

Use only original parts!

fr - Conseils de sécurité

Le Nivotester FTW325 est uniquement destiné à être utilisé comme détecteur de niveau conductif.

Il peut être source de danger en cas d'utilisation non conforme aux prescriptions.

L'appareil ne doit être installé, raccordé, mis en service et maintenu **que par un personnel qualifié et autorisé**, qui tiendra compte des indications contenues dans la présente mise en service, des normes en vigueur et des certificats disponibles (selon l'application).

Utilisez uniquement des outils isolés!

Utilisez uniquement des pièces d'origine!

es - Notas sobre seguridad

El Nivotester FTW325 únicamente puede ser utilizado como transmisor conductivo de medida. Su empleo inapropiado puede resultar peligroso.

El equipo deberá ser montado, conectado, instalado y mantenido única y **exclusivamente por personal cualificado y autorizado**, bajo rigurosa observación de las presentes instrucciones de servicio, de las normativas y legislaciones vigentes, así como de los certificados (dependiendo de la aplicación).

Utilice solamente herramientas aisladas!

Use sólo las piezas originales!

it - Note sulla sicurezza

Il Nivotester FTW325 può essere utilizzato solo come sistema conduttivo.

Un'installazione non corretta può determinare pericolo.

Lo strumento FTW325 deve essere montato, connesso, messo in funzione ed operato **solamente da personale qualificato ed autorizzato**, sotto la stretta osservazione delle presenti norme di installazione e manutenzione e delle ulteriori norme, regolamenti, disposizioni legali e, dove richiesto, dei certificati appropriati.

Utilizzare solo strumenti isolati!

Utilizzare solo parti originali!

nl - Veiligheidsinstructies

De Nivotester FTW325 mag uitsluitend als geleidbaarheids-niveauschakelaar gebruikt worden.

Indien niet correct gebruikt kunnen gevaarlijke situaties ontstaan.

Het instrument alleen door **gekwalificeerd en geautoriseerd personeel** laten inbouwen, aansluiten, in bedrijf nemen en onderhouden. Neem de instructies in deze Inbedrijfstellingsvoorschriften de desbetreffende normen, de wettelijke voorschriften en eventuele certificaten in acht.

Gebruik uitsluitend geïsoleerd gereedschap!

Gebruik alleen originele onderdelen!

de - Identifikation

Folgende Möglichkeiten stehen zur Identifizierung des Messgeräts zur Verfügung:

- Typenschildangaben
- Bestellcode (Order code) mit Aufschlüsselung der Gerätemerkmale auf dem Lieferschein

fr - Dénomination

Les options suivantes sont disponibles pour l'identification de l'appareil:

- Indications de la plaque signalétique
- Référence de commande (Order code) avec énumération des caractéristiques de l'appareil sur le bordereau de livraison

it - Identificazione

Per l'identificazione del misuratore sono disponibili le seguenti opzioni:

- dati della targhetta
- codice d'ordine con lista delle caratteristiche del dispositivo sul documento di trasporto

en - Identification

The following options are available for identification of the measuring device:

- Nameplate specifications
- Order code with breakdown of the device features on the delivery note

es - Identificación

Las opciones siguientes están disponibles para la identificación del dispositivo de medición:

- Especificaciones de la placa de identificación
- Código de pedido con desglose de las características del dispositivo en el albarán de entrega

nl - Identificatie

De volgende mogelijkheden bestaan om het meetinstrument te identificeren:

- specificaties op de typeplaat
- codice d'ordine con lista delle caratteristiche del dispositivo sul documento di trasporto

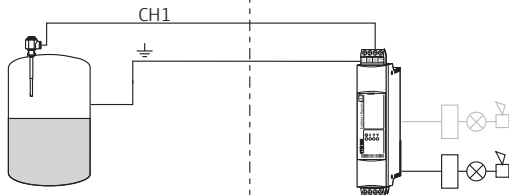

CH1 (MAX)
CH2 (MIN)

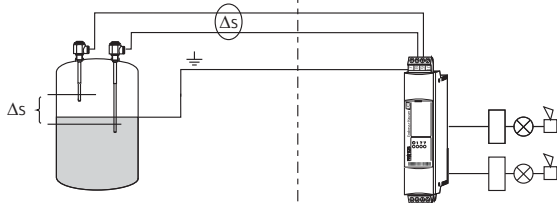
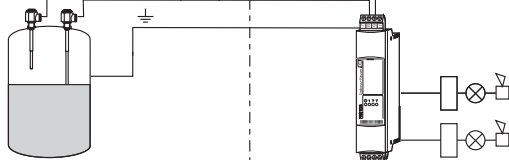

de - Messeinrichtung
en - Measuring system
fr - Ensemble de mesure
es - Sistema de medida
it - Sistema di misura
nl - Meetopstelling

de - Einbau
en - Mounting
fr - Montage
es - Montaje
it - Montaggio
nl - Foutieve

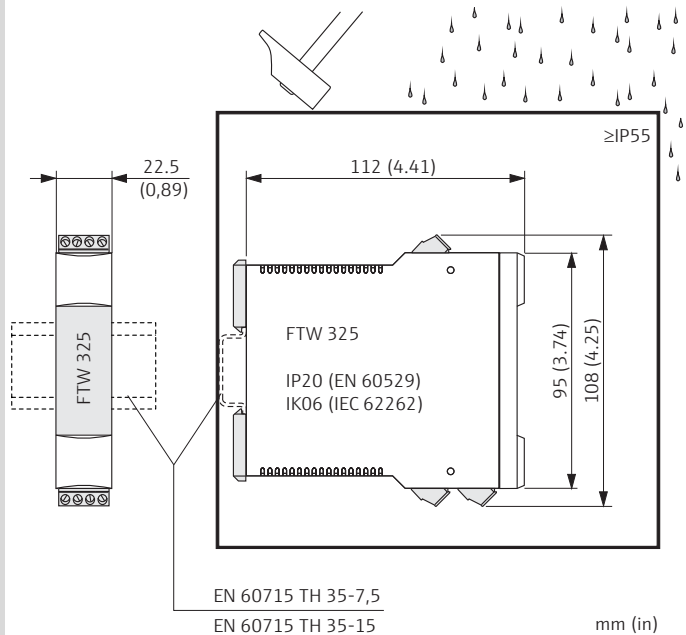

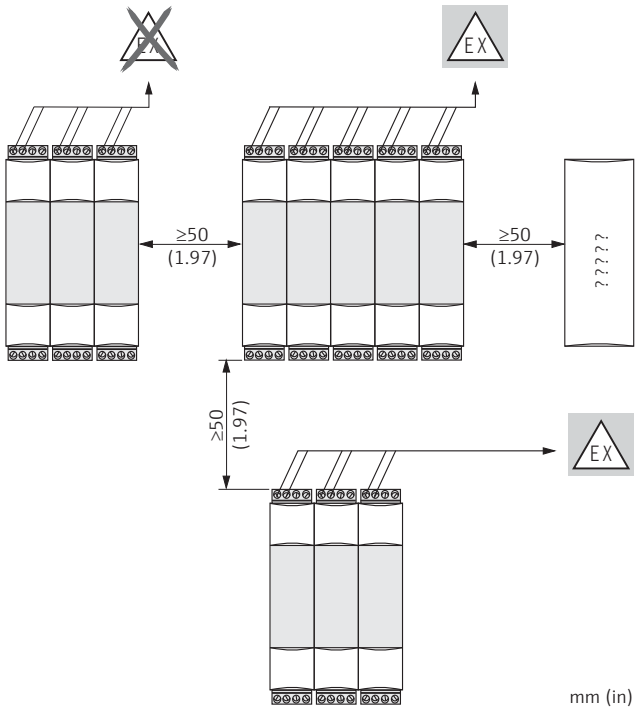

de - Mindestabstände

en - Minimum separation

fr - Intervalle min. entre deux appareils

es - Distancia mínima

it - Distanze minime

nl - Minimale afstand

de - A: Montage auf Hutschiene

B: Demontage

1. Klemmenblöcke entfernen
2. Gerät abnehmen

en - A: Rail mounting

B: Dismantling

1. Remove the terminal blocks
2. Remove the unit

fr - A: Montage sur rail profilé

B: Démontage

1. Déconnecter les borniers
2. Oter l'appareil

es - A: Montaje en raíl

B: Desmontaje

1. Quitar los bornes de conexión
2. Quitar el instrumento

it - A: Montaggio su rotaia

B: Smontaggio

1. Togliere il blocchetto morsetti
2. Togliere lo strumento

nl - A: Railmontage

B: Uitbouw

1. Klemmenblok verwijderen
2. Instrument verwijderen

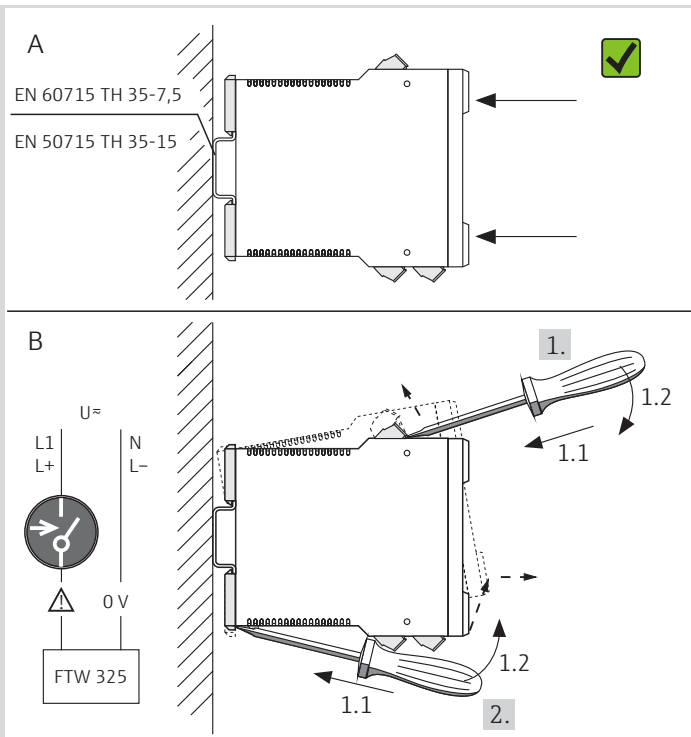

Typenschild beachten!

Note name plate!

Tenir compte de la plaque signalétique!

Ver identificación!

Targhetta note!

Typeplaatje bekijken!

N L1 $U \sim 85 \dots 253 \text{ V (AC)}$
50/60 Hz

L- L+ $U \approx 20 \dots 60 \text{ V (DC)}$

N L1 $U \sim 20 \dots 30 \text{ V (AC)}$
50/60 Hz

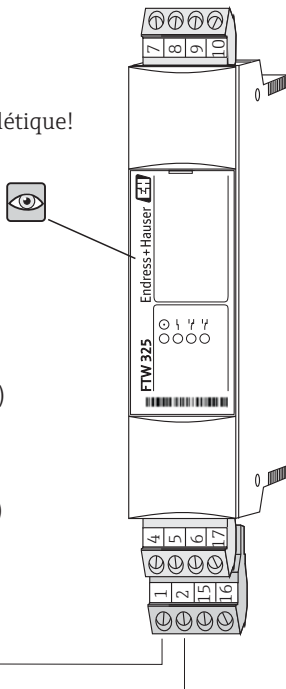

de - Anschluss

Anordnung der Klemmen
Hilfsenergie

en - Connection

Terminal arrangement
Power supply

fr - Raccordement

Agencement des bornes
Alimentation

es - Conexiones

Asignación de terminales
Alimentación

it - Collegamenti

Ordinamento dei terminali
Alimentazione

nl - Aansluiting

Klemmen positie
Voedingspanning

de - Anschluss der Messaufnehmer

en - Sensor connection

fr - Raccordement des capteurs

es - Conexión de sensor

it - Connessione sensore

nl - Aansluiting van de sensor

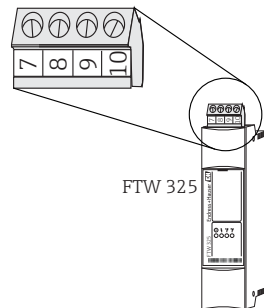
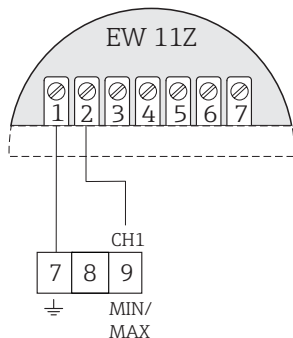
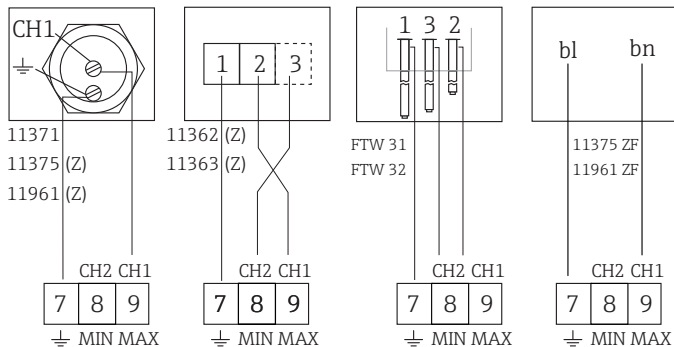



Grenzsinal / Limit signal /
Signal de seuil / Señal de límite /
Soglia d'intervento / Niveausignaal

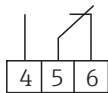

CH1



Grenzsinal / Limit signal /
Signal de seuil / Señal de límite /
Soglia d'intervento / Niveausignaal



CH2



Störung / Fault /
Défaut / Fallo /
Guasto / Storing



V
oder /
or /
ou /
o /
o /
of

U_{\sim} max. 250 V (AC)
 I_{\sim} max. 2 A (AC)
 P_{\sim} max. 500 VA / $\cos \varphi \geq 0,7$
 U_{\rightleftharpoons} max. 40 V (DC)
 I_{\rightleftharpoons} max. 2 A (DC)
 P_{\rightleftharpoons} max. 80 W

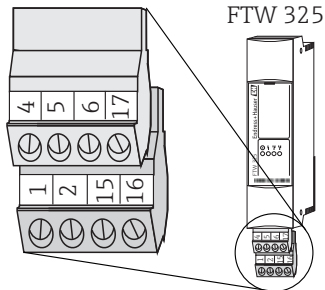

de - Anschluss der Ausgänge
en - Output connection
fr - Raccordement des sorties
es - Conexión de la salida
it - Connessione d'uscita
nl - Aansluiting van de uitgangen

de - Einstellungen
 en - Setting-up
 fr - Réglages
 es - Ajuste
 it - Messa in marcia
 nl - Instellingen

Lichtsignale:
 Light signals:
 Signaux lumineux :
 Señales luminosas:
 Segnali luminosi:
 Lichtsignalen:

 leuchtet / on / allumée /
 iluminado / on / aan

 aus / off / éteinte /
 apagado / off / uit

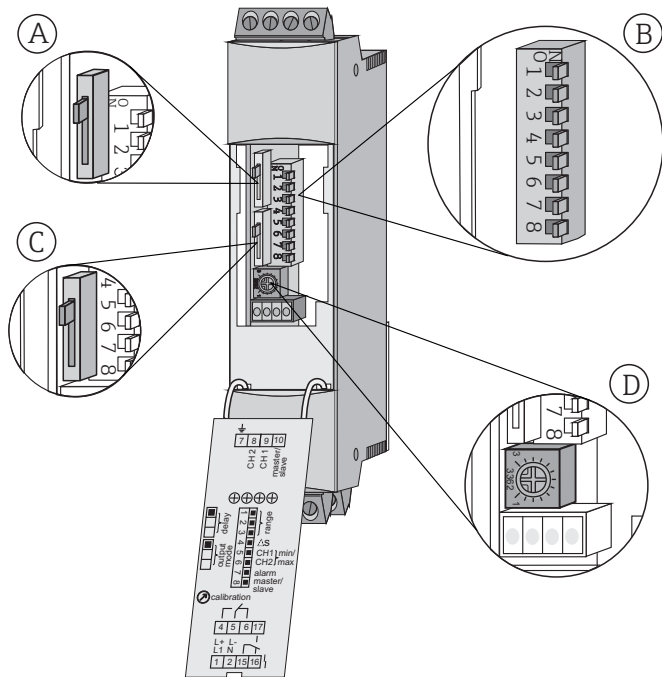

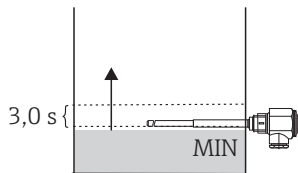
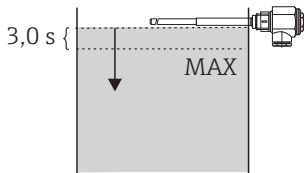
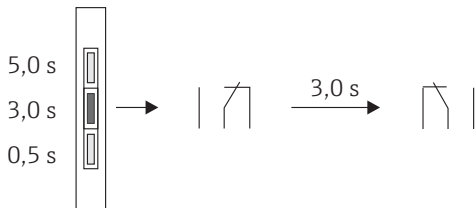
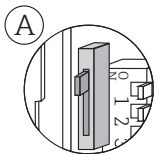

de - Schaltverzögerung einstellen

5,0 s (oben)

3,0 s (mitte)

0,5 s (unten)

en - Setting switching delay

5.0 s (top)

3.0 s (centre)

0.5 s (bottom)

fr - Réglage de la temporisation

5,0 s (en haut)

3,0 s (milieu)

0,5 s (en bas)

es - Ajuste del temporizador

5,0 s (en alto)

3,0 s (en medio)

0,5 s (abajo)

it - Citardo di commutazione

5,0 s (alto)

3,0 s (centro)

0,5 s (basso)

nl - Tijdvertraging instellen

5,0 s (boven)

3,0 s (midden)

0,5 s (onder)

de - Betriebsart des zweiten Ausgangsrelais
Füllstand oder Alarm

en - Mode of operation of second output relay
Level or alarm

fr - Rode de fonctionnement du second relais de sortie
Niveau ou alarme

es - Modo de funcionamiento del segundo relé de salida
Nivel o alarma

it - Modalità operativa della seconda uscita relè
Soglia di livello o allarme

nl - Functie keuze van het tweede uitgangsrelais
Niveau of alarm

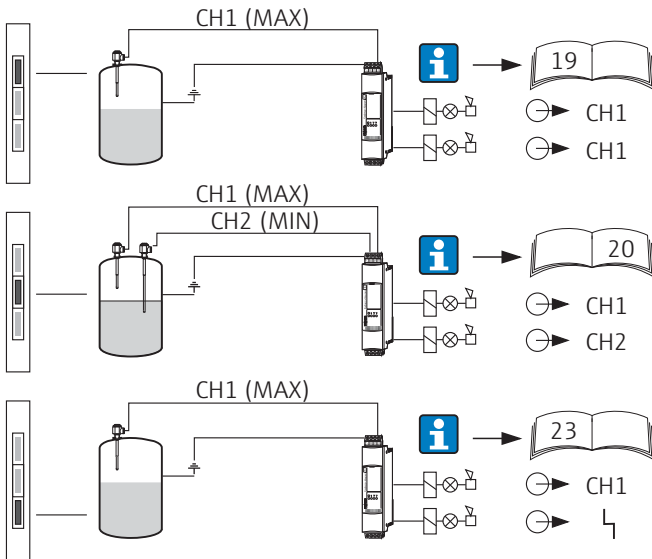
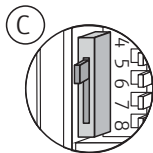

1.

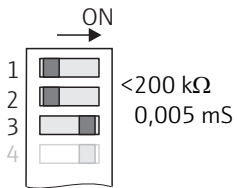
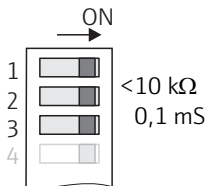
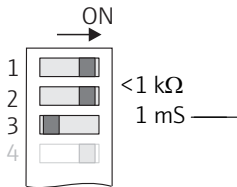

HIGH LOW

Leitfähigkeit/conductivity/conductivité/conductividad/
conducibilità/geleidbaarheid

Empfindlichkeit/sensitivity/sensibilité/sensibilidad/
sensibilità/ gevoeligheid

LOW HIGH

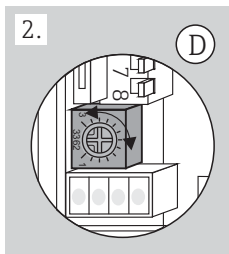
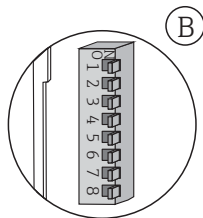

de - DIL-Schalter:

1. Widerstandsbereich einstellen
2. Feinabgleich durchführen

en - DIL switch:

1. Setting resistance range
2. Perform fine calibration

fr - Rommutateur DIL:

1. Régler la gamme de résistance
2. Procéder à l'étalonnage fin

es - Interruptor DIL:

1. Selección del rango de resistencia
2. Ajuste de calibración fina

it - Commutatore DIL:

1. Impostazione del campo di resistenza
2. Calibrazione fine

nl - DIP-schakelaar:

1. Weerstandsbereik uitvoeren
2. Fijnafregeling uitvoeren

- de** - DIL-Schalter:
 Δ s-Funktion
 Zweipunktsteuerung
- en** - DIL switch:
 Δ s function
 Two-point control
- fr** - Commutateur DIL:
 Fonction Δ s
 Régulation entre deux points
- es** - Interruptor DIL:
 Función Δ s
 Control entre dos puntos
- it** - Commutatore DIL:
 Funzione Δ s
 Per il controllo su due punti
- nl** - DIP-schakelaar:
 Δ s-functie
 2-puntsregeling

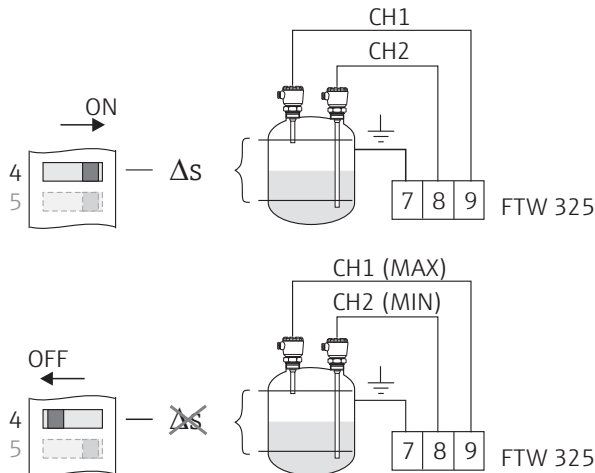
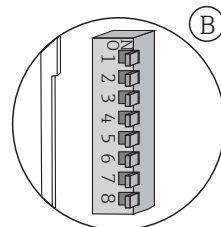

Sicherheits-
schaltung
Fail-safe circuit
Circuit de sécurité
Circuito
de seguridad
Circuito
di sicurezza
Fail-safe keuze

Füllstand
Level
Niveau
Nivel
Livello
Niveau

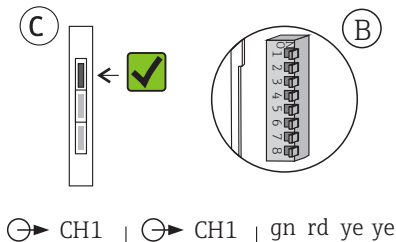

de - DIL-Schalter:
MIN/MAX-Sicherheit
2 x CH1
Leitungsüberwachung (OFF)

en - DIL switch:
MIN/MAX safety
2 x CH1
Line monitoring (OFF)

fr - Commutateur DIL:
Sécurité MIN/MAX
2 x CH1
Surveillance de ligne (OFF)

es - Interruptor DIL:
Seguridad MIN/MAX
2 x CH1
Monitorización de línea (OFF)

it - Commutatore DIL:
Sicurezza di MIN/MAX
2 x CH1
Monitoraggio della linea (OFF)

nl - IP-schakelaar:
MIN/MAX-fail safe
2 x CH1
Kabelbewaking (OFF)

		⊙ CH1	⊙ CH1	gn rd ye ye ● ● ● ●
MAX				
OFF				
MIN				
ON				

de - DIL-Schalter:
MIN/MAX-Sicherheit
CH1 und CH2
Leitungsüberwachung (OFF)

en - DIL switch:
MIN/MAX safety
CH1 and CH2
Line monitoring (OFF)

fr - Commutateur DIL:
Sécurité MIN/MAX
CH1 et CH2
Surveillance de ligne (OFF)

es - Interruptor DIL:
Seguridad MIN/MAX
CH 1 y CH 2
Monitorización de línea (OFF)

it - Commutatore DIL:
Sicurezza di MIN/MAX
CH1 e CH2
Monitoraggio della linea (OFF)

nl - DIP-schakelaar:
MIN/MAX-fail safe
CH1 en CH2
Kabelbewaking (OFF)

Sicherheits-
schaltung
Fail-safe circuit
Circuit de sécurité
Circuito
de seguridad
Circuito
di sicurezza
Fail-safe keuze

Füllstand
Level
Niveau
Nivel
Livello
Niveau

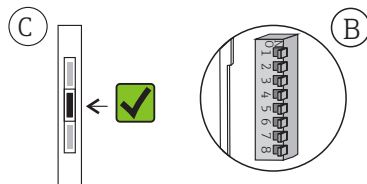

⊖ CH1

⊖ CH2

gn rd ye ye



CH1 = MAX
CH2 = MIN

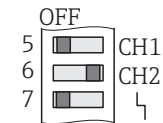

CH1 = MIN
CH2 = MAX

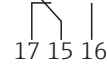
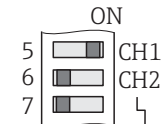
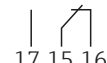

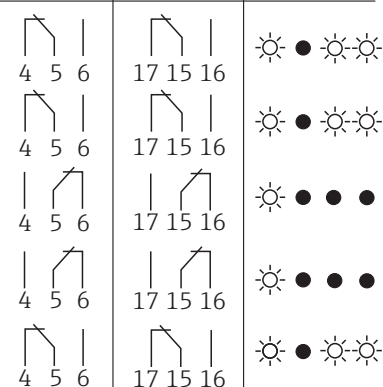
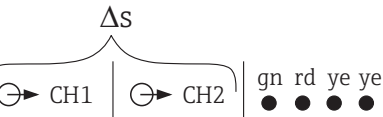
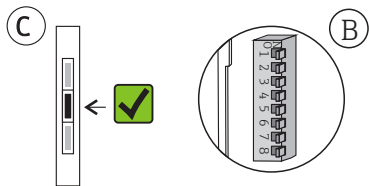

Sicherheits-
schaltung
Fail-safe circuit
Circuit de sécurité
Circuito
de seguridad
Circuito
di sicurezza
Fail-safe keuze

Füllstand
Level
Niveau
Nivel
Nivel
Livello
Niveau

$\Delta s = \{$

MAX + Δs

ON

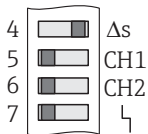

de - DIL-Schalter:
MAX-Sicherheit
 Δs (CH1 + CH2)
Leitungsüberwachung (OFF)

en - DIL switch:
MAX safety
 Δs (CH1 + CH2)
Line monitoring (OFF)

fr - Commutateur DIL:
Sécurité MAX
 Δs (CH1 + CH2)
Surveillance de ligne (OFF)

es - Interruptor DIL:
Seguridad MAX
 Δs (CH1 + CH2)
Monitorización de línea (OFF)

it - Commutatore DIL:
Sicurezza di MAX
 Δs (CH1 + CH2)
Monitoraggio della linea (OFF)

nl - DIP-schakelaar:
MAX-fail safe
 Δs (CH1 + CH2)
Kabelbewaking (OFF)

de - DIL-Schalter:
 MIN-Sicherheit
 Δs (CH1 + CH2)
 Leitungsüberwachung (OFF)

en - DIL switch:
 MIN safety
 Δs (CH1 + CH2)
 Line monitoring (OFF)

fr - Commutateur DIL:
 Sécurité MIN
 Δs (CH1 + CH2)
 Surveillance de ligne (OFF)

es - Interruptor DIL:
 Seguridad MIN
 Δs (CH1 + CH2)
 Monitorización de línea (OFF)

it - Commutatore DIL:
 Sicurezza di MIN
 Δs (CH1 + CH2)
 Monitoraggio della linea (OFF)

nl - DIP-schakelaar:
 MIN-fail safe
 Δs (CH1 + CH2)
 Kabelbewaking (OFF)

Sicherheits-
 schaltung
 Fail-safe circuit
 Circuit de sécurité
 Circuito
 de seguridad
 Circuito
 di sicurezza
 Fail-safe keuze

Füllstand
 Level
 Niveau
 Niveau
 Niveau
 Livello
 Niveau

$\Delta s = \{$

MIN + Δs

ON

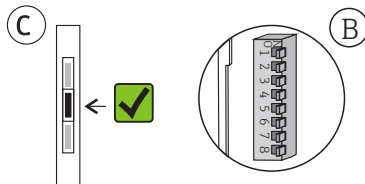
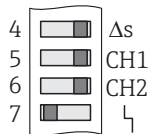

Δs

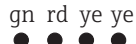
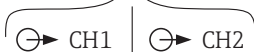

Sicherheits-
schaltung
Fail-safe circuit
Circuit de sécurité
Circuito
de seguridad
Circuito
di sicurezza
Fail-safe keuze

Füllstand
Level
Niveau
Nivel
Livello
Niveau

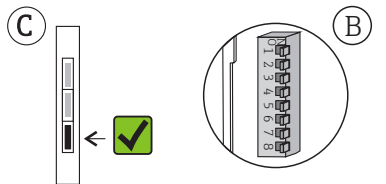

⊖ CH1 ⊖ gn rd ye ye

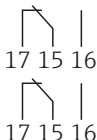
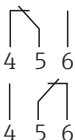
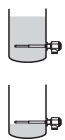
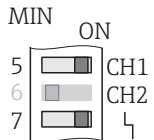
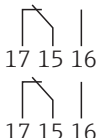
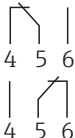
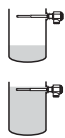
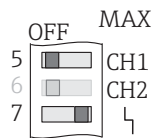

Störung / Fault /
Défaut / Fallo /
Guasto / Storing

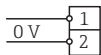

de - DIL-Schalter:
MIN/MAX-Sicherheit
CH1 + Störmeldung
Leitungsüberwachung (ON)

en - DIL switch:
MIN/MAX safety
CH1 + fault message
Line monitoring (OFF)

fr - Commutateur DIL:
Sécurité MIN/MAX
CH1 + message alarme
Surveillance de ligne (ON)

es - Interruptor DIL:
Seguridad MIN/MAX
CH 1 + mensaje de alarma
Monitorización de línea (ON)

it - Commutatore DIL:
Sicurezza di MIN/MAX
CH1 + malfunzionamento
Monitoraggio della linea (ON)

nl - DIP-schakelaar:
MIN/MAX-fail safe
CH1 + foutmelding
Kabelbewaking (ON)

de - Master-Slave Funktion

Synchronisation der Phasen einstellen

en - Master-slave function

Setting the synchronisation of the phases

fr - Fonction maître-esclave

Réglage de la synchronisation de phase

es - Función maestro-esclavo

Ajuste de la sincronización de las fases

it - Master-funzione Slave

Funzioen di sincronizzazione delle fasi

nl - Master-slave functie

Synchronisatie van de fasen instellen

MASTER _____
SLAVE
0

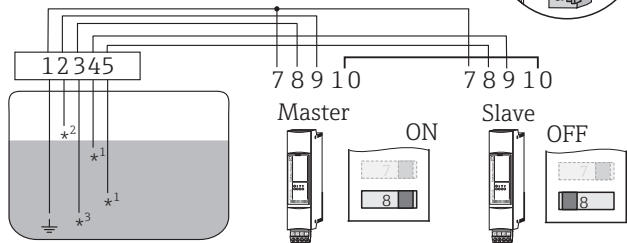
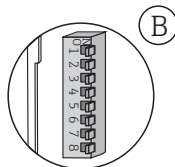

0 ~~MASTER~~ ~~SLAVE~~

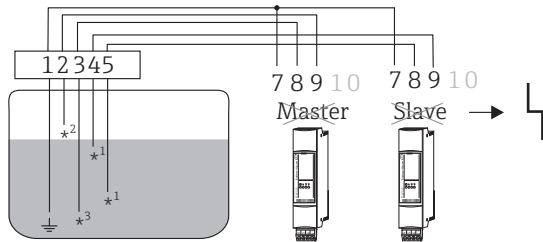

*1 Δs
*2 MAX
*3 MIN

1. (B) → ON

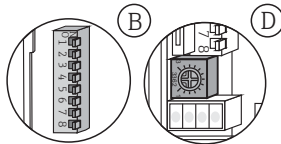
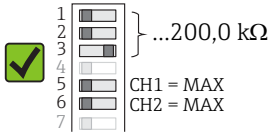

2. CH2 CH1

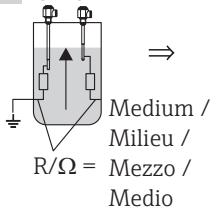

3.

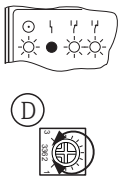

4.

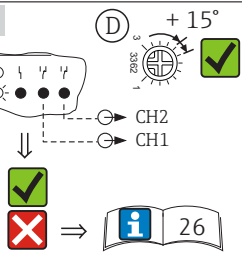

5. CH2 CH1

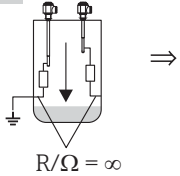

6.

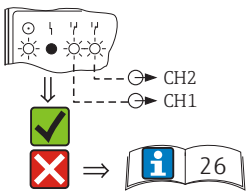

de - Abgleich

Standardeinstellung!
Für leitfähige Flüssigkeiten

en - Calibration

Standard setting!
For conductive liquids

fr - Etalonnage

Réglage standard!
Pour liquides conducteurs

es - Calibración

Ajuste estándar!
Para líquidos conductivos

it - Calibrazione

Impostazione Standard!
Per liquidi conduttivi

nl - Afregeling

Standaardinstelling!
Voor geleidende vloeistoffen

de - Widerstandsbereich bis
10,0 k Ω

en - Resistance range to
10,0 k Ω

fr - Gamme de résistance jusqu'à
10,0 k Ω

es - Rango de resistencia hasta
10,0 k Ω

it - Campo resistenza fino a
10,0 k Ω

nl - Weerstandsbereik tot
10,0 k Ω

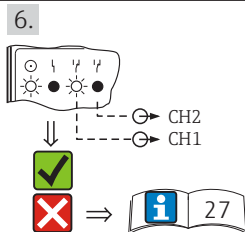
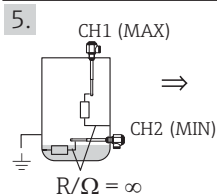
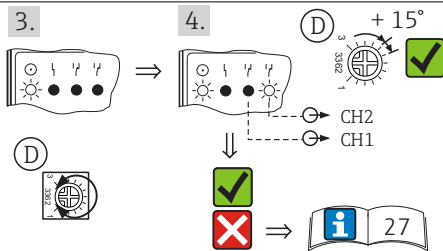
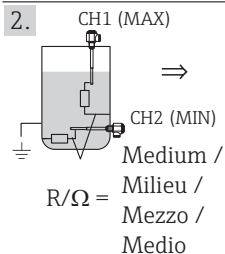
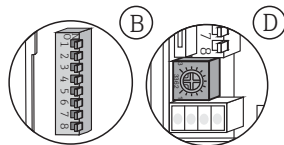
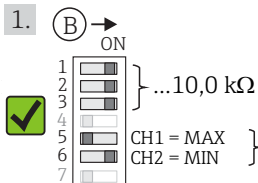

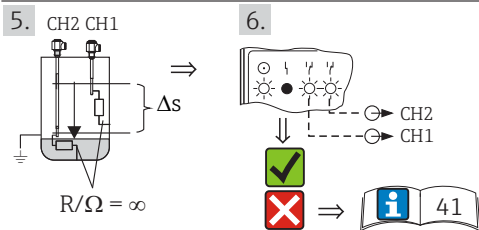
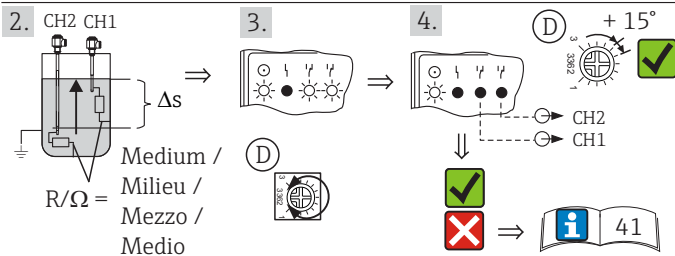
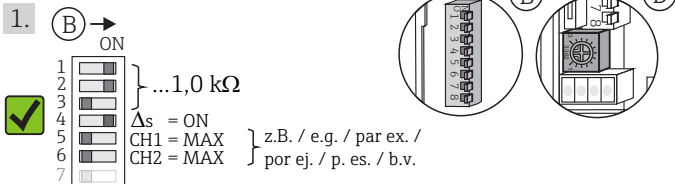

de - Widerstandsbereich bis
1,0 k Ω

en - Resistance range to
1,0 k Ω

fr - Gamme de résistance jusqu'à
1,0 k Ω

es - Rango de resistencia hasta
1,0 k Ω

it - Campo resistenza fino a
1,0 k Ω

nl - Weerstandsbereik tot
1,0 k Ω

de - Funktionstest

Füllstandalarm 1. - 3. und
Störmeldung 4. - 9.

en - Function test

Level alarm 1. - 3. and
fault message 4. - 9.

fr - Test de fonction

Alarme de niveau 1. - 3. et
message alarme 4. - 9.

es - Prueba de funcionamiento

Alarma de nivel 1. - 3. y
mensaje de alarma 4. - 9.

it - Test funzione

Allarme livello 1. - 3.
malfunzionamento 4. - 9.

nl - Functietest

Niveau-alarm 1. - 3. en
foutalarm 4. - 9.

z.B. / e.g. / par ex. / por ej. / p. es. / b.v. MAX

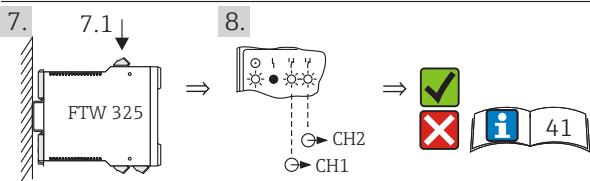
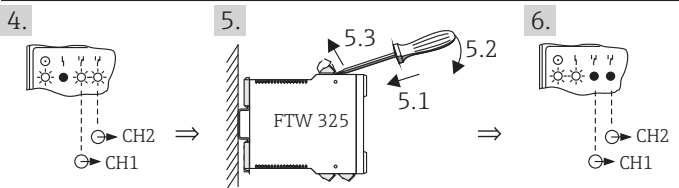
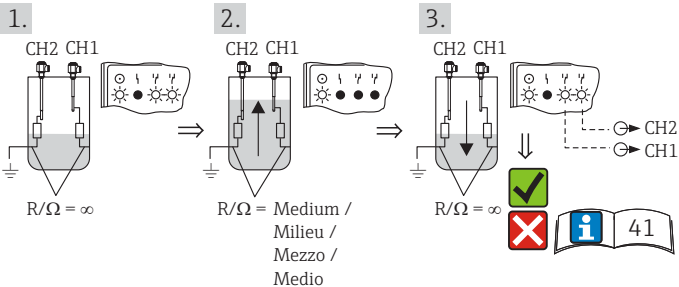

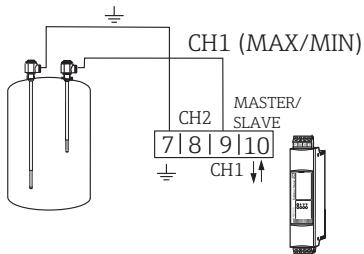

Output CH1

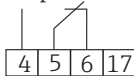

L1 N
L+ L- Alarm Signal

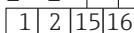

Power supply

Switch setting

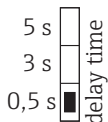

delay time

CH1 output parallel
CH2 output separate
1CH with alarm



output mode

off on

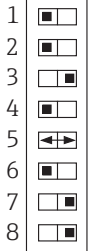

1 .. 1 k Ω
2 .. 10 k Ω
3 .. 200 k Ω } sensitivity
4 Δ S (OFF)
5 CH1 (MAX/MIN)
6 CH2 (MAX)
7 Alarm (ON)
8 Slave/Master (Master)



Calibration

de - Projektierungsbeispiele und deren Konfiguration

Einkanalbetrieb mit Alarmüberwachung

en - Examples for installation and configuration

One channel mode with alarm signal

fr - Exemples d'installation et de configuration

Mode une voie avec signal alarme

es - Ejemplos de instalación y configuración

Versión de un canal con señal de alarma

it - Esempio di installazione e configurazione

Modalità a un canale con segnale d'allarme

nl - Toepassingsvoorbeelden en configuratie

Éénkanaalsfunctie met functiealarm

- de** - Einkanalbetrieb ohne Alarmüberwachung (Ausgänge parallel)
- en** - One channel mode without alarm signal (outputs parallel)
- fr** - Mode une voie sans signal alarme (sorties parallèles)
- es** - Versión de un canal sin señal de alarma (salidas paralelas)
- it** - Modalità a un canale senza segnale d'allarme (uscite in parallelo)
- nl** - Éénkanaalsfunctie zonder functiealarm (uitgangen parallel)

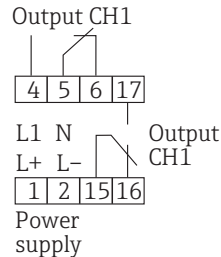
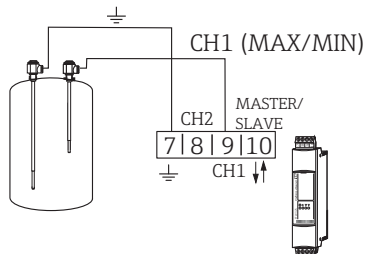

Switch setting



Calibration

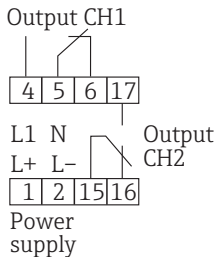
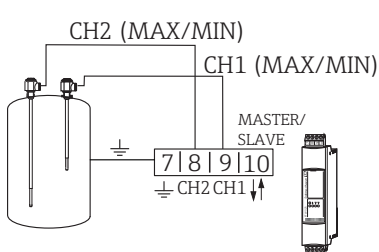

Switch setting

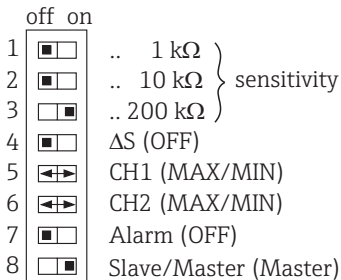
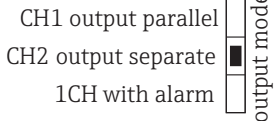
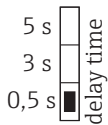

Calibration

de - Zweikanalbetrieb
(Ausgänge separat)

en - Two channel mode
(outputs separate)

fr - Mode deux voies
(sorties séparées)

es - Versi ón de dos canales
(salidas separadas)

it - Modalità a due canali
(uscite separate)

nl - Tweekanaalsfunctie
(uitgangen separaat)

- de** - Zweipunktregelung (Δs) mit Alarmüberwachung
- en** - control Two-point control (Δs) with alarm signal
- fr** - Régulation entre deux points (Δs) avec signal alarme
- es** - Dos puntos de control (Δs) con señal de alarma
- it** - Controllo su due punti (Δs) con segnale d'allarme
- nl** - Twee-punts regeling (Δs) met functiealarm

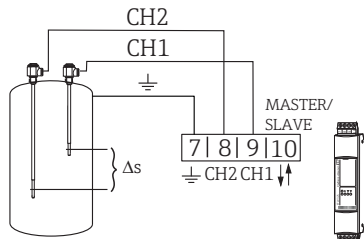

Output Δs - Signal

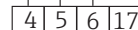

L1 N Alarm Signal
L+ L-

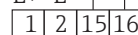

Power supply

Switch setting

5 s
3 s
0,5 s



delay time

CH1 output parallel
CH2 output separate
1CH with alarm



output mode

off on

1
2
3
4
5
6
7
8

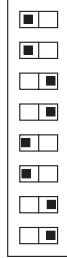

.. 1 k Ω } sensitivity
.. 10 k Ω }
.. 200 k Ω }
 ΔS (ON)
CH1 (MAX)
CH2 (MAX)
Alarm (ON)
Slave/Master (Master)



Calibration

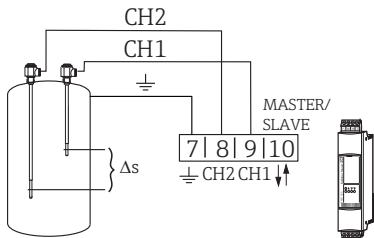

Output Δs - Signal

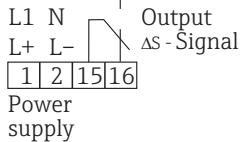
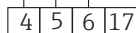

Switch setting

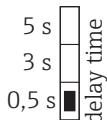

delay time

off on

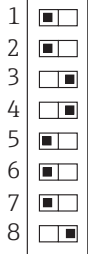

.. 1 k Ω } sensitivity
 .. 10 k Ω }
 .. 200 k Ω }
 ΔS (ON)
 CH1 (MAX)
 CH2 (MAX)
 Alarm (OFF)
 Slave/Master (Master)

CH1 output parallel
 CH2 output separate
 1CH with alarm

output mode



Calibration

- de** - Zweipunktregelung (Δs) ohne Alarmüberwachung (Ausgänge parallel)
- en** - Two-point control (Δs) without alarm signal (outputs parallel)
- fr** - Régulation entre deux points (Δs) sans signal alarme (sorties parallèles)
- es** - Dos puntos de control (Δs) sin señal de alarma (salidas paralelas)
- it** - Controllo su due punti (Δs) senza segnale d'allarme (uscite in parallelo)
- nl** - Twee-punts regeling (Δs) zonder functiealarm (uitgangen parallel)

- de** - Zweikanalbetrieb
(Ausgänge separat)
- en** - Two channel mode
(outputs separate)
- fr** - Mode deux voies
(sorties séparées)
- es** - Versi ón de dos canales
(salidas separadas)
- it** - Modalità a due canali
(uscite separate)
- nl** - Tweekanaalsfunctie
(uitgangen separaat)

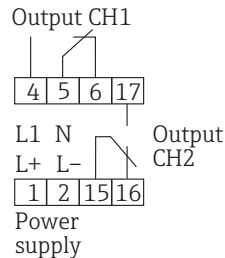
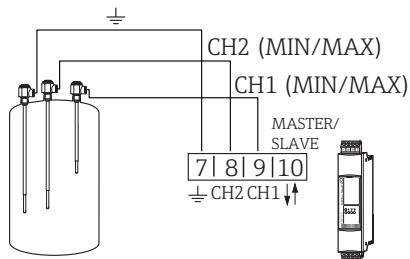

Switch setting

5 s	delay time	1	<input type="checkbox"/>	.. 1 k Ω	} sensitivity
3 s		2	<input type="checkbox"/>	.. 10 k Ω	
0,5 s		3	<input checked="" type="checkbox"/>	.. 200 k Ω	
	output mode	4	<input checked="" type="checkbox"/>	ΔS (OFF)	
CH1 output parallel		5	<input checked="" type="checkbox"/>	CH1 (MIN/MAX)	
CH2 output separate		6	<input checked="" type="checkbox"/>	CH2 (MIN/MAX)	
1CH with alarm		7	<input type="checkbox"/>	Alarm (OFF)	
		8	<input type="checkbox"/>	Slave/Master (Master)	



Calibration

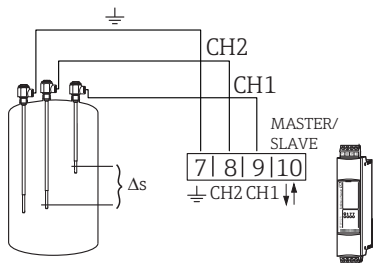

Output Δs - Signal

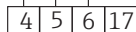

L1 N
L+ L- Alarm Signal

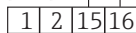

Power supply

Switch setting

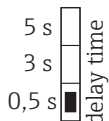

delay time

CH1 output parallel
CH2 output separate
1CH with alarm



output mode

off on

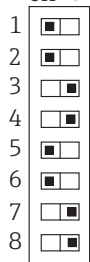

.. 1 k Ω }
.. 10 k Ω } sensitivity
.. 200 k Ω }
 ΔS (ON)
CH1 (MAX)
CH2 (MAX)
Alarm (ON)
Slave/Master (Master)



Calibration

- de** - Zweipunktregelung (Δs) mit Alarmüberwachung
- en** - control Two-point control (Δs) with alarm signal
- fr** - Régulation entre deux points (Δs) avec signal alarme
- es** - Dos puntos de control (Δs) con señal de alarma
- it** - Controllo su due punti (Δs) con segnale d'allarme
- nl** - Twee-punts regeling (Δs) met functiealarm

- de** - Zweipunktregelung (Δs) ohne Alarmüberwachung (Ausgänge parallel)
- en** - Two-point control (Δs) without alarm signal (outputs parallel)
- fr** - Régulation entre deux points (Δs) sans signal alarme (sorties parallèles)
- es** - Dos puntos de control (Δs) sin señal de alarma (salidas paralelas)
- it** - Controllo su due punti (Δs) senza segnale d'allarme (uscite in parallelo)
- nl** - Twee-punts regeling (Δs) zonder functiealarm (uitgangen parallel)

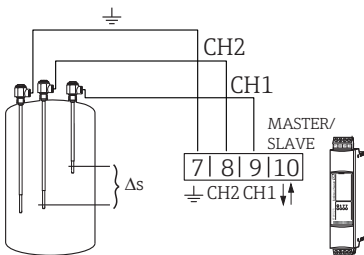

Output Δs - Signal

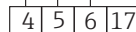

Output Δs - Signal

Power supply

Switch setting

5 s	delay time	1	<input type="checkbox"/>	off	.. 1 k Ω	} sensitivity
3 s		2	<input type="checkbox"/>	on	.. 10 k Ω	
0,5 s		3	<input checked="" type="checkbox"/>		.. 200 k Ω	
	output mode	4	<input type="checkbox"/>	<input checked="" type="checkbox"/>	ΔS (ON)	
CH1 output parallel		5	<input checked="" type="checkbox"/>	<input type="checkbox"/>	CH1 (MAX)	
CH2 output separate		6	<input checked="" type="checkbox"/>	<input type="checkbox"/>	CH2 (MAX)	
1CH with alarm		7	<input checked="" type="checkbox"/>	<input type="checkbox"/>	Alarm (OFF)	
		8	<input type="checkbox"/>	<input checked="" type="checkbox"/>	Slave/Master (Master)	



Calibration

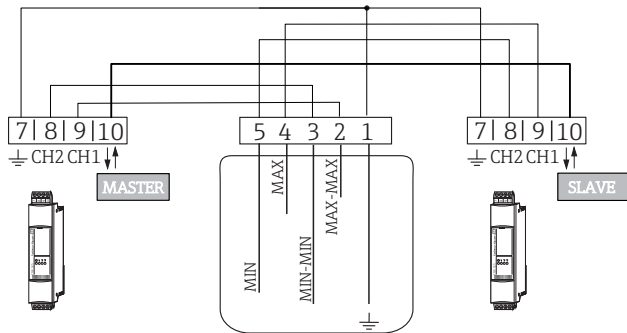

de - Vierkanalbetrieb
(MIN bzw. MAX beliebig kombiniert)

en - Four channel mode
(MIN resp. MAX arbitrary combined)

fr - Mode quatre voies
(MIN resp. MAX, combinées de façon aléatoire)

es - Versión de cuatro canales
(Min resp. Máx)
Combinación arbitraria

it - Modalità a quattro canali
(combinazione arbitraria
MIN risp. MAX)

nl - Vierkanaalsfunctie
(MIN resp. MAX willekeurig gecombineerd)

Master

Output CH1

4 5 6 17

L1 N
L+ L- Output CH2

1 2 15 16

Power supply

Slave

Output CH1

4 5 6 17

L1 N
L+ L- Output CH2

1 2 15 16

Power supply

- de** - Vierkanalbetrieb
(MIN bzw. MAX beliebig kombiniert)
- en** - Four channel mode
(MIN resp. MAX arbitrary combined)
- fr** - Mode quatre voies
(MIN resp. MAX, combinées de façon aléatoire)
- es** - Versión de cuatro canales
(Min resp. Máx)
Combinación arbitraria
- it** - Modalità a quattro canali
(combinazione arbitraria MIN risp. MAX)
- nl** - Vierkanaalsfunctie
(MIN resp. MAX willekeurig gecombineerd)

Switch setting Master

CH1 output parallel

CH2 output separate

1CH with alarm

output mode



Calibration

off on

1	<input checked="" type="checkbox"/> <input type="checkbox"/>	.. 1 k Ω	} sensitivity
2	<input checked="" type="checkbox"/> <input type="checkbox"/>	.. 10 k Ω	
3	<input type="checkbox"/> <input checked="" type="checkbox"/>	.. 200 k Ω	
4	<input checked="" type="checkbox"/> <input type="checkbox"/>	Δ S (OFF)	
5	<input type="checkbox"/> <input checked="" type="checkbox"/>	CH1 (MAX/MIN)	
6	<input type="checkbox"/> <input checked="" type="checkbox"/>	CH2 (MAX/MIN)	
7	<input checked="" type="checkbox"/> <input type="checkbox"/>	Alarm (OFF)	
8	<input type="checkbox"/> <input checked="" type="checkbox"/>	Slave/Master (Master)	

Switch setting Slave

CH1 output parallel

CH2 output separate

1CH with alarm

output mode



Calibration

off on

1	<input checked="" type="checkbox"/> <input type="checkbox"/>	.. 1 k Ω	} sensitivity
2	<input checked="" type="checkbox"/> <input type="checkbox"/>	.. 10 k Ω	
3	<input type="checkbox"/> <input checked="" type="checkbox"/>	.. 200 k Ω	
4	<input checked="" type="checkbox"/> <input type="checkbox"/>	Δ S (OFF)	
5	<input type="checkbox"/> <input checked="" type="checkbox"/>	CH1 (MAX/MIN)	
6	<input type="checkbox"/> <input checked="" type="checkbox"/>	CH2 (MAX/MIN)	
7	<input checked="" type="checkbox"/> <input type="checkbox"/>	Alarm (OFF)	
8	<input checked="" type="checkbox"/> <input type="checkbox"/>	Slave/Master (Slave)	

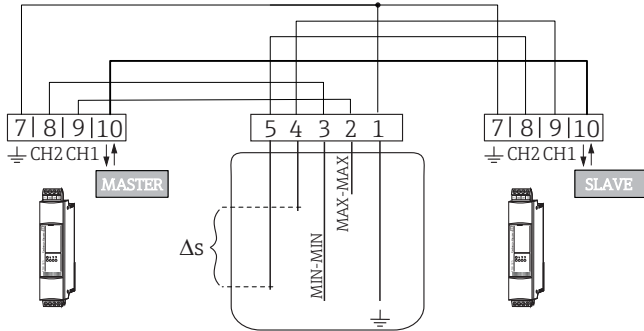

- de** – Zweipunktregelung (Δs) ohne Alarmüberwachung und Zweikanalbetrieb (Ausgänge separat)
- en** – Two-point control (Δs) without alarm signal and two channel mode (outputs separate)
- fr** – Régulation entre deux points (Δs) avec signal alarme et mode deux voies (sorties séparées)
- es** – Dos puntos de control (Δs) sin señal de alarma y dos canales (salidas separadas)
- it** – Controllo su due punti (Δs) senza segnale allarme e modalità a due canali (uscite separate)
- nl** – Twee-punts regeling (Δs) zonder functiealarm en tweekanaalsfunctie (uitgangen separaat)

Master

Output CH1

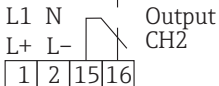
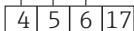

Power supply

Slave

Output Δs - Signal

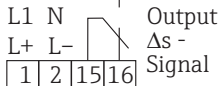
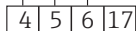

Power supply

de - Zweipunktregelung (Δs) ohne Alarmüberwachung und Zweikanalbetrieb (Ausgänge separat)

en - Two-point control (Δs) without alarm signal and two channel mode (outputs separate)

fr - Régulation entre deux points (Δs) avec signal alarme et mode deux voies (sorties séparées)

es - Dos puntos de control (Δs) sin señal de alarma y dos canales (salidas separadas)

it - Controllo su due punti (Δs) senza segnale allarme e modalità a due canali (uscite separate)

nl - Twee-punts regeling (Δs) zonder functiealarm en tweekanaalsfunctie (uitgangen separaat)

Switch setting Master

CH1 output parallel

CH2 output separate

1CH with alarm



output mode



Calibration

off on

1	<input checked="" type="checkbox"/> <input type="checkbox"/>	.. 1 k Ω	} sensitivity
2	<input checked="" type="checkbox"/> <input type="checkbox"/>	.. 10 k Ω	
3	<input type="checkbox"/> <input checked="" type="checkbox"/>	.. 200 k Ω	
4	<input checked="" type="checkbox"/> <input type="checkbox"/>	ΔS (OFF)	
5	<input checked="" type="checkbox"/> <input checked="" type="checkbox"/>	CH1 (MAX/MIN)	
6	<input checked="" type="checkbox"/> <input checked="" type="checkbox"/>	CH2 (MAX/MIN)	
7	<input checked="" type="checkbox"/> <input type="checkbox"/>	Alarm (OFF)	
8	<input type="checkbox"/> <input checked="" type="checkbox"/>	Slave/Master (Master)	

Switch setting Slave

CH1 output parallel

CH2 output separate

1CH with alarm



output mode



Calibration

off on

1	<input checked="" type="checkbox"/> <input type="checkbox"/>	.. 1 k Ω	} sensitivity
2	<input checked="" type="checkbox"/> <input type="checkbox"/>	.. 10 k Ω	
3	<input type="checkbox"/> <input checked="" type="checkbox"/>	.. 200 k Ω	
4	<input type="checkbox"/> <input checked="" type="checkbox"/>	ΔS (ON)	
5	<input checked="" type="checkbox"/> <input type="checkbox"/>	CH1 (MAX)	
6	<input checked="" type="checkbox"/> <input type="checkbox"/>	CH2 (MAX)	
7	<input checked="" type="checkbox"/> <input type="checkbox"/>	Alarm (OFF)	
8	<input checked="" type="checkbox"/> <input type="checkbox"/>	Slave/Master (Slave)	

Fehlfunktion	Ursache	Maßnahme
Schaltet nicht	Versorgungsspannung fehlt (Grüne Leuchtdiode aus)	Versorgung prüfen
	Elektronik defekt	FTW325 austauschen
	Kontakte verschweißt (nach einem Kurzschluss)	FTW325 austauschen; Sicherung in den Kontaktstromkreis
	Messaufnehmer defekt	Messaufnehmer austauschen
Schaltet falsch	Im FTW325 Umschalter für Grenzsignal falsch eingestellt	Umschalter hinter der Frontplatte richtig einstellen
Dauernde Störungsmeldung	Unterbrechung oder Kurzschluss der Leitung zum Messaufnehmer	Leitung überprüfen
	Messaufnehmer-Elektronik defekt	Messaufnehmer-Elektronik austauschen
	Nivotester defekt	FTW325 austauschen

en - Trouble-shooting

Fault	Reason	Remedy
Does not switch	No power (green LED does not light up)	Check power
	Electronic defect	Replace FTW325
	Contacts welded together (after short-circuit)	Replace FTW325; connect a fuse into contactor circuit
	Measuring transmitter defective	Replace measuring transmitter
Switches incorrectly	Incorrect setting of change-over switch for limit signal in FTW325	Correctly set change-over switch behind front panel
Permanent alarm signal	Interrupt or short-circuit line to measuring transmitter	Check line
	Measuring transmitter electronics defective	Replace measuring transmitter electronics
	Nivotester defective	Replace FTW325

Défaut	Cause	Mesure
Ne commute pas	Absence tension d'alimentation (diode verte éteinte)	Vérifier l'alimentation
	Electronique défectueuse	Remplacer le FTW325
	Contacts soudés (après un court-circuit)	Remplacer le FTW325; insérer un fusible dans le circuit du contact
	Capteur défectueux	Remplacer le capteur
Mauvaise commutation	Dans le FTW325, commutateur pour signal de seuil mal réglé	Régler correctement le commutateur derrière la plaque frontale
Message alarme permanent	Interruption ou court-circuit de la liaison au capteur	Vérifier la liaison
	Electronique du capteur défectueuse	Remplacer l'électronique du capteur
	Nivotester défectueux	Remplacer le FTW325

es - Identificación de fallos

Fallo	Causa	Solución
No conmuta	No hay alimentación (el LED verde no está iluminado)	Compruebe la alimentación
	Las electrónicas son defectuosas	Sustituya el FTW325
	Contactos soldados juntos (después del corto circuito)	Sustituya el FTW325; conecte un fusible en el circuito contactor
	Sensor defectuoso	Sustituya el sensor
Conmuta incorrectamente	Ajuste incorrecto de la señal de límite en FTW325	Posicione correctamente el interruptor en el frontal
Aviso de fallo constante	Interrupción o cortocircuito de la conexión con el sensor	Compruebe el cableado
	Electrónicas del transmisor defectuosas	Cambie la electrónica del transmisor
	Nivotester defectuoso	Sustituya el FTW325

**it - Individuazione e
eliminazione delle anomalie**

Guasto	Motivo	Rimedio
Non commuta	Mancanza alimentazione (LED verde spento)	Controllare l'alimentazione
	Elettronica guasta	Sostituire elettronica FTW325
	Contatti saldati insieme (dopo il corto circuito)	Sostituire FTW325; mettere il fusibile nel circuito di contatto
	Trasmettitore di misura difettoso	Sostituire trasmettitore di misura
Commuta non correttamente	Settaggio FTW325 non corretto	Correggere il punto di misura
Segnali di allarme permanente	Interruzione del collegamento al trasmettitore	Verifica la linea
	Trasmettitore di misura elettronica difettosa	Sostituire trasmettitore di misura elettronica
	Nivotester guasto	Sostituire il FTW325



nl - Fout zoeken



Fout	Oorzaak	Maatregel
Schakelt niet	Voeding ontbreekt (groene LED = uit)	Voeding controleren
	Elektronica defect	FTW325 wisselen
	Contacten verkleefd (na kortsluiting)	FTW325 wisselen; zekering in schakelkring opnemen
	Sensor defect	Sensor wisselen
Schakelt foutief	In de FTW325 niveausignaal fout ingesteld	Omschakelaar achter de frontplaat goed instellen
Continu stooralarm	Onderbreking of kortsluiting van sensor leiding	Leiding controleren
	Sensor elektronica defect	Sensor elektronica wisselen
	Nivotester defect	FTW325 wisselen

Technische Information / Technical Information / Information technique /
Información técnica / Informazioni tecniche / Technische Informatie

TI00373F

Sicherheitshinweise / Notes on Safety / Conseils de sécurité /
Notas sobre seguridad / Note sulla sicurezza / Veiligheidsinstructies

XA00196F   II (1) G [Ex ia Ga] IIC/IIB

  II (1) D [Ex ia Da] IIIC

**de - Ergänzende
Dokumentation**

**en - Supplementary
Documentation**

**fr - Documentation
complémentaire**

**es - Documentación
adicional**

**it - Documentazione
supplementare**

**nl - Aanvullende
documentatie**

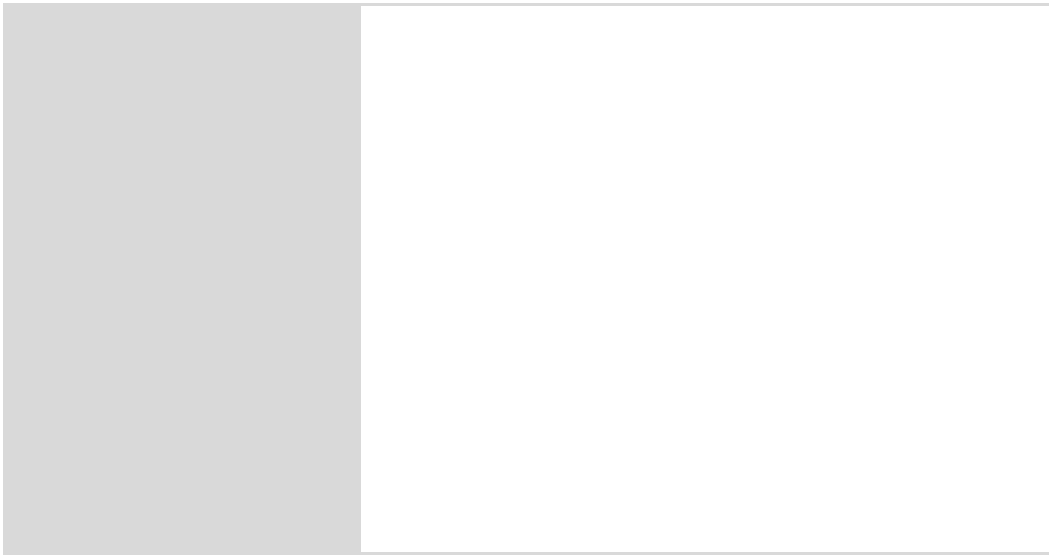

www.endress.com/worldwide

