



Level



Pressure



Flow



Temperature



Liquid
Analysis



Registration



Systems
Components



Services



Solutions

Brief Operating Instructions

Cerabar S

PMC71, PMP71, PMP75

Process pressure measurement

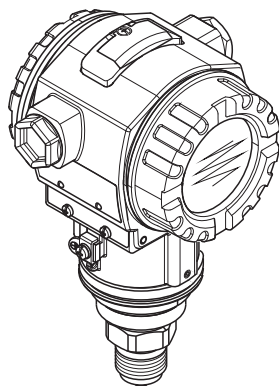

These Instructions are Brief Operating Instructions; they are not a substitute for the Operating Instructions pertaining to the device.

Detailed information about the device can be found in the Operating Instructions and the other documentation:

Available for all device versions via:

- Internet: www.endress.com/deviceviewer
- Smart phone/tablet: *Endress+Hauser Operations App*

KA01025P/00/EN/16.14
71270355

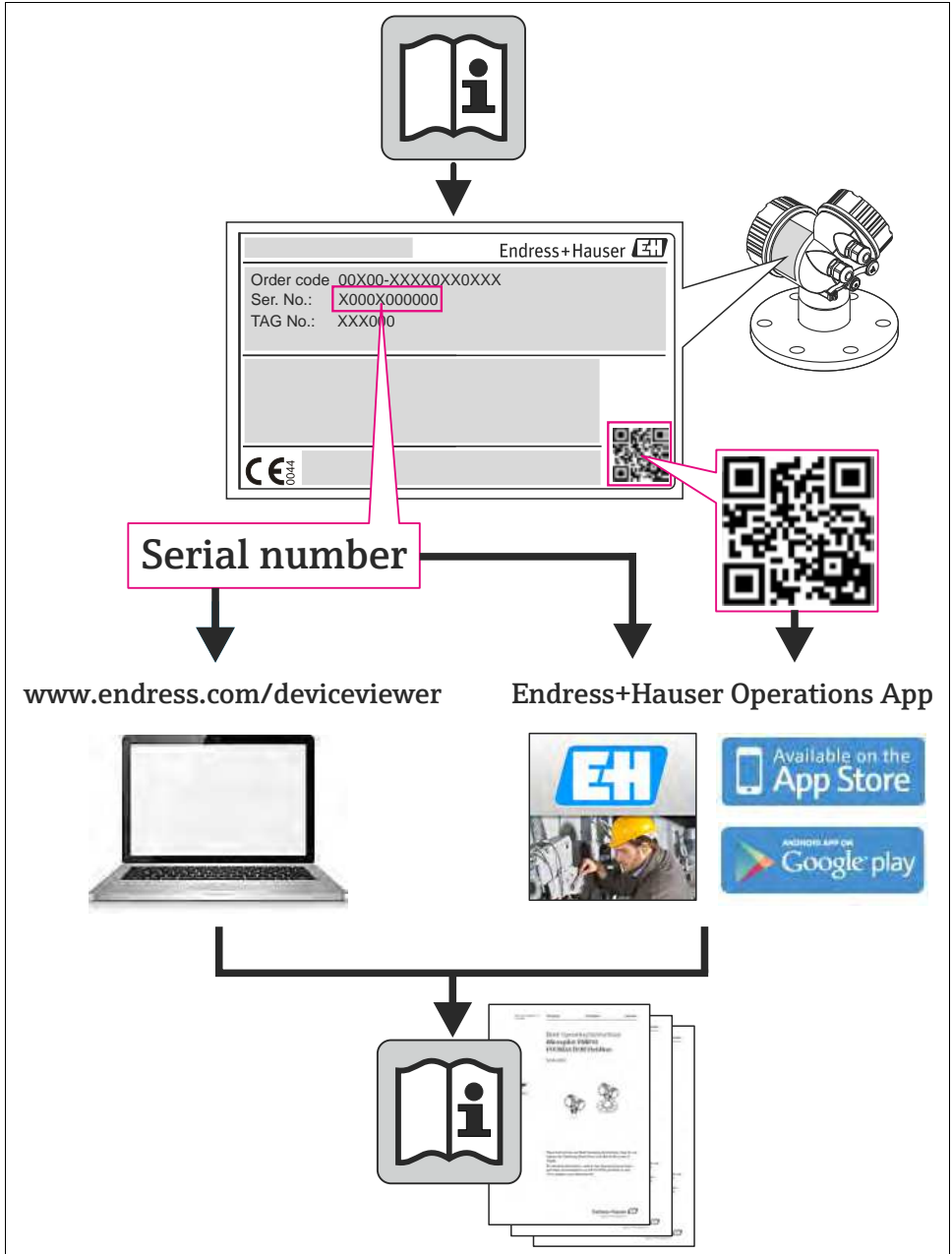

A0023555

Table of contents

1	Safety instructions	4
1.1	Designated use	4
1.2	Installation, commissioning and operation	4
1.3	Operational safety and process safety	4
1.4	Return	4
1.5	Safety icons	5
2	Product identification	5
3	Installation	5
3.1	General installation instructions	5
3.2	Installation instructions for devices without diaphragm seals PMP71, PMC71	6
3.3	Installation instructions for devices with diaphragm seals PMP75	8
3.4	Assembling and mounting the "separate housing" version	10
4	Wiring	11
4.1	Connecting the device	11
4.2	Connecting the measuring unit	12
5	Operation	14
5.1	Onsite display (optional)	14
5.2	Operating elements	16
5.3	Onsite operation via onsite display	18
5.4	Locking/unlocking operation	22
6	Commissioning	23
6.1	Commissioning via an FF configuration program	23
6.2	Selecting the language and measuring mode	25
6.3	Position adjustment	26
6.4	Pressure measurement	28
6.5	Level measurement	30
6.6	Scaling the OUT parameter	35

1 Safety instructions

1.1 Designated use

The Cerabar S is a pressure transmitter for measuring pressure and level.

The manufacturer accepts no liability for damages resulting from incorrect use or use other than that designated.

1.2 Installation, commissioning and operation

- The device must only be installed, connected, commissioned and maintained by qualified and authorized specialists (e.g. electrical technicians) in full compliance with the instructions in this manual, the applicable norms, legal regulations and certificates (depending on the application).
- The specialist must have read and understood this manual and must follow the instructions it contains. If you are unclear on anything in these Brief Operating Instructions, you must read the Operating Instructions. The Operating Instructions provide detailed information on the device/measuring system.
- The device may only be modified or repaired if such work is expressly permitted in the Operating Instructions.
- If faults cannot be rectified, the device must be taken out of service and secured against unintentional commissioning.
- Do not operate damaged devices. Mark them as defective.



1.3 Operational safety and process safety

- Alternative monitoring measures must be taken to ensure operational safety and process safety during configuration, testing and maintenance work on the device.
- The device is safely built and tested according to state-of-the-art technology and has left the factory in perfect condition as regards technical safety. The applicable regulations and European standards have been taken into account.
- Pay particular attention to the technical data on the nameplate.
- Devices for use in hazardous areas are fitted with an additional nameplate. If the device is to be installed in an explosion hazardous area, then the specifications in the certificate as well as all national and local regulations must be observed. The device is accompanied by separate "Ex documentation", which is an integral part of this Operating Instructions. The installation regulations, connection values and Safety Instructions listed in this Ex document must be observed. The documentation number of the related Safety Instructions is also indicated on the additional nameplate.

1.4 Return

Follow the instructions on returning the device as outlined in the Operating Instructions.

1.5 Safety icons

Symbol	Meaning
	Warning! A warning highlights actions or procedures which, if not performed correctly, will lead to personal injury, a safety hazard or destruction of the instrument.
	Caution! Caution highlights actions or procedures which, if not performed correctly, may lead to personal injury or incorrect functioning of the instrument.
	Note! A note highlights actions or procedures which, if not performed correctly, may indirectly affect operation or may lead to an instrument response which is not planned.

2 Product identification

The following options are available for identification of the measuring device:

- Nameplate specifications
- Order code with breakdown of the device features on the delivery note
- Enter serial numbers from nameplates in W@M Device Viewer (www.endress.com/deviceviewer): All information about the measuring device is displayed.

For an overview of the technical documentation provided, enter the serial number from the nameplates in the W@M Device Viewer (www.endress.com/deviceviewer).

3 Installation

3.1 General installation instructions



Warning!

The process seal is not allowed to press on the process isolating diaphragm as this could affect the measurement result.

**Note!**

- If a heated Cerabar S is cooled during the cleaning (e.g. by cold water), a vacuum develops for a short time, whereby water can penetrate the sensor through the pressure compensation (1). If this is the case, mount the sensor with the pressure compensation (1) pointing downwards.

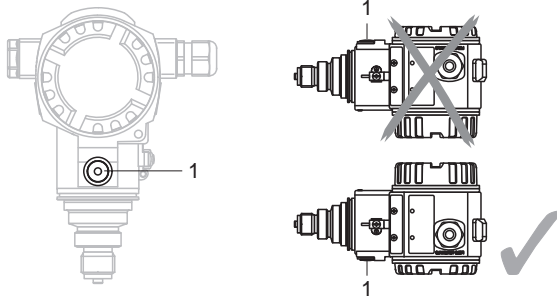

- Keep the pressure compensation and GORE-TEX® filter (1) free from contaminations.
- Do not clean or touch process isolating diaphragm of the diaphragm seals with hard or pointed objects.
- Due to the orientation of the Cerabar S, there may be a shift in the measured value, i.e. when the container is empty, the measured value does not display zero. You can correct this zero point shift either via the "zero" key on the electronic insert, or on the outside of the device or via the onsite display. → § 16, Section 5.2.1 "Position of operating elements", → § 17, Section 5.2.2 "Function of the operating elements – onsite display not connected" and → § 26, Section 6.3 "Position adjustment".
- For PMP75, please refer to Section 2.3 "Installation instructions for devices with diaphragm seals", → § 8.
- The PMC71 High temperature version and the PMP75 must only be insulated up to a certain height.
- To ensure optimal readability of the onsite display, it is possible to rotate the housing up to 380°.
- The onsite display can be rotated in 90° stages.
- Endress+Hauser offers a mounting bracket for installing on pipes or walls.

3.2 Installation instructions for devices without diaphragm seals PMP71, PMC71

Cerabar S without diaphragm seal are mounted as per the norms for a manometer (DIN EN 837-2). We recommend the use of shutoff devices and siphons. The orientation depends on the measuring application.

3.2.1 Pressure measurement

Pressure measurement in gases

- Mount Cerabar S with shutoff device above the tapping point so that the condensate can flow into the process.

Pressure measurement in steams

- Mount Cerabar S with siphon below the tapping point.
The siphon reduces the temperature to almost ambient temperature.
- Fill the siphon with fluid before commissioning.

Pressure measurement in liquids

- Mount Cerabar S with shutoff device below or at the same level as the tapping point.

3.2.2 Level measurement

- Mount Cerabar S below the lowest measuring point.
- Do not mount the device at the following positions:
In the fill flow, in the tank outlet or at a point in the container which could be affected by pressure pulses from an agitator.
- The calibration and functional test can be carried out more easily if you mount the device after a shutoff device.

3.3 Installation instructions for devices with diaphragm seals PMP75



Note!

- The diaphragm seal, together with the pressure transmitter, forms a closed, calibrated system, which is filled through openings in the diaphragm seal and in the measurement system of the pressure transmitter. The openings are sealed and must not be opened.
- Do not remove the protection of the process isolating diaphragm until shortly before installation.
- When using a mounting bracket, sufficient strain relief must be ensured for the capillaries in order to prevent the capillary bending down (bending radius ≥ 100 mm).
- Please note that the hydrostatic pressure of the liquid column in the capillary can cause zero point shift. You can correct this zero point shift either via the "zero" key on the electronic insert, or on the outside of the device or via the onsite display. → 16, Section 5.2.1 "Position of operating elements", → 17, Section 5.2.2 "Function of the operating elements – onsite display not connected" and → 26, Section 6.3 "Position adjustment".
- Please note the application limits of the diaphragm seal filling oil as detailed in the Technical Information for TI00383P, Section "Planning instructions for diaphragm seal systems" or at "www.endress.com/applicator".

In order to obtain more precise measurement results and to avoid a defect in the device, mount the capillaries as follows:

- vibration-free (in order to avoid additional pressure fluctuations)
- not in the vicinity of heating or cooling lines
- insulate if the ambient temperature is below or above the reference temperature
- with a bending radius of ≥ 100 mm.

3.3.1 Vacuum application

For applications under vacuum, Endress+Hauser recommends mounting the pressure transmitter underneath the diaphragm seal. A vacuum load of the diaphragm seal caused by the presence of filling oil in the capillary is hereby prevented.

When the pressure transmitter is mounted above the diaphragm seal, the maximum height difference H_1 in accordance with the illustration below on the left must not be exceeded. The maximum height difference is dependent on the density of the filling oil and the smallest ever pressure that is permitted to occur at the diaphragm seal (empty container), see illustration below, on the right.

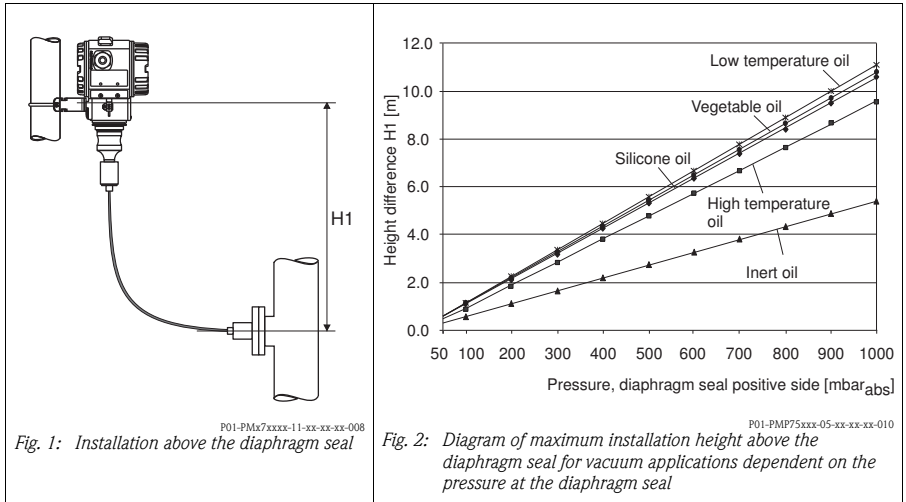

3.4 Assembling and mounting the "separate housing" version

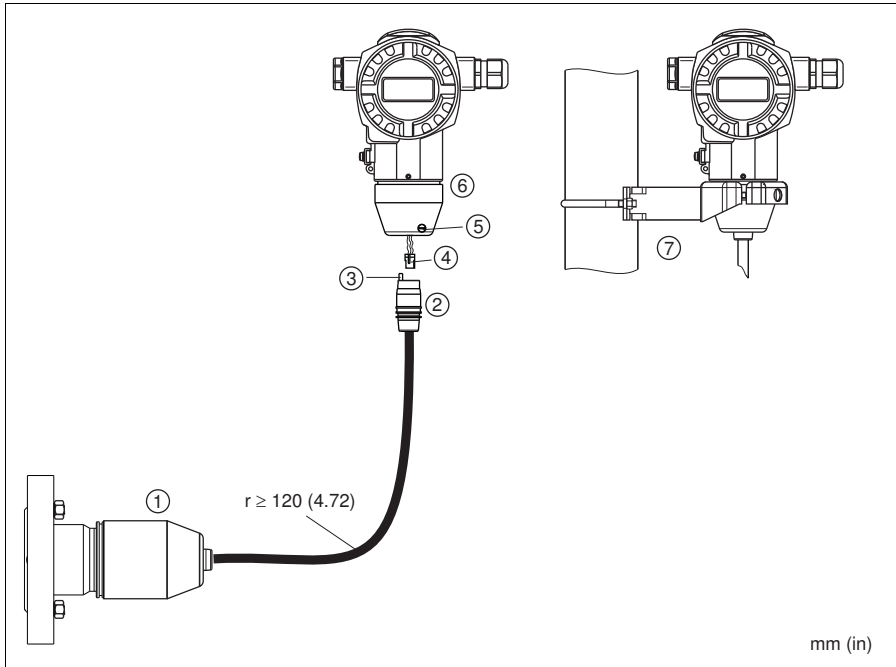

P01-PMx7xxxx-11-xx-xx-xx-011

Fig. 3: "Separate housing" version

- 1 In the "separate housing" version, the sensor is supplied with process connection and cable fitted.
- 2 Cable with connection jack
- 3 Pressure compensation
- 4 Plug
- 5 Locking screw
- 6 Housing fitted with housing adapter, included
- 7 Mounting bracket suitable for wall and pipe mounting, included

Assembly and mounting

1. Connect plug (item 4) into the corresponding connection jack of the cable (item 2).
2. Plug the cable into the housing adapter (item 6).
3. Tighten the locking screw (item 5).
4. Mount the housing on a wall or pipe using the mounting bracket (item 7).
When mounting on a pipe, tighten the nuts on the bracket uniformly with a torque of at least 5 Nm.
Mount the cable with a bending radius (r) ≥ 120 mm.

4 Wiring

4.1 Connecting the device



Warning!

Risk of electric shock!

If the operating voltage is > 35 VDC: Dangerous contact voltage at terminals.
In a wet environment, do not open the cover if voltage is present.



Warning!

Limitation of electrical safety due to incorrect connection!

- Risk of electric shock and/or explosion in hazardous areas! In a wet environment, do not open the cover if voltage is present.
- When using the measuring device in hazardous areas, installation must comply with the corresponding national standards and regulations and the Safety Instructions or Installation or Control Drawings.
- Devices with integrated overvoltage protection must be earthed.
- Protective circuits against reverse polarity, HF influences and overvoltage peaks are installed.
- The supply voltage must match the supply voltage on the nameplate.
- Switch off the supply voltage before connecting the device.
- Remove housing cover of the terminal compartment.
- Guide cable through the gland. Preferably use twisted, screened two-wire cable.
- Connect device in accordance with the following diagram.
- Screw down housing cover.
- Switch on supply voltage.

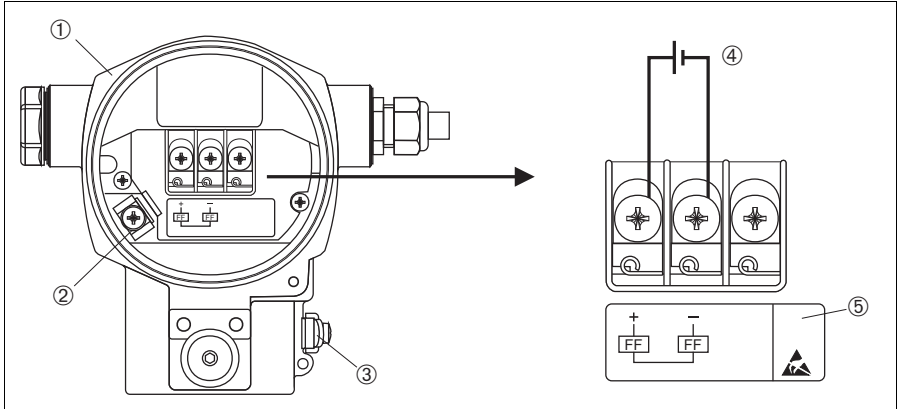

P01-2Mx7xxxx-04-xx-xx-xx-009

Fig. 4: Electrical connection FOUNDATION Fieldbus, observe also the following section.
For devices with 7/8" plug see Operating Instructions.

- 1 Housing
- 2 Internal ground terminal
- 3 External ground terminal
- 4 Supply voltage, for version in non-hazardous area = 9 to 32 V DC
- 5 Devices with integrated overvoltage protection are labeled OVP (overvoltage protection) here.

4.2 Connecting the measuring unit



Note!

For further information on the network structure and grounding and for further bus system components such as bus cables, see the relevant documentation, e.g. Operating Instructions BA00013S "FOUNDATION Fieldbus Overview" and the FOUNDATION Fieldbus Guideline.

4.2.1 Supply voltage

- Version for non-hazardous area: 9 to 32 V DC

4.2.2 Current consumption

15.5 mA \pm 1 mA, switch-on current corresponds to IEC 61158-2, Clause 21.

4.2.3 Cable specification

- Use a twisted, shielded two-wire cable, preferably cable type A
- Terminals for wire cross-sections: 0.5 to 2.5 mm²
- Outer cable diameter: 5 to 9 mm



Note!

For further information on the cable specifications, see Operating Instructions BA00013S "FOUNDATION Fieldbus Overview", FOUNDATION Fieldbus Guideline and IEC 61158-2 (MBP).

4.2.4 Grounding and shielding

Cerabar S must be grounded, for example by means of the external ground terminal.

Different grounding and shielding installation methods are available for FOUNDATION Fieldbus networks such as:

- Isolated installation (see also IEC 61158-2)
- Installation with multiple grounding
- Capacitive installation

5 Operation

5.1 Onsite display (optional)

A 4-line liquid crystal display (LCD) is used for display and operation. The onsite display shows measured values, dialog texts, fault messages and notice messages.

The display of the device can be turned in 90° steps.





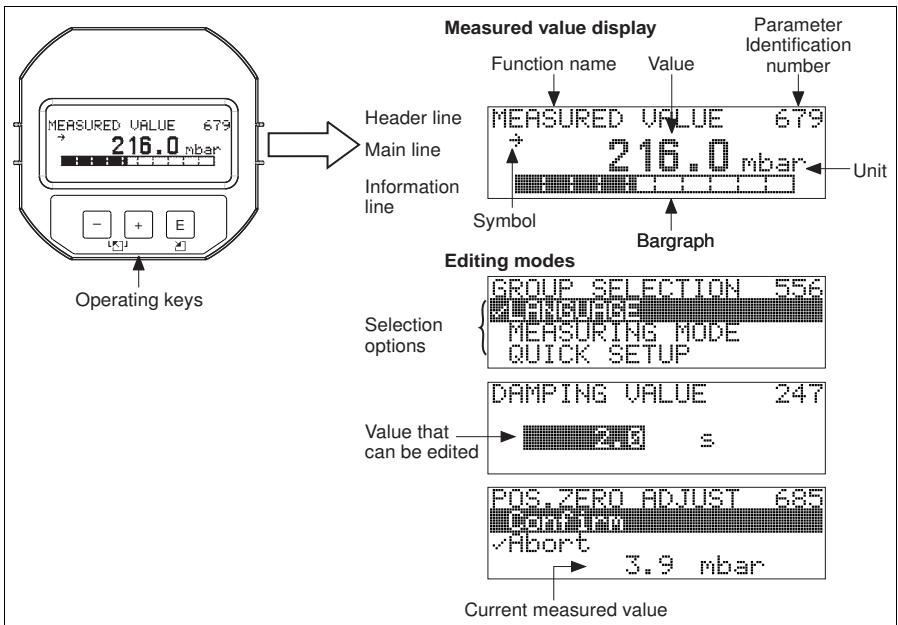



Depending on the installation position of the device, this makes it easy to operate the device and read the measured values.

The onsite display is available in English. Needless to say, the device can also be operated in 6 languages (de, en, fr, es, jp, ch) via the DTM or EDD. The FieldCare program is an E+H DTM operating tool and can be acquired from endress.com.



P01-xxxxxxx-07-xx-xx-xx-011

The following table illustrates the symbols that can appear on the onsite display. Four symbols can occur at one time.

Symbol	Meaning
	Alarm symbol – Symbol flashing: warning, device continues measuring. – Symbol permanently lit: error, device does not continue measuring. <i>Note:</i> The alarm symbol may overlie the tendency symbol.
	Lock symbol The operation of the device is locked. Unlock device, →  22, Section 5.4.
	Communication symbol Data transfer via communication
	Simulation symbol Simulation mode is activated. DIP switch 2 for simulation is set to "On". →  16, Section 5.2.1 "Position of operating elements".
	Tendency symbol (increasing) The primary value of the Transducer Block is increasing.
	Tendency symbol (decreasing) The primary value of the Transducer Block is decreasing.
	Tendency symbol (constant) The primary value of the Transducer Block has remained constant over the past few minutes.

5.2 Operating elements

5.2.1 Position of operating elements

With regard to aluminum housings and stainless steel housing (T14/T15), the operating key is located either outside the device under the protection cap or inside on the electronic insert. In hygienic stainless housings (T17), the operating key is always located inside on the electronic insert. Additionally, three operating keys are located on the optional onsite display.

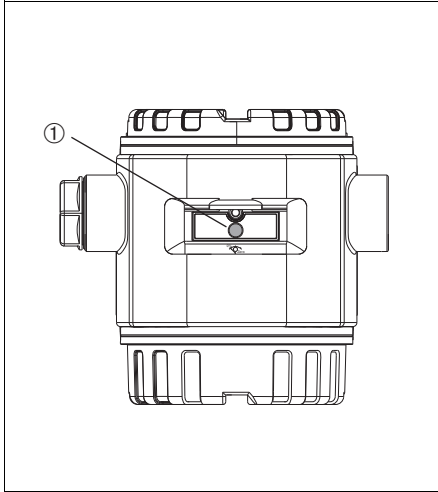

P01-PMx7xxxx-19-xx-xx-xx-075

Fig. 5: Operating key, external under the protective flap

- 1 Operating key or position adjustment (zero point-correction) or total reset

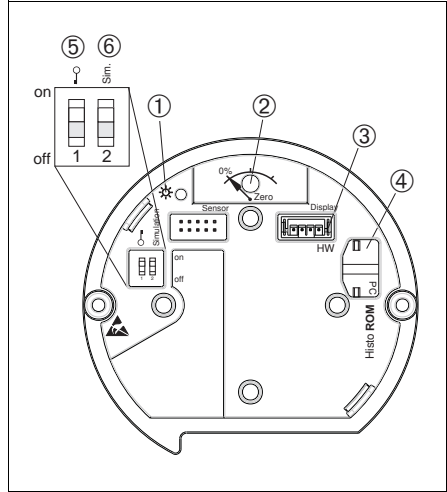

P01-xxxxxxx-19-xx-xx-xx-106



Fig. 6: Operating key and operating elements, internal

- 1 Green LED to indicate value is accepted
- 2 Operating key for position adjustment (zero point-correction)
- 3 Slot for optional display
- 4 Slot for optional HistoROM® /M-DAT
- 5 DIP-switch for locking/unlocking measured-value-relevant parameters
- 6 DIP switch for simulation mode

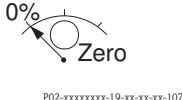
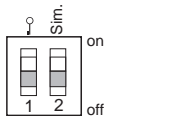
5.2.2 Function of the operating elements – onsite display not connected

Operating key(s)	Meaning
	<ul style="list-style-type: none"> - Position adjustment (zero point correction): Press key for at least 3 seconds. The LED on the electronic insert lights up briefly if the pressure applied has been accepted for position adjustment. → 33 ("Level" measuring mode) or → 28 ("Pressure" measuring mode). - Total reset: Press key for at least 12 seconds. If the LED on the electronic insert lights up briefly, the reset is being carried out.
	<ul style="list-style-type: none"> - DIP-switch 1: for locking/unlocking measured-value-relevant parameters Factory setting: off (unlocked) - DIP switch 2: for simulation mode Factory setting: off (simulation mode off) To carry out a simulation the DIP switch has to be set in the "on" position. → See also Operating Instructions BA00302P, Section "Simulation".

5.2.3 Function of the operating elements – onsite display connected

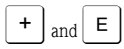
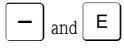
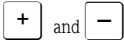
Operating key(s)	Meaning
	<ul style="list-style-type: none"> - Navigate upwards in the picklist - Edit the numerical values and characters within a function
	<ul style="list-style-type: none"> - Navigate downwards in the picklist - Edit the numerical values and characters within a function
	<ul style="list-style-type: none"> - Confirm entry - Jump to the next item
	<p>Contrast setting of onsite display: darker</p>
	<p>Contrast setting of onsite display: brighter</p>
	<p>ESC functions:</p> <ul style="list-style-type: none"> - Exit edit mode without saving the changed value. - You are in a menu within a function group. The first time you press the keys simultaneously, you go back a parameter within the function group. Each time you press the keys simultaneously after that, you go up a level in the menu. - You are in a menu at a selection level. Each time you press the keys simultaneously, you go up a level in the menu. <p><i>Note:</i> The terms function group, level and selection level are explained in → 18, Section 5.3.1.</p>

5.3 Onsite operation via onsite display

5.3.1 Structure of the operating menu

The menu is split into four levels. The three upper levels are used to navigate while you use the bottom level to enter numerical values, select options and save settings. → For the entire menu see CD-ROM, Operating Instructions BA00302P.

The structure of the OPERATING MENU depends on the measuring mode selected, e.g. if the "Pressure" measuring mode is selected, only the functions necessary for this mode are displayed.

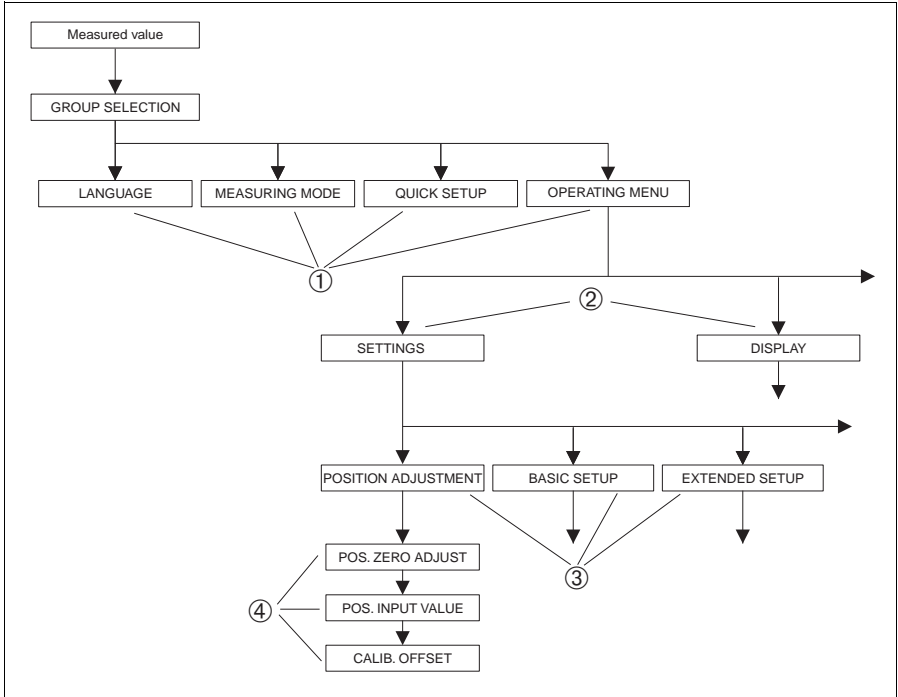

P01-xxxxxxxx-19-xx-xx-xx-145

Fig. 7: Structure of the operating menu

- 1 1. Selection level
- 2 2. Selection level
- 3 Function groups
- 4 Parameter

5.3.2 Selecting an option

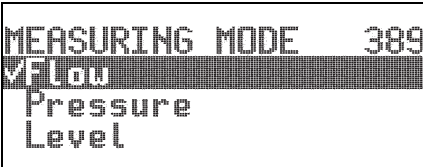
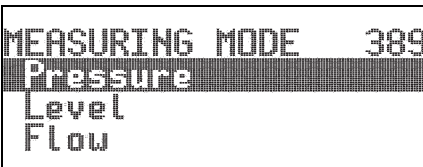
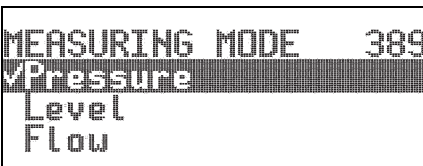

Example: Selecting the "Pressure" measuring mode.

Onsite display	Operation
 <p style="text-align: right; font-size: small;">P01-xxxxxxxx-19-xx-xx-en-017</p>	<p>"Level" has been selected as the measuring mode. A ✓ in front of the menu text indicates the active option.</p>
 <p style="text-align: right; font-size: small;">P01-xxxxxxxx-19-xx-xx-en-033</p>	<p>Use "+" or "-" to select "Pressure" as the operating mode.</p>
 <p style="text-align: right; font-size: small;">P01-xxxxxxxx-19-xx-xx-en-034</p>	<ol style="list-style-type: none"> 1. Confirm your choice with "E". A ✓ in front of the menu text indicates the active option. (The "Pressure" measuring mode is selected.) 2. Jump to the next item with "E".

5.3.3 Editing a value

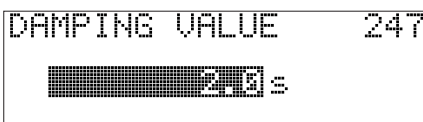
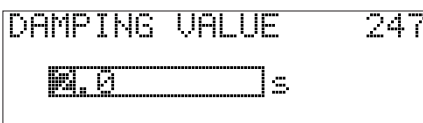

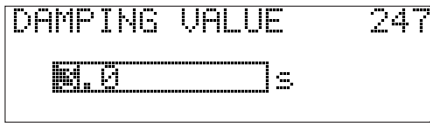
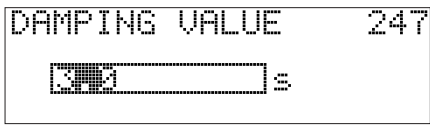
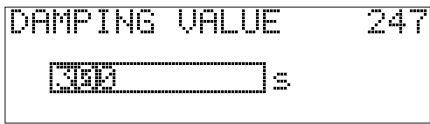
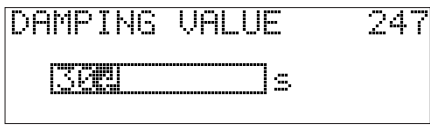

Example: adjusting DAMPING VALUE function from 2.0 s to 30.0 s. → 17, Section 5.2.3 "Function of the operating elements – onsite display connected".

Onsite display	Operation
 <p style="text-align: right; font-size: small;">P01-xxxxxxxx-19-xx-xx-en-023</p>	<p>The onsite display shows the parameter to be changed. The value highlighted in black can be changed. The "s" unit is fixed and cannot be changed.</p>
 <p style="text-align: right; font-size: small;">P01-xxxxxxxx-19-xx-xx-en-027</p>	<ol style="list-style-type: none"> 1. Press "+" or "-" to get to the editing mode. 2. The first digit is highlighted in black.

Onsite display	Operation
 <p style="text-align: right; font-size: small;">P01-xxxxxxx-19-xx-xx-xx-028</p>	<ol style="list-style-type: none"> 1. Use "+" to change "2" to "3". 2. Confirm "3" with "E". The cursor jumps to the next position (highlighted in black).
 <p style="text-align: right; font-size: small;">P01-xxxxxxx-19-xx-xx-xx-029</p>	<p>The decimal point is highlighted in black, i.e. you can now edit it.</p>
 <p style="text-align: right; font-size: small;">P01-xxxxxxx-19-xx-xx-xx-030</p>	<ol style="list-style-type: none"> 1. Keep pressing "+" or "-" until "0" is displayed. 2. Confirm "0" with "E". The cursor jumps to the next position. ▾ is displayed and is highlighted in black. → See next graphic.
 <p style="text-align: right; font-size: small;">P01-xxxxxxx-19-xx-xx-xx-031</p>	<p>Use "E" to save the new value and exit the editing mode. → See next graphic.</p>
 <p style="text-align: right; font-size: small;">P01-xxxxxxx-19-xx-xx-xx-032</p>	<p>The new value for the damping is now 30.0 s.</p> <ul style="list-style-type: none"> - Jump to the next parameter with "E". - You can get back to the editing mode with "+" or "-".

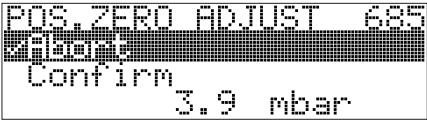
5.3.4 Taking pressure applied at device as value

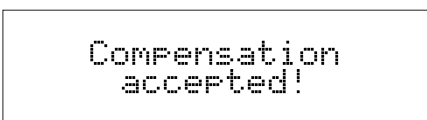
Example: performing position adjustment.

Onsite display	Operation
 <p style="text-align: center; font-size: small;">P01-xxxxxxxx-19-xx-xx-xx-158</p>	<p>The bottom line on the onsite display displays the pressure present, here 3.9 mbar.</p>
 <p style="text-align: center; font-size: small;">P01-xxxxxxxx-19-xx-xx-xx-159</p>	<p>Use "+" or "-" to switch to the "Confirm" option. The active selection is highlighted in black.</p>
 <p style="text-align: center; font-size: small;">P01-xxxxxxxx-19-xx-xx-xx-037</p>	<p>Use "E" to assign the value (3.9 mbar) to the POS. ZERO ADJUST parameter. The device confirms the calibration and jumps back to the parameter, here POS. ZERO ADJUST (see next graphic).</p>
 <p style="text-align: center; font-size: small;">P01-xxxxxxxx-19-xx-xx-xx-160</p>	<p>Switch to the next parameter with "E".</p>

5.4 Locking/unlocking operation

Once you have entered all the parameters, you can lock your entries against unauthorized and undesired access.

You have the following possibilities for locking/unlocking the operation:

- Via a DIP switch on the electronic insert, locally at the device (→  16).
- Via the onsite display (optional)
- Via digital communication.

The -symbol on the onsite display indicates that operation is locked. Parameters which refer to how the display appears, e.g. DISPLAY CONTRAST can still be altered.



Note!

- If operation is locked by means of the DIP-switch, you can only unlock operation again by means of the DIP-switch. If operation is locked by means of remote operation e.g. FieldCare, you can only unlock operation again by means of remote operation.

The table provides an overview of the locking functions:

Locking via	View/read parameter	Modify/write via ¹⁾		Unlocking via		
		Onsite display	Remote operation	DIP-Switch	Onsite display	Remote operation
DIP-Switch	yes	no	no	yes	no	no
Onsite display	yes	no	no	no	yes	yes
Remote operation	yes	no	no	no	yes	yes

1) Parameters which refer to how the display appears, e.g. DISPLAY CONTRAST can still be altered.

	Locking/Unlocking operation via onsite display or remote operation
Locking operation	<ol style="list-style-type: none"> 1. Operation via FF configuration program: select SWLOCK parameter in the Resource Block. Operation via FieldCare: select INSERT PIN No. parameter. Menu path: OPERATING MENU → OPERATION → INSERT PIN No. 2. To lock operation, enter "0" for the parameter.
Unlocking operation	<ol style="list-style-type: none"> 1. Operation via FF configuration program: select SWLOCK parameter in the Resource Block. Operation via FieldCare: select INSERT PIN No. parameter. 2. To unlock operation, enter "100" for the parameter.

6 Commissioning



Warning!

- If a pressure that is lower than the minimum permitted pressure is present at the device, messages "E120 sensor low pressure" and "E727 sensor pressure error - overrange" are output in succession.
- If a pressure that is greater than the maximum permitted pressure is present at the device, messages "E115 sensor overpressure" and "E727 sensor pressure error - overrange" are output in succession.
- The messages E727, E115 and E120 are "Error"-type messages and can be configured as a "Warning" or an "Alarm". The factory setting for these messages is "Warning". This setting prevents the BAD status from being transmitted in applications (e.g. cascade measurement) where the user is aware of the risk of the sensor range being overshoot.
- We recommend setting messages E727, E115 and E120 to "Alarm" in the following instances:
 - It is not necessary to violate the sensor range for the measuring application.
 - A position adjustment must be carried out that has to correct a large measured error as a result of the orientation of the device.

6.1 Commissioning via an FF configuration program



Note!

- The device is configured for the Pressure measuring mode as standard. The measuring range and the unit in which the measured value is transmitted, as well as the digital output value of the Analog Input Block OUT, correspond to the data on the nameplate. Following a reset with code 7864, the OUT parameter may have to be rescaled (see also →  35, Section 6.6 "Scaling the OUT parameter").
1. Switch on the device.
 2. Note the DEVICE_ID.
 3. Open the configuration program.
 4. Load Cff and device description files into the host system or the configuration program. Make sure you are using the right system files.
 5. Identify the device using the DEVICE_ID. Assign the desired tag name to the device by means of the PD_TAG parameter.

Configuring the Resource Block

1. Open the Resource Block.
2. If necessary, disable the lock for device operation. See →  22, Section 5.4 "Locking/unlocking operation". Operating is unlocked as standard.
3. If necessary, change the block name. Factory setting: RS_452B481007-xxxxxxxxxxxx
4. If necessary, assign a description to the block by means of the TAG_DESC parameter.
5. If necessary, change other parameters as per the requirements.

Configuring the Transducer Blocks

Cerabar S has the following Transducer Blocks:

- Pressure Transducer Block
- Service Transducer Block
- Display Transducer Block
- Diagnostic Transducer Block

The explanation that follows is an example for the Pressure Transducer Block.

1. If necessary, change the block name. Factory setting: RS_452B481007-xxxxxxxxxxxx
2. Set the block mode to OOS using the MODE_BLK parameter, TARGET element.
3. Configure the device in accordance with the measuring task. → See also these Brief Operating Instructions Section 6.2 to Section 6.6.
4. Set the block mode to Auto using the MODE_BLK parameter, TARGET element.



Note!

The block mode must be set to "Auto" for the Pressure and Service Transducer Block for the measuring device to function correctly.

Configuring the Analog Input Blocks

Deltapilot S has 2 Analog Input Blocks that can be assigned as required to the various process variables.

1. If necessary, change the block name. Factory setting: RS_452B481007-xxxxxxxxxxxx
2. Set the block mode to OOS using the MODE_BLK parameter, TARGET element.
3. Use the CHANNEL parameter to select the process variable which should be used as the input value for the Analog Input Block. The following settings are possible:
 - CHANNEL = 1: Primary value, a pressure or level value depending on the measuring mode selected
 - CHANNEL = 2: Secondary value, here the sensor temperature
 Factory setting:
 - Analog Input Block 1: CHANNEL = 1: Primary Value (pressure measured value)
 - Analog Input Block 2: CHANNEL = 2: Secondary Value (sensor temperature)

4. Use the XD_SCALE parameter to select the desired unit and the block input range for the process variable. See also →  35, Section 6.6 "Scaling the OUT parameter".
Make sure that the unit selected suits the process variable selected. If the process variable does not suit the unit, the BLOCK_ERROR parameter reports "Block Configuration Error" and the block mode cannot be set to "Auto".
5. Use the L_TYPE parameter to select the type of linearization for the input variable (factory setting: Direct).
Make sure that the settings for the XD_SCALE and OUT_SCALE parameters are the same for the "Direct" linearization type. If the process values and units do not match, the BLOCK_ERROR parameter reports "Block Configuration Error" and the block mode cannot be set to "Auto".
6. Enter the alarm and critical alarm messages by means of the HI_HI_LIM, HI_LIM, LO_LO_LIM and LO_LO_LIM parameters. The limit values entered have to be within the value range specified for the OUT_SCALE parameter.
7. Specify the alarm priorities by means of the HI_HI_PRI, HI_PRI, LO_LO_PRI and LO_PRI parameters. Reporting to the field host system only takes place with alarms with a priority greater than 2.
8. Set the block mode to Auto using the MODE_BLK parameter, TARGET element. For this purpose, the Resource Block must also be set to the "Auto" block mode.

Additional configuration

1. Depending on the control or automation task, configure additional function blocks and output blocks. → See also Operating Instructions BA00303P "Description of Device Functions Cerabar S/Deltabar S/Deltapilot S".
2. Link the function blocks and output blocks.
3. After specifying the active LAS, download all the data and parameters to the field device.

6.2 Selecting the language and measuring mode

6.2.1 Local operation

The MEASURING MODE parameter is on the 1st selection level.

→  18, Section 5.3.1 "Structure of the operating menu".

The following measuring modes are available:

- Pressure
- Level

6.2.2 Selecting the language and measuring mode via FieldCare

The parameters for setting the measuring mode are displayed in the FieldCare "Measuring mode" menu.

The following measuring modes are available:

- Pressure
- Level

The LANGUAGE parameter is arranged in the DISPLAY group.

- Select the menu language for FieldCare using the "Language Button" in the configuration window. Select the menu language for the FieldCare frame by means of the "Extra" menu → "Options" "Display" → "Language".

The following languages are available:

- Deutsch
- English
- Français
- Español
- Chinese
- Japanese

6.3 Position adjustment

Due to the orientation of the device, there may be a shift in the measured value, i.e. when the container is empty or partly filled, the measured value parameter does not display zero. There are two options to choose from when performing position adjustment.

- Onsite display menu path: GROUP SELECTION → OPERATING MENU → SETTINGS → POSITION ADJUSTMENT
- FieldCare menu path: OPERATING MENU → SETTINGS → POSITION ADJUSTMENT

6.3.1 Performing position adjustment via the onsite display or FieldCare

The parameters listed in the following table can be found in the POSITION ADJUSTMENT group (menu path: OPERATING MENU → SETTINGS → POSITION ADJUSTMENT).

Parameter name	Description
POS. ZERO ADJUST Entry	<p>Position adjustment – the pressure difference between zero (set point) and the measured pressure need not be known.</p> <p>Example:</p> <ul style="list-style-type: none"> – MEASURED VALUE = 2.2 mbar – Correct the MEASURED VALUE via the POS. ZERO ADJUST parameter with the "Confirm" option. This means that you are assigning the value 0.0 to the pressure present. – MEASURED VALUE (after pos. zero adjust) = 0.0 mbar <p>The CALIB. OFFSET parameter displays the resulting pressure difference (offset) by which the MEASURED VALUE was corrected.</p> <p>Factory setting: 0.0</p>
POS. INPUT VALUE Input	<p>Position adjustment – the pressure difference between zero (set point) and the measured pressure need not be known. To correct the pressure difference, you need a reference measurement value (e. g. from a reference device).</p> <p>Example:</p> <ul style="list-style-type: none"> – MEASURED VALUE = 0.5 mbar – For the POS. INPUT VALUE parameter, specify the desired set point for the MEASURED VALUE, e.g. 2 mbar. (The following applies: $\text{MEASURED VALUE}_{\text{new}} = \text{POS. INPUT VALUE}$) – MEASURED VALUE (after entry for POS. INPUT VALUE) = 2.0 mbar – The CALIB. OFFSET parameter displays the resulting pressure difference (offset) by which the MEASURED VALUE was corrected. The following applies: $\text{CALIB. OFFSET} = \text{MEASURED VALUE}_{\text{old}} - \text{POS. INPUT VALUE}$, here: $\text{CALIB. OFFSET} = 0.5 \text{ mbar} - 2.0 \text{ mbar} = -1.5 \text{ mbar}$) <p>Factory setting: 0.0</p>
CALIB. OFFSET Entry	<p>Position adjustment – the pressure difference between zero (set point) and the measured pressure is known. (A reference pressure is not present at the device.)</p> <p>Example:</p> <ul style="list-style-type: none"> – MEASURED VALUE = 2.2 mbar – Via the CALIB. OFFSET parameter, enter the value by which the MEASURED VALUE should be corrected. To correct the MEASURED VALUE to 0.0 mbar, you must enter the value 2.2 here. (The following applies: $\text{MEASURED VALUE}_{\text{new}} = \text{MEASURED VALUE}_{\text{old}} - \text{CALIB. OFFSET}$) – MEASURED VALUE (after entry for calib. offset) = 0.0 mbar <p>Factory setting: 0.0</p>

6.4 Pressure measurement

6.4.1 Information on pressure measurement



Note!

- A Quick Setup menu is available for each of the measuring modes Pressure and Level which guides you through the most important basic functions. With the setting in the MEASURING MODE parameter, you specify which Quick Setup menu should be displayed. See also Section 6.2 "Selecting the language and measuring mode".
- For a detailed description of the parameters, see Operating Instructions BA00303P "Cerabar S/Deltabar S/Deltapilot S, Description of Device Functions"
 - FF: Table, Pressure Transducer Block
 - FieldCare: Table, POSITION ADJUSTMENT
 - FieldCare: Table, BASIC SETUP
 - FieldCare: Table, EXTENDED SETUP

6.4.2 Quick Setup menu for the Pressure measuring mode

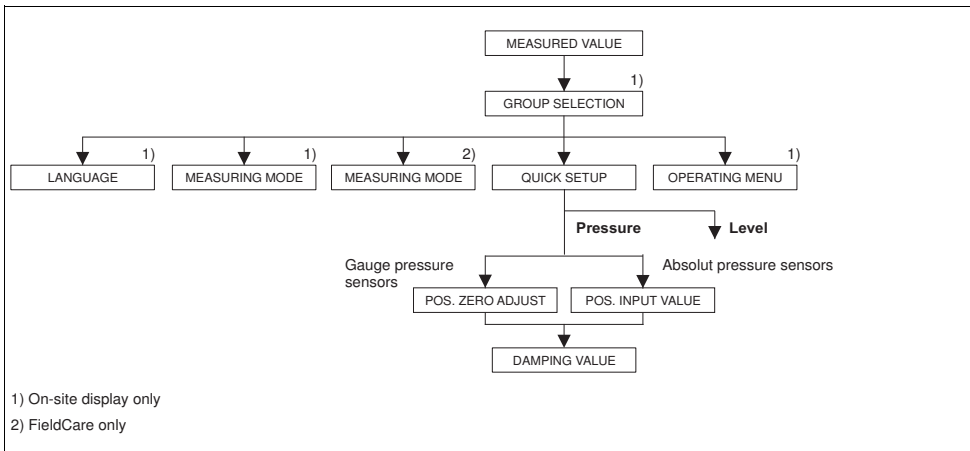



Fig. 8: Quick Setup menu for the "Pressure" measuring mode



F01-FPMX/XXXX-19-XX-XX-01-076

Local operation
Measured value display Switch from the measured value display to the GROUP SELECTION with  .
GROUP SELECTION Select the MEASURING MODE parameter.
MEASURING MODE Select "Pressure".
GROUP SELECTION Select QUICK SETUP menu.
POS. ZERO ADJUST Due to orientation of the device, there may be a shift in the measured value. You correct the MEASURED VALUE via the POS. ZERO ADJUST parameter with the "Confirm" option, i.e. you assign the value 0.0 to the pressure present.
POS. INPUT VALUE Due to orientation of the device, there may be a shift in the measured value. For the POS. INPUT VALUE parameter, specify the desired set point for the MEASURED VALUE.
DAMPING VALUE Enter damping time (time constant τ). The damping affects the speed at which all subsequent elements, such as the onsite display, measured value and OUT Value of the Analog Input Block react to a change in the pressure.

FieldCare
Measured value display Select QUICK SETUP menu.
Measuring Mode Select the Primary Value Type parameter.
Primary Value Type Select "Pressure".
POS. ZERO ADJUST Due to orientation of the device, there may be a shift in the measured value. You correct the MEASURED VALUE via the POS. ZERO ADJUST parameter with the "Confirm" option, i.e. you assign the value 0.0 to the pressure present.
POS. INPUT VALUE Due to orientation of the device, there may be a shift in the measured value. For the POS. INPUT VALUE parameter, specify the desired set point for the MEASURED VALUE.
DAMPING VALUE Enter damping time (time constant τ). The damping affects the speed at which all subsequent elements, such as the onsite display, measured value and OUT Value of the Analog Input Block react to a change in the pressure.



Note!

For local operation see also →  17, Section 5.2.3 "Function of the operating elements – onsite display connected" and →  18, Section 5.3 "Onsite operation via onsite display".

6.5 Level measurement

6.5.1 Information on level measurement



Note!

- A Quick Setup menu is available for each of the measuring modes Pressure and Level which guides you through the most important basic functions. → For the "Level" Quick Setup menu, see → 33.
- Furthermore, three level modes are available for the level measurement, namely "Level easy pressure", "Level easy height" and "Level standard". For the "Level standard" level mode, you can choose between the "Linear", "Pressure linearized" and "Height linearized" level types. The table in the "Overview of level measurement" section that follows provides you with an overview of the various measuring tasks.
 - With regard to the "Level easy pressure" and "Level easy height" level modes, the values entered are not tested as extensively as in the "Level standard" level mode. In the "Level easy pressure" and "Level easy height" level modes, the values entered for EMPTY CALIBRATION/FULL CALIBRATION, EMPTY PRESSURE/FULL PRESSURE and EMPTY HEIGHT/FULL HEIGHT have to be at least 1 % apart. If the values are too close together, the value is rejected and the system outputs a message. Other limit values are not checked, i.e. for the device to be able to perform correct measurement, the values entered have to suit the sensor and the measuring task.
 - The "Level easy pressure" and "Level easy height" level modes comprise fewer parameters than the "Level standard" mode and are used to quickly and easily configure a level application.
 - Customer-specific units of level, volume and mass, or a linearization table, can only be entered in the "Level standard" level mode.
- For a detailed description of the parameters and configuration examples, see Operating Instructions BA00303P "Cerabar S/Deltabar S/Deltapilot S, Description of Device Functions".

6.5.2 Overview of level measurement

Measuring task	LEVEL SELECTION/LEVEL MODE	Measured variable selection	Description	Comment	Measured value display
The measured variable is in direct proportion to the measured pressure. Calibration takes place by entering two pressure-level pairs.	LEVEL SELECTION: Level easy pressure	Via the OUTPUT UNIT parameter: %, level, volume or mass units.	<ul style="list-style-type: none"> - Calibration with reference pressure – wet calibration, see Operating Instructions BA00303P. - Calibration without reference pressure – dry calibration, see Operating Instructions BA00303P. 	<ul style="list-style-type: none"> - Incorrect entries are possible - Customer-specific units are not possible 	The measured value display and the LEVEL BEFORE LIN. parameter show the measured value.
The measured variable is in direct proportion to the measured pressure. Calibration takes place by entering the density and two height-level pairs.	LEVEL SELECTION: Level easy height	Via the OUTPUT UNIT parameter: %, level, volume or mass units.	<ul style="list-style-type: none"> - Calibration with reference pressure – wet calibration, see Operating Instructions BA00303P. - Calibration without reference pressure – dry calibration, see Operating Instructions BA00303P. 	<ul style="list-style-type: none"> - Incorrect entries are possible - Customer-specific units are not possible 	The measured value display and the LEVEL BEFORE LIN. parameter show the measured value.
The measured variable is in direct proportion to the measured pressure.	LEVEL SELECTION: Level standard/ LEVEL MODE: Linear	Via the LINEAR MEASURAND parameter: <ul style="list-style-type: none"> - % (level) - Level - Volume - Mass 	<ul style="list-style-type: none"> - Calibration with reference pressure – wet calibration, see Operating Instructions BA00303P. - Calibration without reference pressure – dry calibration, see Operating Instructions BA00303P. 	<ul style="list-style-type: none"> - Incorrect entries are denied by the device - Customer-specific units of level, volume and mass are possible 	The measured value display and the LEVEL BEFORE LIN. parameter show the measured value.

Measuring task	LEVEL SELECTION/LEVEL MODE	Measured variable selection	Description	Comment	Measured value display
<p>The measured variable is not in direct proportion to the measured pressure as is the case with tanks with a conical outlet, for example. A linearization table has to be entered for the calibration.</p>	<p>LEVEL SELECTION: level standard/ LEVEL MODE: pressure linearized</p>	<p>Via the LINd. MEASURAND parameter: <ul style="list-style-type: none"> - Pressure + % - Pressure + volume - Pressure + mass </p>	<ul style="list-style-type: none"> - Calibration with reference pressure: semiautomatic entry of linearization table, see Operating Instructions BA00303P. - Calibration without reference pressure: manual entry of linearization table, see Operating Instructions BA00303P. 	<ul style="list-style-type: none"> - Incorrect entries are denied by the device - Customer-specific units of level, volume and mass are possible 	<p>The measured value display and the TANK CONTENT parameter display the measured value.</p>
<ul style="list-style-type: none"> - Two measured variables are required or - the tank shape is given with value pairs, e.g. height and volume. <p>The 1st measured variable % height or height must be in direct proportion to the measured pressure. The 2nd measured variable volume, mass or % must not be in direct proportion to the measured pressure. A linearization table has to be entered for the 2nd measured variable. The 2nd measured variable is assigned to the 1st measured variable by means of this table.</p>	<p>LEVEL SELECTION: Level standard/ LEVEL MODE: Height linearized</p>	<p>Via the COMB. MEASURAND parameter: <ul style="list-style-type: none"> - Height + volume - Height + mass - Height + % - %-height + volume - %-height + mass - %-height + % </p>	<ul style="list-style-type: none"> - Calibration with reference pressure: wet calibration and semiautomatic entry of linearization table, see Operating Instructions BA00303P. - Calibration without reference pressure: dry calibration and manual entry of linearization table, see Operating Instructions BA00303P. 	<ul style="list-style-type: none"> - Incorrect entries are denied by the device - Customer-specific units of level, volume and mass are possible 	<p>The measured value display and the TANK CONTENT parameter display the 2nd measured value (volume, mass or %).</p> <p>The LEVEL BEFORE LIN parameter displays the 1st measured value (%-height or height).</p>

6.5.3 Quick Setup menu for the Level measuring mode



Note!

- Some parameters are only displayed if other parameters are appropriately configured. For example, the EMPTY CALIBRATION parameter is only displayed in the following instances:
 - LEVEL SELECTION "Level easy pressure" and CALIBRATION MODE "Wet"
 - LEVEL SELECTION "Level standard", LEVEL MODE "Linear" and CALIBRATION MODE "Wet"

The LEVEL MODE and CALIBRATION MODE parameters are in the BASIC SETUP function group.

- The following parameters are set to the following values at the factory:
 - LEVEL SELECTION: Level easy pressure
 - CALIBRATION MODE: Wet
 - OUTPUT UNIT or LIN. MEASURAND: %
 - EMPTY CALIBRATION: 0.0
 - FULL CALIBRATION: 100.0
- The Quick Setup is suitable for easy and quick commissioning. If you want to make more complex settings like changing the unit from "%" to "m", the calibration must be performed via the BASIC SETUP group. → See Operating Instructions BA00303P.

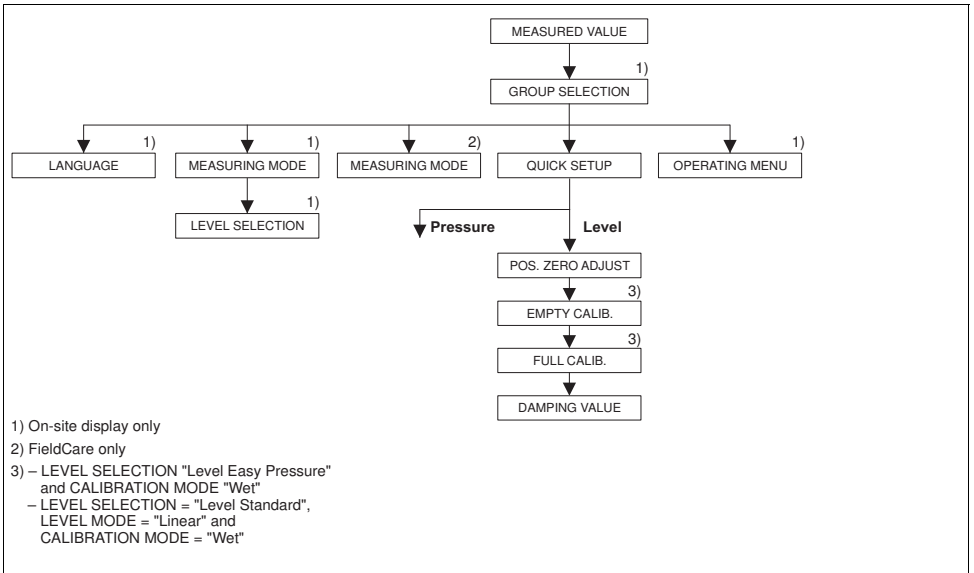





Fig. 9: Quick Setup menu for the "Level" measuring mode"

P01-FMB7/0xxx-19-xx-xx-eb-015



Local operation
Measured value display Switch from the measured value display to the GROUP SELECTION with  .
GROUP SELECTION Select the MEASURING MODE.
MEASURING MODE Select "Level".
LEVEL SELECTION Select the level mode. For an overview, see →  31.
GROUP SELECTION Select QUICK SETUP menu.
POS. ZERO ADJUST Due to orientation of the device, there may be a shift in the measured value. You correct the MEASURED VALUE via the POS. ZERO ADJUST parameter with the "Confirm" option, i.e. you assign the value 0.0 to the pressure present.
EMPTY CALIBRATION ¹⁾ Enter level value for the lower calibration point. For this parameter, enter a level value which is assigned to the pressure present at the device.
FULL CALIBRATION ¹⁾ Enter level value for the upper calibration point. For this parameter, enter a level value which is assigned to the pressure present at the device.
DAMPING VALUE Enter damping time (time constant τ). The damping affects the speed at which all subsequent elements, such as the onsite display, measured value and OUT Value of the Analog Input Block react to a change in the pressure.

FieldCare
Measured value display Select QUICK SETUP menu.
Measuring Mode Select the Primary Value Type parameter.
Primary Value Type Select "Level" option.
LEVEL SELECTION / Level Selection Select the level mode. For an overview, see →  31.
POS. ZERO ADJUST Due to orientation of the device, there may be a shift in the measured value. You correct the MEASURED VALUE via the POS. ZERO ADJUST parameter with the "Confirm" option, i.e. you assign the value 0.0 to the pressure present.
EMPTY CALIBRATION ¹⁾ Enter level value for the lower calibration point. For this parameter, enter a level value which is assigned to the pressure present at the device.
FULL CALIBRATION ¹⁾ Enter level value for the upper calibration point. For this parameter, enter a level value which is assigned to the pressure present at the device.
DAMPING VALUE Enter damping time (time constant τ). The damping affects the speed at which all subsequent elements, such as the onsite display, measured value and OUT Value of the Analog Input Block react to a change in the pressure.

- 1) – LEVEL SELECTION "Level easy pressure" and CALIBRATION MODE "Wet"
– LEVEL SELECTION "Level standard", LEVEL MODE "Linear" and CALIBRATION MODE "Wet"



Note!

For local operation see also →  17, Section 5.2.3 "Function of the operating elements – onsite display connected" and →  18, Section 5.3 "Onsite operation via onsite display".

6.6 Scaling the OUT parameter

In the Analog Input Block, the input value or input range can be scaled in accordance with the automation requirements.

Example:

The measuring range 0 to 500 mbar should be rescaled to 0 to 100 %.

- Select XD_SCALE group.
 - For EU_0, enter "0".
 - For EU_100, enter "500".
 - For UNITS_INDEX, enter "mbar".
- Select OUT_SCALE group.
 - For EU_0, enter "0".
 - For EU_100, enter "10000".
 - For UNITS_INDEX, select "%" for example.

The unit selected here does not have any effect on the scaling. This unit is not displayed on the onsite display or in the operating program such as FieldCare.

■ Result:

At a pressure of 350 mbar, the value 70 is output to a downstream block or to the PCS as the OUT value.

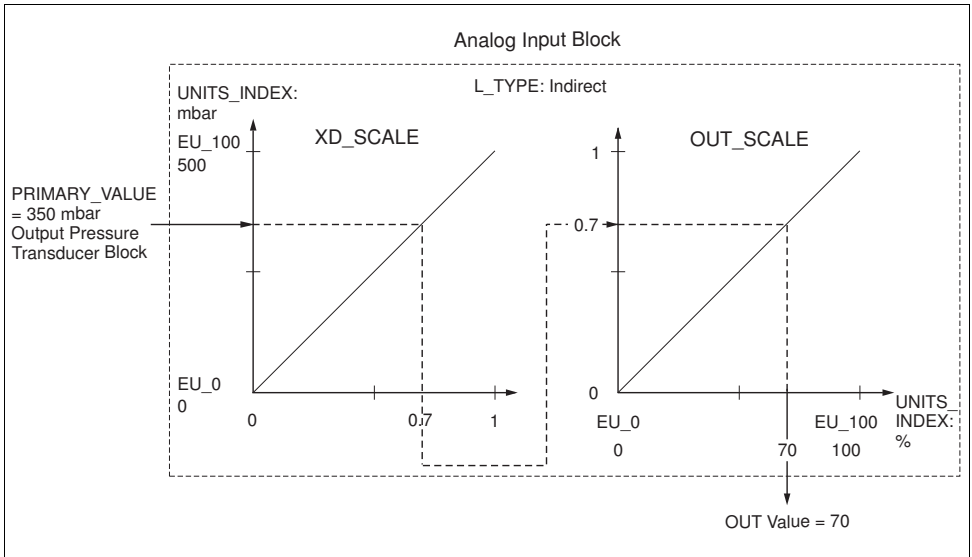

P01-xMx7xxxx-05-xx-xx-en-008

**Note!**

- If you have selected the "Direct" mode for the L_TYPE parameter, you cannot change the values and units for XD_SCALE and OUT_SCALE.
- The L_TYPE, XD_SCALE and OUT_SCALE parameters can only be changed in the OOS block mode.
- Make sure that the output scaling of the Pressure Transducer Block SCALE_OUT matches the input scaling of the Analog Input Block XD_SCALE.

www.endress.com/worldwide

Endress+Hauser 
People for Process Automation

KA01025P/00/EN/16.14
71270355
CCS/FM+SGML 9.0

