

Brief Operating Instructions GammapiLOT M FMG60

Radiometric Measurement

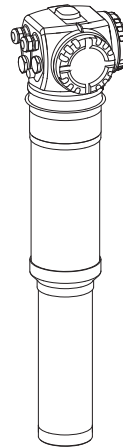

These Instructions are Brief Operating Instructions; they do not replace the Operating Instructions included in the scope of supply.

For detailed information, refer to the Operating Instructions and other documentation on the CD-ROM provided or visit "www.endress.com/deviceviewer".

Table of contents

1	Safety instructions	3
1.1	Designated use	3
1.2	Installation, commissioning, operation	3
1.3	Operational safety and process safety	3
1.4	Hazardous area	4
1.5	Radiation protection	5
1.6	Symbols	6
2	Installation	8
2.1	Incoming acceptance, transport, storage	8
2.2	Installation conditions	8
2.3	Water cooling	12
2.4	Installation check	12
3	Wiring	13
3.1	Cable entries	14
3.2	Terminal assignment	15
3.3	Potential equalization	16
3.4	Wiring in terminal compartment 1	17
3.5	Wiring in terminal compartment 2	18
3.6	Connecting the remote display and operation FHX40	19
3.7	Wiring in cascading mode	19
3.8	Wiring example for point level detection 200/400mm	20
3.9	Post-connection check	21
4	Operation	22
4.1	General structure of the operating menu	22
4.2	Display and operating elements	23
5	Commissioning	25
5.1	Calibration: overview	25
5.2	Function check	25
5.3	Switching on the measuring device	26
5.4	Basic setup	27
5.5	Calibration for level measurement and limit detection	34
5.6	Calibration for density and concentration measurements	46
5.7	Density measurement/temperature-compensated	58
5.8	Gammagraphy detection	58
5.9	SIL locking (for point level detection 200/400 mm PVT scintillator)	58

1 Safety instructions

1.1 Designated use

The Gammapilot M is a compact transmitter for non-contact level, level limit, density and concentration measurement. The measuring range of a single Gammapilot M extends up to 2 m (6.6 ft). Large measuring ranges of any size can be implemented, however, by cascading several Gammapilot M devices. When used for level limit detection, the Gammapilot M is certified according to IEC 61508 for safety-related operation up to SIL 2/3.

1.2 Installation, commissioning, operation

The Gammapilot M is fail-safe and is constructed to the state-of-the-art. It meets the appropriate standards and EC directives. However, if you use it improperly or other than for its designated use, it may pose application-specific hazards, e.g. product overflow due to incorrect installation or configuration. Installation, electrical connection, startup, operation and maintenance of the measuring device must therefore be carried out exclusively by trained specialists authorized by the system operator. Technical personnel must have read and understood these Operating Instructions and must adhere to them. You may only undertake modifications or repair work to the device when it is expressly permitted by the Operating Instructions.

1.3 Operational safety and process safety

- Alternative monitoring measures must be taken to ensure operational safety and process safety during configuration, testing and maintenance work on the device.
- The device is safely built and tested according to state-of-the-art technology and has left the factory in perfect condition as regards technical safety. The applicable regulations and European standards have been taken into account.
- Pay particular attention to the technical data on the nameplate.
- If the device is to be installed in an explosion hazardous area, then the specifications in the certificate as well as all national and local regulations must be observed. The device is accompanied by separate "Ex documentation", which is an integral part of this Operating Instructions. The installation regulations, connection values and Safety Instructions listed in this Ex document must be observed. The documentation number of the related Safety Instructions is also indicated.
- If using devices for applications with safety integrity level, the separate manual on functional safety must be observed thoroughly (see CD-ROM).

1.4 Hazardous area

Measuring systems for use in hazardous environments are accompanied by separate "Ex documentation", which is an integral part of these Operating Instructions. Strict compliance with the installation instructions and ratings as stated in this supplementary documentation is mandatory.

- Ensure that all personnel are suitably qualified.
- Observe the specifications in the certificate as well as national and local standards and regulations.

⚠ CAUTION

Detector or cooling jacket can be damaged if the cooling water freezes.

Empty cooling jacket or protect against freezing.

⚠ WARNING

The three screws, connecting the pipe housing to the compartment housing, must not be opened.

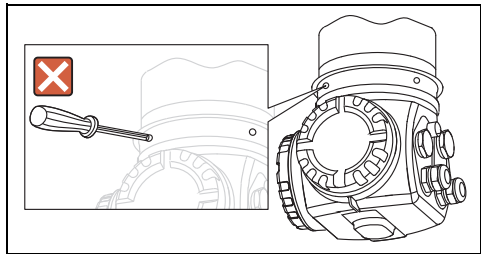

A0018068

⚠ WARNING

Depending on the certificate version observe the associated Safety Instructions (see "Documentation", BA00236F/00/EN).

1.5 Radiation protection

The Gammapilot M is used in conjunction with a radioactive source, contained in a source container. When handling radioactive sources, the following instructions have to be observed:

1.5.1 Basic regulations on radiation protection

⚠ WARNING

When handling radioactive sources, all unnecessary radiation exposure should be avoided. All unavoidable radiation exposure should be kept as low as possible. Three measures are used for this:

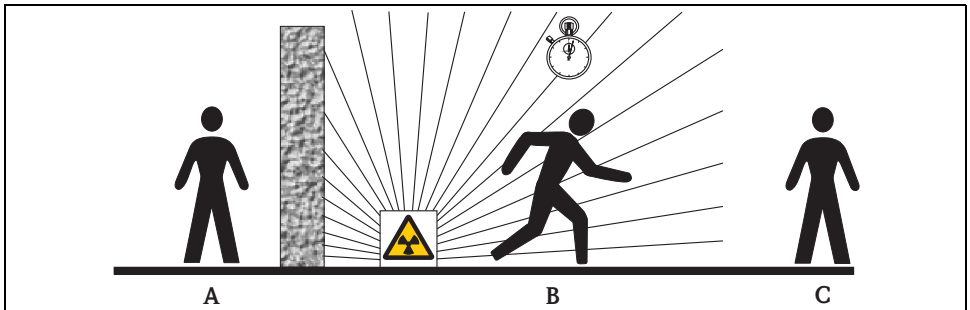

- A Screening
 B Time
 C Distance

A0016373

Shielding

Ensure the best possible shielding between the radiation source and yourself as well as all other individuals. Effective shielding is provided by source containers (FQG60, FQG61/ FQG62, FQG63, QG2000) and all high-density materials (lead, iron, concrete).

⚠ CAUTION

When working with source containers, all the instructions for mounting and usage outlined in the following documents must be observed:

Source Container	Document
FQG60	TI00445F/00/EN
FQG61, FQG62	TI00435F/00/EN
FQG63	TI00446F/00/EN
QG2000	TI00346F/00/EN BA00223F/00/EN

Time





Stay as short as possible in the area exposed to radiation.

Distance



Keep as far away as possible from the radiation source. The local radiation intensity decreases as the square-root of the distance from the radiation source.

1.6 Symbols

1.6.1 Safety symbols

Symbol	Meaning
 <small>A0011189-DE</small>	<p>DANGER!</p> <p>This symbol alerts you to a dangerous situation. Failure to avoid this situation will result in serious or fatal injury.</p>
 <small>A0011190-DE</small>	<p>WARNING!</p> <p>This symbol alerts you to a dangerous situation. Failure to avoid this situation can result in serious or fatal injury.</p>
 <small>A0011191-DE</small>	<p>CAUTION!</p> <p>This symbol alerts you to a dangerous situation. Failure to avoid this situation can result in minor or medium injury.</p>
 <small>A0011192-DE</small>	<p>NOTICE!</p> <p>This symbol contains information on procedures and other facts which do not result in personal injury.</p>





1.6.2 Electrical symbols

Symbol	Meaning
 <small>A0018338</small>	<p>Ground connection</p> <p>A grounded terminal which, as far as the operator is concerned, is grounded via a grounding system.</p>
 <small>A0018339</small>	<p>Protective ground connection</p> <p>A terminal which must be connected to ground prior to establishing any other connections.</p>



1.6.3 Tool symbols

Symbol	Meaning
 A0011221	Allen key

1.6.4 Symbols for certain types of information

Symbol	Meaning
 A0011182	Allowed Indicates procedures, processes or actions that are allowed.
 A0011183	Preferred Indicates procedures, processes or actions that are preferred.
 A0011184	Forbidden Indicates procedures, processes or actions that are forbidden.
 A0011193	Tip Indicates additional information.
 A0015484	Reference to page Refers to the corresponding page number.
1. , 2. , ...	Series of steps

1.6.5 Symbols in graphics

Symbol	Meaning
1, 2, 3, 4, ...	Item numbers
1. , 2. , ...	Series of steps
A, B, C, D, ...	Views
 A0011187	Hazardous area Indicates a hazardous area.
 A0011188	Safe area (non-hazardous area) Indicates a non-hazardous location.

2 Installation

2.1 Incoming acceptance, transport, storage

2.1.1 Incoming acceptance

Check the packing and contents for any signs of damage.

Check the shipment, make sure nothing is missing and that the scope of supply matches your order.

2.1.2 Transport

⚠ CAUTION

Follow the safety instructions and transport conditions for devices of more than 18 kg (39.69 lbs).

2.1.3 Storage

Pack the measuring instrument so that it is protected against impacts for storage and transport. The original packing material provides the optimum protection for this.

The permissible storage temperature is:

- -40 to +50 °C (-40 to +122 °F) for devices with PVT scintillator
- -40 to +60 °C (-40 to +140 °F) for devices with NaI crystal

2.2 Installation conditions

2.2.1 General Installation conditions

Conditions

- The exit angle of the source container must be exactly aligned to the measuring range of the Gammapiilot M. Observe the measuring range marks of the Gammapiilot M.
- The source container and the Gammapiilot M must be mounted as close to the vessel as possible. Any access to the beam must be blocked so that no persons or part of their body (hand, arm, head) may come into the area of the beam.
- In order to enlarge the lifetime, the Gammapiilot M should be protected against direct sun. If necessary, a protective cover should be applied.
- The mounting device FHG60 (see BA00236F/00/EN, Chapter "Accessories") or an equivalent mounting device should be used for fastening the Gammapiilot M. The mounting device must be installed in a way such that it can withstand the weight of the Gammapiilot M¹⁾ under all operating conditions (e.g. vibrations).

1) The weights of the various versions, see BA00236F/00/EN "Dimensions/Weight".

2.2.2 Installation conditions for level measurement

Conditions

- For level measurements the Gammapiilot M is mounted vertically; if possible the detector head should point downwards.
- In cascading mode no gap should occur between the measuring ranges of the different Gammapiilot M.

NOTICE

The Gammapiilot M should be given additional support to prevent damage to the connecting cable or to the unit if it falls off.

Examples

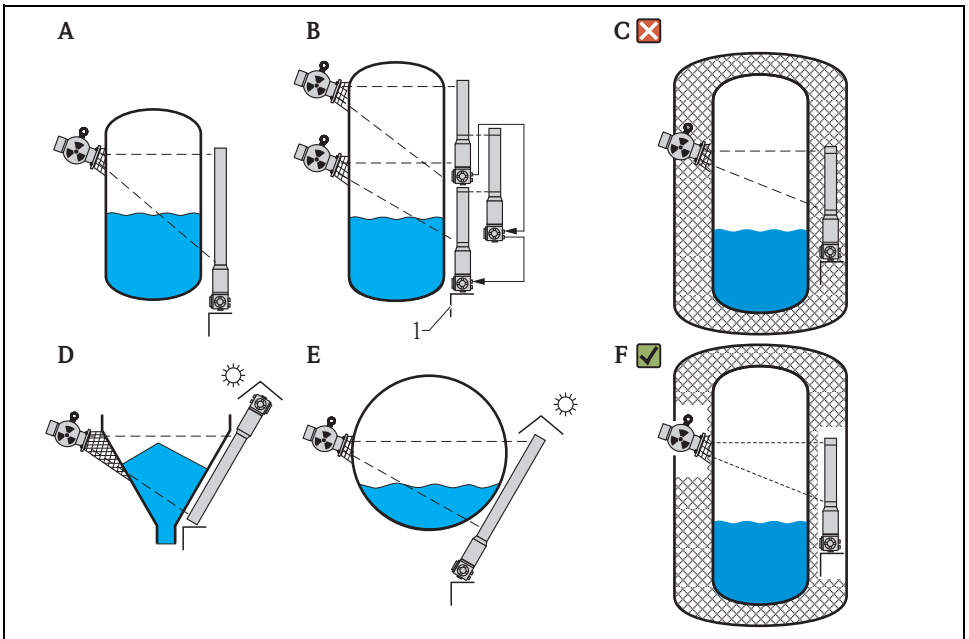

- A Vertical cylinder; the Gammapiilot M is mounted vertically with the detector head pointing downwards; the gamma ray is aligned to the measuring range.
- B Cascading of multiple Gammapiilot M; there is no gap between the measuring ranges
- C Wrong; Gammapiilot M mounted inside the tank insulation
- D Conical tank outlet (here with sun protection cover)
- E Horizontal cylinder (here with sun protection cover)
- F Right; Tank insulation removed for Gammapiilot M

- 1 Support

A0018074

2.2.3 Installation conditions for point level detection

Condition

For point level detection, the Gammapilot M should be mounted horizontally at the height of the desired level limit.

 More information with regard to the safety-related deployment of Gammapilot M can be found in Functional Safety Manual SD00230F/00/EN and SD00324F/00/EN.

Examples

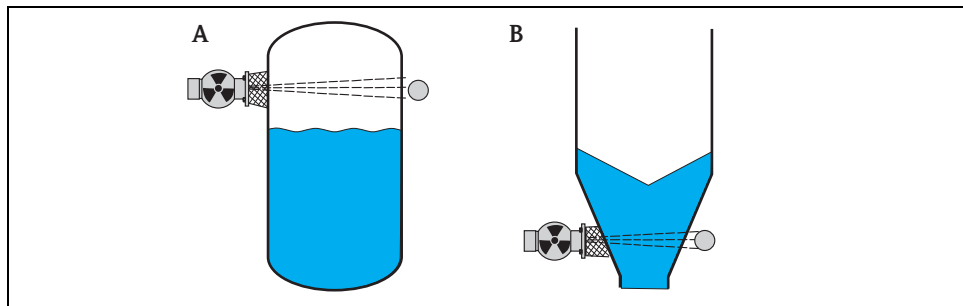

A *Maximum fail-safe mode*
 B *Minimum point level detection*

A0018075

2.2.4 Installation conditions for density and concentration measurement

Conditions

- If possible, density and concentration should be measured at vertical pipes with a feed direction from bottom to top.
- If only horizontal pipes are accessible, the path of the ray should also be arranged horizontally to reduce the influence of air bubbles and sediments..
- The Endress+Hauser clamping device (see BA00236F/00/EN, Chapter "Accessories") or an equivalent clamping device should be used for fastening the radiation source container and the Gammapilot M to the measuring tube. The clamping device itself must be installed in a way such that it can withstand the weight of the source container²⁾ and the Gammapilot M³⁾ under all operating conditions.
- The sample point may not be further than 20 m (66 ft) from the measuring point.
- The distance of the density measurement to pipe bends is $\geq 3 \times$ pipe diameter and $\geq 10 \times$ pipe diameter for pumps.

2) The weights of the source containers are specified in TI00445F/00/EN (FQG60), TI00435F/00/EN (FQG61, FQG62), TI00446F/00/EN (FQG63) bzw. TI00346F/00/EN (QG2000).

3) The weights of the various versions, see BA00236F/00/EN, "Dimensions/Weight".

Configuration of the measuring system

The configuration of the source container and the Gammapilot M depends on the pipe diameter (or the length of the irradiated measuring path respectively) and the measuring range. These two parameters determine the measuring effect (relative change of the pulse rate). The measuring effect increases with the length of the radiation path through the medium. Therefore, diagonal irradiation or the use of a measurement section is necessary for small pipe diameters.

For the configuration of the measuring system please contact your Endress+Hauser sales organization or use the "Applicator"^{TM 4)} configuration software.

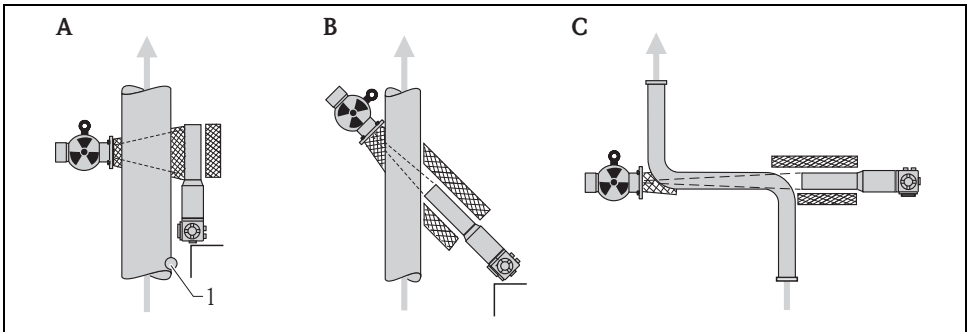

- A Vertical beam (90°)
 B Diagonal beam (30°)
 C Measurement section
 1 Sample point

A0018076

NOTICE

General

- ▶ To increase the accuracy for density measurements, the use of a collimator is recommended. The collimator screens the detector against environmental radiation.
- ▶ When planning, the total weight of the measuring system must be taken into consideration.
- ▶ The Gammapilot M should be given additional support to secure it against falling or prevent damage to the connecting cable.
- ▶ A clamping device and a measurement section are available as accessories (see BA00236F/00/EN, chapter "Accessories").

4) The "Applicator"TM is available from your Endress+Hauser sales organization.

2.3 Water cooling

"Water cooling", see BA00236F/00/EN.

2.4 Installation check

After installing the device, carry out the following checks:

- Is the device damaged (visual inspection)?
- Does the device correspond to the measuring point specifications for ambient temperature, measuring range etc.?
- If available: Are the measuring point number and labeling correct (visual inspection)?
- Is the measuring device sufficiently protected against direct sunlight?
- Are the cable glands tightened correctly?

3 Wiring

The Gammapilot M has got two terminal compartments:

- Terminal compartment 1, for
 - Power supply
 - Signal output (depending on the instrument version)
- Terminal compartment 2, for
 - Signal output (depending on the instrument version)
 - PT-100 input (4-wire)
 - Pulse input for cascading mode
 - Pulse output for cascading mode
 - Display and operating module FHX40 (or VU331)

NOTICE

Depending on the instrument version, the signal output is located in the terminal compartment 1 or 2.

Maximum cable length:

- For cascade, 20 m (66 ft) each
- For PT-100 2 m (6.6 ft) (temperature should be measured as close as possible to density measurement)

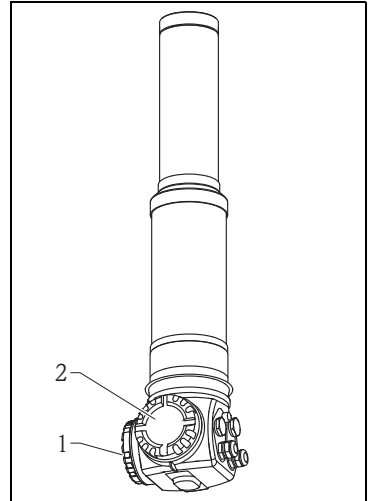

A001808Z

3.1 Cable entries

The number and type of cable entries depend on the instrument version ordered. The following types may occur:

- Gland M20x1.5
tightening diameter (clamping range):
7.0 to 10.5 mm
- Cable entry M20x1.5
- Cable entry G1/2
- Cable entry NPT1/2
- M12 connector
- 7/8" connector

In addition, Gammapilot M has a socket to connect the separate display and operating unit FHX40. The housing of the Gammapilot M does not have to be opened to connect the FHX40.

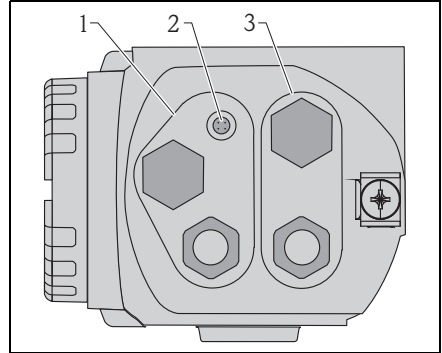

- A0018083
- 1 Cable entries for terminal compartment 2
 - 2 Socket for FHX40
 - 3 Cable entries for terminal compartment 1

NOTICE

Cable entries

- ▶ On delivery, not more than one cable gland is present for each of the terminal compartments. If further cable glands are required (e.g. for cascading mode), they must be supplied by the user.
- ▶ Connecting cables should be routed away from the housing from below to prevent moisture from penetrating the connection compartment. Otherwise, a drain loop should be provided or the Gammapilot M should be fitted with a weather protection cover.

3.2 Terminal assignment

Terminal compartment 1

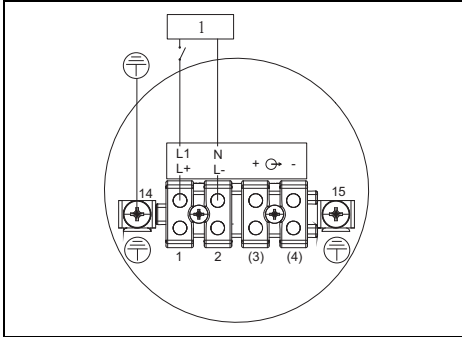

1 90 to 253VAC, 18 to 36 VDC

A0018084

Terminal compartment 2

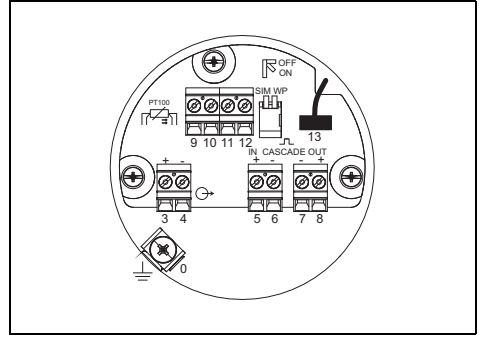

A0018085

Terminal(s)	Meaning
0	Grounding of the cable screen ¹⁾
1, 2	Power supply ²⁾
Compartment 2: 3, 4 Compartment 1: (3) ¹⁾ , (4) ¹⁾	Signal output, depending on communication version: <ul style="list-style-type: none"> ■ 4-20mA with HART ■ PROFIBUS PA ■ Foundation Fieldbus (Depending on the device version ordered, the signal output is in connection compartment 1 or 2, see below)
	NOTICE For the versions of the Gammapilot M with fieldbus plug connectors (M12 or 7/8"), the signal output is wired in compartment 2 on delivery and connected to the fieldbus plug connector. In this case, the housing needs not to be opened for connecting the signal line.
5, 6	Pulse input (for cascading mode; is used for master and slave)
7, 8	Pulse output (for cascading mode; is used for slave and end slave)
9, 10, 11, 12	PT-100 input (4-wire)
13	Plug for display and operating module VU331 (normally in FHX40); is wired on delivery and connected to the FHX40 plug
14	Protective earth ¹⁾
15	Protective earth or grounding of the cable screen ¹⁾

1) Rated cross section > 1 mm² (17 AWG)

2) Rated cross section max. 2.5 mm² (14 AWG)

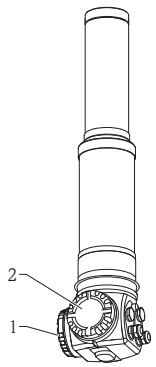
Feature 30 of the ordering information: Power supply wiring/output wiring		Terminal compartment for		
		Supply voltage	Signal output	
A	Non-Ex; Non-Ex	1	2	
B	Ex e; Ex ia	1	2	
C	Ex e; Ex e	1	1	
D	Ex d (XP); Ex d (XP)	1	1	
E	Ex d (XP); Ex ia (IS)	1	2	
F	Dust-Ex; Dust-Ex	1	1	
G	Ex e, Dust-Ex; Ex e, Dust-Ex	1	1	
H	Ex d, Dust-Ex; Ex d, Dust-Ex	1	1	
J	Ex e, Dust-Ex; Ex ia, Dust-Ex	1	2	
K	Ex d, Dust-Ex; Ex ia, Dust-Ex	1	2	
L	Dust-Ex; Ex ia	1	2	

A0018082

3.3 Potential equalization

Before wiring, connect the potential matching line to the external ground terminal of the transmitter. If a water cooling jacket is present, it must be separately connected to the potential matching line.

⚠ CAUTION

In Ex applications, the instrument must only be grounded on the sensor side. Further safety instructions are given in the separate documentation for applications in explosion hazardous areas.

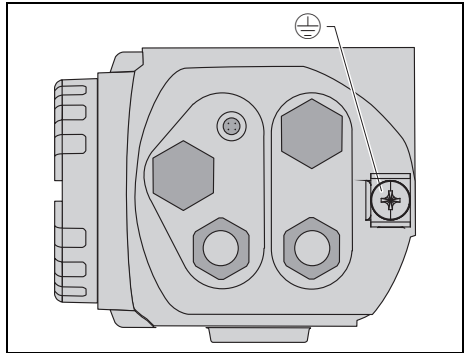

A0018086

NOTICE

For optimum electromagnetic compatibility the potential matching line should be as short as possible and at least 2.5 mm² (14 AWG) in cross-section.

3.4 Wiring in terminal compartment 1

⚠ CAUTION

Before connection please note the following:

- ▶ When using the instrument in hazardous areas, make sure to comply with national standards and the specifications in the Safety Instructions (XAs). Make sure you use the specified cable gland.
- ▶ The supply voltage must comply to the data on the nameplate.
- ▶ Switch off power supply before connecting the instrument.
- ▶ Connect potential matching line to the outer transmitter ground terminal and to the ground terminal of the water cooling jacket (if present) before connecting up the instrument (see "Potential equalization", → 16).
- ▶ Connect protective earth to the protective earth terminal.
- ▶ According to IEC/EN 61010 a suitable power switch has to be provided for the instrument.
- ▶ The cable isolations must comply with the supply voltage and the overvoltage category.
- ▶ The temperature resistance of the connecting cable must comply with the ambient temperature.

The procedure

1. Using a 3 mm Allen key, loosen the cover clamp for the connection compartment cover.
2. Unscrew the cover of the terminal compartment.
3. Push the power cable and (if required) the signal cable) through the appropriate cable glands or cable threads.
4. Wire up according to the terminal assignment diagram.
5. Tighten the cable glands or threads.
6. Screw the cover securely back onto the terminal compartment..
7. Adjust the cover clamp so it is set over the cover and tighten.

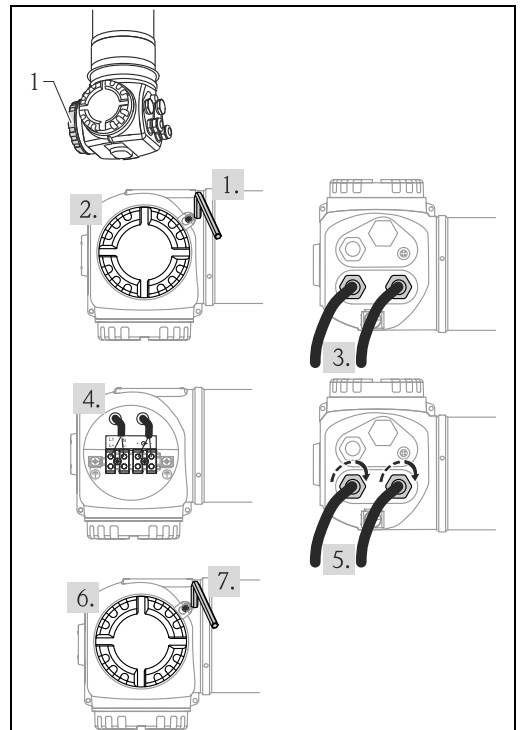

A0019826

3.5 Wiring in terminal compartment 2

⚠ CAUTION

Before connection please note the following:

- ▶ Connect potential matching line to transmitter ground terminal and to the ground terminal of the water cooling jacket (if present) before connecting up the instrument ("Potential equalization", → 16).
- ▶ The cable isolations must comply with the supply voltage and the overvoltage category.
- ▶ The temperature resistance of the connecting cable must comply with the ambient temperature.

The procedure

1. Unscrew the cover of the terminal compartment.
2. Push the following cables through the appropriate cable glands or threads:
 - signal cable (if the signal output is located in terminal compartment 2)
 - PT-100 cable (if present)
 - cascading cables (input and/or output, if required)
3. Wire up according to the terminal assignment diagram.
4. Tighten the cable glands or threads.
5. Screw the cover securely back onto the terminal compartment.

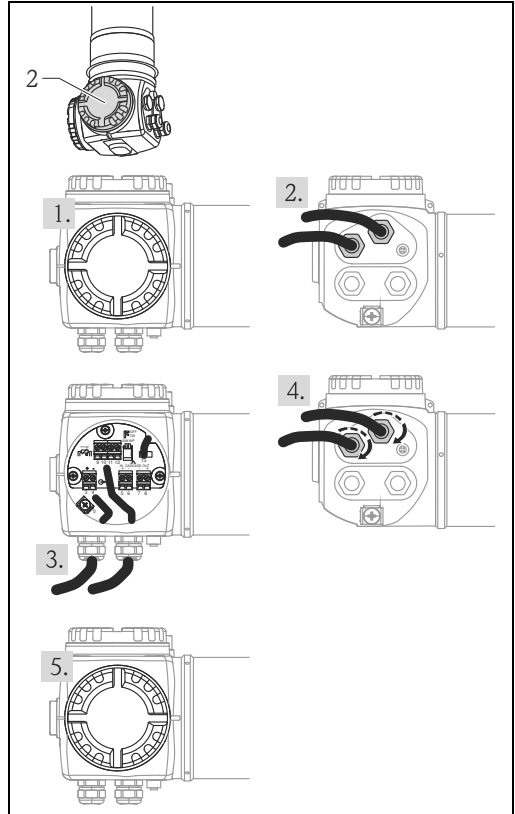

A0018927

3.6 Connecting the remote display and operation FHX40

The remote display and operating unit FHX40 is available as accessory. It is connected to the FHX40-connector of the Gammapilot M via the supplied cable. To do this, the housing of the Gammapilot M needs not to be opened.

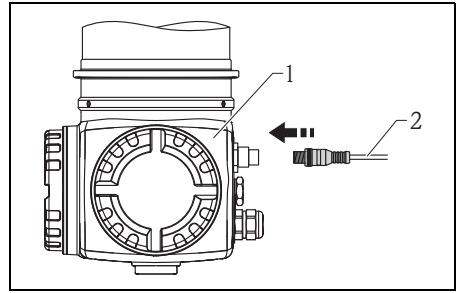

- 1 Gammapilot M FMG60
2 Cable of the display and operating unit FHX40

A0018089

For some Dust-Ex versions of the Gammapilot M, the FHX40 connector is protected by a metal sleeve.

1. Loosen and remove the sleeve with an Allen wrench.
2. Connect the display and operating unit FHX40
3. Attach the sleeve and fasten the Allen screw.

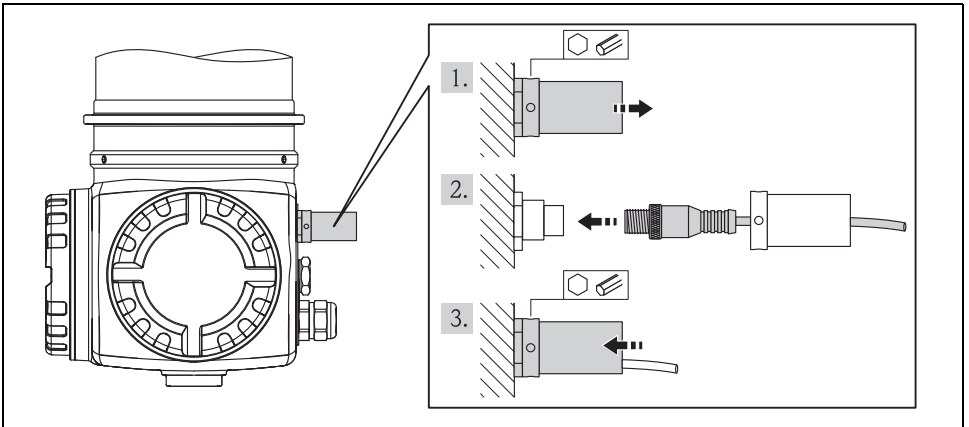

A0018090

3.7 Wiring in cascading mode

"Wiring in cascading mode", see BA00236F/00/EN.

3.8 Wiring example for point level detection 200/400mm

The output signal is linear between the free and covered calibration (e.g. 4 to 20 mA) and can be evaluated in the control system. If a relay output is needed, the following Endress+Hauser process transmitters can be used:

- RTA421: for non-Ex applications, without WHG, without SIL
- RMA42: for Ex-applications; with WHG and SIL certificates

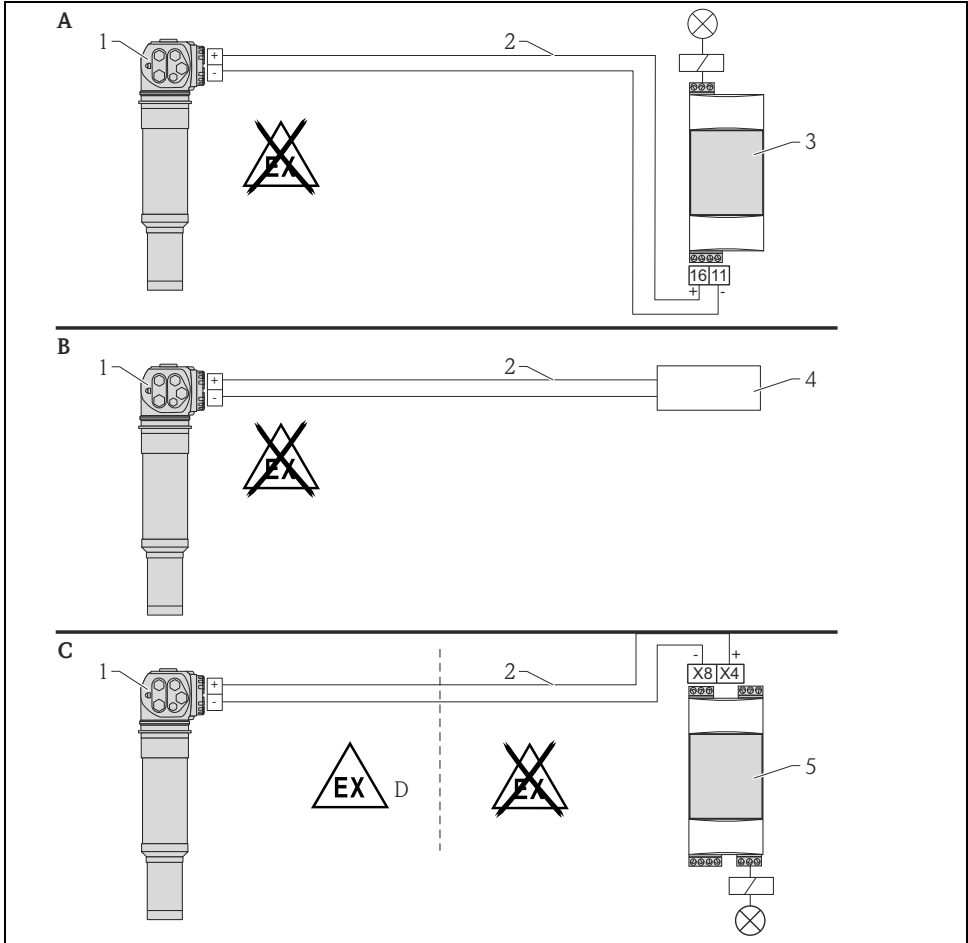

- A Wiring with RTA421 switching unit
- B Wiring with process control system
- C Wiring with RMA42 switching unit
- D When installing in hazardous areas, please observe the corresponding safety instructions

- 1 Gammapilot M
- 2 4 to 20 mA
- 3 RTA421
- 4 SPS
- 5 RMA42

A0018092

3.8.1 Ex applications in connection with RMA42

Observe the following Safety Instructions:

- XA00303F/00/A3: ATEX II 2 (1) G for Gammapilot M
- XA00304F/00/A3: ATEX II 2 (1) D for Gammapilot M
- XA00095R/09/A3: ATEX II (1) G [Ex ia] IIC, ATEX II (1) D [Ex ia] IIIC for RMA42

3.8.2 SIL applications for Gammapilot M FMG60 in conjunction with RMA42 (for point level detection 200/400 mm PVT scintillator)

- The Gammapilot M meets SIL2/3 as per IEC 61508, see:
 - Functional safety manual SD00230F/00/EN (Maximum point level detection)
 - Functional safety manual SD00324F/00/EN (Minimum point level detection)
- The RMA42 meets SIL2 as per IEC 61508:2010 (Edition 2.0), see functional safety manual SD00025R/09/EN.

3.9 Post-connection check

After wiring the device, carry out the following checks:

- Is the protective earth connected?
- Is the Potential Equalization Line connected?
- Are the terminals correctly assigned?
- Are the cable glands and dummy plugs tight?
- Are the fieldbus connectors and the FHX40 connector fixed securely?
- Are the lids screwed tightly onto the terminal compartments?
- For dust ignition-proof devices: Is the protective sleeve for the FHX40 socket correctly attached?
- Is the cover of the terminal compartment 1 secured by the cover clamp?

WARNING

The Gammapilot M may only be operated, if the cover of the terminal compartment 1 is tightly closed.

4 Operation

4.1 General structure of the operating menu

4.1.1 Function code

The functions of the GammapiLOT M are arranged in an operating menu. To ensure easy orientation within the menu, a unique position code is indicated on the display for each function. This code consists of one alphabetic and two numeric characters.

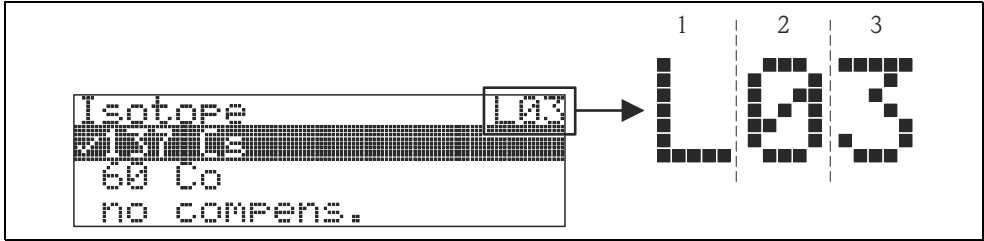

A00198/7/6-EN

- | | |
|---|----------------|
| 1 | Measuring mode |
| 2 | Function group |
| 3 | Function |

- The alphabetic character specifies the current measuring mode of the GammapiLOT M:
 - L: level
 - S: limit (switch)
 - D: density
 - C: concentration
 - *: no measuring mode selected yet
- The first numeric character identifies the function group:
 - **basic setup *0**
 - **calibration *1**
 - **Safety settings *2**
 - ...
- The second numeric character numbers the individual functions within the function group:
 - basic setup *0**
 - **today's date *01**
 - **beam type *02**
 - **isotope *03**
 - **operating mode *04**
 - ...

Hereafter, the position is always given in brackets after the function name. "*" (not yet selected) is always indicated as the measurement method, e.g. "**present date**" (*01).

4.2 Display and operating elements

The LCD module VU331 for displaying and operating is inside the remote display and operating unit FHX40. The measured value can be read off through the FHX40 sight glass. In order to operate the instrument, the FHX40 must be opened by removing the four screws.

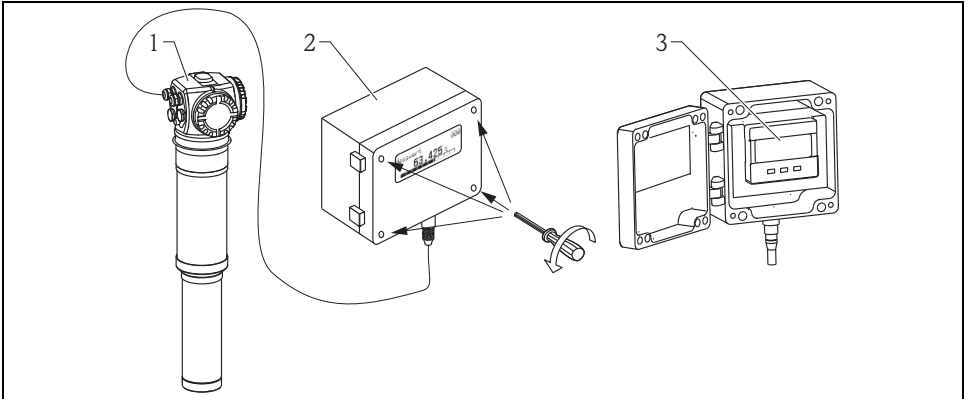

- 1 Gammapilot M
- 2 FHX40
- 3 Operating module VU331

A0018096

4.2.1 Display and operating module VU331

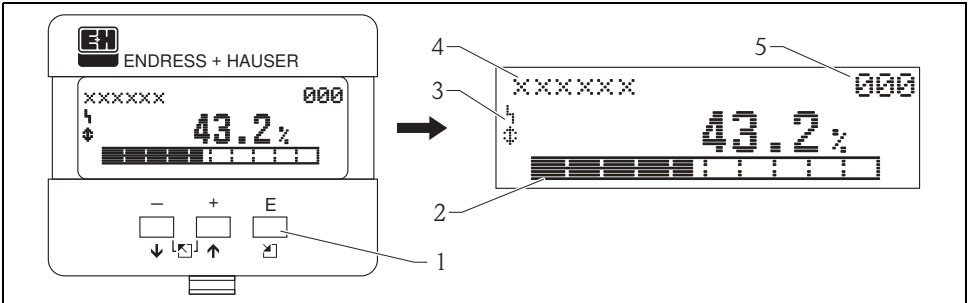





- 1 Operating keys
- 2 Bargraph
- 3 Symbols
- 4 Function name
- 5 Parameter Identification number















A0018097

4.2.2 Display symbols

The following table describes the symbols that appear on the liquid crystal display:

Symbol	Meaning
	ALARM_SYMBOL This alarm symbol appears when the instrument is in an alarm state. If the symbol flashes, this indicates a warning.
	LOCK_SYMBOL This lock symbol appears when the instrument is locked, i.e. if no input is possible.
	COM_SYMBOL This communication symbol appears when data transmission via HART, PROFIBUS PA or FOUNDATION Fieldbus, for example, is in progress.
	SIMULATION_SWITCH_ENABLE This communication symbol appears when simulation in FOUNDATION Fieldbus is enabled via the DIP switch.

4.2.3 Function of the keys

Key(s)	Meaning
 or 	Navigate upwards in the selection list. Edit numeric value within a function.
 or 	Navigate downwards in the selection list. Edit numeric value within a function.
 or 	Navigate to the left within a function group.
	Navigate to the right within a function group, confirmation.
 and  or  and 	Contrast settings of the LCD.
 and  and 	Hardware lock / unlock After a hardware lock, an operation of the instrument via display or communication is not possible! The hardware can only be unlocked via the display. An unlock parameter must be entered to do so.

5 Commissioning

5.1 Calibration: overview

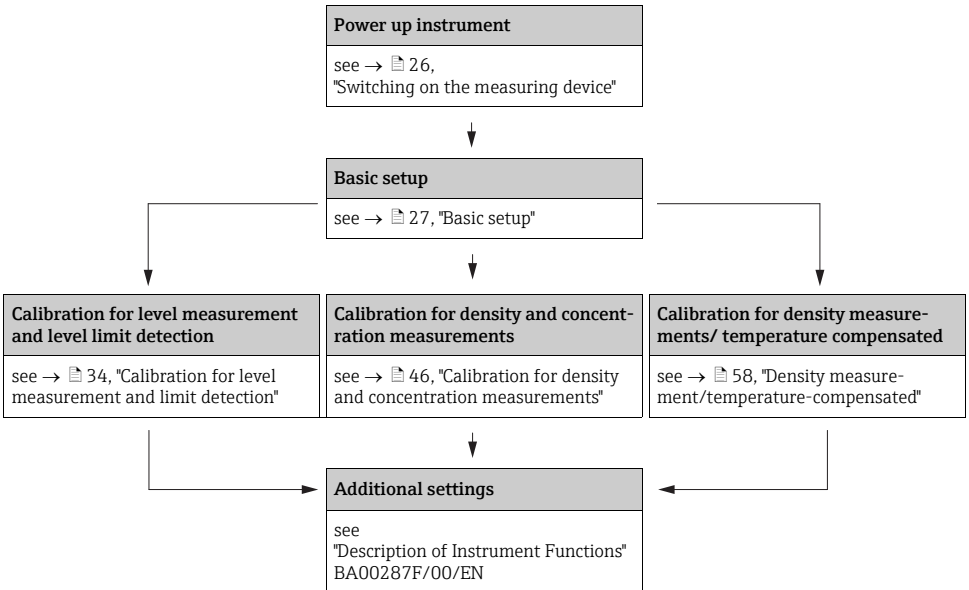

A detailed description of the functions used can be found in the following sections:

- 27, "Basic setup"
- 34, "Calibration for level measurement and limit detection"
- 46, "Calibration for density and concentration measurements"
- 58, "Density measurement/temperature-compensated"

5.2 Function check

Make sure that all final checks have been completed before you start up your measuring point:

- Checklist "Installation check", → 12.
- Checklist "Post-connection check", → 21.

5.3 Switching on the measuring device

After switching on the supply voltage, the instrument is first initialized. Due to internal memory tests, this takes approx. 2 minutes.

On-site display
FMG60
V01.03.06 HART

Meaning

Then, the following appear for approximately five seconds:

- Device type
- Software version
- Type of the communication signal

On first power up you are requested to select the language for the display texts.

Language	092
✓ Englisch	
Français	
Español	

Select the language with the and keys.
Confirm your choice by pressing twice.

Group selection
✓ Basic setup
Calibration
Safety settings

After that the measured value display appears. Now you can perform the basic setup and the calibration.
Press to switch to the group selection.

Press again to enter the first function of the "basic setup" function group.

5.4 Basic setup

5.4.1 Function "Present date" (*01)

On-site display	
Present date	*01
17.11.04	10:30
dd.mm.yy	hh:mm

Meaning

Date and time of the basic setup are specified in this function.

5.4.2 Function "Beam type" (*02)

On-site display	
Beam type	*02
<input checked="" type="checkbox"/> Standard/cont.	
<input type="checkbox"/> Modulated	

Meaning

This function is used to specify whether the radiation source used emits radiation continuously or whether it is modulated (for grammagraphy suppression).

- Standard/continuous (permanent, continuous radiation)
- Modulated (modulated radiation source)

5.4.3 Function "Isotope" (*03)

On-site display	
Isotope	*03
<input checked="" type="checkbox"/> 137 Cs	
<input type="checkbox"/> 60 Co	
<input type="checkbox"/> no compens.	

Meaning

This function is used to specify which isotope is used for the measurement. The Gammapilot M needs this information for the decay compensation.

5.4.4 Function "Operating mode" (*04)

On-site display	
Operating mode	*04
✓ Stand alone	
Master	
Slave	

Meaning

This function is used to specify in which operating mode the Gammapilot M will be used.

NOTICE

The selection can be performed only once and the function is automatically locked after that. It can only be unlocked again by a reset of the Gammapilot M ("Reset" (*A3) function).

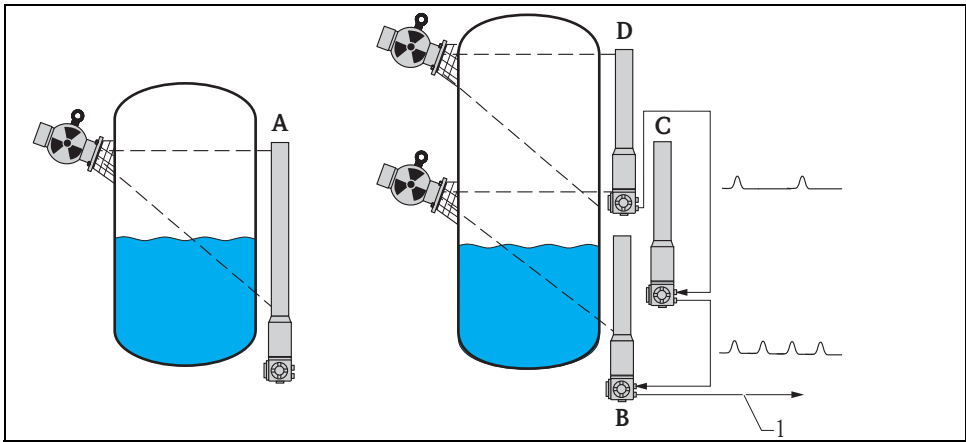

A0018107

- A One Gammapilot M is sufficient for measuring ranges up to 2 m (6.6 ft); For larger measuring ranges as many Gammapilot M as required can be connected (cascading mode). By Software settings they are defined as
- B Master
- C Slave(s) or
- D End-Slave
- 1 4 to 20 mA HART; PROFIBUS PA; FOUNDATION Fieldbus

Options/display:

- **Stand alone:** This option is selected if the Gammapilot M is used as a single instrument.
- **Master:** This option is selected if the Gammapilot is located at the beginning of a cascading chain. It receives pulses from a connected slave, adds its own pulses and calculates the measuring value from this total.
- **Slave:** This option is selected if the Gammapilot M is located in the middle of a cascading chain. It receives the pulses from an additional connected slave or end-slave, adds its own pulses and transmits this total to the next device (master or slave). After selecting this option, the basic setup is finished. When cascading several transmitters the further calibration is performed on the master only.
- **End slave:** This option is selected if the Gammapilot M is located at the end of a cascading chain. It does not receive pulses from another device but transmits its own pulses to the next device (master or slave). After selecting this option, the basic setup is finished. When cascading several transmitters the further calibration is performed on the master only.
- **Not defined:** Is displayed if no operating mode has been selected yet. In order to continue the basic setup, a selection is necessary.

NOTICE

If a "Slave" or an "End-slave" are connected to the "FieldCare", the pulse rate of this device is displayed in the header instead of the measured value.

5.4.5 Function "Meas. mode" (*05)

On-site display	
Meas. mode	*05
✓ Level	
Limit	
Density	

Meaning

This function is used to select the desired measuring mode.

Further options:

- Level measurement (continuous)
- Level limit detection
- Density measurement (with temperature compensation if required)
- Concentration measurement (density measurement followed by linearization)

NOTICE

The selection can be performed only once and the function is automatically locked after that. It can only be unlocked again by a reset of the Gammapilot M ("Reset" (*A3) function).

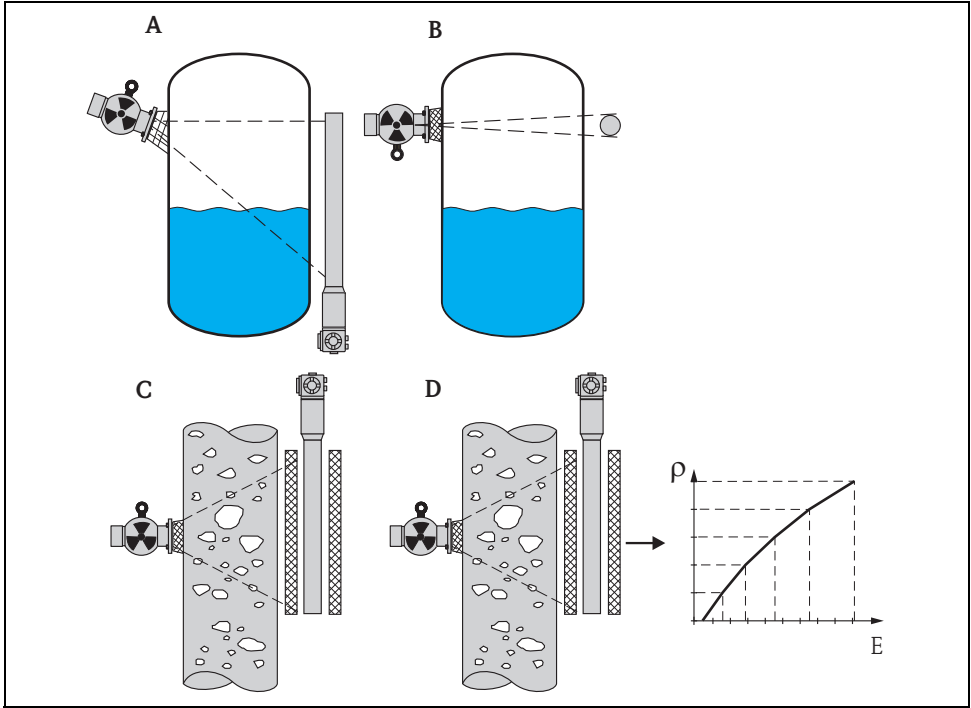

A0018108

- | | | | |
|---|---|--------|---------------|
| A | Level measurement (continuous) | ρ | Density |
| B | Level limit detection | E | Concentration |
| C | Density measurement (with temperature compensation if required) | | |
| D | Concentration measurement (density measurement followed by linearization) | | |

5.4.6 Function "Density unit" (*06)

On-site display	
Density unit	*06
✓ g/cm ³	
g/l	
lb/gal	

Meaning

This function is needed for density and concentration measurements only. It is used to select the density unit.

Further options:

- g/cm³
- g/l
- lb/gal; [1g/cm³ = 8,345 lb/gal]
- lb/ft³; [1g/cm³ = 62,428 lb/ft³]
- 1°Brix = [270 (1 - 1/x)]
- °Baumé; [1°Baumé = 144.3 (1 - 1/x)]
- °API; [1°API = 131.5 (1.076/x - 1)]
- °Twaddell; [1°Twaddell = 200 (x-1)]

"x" refers to the density in g/cm³. The formula indicates how many degrees this density corresponds to.

5.4.7 Function "Min. density" (*07)

On-site display	
Min. density	*07
0,9500 g/cm ³	

Meaning

This function is needed for density and concentration measurements only. It is used to specify the lower limit of the density range.

The output current for this density is 4 mA.

5.4.8 Function "Max. density" (*08)

On-site display	
Max. density	*08
1,2500 g/cm ³	

Meaning

This function is needed for density and concentration measurements only. It is used to specify the upper limit of the density range.

The output current for this density is 20 mA.

5.4.9 Function "Pipe diam. unit" (*09)

On-site display	
Pipe diam. unit	*09
✓ mm	
inch	

Meaning

This function is needed for density and concentration measurements only. It is used to select the unit for the pipe diameter.

1 inch = 25,4 mm

5.4.10 Function "Pipe diameter" (*0A)

On-site display	
Pipe diam.	*0A
200 mm	

Meaning

This function is needed for density and concentration measurements only. It is used to specify the irradiated measuring path L. With standard installation, this value is identical to the inner pipe diameter D_i . For other installations (in order to enlarge the irradiated measuring path) it may be larger (see figure). The pipe walls are **not** to be considered a part of the measuring path.

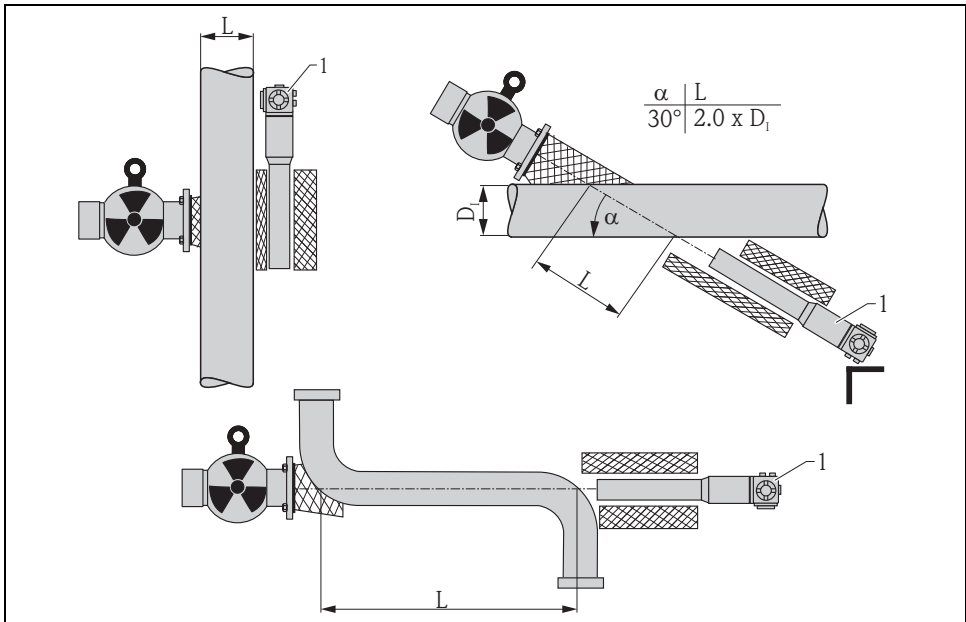

A0018109

Always specify the complete irradiated measuring path L in the 'pipe diameter' (*0A) function. Depending on the installation, this value may be larger than the actual pipe diameter.

5.4.11 Function "Output damping" (*0B)

On-site display	
Output damping	*0B
60 s	

Meaning

This function is used to specify the output damping τ (in seconds) by which changes of the measured value are attenuated. After a surge in the level or density it takes $5 \times \tau$ until the new measured value is reached.

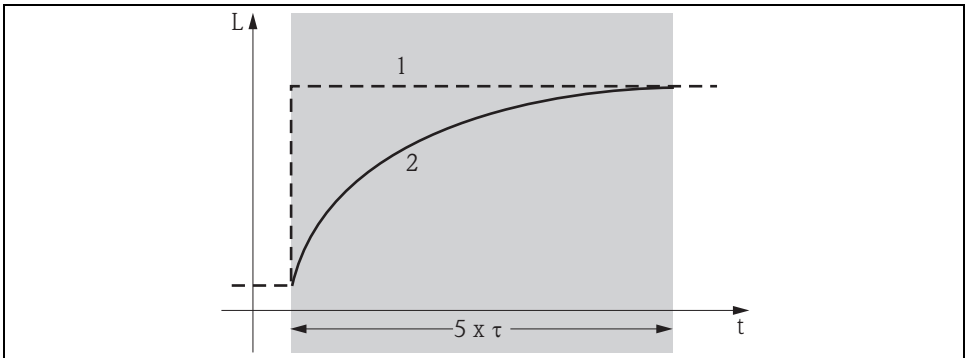

- 1 Level change (or density change)
- 2 Measured value

A0018110

Range of values

1 to 999 s

Default

The default depends on the selected "measuring mode" (*05):

- Level: 6 s
- Limit: 6 s
- Density: 60 s
- Concentration: 60 s

Selecting the output damping

The best value of the output damping depends on the process conditions. By enlarging the output damping, the measured value becomes considerably steadier but also slower. In order to dampen the influence of strongly fluctuating surfaces or stirrers, it is advisable to enlarge the output damping. On the other hand, if rapid changes of the measured value have to be detected accurately, the output damping may not be selected to large.

5.5 Calibration for level measurement and limit detection

5.5.1 Basic principles

The calibration points for the measurement are entered in the **"calibration" (*1)** function group. Each calibration point consists of a level and the associated pulse rate.

Calibration points for level measurement

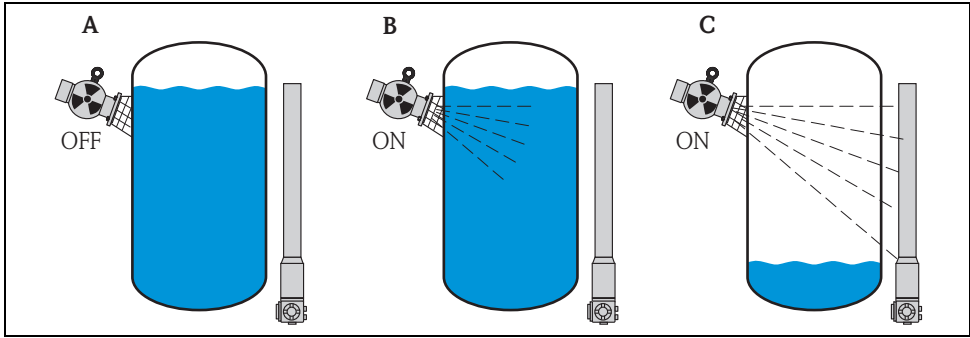

- A Background calibration
 B Full calibration
 C Empty calibration

A0018111

Background calibration

Refers to the following situation:

- The radiation is switched off.
- Within the measuring range, the vessel is filled as far as possible (ideally: 100%).

The background calibration is necessary, in order to register the natural background radiation at the mounting position of the Gammapilot M. The pulse rate of this background radiation is automatically subtracted from any other measured pulse rate. That means: only the part of the pulse rate which originates from the applied radiation source is taken into account and is displayed.

As opposed to the radiation of the applied source, the background radiation remains nearly constant during the complete measurement. Therefore, it is not submitted to the automatic decay compensation of the Gammapilot M.

Full calibration

Refers to the following situation:

- The radiation is switched on.
- Within the measuring range, the vessel is filled as far as possible (ideally: 100%, minimum 60%).

If the vessel cannot be filled to at least 60% during the calibration, the full calibration can alternatively be performed with the radiation being switched off, which is a way of simulating a filling of 100%. In this case, the full calibration is identical to the background calibration. As the pulse rate of the background radiation is automatically subtracted, the displayed pulse rate is about 0 cps.

NOTICE

This type of simulated calibration is not possible with self-radiating media. In this case it is always necessary to perform the background and full calibration with the vessel filled to 100%.

Empty calibration

Refers to the following situation:

- The radiation is switched on.
- Within the measuring range, the vessel is emptied as far as possible (ideally: 0%, maximum 40%).

Calibration points for limit detection

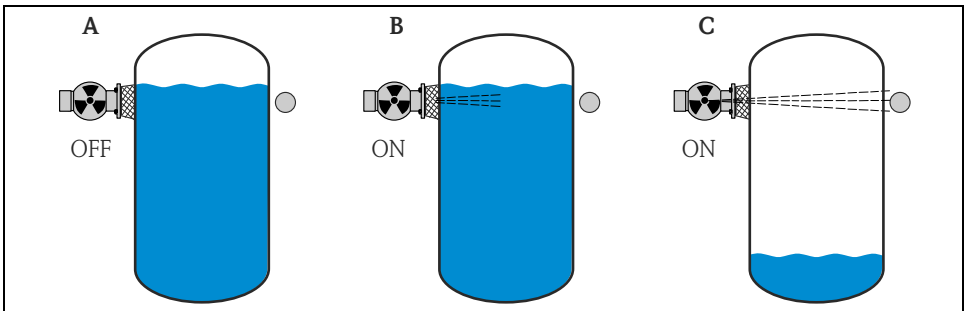

- A Background calibration
 B Covered calibration
 C Free calibration

A0018112

Background calibration

Refers to the following situation:

- The radiation is switched off.
- If possible, the radiation path is completely covered.

The background calibration is necessary, in order to register the natural background radiation at the mounting position of the Gammapiilot M. The pulse rate of this background radiation is automatically subtracted from any other measured pulse rate. That means: only the part of the pulse rate which originates from the applied radiation source is taken into account and is displayed.

As opposed to the radiation of the applied source, the background radiation remains nearly constant during the complete measurement. Therefore, it is not submitted to the automatic decay compensation of the Gammapiilot M.

Covered calibration

Refers to the following situation:

- The radiation is switched on.
- If possible, the radiation path is completely covered.

If the radiation path cannot be completely covered during the calibration, the covered calibration can alternatively be performed with the radiation being switched off, which is a way of simulating complete covering. In this case, the covered calibration is identical to the background calibration. As the pulse rate of the background radiation is automatically subtracted, the displayed pulse rate is about 0 c/s.

NOTICE

This type of simulated calibration is not possible with self-radiating media. In this case it is always necessary to perform the background calibration and the covered calibration with the radiation path completely covered.

Free calibration

Refers to the following situation:

- The radiation is switched on.
- The radiation path is completely free.

Methods for entering the calibration points

Automatic calibration

For an automatic calibration, the vessel is filled to the required value. For the background calibration the radiation remains switched off, for the other calibration points the radiation is switched on. The Gammapilot M automatically records the pulse rate. The associated level is entered by the user.

Manual calibration

If during the commissioning of the Gammapilot M one or more calibration points cannot be realized (e.g. because the vessel cannot be sufficiently filled or emptied), the calibration point must be entered manually.

That is, not only the level but also the associated pulse rate must be entered by the user.

For details concerning the calculation of the count rate please refer to your Endress+Hauser sales organization.

NOTICE

Calibration date and calibration

- ▶ When calibrating manually, the calibration date is not set automatically. Instead, it must be entered manually into the "**calibration date**" (***C7**) function.
- ▶ A manually entered calibration point should be replaced by an automatic calibration as soon as the associated level occurs during the operation of the plant. This recalibration is advisable because calibration points entered automatically result in more precise measurement results than calculated ones.

5.5.2 Background calibration

Excerpt from the operating menu

The following excerpt from the operating menu shows how the background calibration is entered. The individual functions are explained in the sections below.

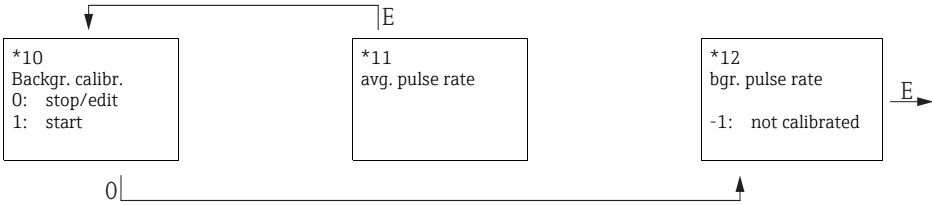

Function "Backgr. cal." (*10)

On-site display	
Backgr. cal.	*10
stop/edit	
start	

Meaning

This function is used to start the background calibration.

Options:

■ stop/edit

This option must be selected if

- No background calibration is to be performed but the pulse rate of an existing background calibration is to be displayed instead.
- A manual background calibration is to be performed.

After selecting this option, the Gammapiot M changes to the **"bgr. pulse rate" (*12)** function, where the existing pulse rate is displayed and can be changed if required.

■ start

This option is used to start an automatic background calibration. The Gammapiot M changes to the **"avg. pulse rate" (*11)** function.

Function "Avg. pulse rate" (*11)

On-site display	
Avg. pulse rate	*11
186 cps	

Meaning

The average pulse rate is displayed in this function (after selection of "start" in the previous function). Initially, this value fluctuates (because of the decay statistics), but due to the integration it reaches an average value in the course of time. The longer the averaging is performed the lower are the remaining fluctuations.

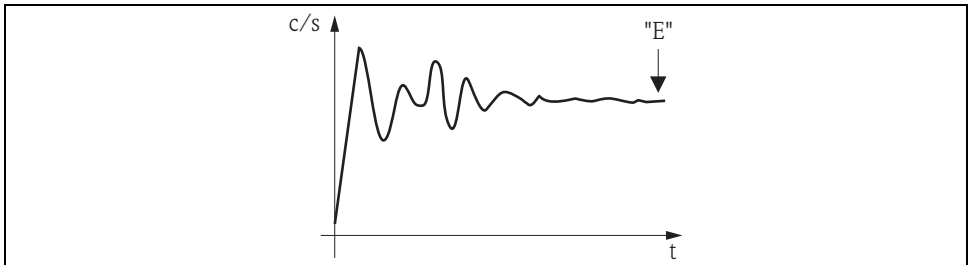

A0018118

If the value is sufficiently stable, the function can be left by pressing "E".

Thereafter, the Gammapilot M changes to the "**backgr. calib.**" (*10) function. Select "**stop/edit**" to stop the averaging procedure. The value is then automatically transmitted to the "**bgr. pulse rate**" (*12) function.

NOTICE

Bgr. pulse rate

- ▶ The maximum integration time is 1000 s. After this time, the value is automatically transmitted to the "**bgr. pulse rate**" (*1B) function.
- ▶ The integration is **not** terminated by pressing "E" in the "**avg. pulse rate**" (*11) function. It is continued until the selection of "**stop/edit**" in the "**backgr. calib.**" (*10) function. This may result in a slight deviation between the last displayed average pulse rate and the final "**bgr. pulse rate**" (*12).

Function "Background pulse rate" (*12)

On-site display	
Backgr. pulse rate	*12
186 cps	

Meaning

The pulse rate of the background calibration is displayed in this function. By pressing "E" the displayed value can be confirmed and the background calibration completed. "-1" indicates, that no background calibration is present yet. In this case there are two options:

- Either return to the "background calibration" (*10) function and restart the background calibration
- Or enter a known or calculated pulse rate (manual calibration). Thereafter, the GammapiLOT M changes to the "calibr. point" (*13) or (*1A) function.

5.5.3 Full and empty calibration or covered and free calibration

Excerpt from the operating menu

The following excerpt from the operating menu shows how the full and empty calibration (for level measurements) or the covered and free calibration (for level limit detection) are entered. The individual functions are explained in the sections below.

The functions are only accessible after the background calibration has been performed.

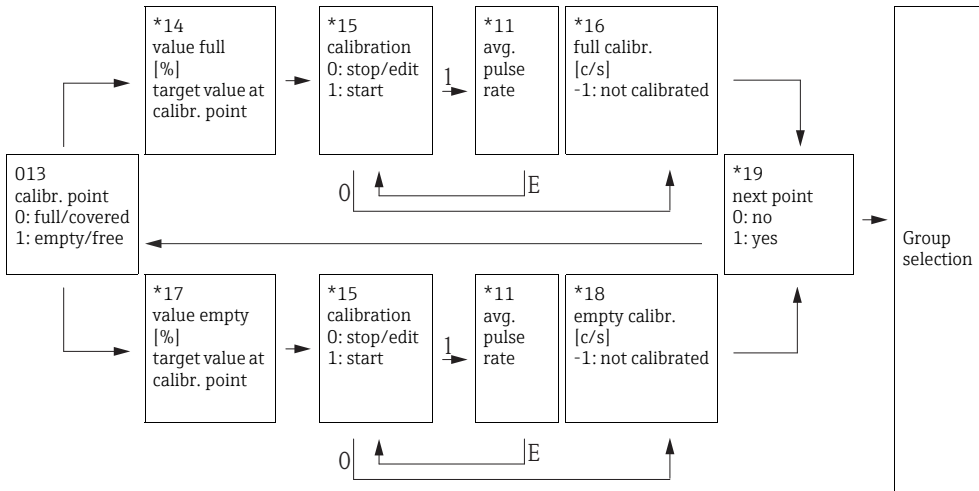

NOTICE

The "value full" (*14) and "value empty" (*17) functions only appear if the "level" option was selected in the "measurement method" function (*05).

Function "Calibration point" (*13)

On-site display	
Calibr. point	*13
✓ full/covered	
empty/free	

Meaning

This function is used to select which calibration point ("full/covered" or "empty/free") will be entered.

Function "Value full" (*14) / Function "Value empty" (*17)

On-site display	
value full	*14
100%	

Meaning

These functions are needed for level measurements only. They are used to specify the level at which the full or empty calibration are performed.

value empty	*17
0%	

Range of values

	optimum value	minimum value	maximum value
Value full (*14)	100%	60%	100%
Value empty (*17)	0%	0%	40%

Function "Calibration" (*15)

On-site display	
calibration	*15
stop/edit	
start	

Meaning

This function is used to start the automatic entering of the selected calibration point.

Options:

■ stop/edit

This option must be selected if

- the calibration point is not to be entered (e.g. because it has already been entered). The pulse rate of the calibration point is then displayed in the following function, **"full calibr." (*16)** or **"empty calibr." (*18)**. If required, this value can be changed.
- the calibration point is to be entered manually. This can be done in the following function, **"full calibr." (*16)** or **"empty calibr." (*18)**.

■ start

This option is used to start the automatic entering of the calibration point. The Gammapilot M then changes to the **"avg. pulse rate" (*11)** function.

Function "Avg. pulse rate" (*11)

On-site display	
avg. pulse rate	*11
2548 cps	

Meaning

The average pulse rate is displayed in this function (after selection of "start" in the previous function). Initially, this value fluctuates (because of the decay statistics), but due to the integration it reaches an average value in the course of time. The longer the averaging is performed the lower are the remaining fluctuations.

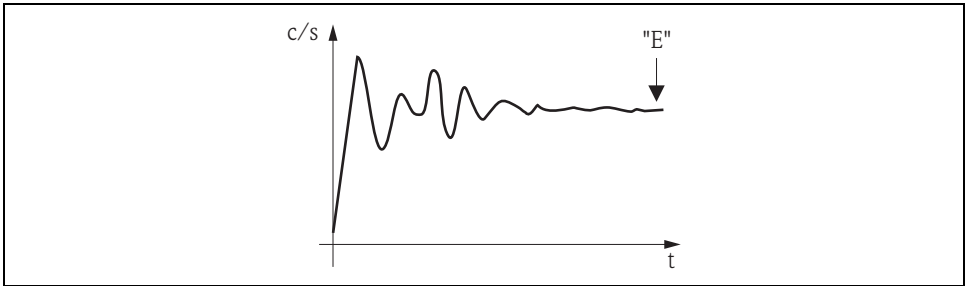

Initially, the pulse rate strongly fluctuates. In the course of time an average value is reached.

A0018118

If the value is sufficiently stable, the function can be left by pressing "E".

Thereafter, the Gammapilot M changes to the **"calibration" (*15)** function. Select **"stop/edit" (*16)** or **"empty calibr." (*18)** function respectively.

NOTICE

Avg. Pulse rate

- ▶ The maximum integration time is 1000 s. The value is then transmitted automatically to the **"full calibr." (*16)** or **"empty calibr." (*18)** function.
- ▶ The integration is **not** terminated by pressing "E" in the **"avg. pulse rate" (*11)** function. It is continued until the selection of **"stop/edit" (*15)** function. This may result in a slight deviation between the last displayed average pulse rate and the final **"full calibr." (*16)** or **"empty calibr. (*18)**.

Function "Full calibration" (*16) / Function "Empty calibration" (*18)

On-site display	
full calibr. 33 cps	*16

Meaning

The pulse rate of the respective calibration points is displayed in these functions. The displayed value must be confirmed by pressing "E". "-1" indicates, that no background calibration is present yet.

In this case there are two options:

- either return to the "calibration" (*15) function and restart the calibration
- or enter a known or calculated pulse rate (manual calibration)

empty calibr. 2548 cps	*18
---------------------------	-----

Function "Next point" (*19)

On-site display	
next point	*19
<input checked="" type="checkbox"/> no	
<input type="checkbox"/> yes	

Meaning

This function is used to specify, if a further calibration point is to be entered or not.

Options:

▪ no

This option must be selected after both calibration points have been entered. After this selection the Gammapiot M returns to the group selection and the calibration is completed.

▪ yes

This option must be selected, if only one calibration point has been entered yet. After this selection the Gammapiot M returns to the "calibr. point" (*13) function and the next point can be entered.

5.5.4 Additional settings

After the calibration has been finished, the Gammapilot M outputs the measuring value via the current output and via the HART signal. The complete measuring range (0 to 100%) is mapped to the range (4 to 20 mA) of the output current.

Many additional functions are available for optimizing the measuring point. They can be configured as required. A detailed description of all instrument functions is given in Operating Instructions BA00287F/00/EN, "Gammapilot M - Description of Device Functions". This document can be found on the supplied CD-ROM.

5.5.5 Configuration of the contactor for point level detection



For safety-related applications, the threshold values in the Safety Manual SD00230F/00/EN and SD00324F/00/EN must be observed.

The calculation of the switching signal from the continuous signal is not performed within the Gammapilot M but in the connected evaluation unit or process transmitter. For further information refer to the Operating Instructions of the respective instrument.

If using the Endress+Hauser process transmitter RTA421 or RMA42 the following settings are recommended:

For maximum fail-safe mode

- Switch threshold (SETP) = 75%
- Hysteresis (HYST) = 50%

5.6 Calibration for density and concentration measurements

5.6.1 Basic principles

The calibration points for the measurement are entered in the "calibration" (*1) function group. Each calibration point consists of a density value and the associated pulse rate.

Calibration points for density and concentration measurements

Function of the calibration points

For density and concentration measurements the Gammapilot M needs (apart from the length of the irradiated measuring path) the following two parameters:

- The absorption coefficient μ of the material measured
- The reference pulse rate I_0 ⁵⁾.

It calculates these parameters automatically from the following calibration points:

- Background calibration (calibration with the radiation switched off)
- Up to nine calibration points for samples of various known densities.

NOTICE

With self-radiating media it is always necessary to perform the background calibration with a filled pipe. A simulated calibration with an empty pipe is not possible in this case.

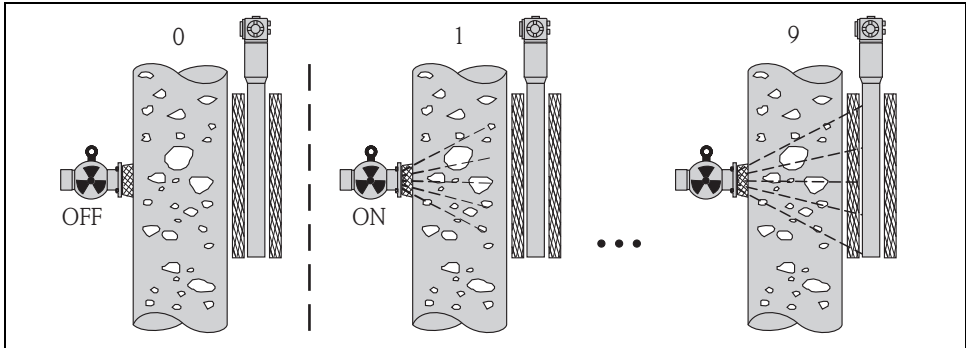

0 Background calibration

1-9 Calibration points for various densities

A0018128

5) I_0 is the pulse rate for the tube being empty. The value is significantly higher than any real pulse rate occurring during the measurement.

Two-point calibration

The recommended comparison procedure for high exactness standards about the whole measuring range is the two-point calibration. First the background calibration occurs. The two calibration points will be adapt. They should differ considerably. After input of both calibration points, the Gammapilot M calculates the parameters I_0 und μ .

One-point calibration

If a two-point calibration is not possible, a one-point calibration can be carried out. That means, that apart from the background calibration only one further calibration point is used. This calibration point should be located as near as possible to the operating point. Densities in the proximity of this operating point are measured fairly precisely, whereas the precision may decrease with increasing distance to the operating point. In one-point calibration, the Gammapilot M only calculates the reference pulse rate I_0 . For the absorption coefficient it uses the standard value $\mu = 7.7 \text{ mm}^2/\text{g}$ in this instance.

Multiple-point calibration

The multiple-point calibration is recommended particularly for measurements in a large density area or for especially exact measurements. Up to 9 calibration points can be used about the whole measuring range. The calibration points should be located as far from each other as possible and should be uniformly distributed over the measuring range. After the calibration points have been entered, the Gammapilot M automatically calculates the parameters I_0 und μ . Multiple-point calibration is especially advisable for measurement in a wide range of densities or for especially precise measurements.

Recalibration

The Gammapilot M provides a further calibration point ("10") for recalibration. This point can be entered, if the measuring conditions have changed, e.g. by deposit in the measuring tube. After entering of the recalibration point, I_0 is recalculated according to the current measuring conditions. The absorption coefficient μ is kept unchanged from the original calibration.

Methods for entering the calibration points

Automatic calibration

For an automatic calibration, the desired calibration point is realized at the measuring tube, i.e. the measuring tube is filled with a medium of the desired density. For the background calibration the radiation remains switched off, for the other calibration points the radiation is switched on. The Gammapilot M automatically records the pulse rate. The associated density is determined in the laboratory and entered by the user.

Manual calibration

In order to achieve a high measuring accuracy, it is advisable to determine the pulse rates for a couple of samples of the same density and to calculate the average density and average pulse rate for these samples. These values can then be entered manually into the Gammapilot M. If possible, this procedure should be repeated at a further density. The both density values should be as far from each other as possible.

NOTICE

When calibrating manually, the calibration date is not set automatically. Instead, it must be entered manually into the "calibration date" (*C7) function.

5.6.2 Background calibration

Excerpt from the operating menu

The following excerpt from the operating menu shows how the background calibration is entered. The individual functions are explained in the sections below.

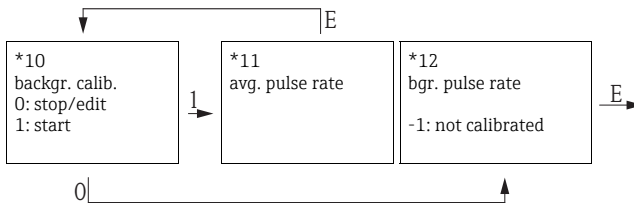

Function "Background calibration" (*10)

On-site display	
backgr. cal.	*10
stop/edit	
start	

Meaning

This function is used to start the background calibration.

Options:

■ stop/edit

This option must be selected if

- no background calibration is to be performed but the pulse rate of an existing background calibration is to be displayed instead.
- a manual background calibration is to be performed.

After selecting this option, the Gammapilot M changes to the "**bgr. pulse rate**" (*12) function, where the existing pulse rate is displayed and can be changed if required.

■ start

This option is used to start an automatic background calibration. The Gammapilot M changes to the "**avg. pulse rate**" (*11) function.

Function "Avg. pulse rate" (*11)

On-site display	
avg. pulse rate	*11
186 cps	

Meaning

The average pulse rate is displayed in this function (after selection of "start" in the previous function). Initially, this value fluctuates (because of the decay statistics), but due to the integration it reaches an average value in the course of time. The longer the averaging is performed the lower are the remaining fluctuations.

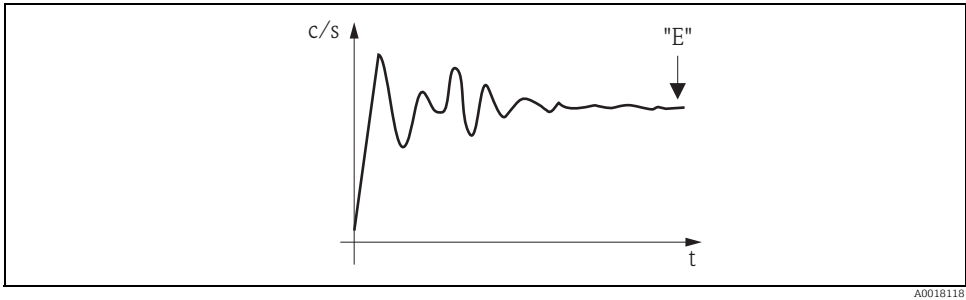

If the value is sufficiently stable, the function can be left by pressing "E". Thereafter, the Gammapilot M changes to the **"backgr. calib." (*10)** function. Select **"stop/edit"** to stop the averaging procedure. The value is then automatically transmitted to the **"bgr. pulse rate" (*12)** function.

NOTICE

Bgr. Pulse rate

- ▶ The maximum integration time is 1000 s. After this time, the value is automatically transmitted to the **"bgr. pulse rate" (*1B)** function.
- ▶ The integration is **not** terminated by pressing "E" in the **"avg. pulse rate" (*11)** function. It is continued until the selection of **"stop/edit"** in the **"backgr. calib." (*10)** function. This may result in a slight deviation between the last displayed average pulse rate and the final **"bgr. pulse rate" (*12)**.

Function "Background pulse rate" (*12)

On-site display	
backgr. pul. rate	*12
186 cps	

Meaning

The pulse rate of the background calibration is displayed in this function. By pressing "E" the displayed value can be confirmed and the background calibration completed. "-1" indicates, that no background calibration is present yet. In this case there are two options:

- either return to the **"background calibration" (*10)** function and restart the background calibration
- or enter a known or calculated pulse rate (manual calibration). Thereafter, the Gammapilot M changes to the **"calibr. point" (*13)** or **(*1A)** function

5.6.3 Calibration points

Excerpt from the operating menu

The following excerpt from the operating menu shows, how the density calibration points are entered. The individual functions are explained in the sections below. The functions are only accessible after the background calibration has been performed.

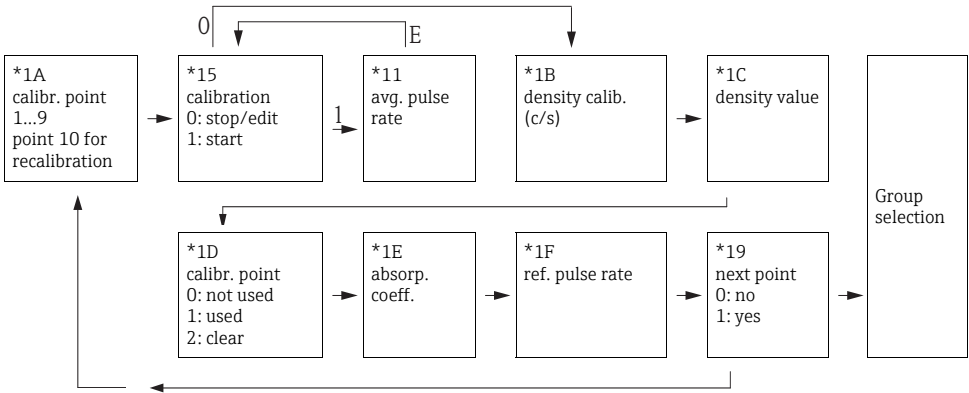

Function "Calibr. point" (*1A)

On-site display	
calibr. point	*1A
✓ 1	
2	
3	

Meaning

This function is used to select, which calibration point will be entered.

Further options:

- "1" to "9" : Calibration points for various densities
- "10": recalibration point

After entering of the recalibration point, I_0 is recalculated according to the current measuring conditions. The absorption coefficient μ is kept unchanged from the original calibration. The calibration point "10" can be entered if the measuring conditions have changed, e.g. due to buildup in the measuring tube.

Function "Calibration" (*15)

On-site display	
calibration	*15
stop/edit	
start	

Meaning

This function is used to start the automatic entering of the selected calibration point.

Options:

■ stop/edit

This option must be selected if

- the calibration point is not to be entered (e.g. because it has already been entered). The pulse rate of the calibration point is then displayed in the following function "**density calib.**" (*1B). If required, this value can be changed.
- the calibration is to be entered manually. For this purpose, the Gammapilot M changes to the "**density calib.**" (*1B) function.

■ start

This option is used to start the automatic entering of the calibration point. The Gammapilot M then changes to the "**avg. pulse rate**" (*11) function.

Function "Avg. pulse rate" (*11)

On-site display	
avg. pulse rate	*11
1983 cps	

Meaning

The average pulse rate is displayed in this function (after selection of "start" in the previous function). Initially, this value fluctuates (because of the decay statistics), but in the course of time it reaches an average value. The longer the averaging is performed the lower are the remaining fluctuations.

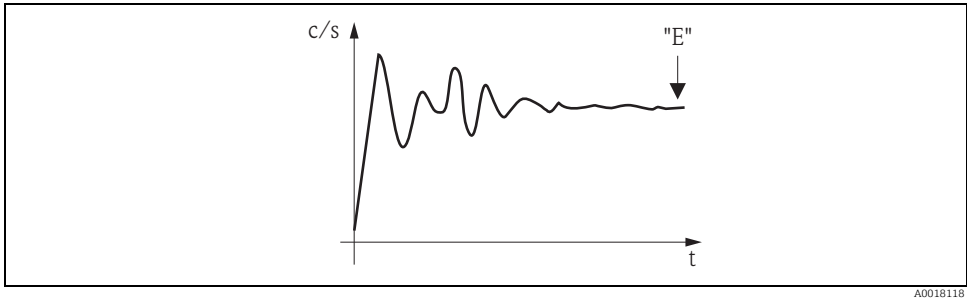

If the value is sufficiently stable, the function can be left by pressing "E".

Thereafter, the Gammapiot M changes to the **"calibration" (*15)** function. Select **"stop/edit"** to stop the averaging procedure. The value is then automatically transmitted to the **"density calibr." (*1B)** function.

NOTICE

Density calibration

- ▶ The maximum integration time is 1000 s. After this time, the value is automatically transmitted to the **"density calibration" (*1B)** function.
- ▶ During the integration a sample of the measured material must be taken. Its density must be determined in the laboratory).
- ▶ The integration is **not** terminated by pressing "E" in the **"avg. pulse rate" (*11)** function. It is continued until the selection of **"stop/edit"** in the **"calibration" (*15)** function. This may result in a slight deviation between the last displayed average pulse rate and the final **"density calibration" (*1B)**.

Function "Density calibration" (*1B)

On-site display	
density calibr.	*1B
1983 cps	

Meaning

The pulse rate of the respective calibration point is displayed in this function. The display value must be confirmed by pressing "E". "-1" indicates, that no pulse rate is present yet. In this case there are two options:

- either return to the "calibration" (*15) function and restart the calibration
- or enter a known or calculated pulse rate (manual calibration)

Function "Density value" (*1C)

On-site display	
density value	*1C
0.9963 g/cm ³	

Meaning

This function is used to enter the density of the calibration point. The value must be determined from the sample in a laboratory measurement.

NOTICE

When entering the value, temperature influences have to be taken into account. The density entered must refer to the temperature at which the pulse rate has been determined. If the density and the pulse rate have been determined at different temperatures, the density value must be corrected accordingly.

Function "Calibration point" (*1D)

On-site display	
calibr. point	*1D
not used	
✓ used	
clear	

Meaning

This function is used to specify, if the current calibration point is to be used.

Options:

- **not used**

The calibration point is **not** used. However, it can be reactivated at a later point of time.

- **used**

The calibration point is used.

- **clear**

The calibration point is deleted. It cannot be reactivated at a later point of time.

Function ""Absorp. coeff." (*1E)

On-site display	
absorp. coeff.	*1E
7.70 mm ² /g	

Meaning

This function displays the absorption coefficient which results from the currently active calibration points. The displayed value should be used for plausibility checking.

NOTICE

If only one calibration point is currently active, the absorption coefficient is not calculated. The last valid value is used instead. At the first commissioning or after a reset, the default value, $\mu = 7.70 \text{ mm}^2/\text{g}$, is used. The value can be changed by the user.

Function "Ref. pulse rate" (*1F)

On-site display	
ref. pulse rate	*1F
31687 cps	

Meaning

This function displays the reference pulse rate I_0 , which results from the currently active calibration points. The value cannot be edited.

NOTICE

I_0 is the pulse rate for the tube being empty (theoretical reference value). Generally, the value is significantly higher than any real pulse rate occurring during the measurement.

Function "Next point" (*19)

On-site display	
next point	*19
✓ no	
yes	

Meaning

This function is used to specify, if a further calibration point is to be entered or not.

Options:

- **no**
This option must be selected if no further calibration point is to be entered or changed. After this selection the Gammapilot M returns to the group selection and the calibration is completed.
- **yes**
This option must be selected, if a further calibration point is to be entered or changed. The Gammapilot M returns to the **"calibr. point" (*1A)** function and the next point can be entered or changed.

5.6.4 Linearization (for concentration measurements)

If the concentration is to be measured in a unit other than the **"density unit" (*06)**, a linearization must be performed after the calibration. This can be done in the **"Linearization" (*4)** function group. The functions of this group and the linearization procedure are described in Operating Instructions BA00287F/00/EN, "Gammapilot M - Description of Device Functions". This document can be found on the supplied CD-ROM.

5.6.5 Additional settings

After the calibration has been finished, the Gammapilot M outputs the measuring value via the current output and via the HART signal. The complete measuring range [min. density (*07) to max. density (*08)] is mapped to the current range 4 to 20 mA.

Many additional functions are available for optimizing the measuring point. They can be configured as required. A detailed description of all instrument functions is given in Operating Instructions BA00287F/00/EN, "Gammapilot M - Description of Device Functions". This document can be found on the supplied CD-ROM.

5.7 Density measurement/temperature-compensated

Perform density measurement as described in the section "Calibration for density and concentration measurements" and then perform temperature calibration (see "Temperature compensation" section in BA00287F/00/EN "Gammapilot M - Description of Device Functions").

5.8 Gammagraphy detection

See "Gammagraphy" section in BA00287F/00/EN "Gammapilot M - Description of Device Functions".

5.9 SIL locking (for point level detection 200/400 mm PVT scintillator)

"SIL locking (for point level detection 200/400 mm PVT scintillator)", see BA00236F/00/EN.



71207228

www.addresses.endress.com
