

Technical Information

RIA16

Field indicator

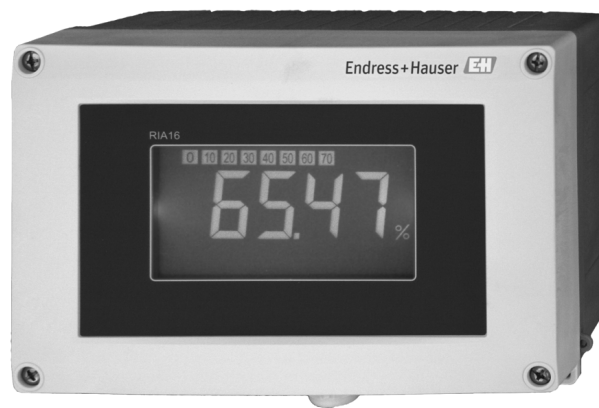

Loop-powered field indicator for looping into the 4 to 20 mA current circuit

Application

- Oil & gas
- Petrochemical industry
- System and apparatus engineering
- Outdoor applications
- Laboratory facilities
- Process data acquisition and monitoring
- Optional: aluminum housing for Ex application

Your benefits

- Loop-powered indicator
- 5-digit LC display, character height 26 mm (1.02")
- Trend bargraph in increments of 10%
- Measuring range display from -19999 to 99999
- Digital limit switch
- Freely programmable units
- 3-key operation
- Approvals: ATEX, FM, CSA, GL
- Configuration with FieldCare PC software
- Configuration without power supply using setup box

Function and system design

Measuring principle

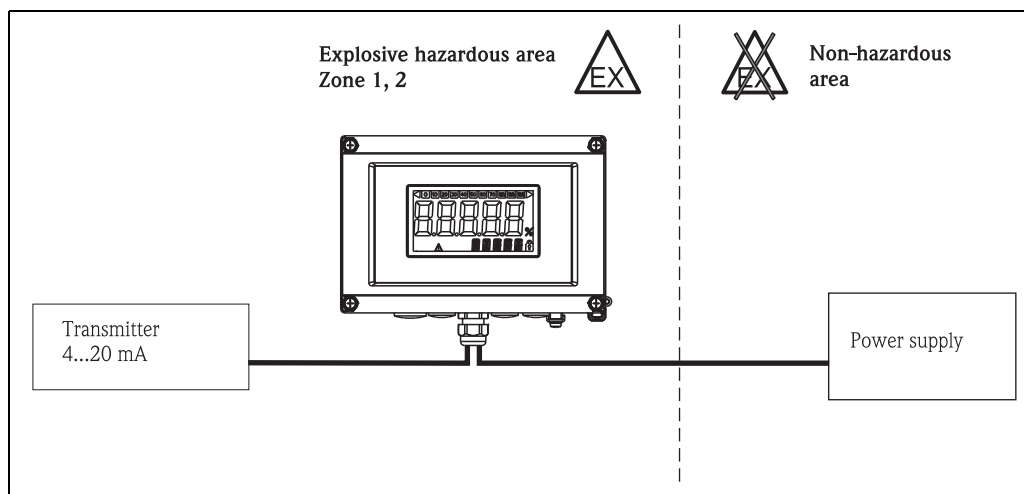

Example of an application of the field indicator

The indicator records an analog measuring signal and shows this on the display. The LC display shows the current measured value digitally and as a bargraph with limit value violation signalling. The indicator is looped into the 4 to 20 mA circuit and obtains the required energy from there.

Measuring system

Microcontroller controlled indicator in single chamber field housing with illuminated LC display. The measuring range, decimal point and offset of the indicator can be configured comfortably by means of three keys in the device with the housing open or by means of a PC with the FieldCare PC software.

Input

Measured variable	Current
Measuring range	4 to 20 mA (reverse polarity protection)
Input	<ul style="list-style-type: none"> ▪ Line voltage drop < 4 V at 3 - 22 mA ▪ Max. line voltage drop < 6 V at max. short-circuit current 200 mA

Output

Output	Digital limit switch Passive, open collector: $I_{\max} = 200 \text{ mA}$ $U_{\max} = 35 \text{ V}$ $U_{\text{low/max}} = < 2 \text{ V at } 200 \text{ mA}$ Max. reaction time to limit value = 250 ms Temperature range: -20 to +80 °C (-4 to +176 °F)
Signal on alarm	<ul style="list-style-type: none"> ▪ No measured value visible on the LC display, no background illumination. ▪ Open Collector inactive.
Transmission behavior	The indicator allows the HART [®] transmission protocol to pass unimpeded.

Power supply

Electrical connection

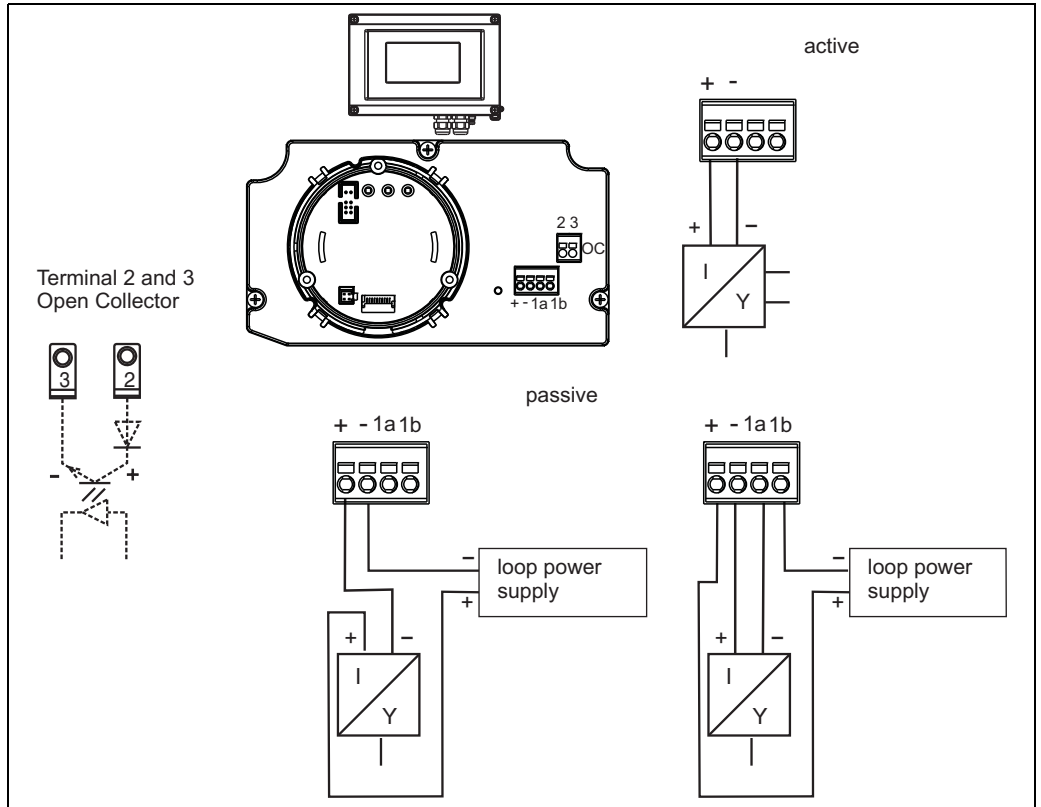

Terminal assignment of field indicator

Terminal	Terminal assignment	Input and output
+	Measuring signal (+) 4 to 20 mA	Signal input
-	Measuring signal (-) 4 to 20 mA	Signal input
1a, 1b	Terminal for further instrumentation	Support terminal
2	Digital limit switch (collector)	Switch output
3	Digital limit switch (emitter)	Switch output

Supply voltage

Supply by means of the 4 to 20 mA current loop.

Cable entry

The following cable entries are available:

- 2x thread NPT1/2
- 2x thread M16



The plastic housing provides up to 5 cable entries. Ex works, 3 of them remain closed. You can open the cable entries using a suitable tool.

The aluminum housing also provides 5 cable entries, 3 of which are closed with blind plugs.

Performance characteristics

Reference operating conditions	T= 25 °C (77 °F)
Maximum measured error	< 0.1% of scaled display range
Influence of ambient temperature (temperature drift)	Effect on the accuracy when ambient temperature changes by 1 K (1.8 °F): 0.01%

Installation

Installation instructions	Mounting location Wall or pipe mounting (see 'Accessories')
	Orientation No restrictions, the orientation is determined by the readability of the display.

Environment

Ambient temperature limits	-40 to +80 °C (-40 to +176 °F) -20 to +80 °C (-4 to +176 °F) when the Open Collector output is used
	 The display can react slowly for temperatures < -20 °C (< -4 °F). Readability of the display cannot be guaranteed at temperatures < -30 °C (-22 °F).
Storage temperature	-40 to +80 °C (-40 to +176 °F)
Electrical safety	As per IEC 61010-1, UL61010-1, CSA C22.2 No. 1010.1-92
Climate class	As per IEC 60 654-1, Class C
Degree of protection	IP 67, NEMA 4X (not evaluated by UL)
Shock and vibration resistance	3g / 2 to 150 Hz as per IEC 60 068-2-6
Condensation	Permitted
Installation category	1 to IEC 61010
Pollution degree	2 to IEC 61010
Electromagnetic compatibility (EMC)	<ul style="list-style-type: none"> ■ EN 61326 (IEC 61326): Electromagnetic compatibility (EMC requirements) ■ NAMUR (NE21): Association for Standards for Control and Regulation in the Chemical Industry ■ Maximum deviation: < 0.2 % of span

Mechanical construction

Design, dimensions

Fiber-glass reinforced plastic housing for general purpose or, as an option, aluminum housing

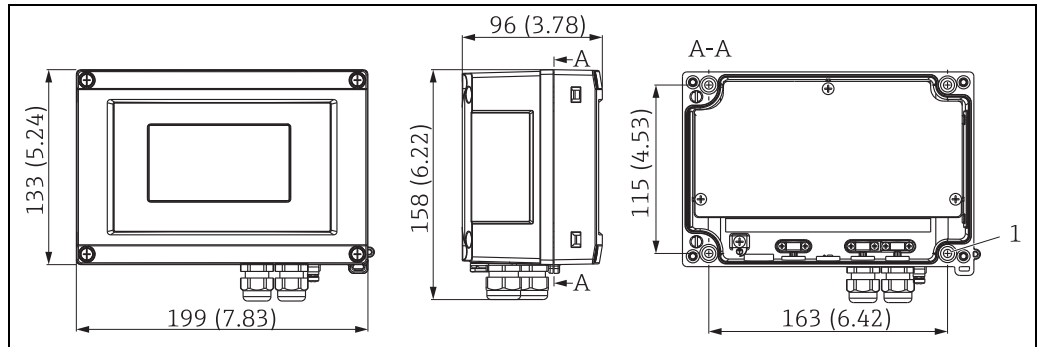

Dimensions in mm (in)

Weight

- Approx. 500 g (1.1 lb) (plastic housing)
- Approx. 1.7 kg (3.75 lb) (aluminum housing)

Material

Housing	Nameplate
Fiber-glass reinforced plastic PBT-GF30	Laser marking
Aluminum AlSi12 (as an option)	Laser-writable foil, polyester

Terminals

Cables / wires up to max. 2.5 mm² (14 AWG) plus ferrule

Human interface

Display elements

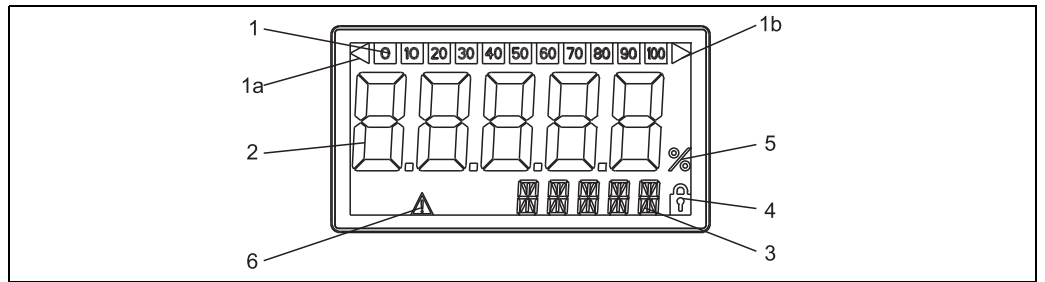

LC display of the field indicator

Item 1: bargraph display in increments of 10% with indicators for measuring range undershoot (item 1a)/overshoot (item 1b)

Item 2: measured value display, character height 26 mm (1.02")

Item 3: 14-segment display for units and information messages

Item 4: symbol "programming disabled"

Item 5: unit "%"

Item 6: warning symbol "failure"

- Display range
-19999 to +99999
- Offset
-19999 to +99999
- Signalling
Measuring range overshoot/undershoot
- Limit value violation
Lower/upper limit value exceeded

Operating elements 3-key operation (-/+/E) integrated in device, access with housing open

Remote operation

Configuration

The device is configured with the FieldCare PC operating software. FieldCare Device Setup forms part of the scope of supply of Commubox FXA291 or TXU10-AC (see 'Accessories') or can be downloaded free of charge from the Internet at www.endress.com.

Interface

Configuration interface at device; connection to PC via configuration cable (see "Accessories").

Configurable device parameters (selection)

Measuring dimension, measuring ranges (linear/square), setup block using user code, failsafe mode, digital filter (damping), offset, limit value (min/max/alarm), alarm limit values freely adjustable.

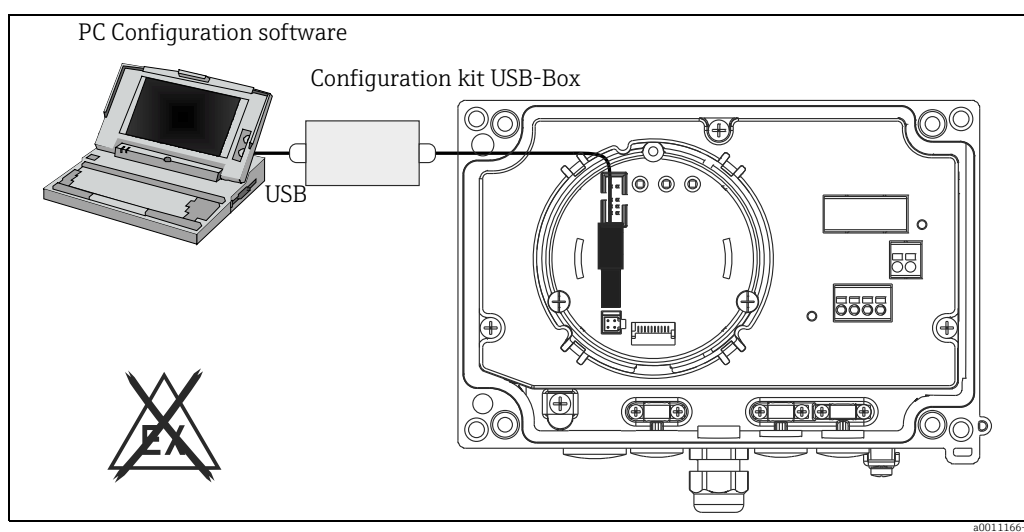

Configuration with PC operating software.

Certificates and approvals

CE mark The device complies with the legal requirements of the EC directives. Endress+Hauser confirms that the device has been successfully tested by affixing to it the CE mark.

Hazardous area approvals Information about currently available Ex versions (ATEX, FM, CSA, etc.) can be supplied by your E+H Sales Center on request. All explosion protection data are given in a separate documentation which is available upon request.

Other standards and guidelines

- IEC 60529: Degree of protection by housing (IP-Code)
- IEC 61010-1: Safety requirements for electrical measurement, control and laboratory instrumentation.
- EN 61326: Electrical equipment for measurement, control and laboratory use - EMC requirements.
- NAMUR: User association of automation technology in process industries (www.namur.de)
- NEMA: Standardization association for the electrical industry in North America.

Marine approval Germanischer Lloyd (GL)

UL Recognized component to UL 3111-1

CSA GP CSA General Purpose

Ordering information

Detailed ordering information is available from the following sources:

- In the Product Configurator on the Endress+Hauser website: www.endress.com → Select country → Instruments → Select device → Product page function: Configure this product
- From your Endress+Hauser Sales Center: www.endress.com/worldwide



Product Configurator - the tool for individual product configuration

- Up-to-the-minute configuration data
- Depending on the device: Direct input of measuring point-specific information such as measuring range or operating language
- Automatic verification of exclusion criteria
- Automatic creation of the order code and its breakdown in PDF or Excel output format
- Ability to order directly in the Endress+Hauser Online Shop

Accessories

Various accessories, which can be ordered with the device or subsequently from Endress+Hauser, are available for the device. Detailed information on the order code in question is available from your local Endress+Hauser sales center or on the product page of the Endress+Hauser website: www.endress.com

Device-specific accessories

Designation	Description
Mounting set wall/pipe (for pipes Ø1-5")	
Weather protection cover	

Communication-specific accessories

Designation
Interface cable
Commubox TXU10 incl. FieldCare Device Setup and DTM Library
Commubox FXA291 incl. FieldCare Device Setup and DTM Library

Documentation

- Overview brochure: System components: FA00016K/09
- Operating Instructions for 'RIA16 field indicator': BA00280R/09
- Supplementary Ex documentation:
ATEX II2(1)G EX ib[ia] IIC T6/T5/T4: XA088R/09/a3

www.addresses.endress.com
