



Level



Pressure



Flow



Temperature



Liquid
Analysis



Registration



Systems
Components



Services



Solutions

Technical Information

Flanges

DIN - EN - ASME - JIS

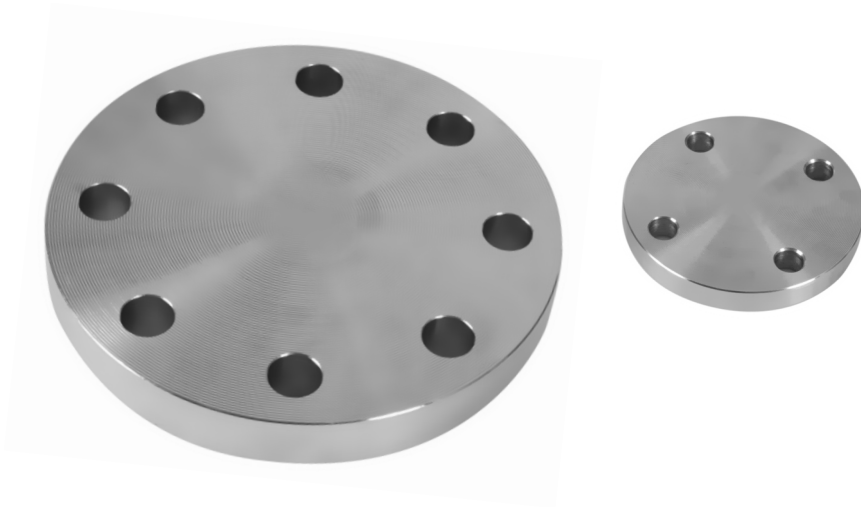

Table of contents

Overview	3
Specifications	3
Versions	3
Flange Norm DIN EN 1092-1	3
Height of raised face	4
Mechanical Construction	5
DIN flanges (DIN 2527)	5
PN10	5
PN16	6
PN25	6
PN40	7
PN64	7
PN100	8
EN flanges (DIN EN 1092-1)	9
PN16	9
PN25	9
PN40	10
PN63	10
PN100	11
ASME flanges (ANSI-B 16.5)	12
150 lbs	12
300 lbs	13
600 lbs	13
900 lbs	14
1500 lbs	14
JIS flanges (B 2220)	15
10 K	15
20 K	15
63 K	16
Adapter flange FAU70	17
FAU70E Version with metrical thread	17
FAU70A Version with conical thread	17
Slip-on flange FAU80	18
FAU80 Version slip-on flange	18
Screw in flange FAX50	19
FAX50 universal flange	
DIN - ASME - JIS	19
G $\frac{3}{4}$, NPT $\frac{3}{4}$	19
G1, NPT1	19
G1- $\frac{1}{2}$, NPT1- $\frac{1}{2}$	20
G2, NPT2	20
Pressure-temperature dependencies	22
EN flanges	22
ASME flanges	22
JIS flanges	22

Overview

Specifications

The material of the flanges delivered is AISI 316L with the material number 1.4404 or 1.4435. With regard to their stability-temperature property, the materials 1.4404 and 1.4435 are grouped in DIN EN 1092-1 table 18 under 13E0 and in JIS B2220:2004 table 5 under 023b. The ASME flanges are dual rated flanges (316/316L) and grouped in table 2-2.2 according to ANSI B16.5:2009.

Note!

Values in inches are converted to values in millimeters using the factor 2.54.



The mm values are rounded off to the nearest 0 or 5 in the ASME standard.

Versions

DIN flanges	EN flanges	ASME flanges	JIS flanges
German National Standards Institute	European Standards	America Society of Mechanical Engineers	Japanese Industrial Standard
DIN 2527	DIN EN 1092-1:2002-06 and 2007	ANSI B 16.5:2009	B2220:2004

Flange Norm DIN EN 1092-1

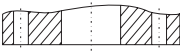
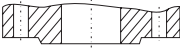
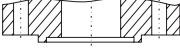
Endress+Hauser usually delivers only flanges with flat face. This type of flange has hardly changed. Thus, a comparison is done only for this sealing surfaces. Due to the change of the designation of the sealing surface mistakes may occur occasionally. The roughness (Rz) of the old raised face form C and the new one B1 have an overlapping between 40 to 50 μm . In this roughness window both standards are fulfilled. Therefore, at Endress+Hauser the flanges are specified according to both flange standards. This double marking makes it clear that both standards are met.

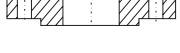
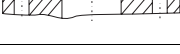
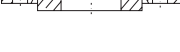
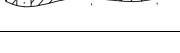
Flange	Sealing Surface	DIN 2526 ¹⁾		DIN EN 1092-1		
		Form	Rz (μm)	Form	Rz (μm)	Ra (μm)
without raised face		A B	- 40 - 160	A ²⁾	12.5 - 50	3.2 - 12.5
with raised face		C D E	40 - 160 40 16	B1 ³⁾ B2	12.5 - 50 3.2 - 12.5	3.2 - 12.5 0.8 - 3.2
tongue		F	-	C		
groove		N	-	D	3.2 - 12.5	0.8 - 3.2
projection		V 13	-	E		
recess		R 13	-	F	12.5 - 50	3.2 - 12.5
projection		V 14		H		
recess		R 14	for O-rings	G	3.2 - 12.5	3.2 - 12.5

1) contained in DIN 2527

2) typically of PN2.5 bis PN40

3) typically of PN63

- Flange to the old DIN standard are compatible to the new DIN EN 1092-1.
- Change in pressure rating: old DIN standards PN64 → DIN EN 1092-1 PN63.

Height of raised face

Dimensions in mm (in).

Standard	Flange	Height of raised face f	Tolerance
DIN EN 1092-1:2002-06	all types	2 (0.08)	0 -1 (-0.04)
DIN EN 1092-1:2007	≤ DN 32	2 (0.08)	0 -1 (-0.04)
	> DN 32 up to DN 250	3 (0.12)	0 -2 (-0.08)
	> DN 250 up to DN 500	4 (0.16)	0 -3 (-0.12)
	> DN 500	5 (0.19)	0 -4 (-0.16)
ASME ANSI B 16.5:2009	≤ 300 lbs	1.6 (0.06)	±0.75 (±0.03)
	≥ 600 lbs	6.4 (0.25)	±0.5 (±0.02)
JIS B2220:2004	< DN 20	1.5 (0.06) 0	-
	> DN 20 up to DN 50	2 (0.08) 0	
	> DN 50	3 (0.12) 0	

Mechanical Construction

DIN flanges (DIN 2527)

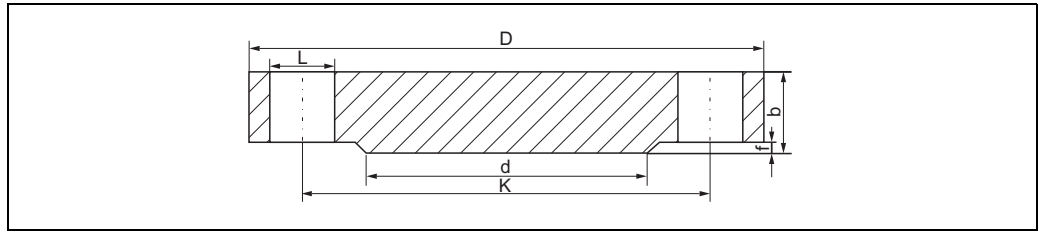

L00-Flangexxx-06-xx-07-xx-002

(raised face DIN 2526 form C)

- L Diameter of holes
- d Raised face diameter
- K Diameter of hole circle
- D Flange diameter
- b Total flange thickness
- f Raised face height (general 2 mm (0.08 in))

PN10

In following tables, the dimensions are indicated in mm (in) unless otherwise noted.

DN	D	b	K	d	L	approx. kg (lbs)
25	115 (4.53)	16 (0.63)	85 (3.35)	68 (2.68)	4xØ14 (0.55)	1.23 (2.71)
32	140 (5.51)	16 (0.63)	100 (3.94)	78 (3.07)	4xØ18 (0.71)	1.80 (3.97)
40	150 (5.91)	16 (0.63)	110 (4.33)	88 (3.46)	4xØ18 (0.71)	2.09 (4.61)
50	165 (6.50)	18 (0.71)	125 (4.92)	102 (4.02)	4xØ18 (0.71)	2.88 (6.35)
65	185 (7.28)	18 (0.71)	145 (5.71)	122 (4.80)	4xØ18 (0.71)	3.70 (8.16)
80	200 (7.87)	20 (0.79)	160 (6.30)	138 (5.43)	8xØ18 (0.71)	4.83 (10.65)
100	220 (8.66)	20 (0.79)	180 (7.09)	158 (6.22)	8xØ18 (0.71)	5.75 (12.68)
125	250 (9.84)	22 (0.87)	210 (8.27)	188 (7.40)	8xØ18 (0.71)	8.59 (18.94)
150	285 (11.2)	22 (0.87)	240 (9.45)	212 (8.35)	8xØ22 (0.87)	10.6 (23.37)
175	315 (12.4)	24 (0.94)	270 (10.6)	242 (9.53)	8xØ22 (0.87)	14.3 (31.53)
200	340 (13.4)	24 (0.94)	295 (11.6)	268 (10.6)	8xØ22 (0.87)	16.9 (37.26)
250	395 (15.6)	26 (1.02)	350 (13.8)	320 (12.6)	12xØ22 (0.87)	24.7 (54.46)
300	445 (17.5)	26 (1.02)	400 (15.7)	370 (14.6)	12xØ22 (0.87)	31.9 (70.34)

PN16

DN	D	b	K	d	L	approx. kg (lbs)
25	115 (4.53)	16 (0.63)	85 (3.35)	68 (2.68)	4xØ14 (0.55)	1.23 (2.71)
32	140 (5.51)	16 (0.63)	100 (3.94)	78 (3.07)	4xØ18 (0.71)	1.80 (3.97)
40	150 (5.91)	16 (0.63)	110 (4.33)	88 (3.46)	4xØ18 (0.71)	2.09 (4.61)
50	165 (6.50)	18 (0.71)	125 (4.92)	102 (4.02)	4xØ18 (0.71)	2.88 (6.35)
65	185 (7.28)	18 (0.71)	145 (5.71)	122 (4.80)	4xØ18 (0.71)	3.70 (8.16)
80	200 (7.87)	20 (0.79)	160 (6.30)	138 (5.43)	8xØ18 (0.71)	4.83 (10.65)
100	220 (8.66)	20 (0.79)	180 (7.09)	158 (6.22)	8xØ18 (0.71)	5.75 (12.68)
125	250 (9.84)	22 (0.87)	210 (8.27)	188 (7.40)	8xØ18 (0.71)	8.59 (18.94)
150	285 (11.2)	22 (0.87)	240 (9.45)	212 (8.35)	8xØ22 (0.87)	10.6 (23.37)
175	315 (12.4)	24 (0.94)	270 (10.6)	242 (9.53)	8xØ22 (0.87)	14.3 (31.53)
200	340 (13.4)	24 (0.94)	295 (11.6)	268 (10.6)	12xØ22 (0.87)	16.5 (36.38)
250	405 (15.9)	26 (1.02)	355 (14.0)	320 (12.6)	12xØ26 (1.02)	25.6 (56.45)
300	460 (18.1)	28 (1.10)	410 (16.1)	378 (14.9)	12xØ26 (1.02)	36.1 (79.60)

PN25

DN	D	b	K	d	L	approx. kg (lbs)
25	115 (4.53)	18 (0.71)	85 (3.35)	68 (2.68)	4xØ14 (0.55)	1.38 (3.04)
32	140 (5.51)	18 (0.71)	100 (3.94)	78 (3.07)	4xØ18 (0.71)	2.03 (4.48)
40	150 (5.91)	18 (0.71)	110 (4.33)	88 (3.46)	4xØ18 (0.71)	2.35 (5.18)
50	165 (6.50)	20 (0.79)	125 (4.92)	102 (4.02)	4xØ18 (0.71)	3.20 (7.06)
65	185 (7.28)	22 (0.87)	145 (5.71)	122 (4.80)	8xØ18 (0.71)	4.33 (9.55)
80	200 (7.87)	24 (0.94)	160 (6.30)	138 (5.43)	8xØ18 (0.71)	5.94 (13.1)
100	235 (9.25)	24 (0.94)	190 (7.48)	162 (6.38)	8xØ22 (0.87)	7.64 (16.85)
125	270 (10.6)	26 (1.02)	220 (8.66)	188 (7.40)	8xØ26 (1.02)	11.0 (24.26)
150	300 (11.8)	28 (1.10)	250 (9.84)	218 (8.58)	8xØ26 (1.02)	14.7 (32.41)
175	330 (13.0)	28 (1.10)	280 (11.0)	248 (9.76)	12xØ26 (1.02)	17.6 (38.81)
200	360 (14.2)	30 (1.18)	310 (12.2)	278 (10.9)	12xØ26 (1.02)	22.7 (50.05)
250	425 (16.7)	32 (1.26)	370 (14.6)	335 (13.2)	12xØ30 (1.18)	34.2 (75.41)
300	485 (19.1)	34 (1.34)	430 (17.0)	395 (15.6)	16xØ30 (1.18)	47.3 (104.3)

PN40

DN	D	b	K	d	L	approx. kg (lbs)
25	115 (4.53)	18 (0.71)	85 (3.35)	68 (2.68)	4xØ14 (0.55)	1.38 (3.04)
32	140 (5.51)	18 (0.71)	100 (3.94)	78 (3.07)	4xØ18 (0.71)	2.03 (4.48)
40	150 (5.91)	18 (0.71)	110 (4.33)	88 (3.46)	4xØ18 (0.71)	2.35 (5.18)
50	165 (6.50)	20 (0.79)	125 (4.92)	102 (4.02)	4xØ18 (0.71)	3.20 (7.06)
65	185 (7.28)	22 (0.87)	145 (5.71)	122 (4.80)	8xØ18 (0.71)	4.33 (9.55)
80	200 (7.87)	24 (0.94)	160 (6.30)	138 (5.43)	8xØ18 (0.71)	5.94 (13.1)
100	235 (9.25)	24 (0.94)	190 (7.48)	162 (6.38)	8xØ22 (0.87)	7.64 (16.85)
125	270 (10.6)	26 (1.02)	220 (8.66)	188 (7.40)	8xØ26 (1.02)	11.0 (24.26)
150	300 (11.8)	28 (1.10)	250 (9.84)	218 (8.58)	8xØ26 (1.02)	14.7 (32.41)
175	350 (13.8)	32 (1.26)	295 (11.6)	260 (10.2)	12xØ30 (1.18)	22.4 (49.39)
200	375 (14.8)	34 (1.34)	320 (12.6)	285 (11.2)	12xØ30 (1.18)	27.6 (60.86)
250	450 (17.7)	38 (1.50)	385 (15.2)	345 (13.6)	12xØ33 (1.30)	44.5 (98.12)
300	515 (20.3)	42 (1.65)	450 (17.7)	410 (16.1)	16xØ33 (1.30)	64.3 (141.8)

PN64

DN	D	b	K	d	L	approx. kg (lbs)
25	140 (5.51)	24 (0.94)	100 (3.94)	68 (2.68)	4xØ18 (0.71)	2.65 (5.84)
32	155 (6.10)	24 (0.94)	110 (4.33)	78 (3.07)	4xØ22 (0.87)	3.24 (7.14)
40	170 (6.69)	26 (1.02)	125 (4.92)	88 (3.46)	4xØ22 (0.87)	4.09 (9.02)
50	180 (7.09)	26 (1.02)	135 (5.31)	102 (4.02)	4xØ22 (0.87)	4.51 (9.94)
65	205 (8.07)	26 (1.02)	160 (6.30)	122 (4.80)	8xØ22 (0.87)	5.71 (12.59)
80	215 (8.46)	28 (1.10)	170 (6.69)	138 (5.43)	8xØ22 (0.87)	6.92 (15.26)
100	250 (9.84)	30 (1.18)	200 (7.87)	162 (6.38)	8xØ26 (1.02)	10.1 (22.27)
125	295 (11.6)	34 (1.34)	240 (9.45)	188 (7.40)	8xØ30 (1.18)	16.0 (35.28)
150	345 (13.6)	36 (1.42)	280 (11.0)	218 (8.58)	8xØ33 (1.30)	23.5 (51.82)
175	375 (14.8)	40 (1.57)	310 (12.2)	260 (10.2)	12xØ33 (1.30)	30.8 (67.91)
200	415 (16.3)	42 (1.65)	345 (13.6)	285 (11.2)	12xØ36 (1.42)	39.7 (87.54)
250	470 (18.5)	46 (1.81)	400 (15.7)	345 (13.6)	12xØ36 (1.42)	57.4 (126.6)
300	530 (20.9)	52 (2.05)	460 (18.1)	410 (16.1)	16xØ36 (1.42)	81.0 (178.6)

PN100

DN	D	b	K	d	L	approx. kg (lbs)
25	140 (5.51)	24 (0.94)	100 (3.94)	68 (2.68)	4xØ18 (0.71)	2.65 (5.84)
32	155 (6.10)	24 (0.94)	110 (4.33)	78 (3.07)	4xØ22 (0.87)	3.24 (7.14)
40	170 (6.69)	26 (1.02)	125 (4.92)	88 (3.46)	4xØ22 (0.87)	4.09 (9.02)
50	195 (7.68)	28 (1.10)	145 (5.71)	102 (4.02)	4xØ26 (1.02)	5.84 (12.88)
65	220 (8.66)	30 (1.18)	170 (6.69)	122 (4.80)	8xØ26 (1.02)	8.03 (17.71)
80	230 (9.06)	32 (1.26)	180 (7.09)	138 (5.43)	8xØ26 (1.02)	9.43 (20.79)
100	265 (10.4)	36 (1.42)	210 (8.27)	162 (6.38)	8xØ30 (1.18)	14.3 (31.53)
125	315 (12.4)	40 (1.57)	250 (9.84)	188 (7.40)	8xØ33 (1.30)	22.6 (49.83)
150	355 (14.0)	44 (1.73)	290 (11.4)	218 (8.58)	12xØ33 (1.30)	31.8 (70.12)
175	385 (15.2)	48 (1.89)	320 (12.6)	260 (10.2)	12xØ33 (1.30)	41.3 (91.07)
200	430 (16.9)	52 (2.05)	360 (14.2)	285 (11.2)	12xØ36 (1.42)	56.1 (123.7)
250	505 (19.9)	60 (2.36)	430 (16.9)	345 (13.6)	12xØ39 (1.54)	89.6 (197.6)
300	585 (23.0)	68 (2.68)	500 (19.7)	410 (16.1)	16xØ42 (1.65)	119 (262.4)

**EN flanges
(DIN EN 1092-1)**

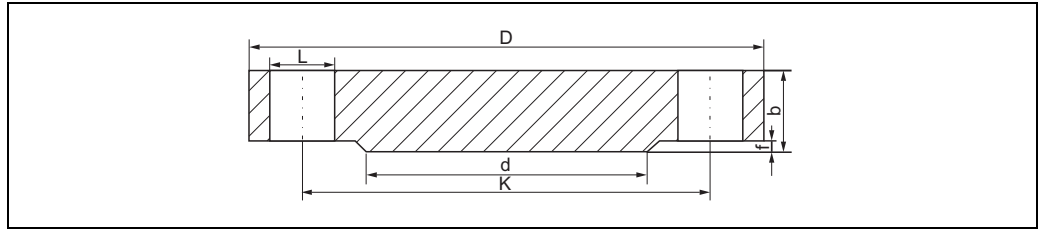

100-Flangexxx-06-xx-07-xx-002

(Raised face B1)

- L Diameter of holes
- d Raised face diameter
- K Diameter of hole circle
- D Flange diameter
- b Total flange thickness
- f Raised face height (general 2 mm (0.08 in))

PN16

In following tables, the dimensions are indicated in mm (in) unless otherwise noted.

DN	D	b	K	d	L	approx. kg (lbs)
25	115 (4.53)	18 (0.71)	85 (3.35)	68 (2.68)	4xØ14 (0.55)	1.50 (3.31)
32	140 (5.51)	18 (0.71)	100 (3.94)	78 (3.07)	4xØ18 (0.71)	2.00 (4.41)
40	150 (5.91)	18 (0.71)	110 (4.33)	88 (3.46)	4xØ18 (0.71)	2.50 (5.51)
50	165 (6.50)	18 (0.71)	125 (4.92)	102 (4.02)	4xØ18 (0.71)	2.90 (6.39)
65	185 (7.28)	18 (0.71)	145 (5.71)	122 (4.80)	8xØ18 (0.71)	3.50 (7.72)
80	200 (7.87)	20 (0.79)	160 (6.30)	138 (5.43)	8xØ18 (0.71)	4.50 (9.92)
100	220 (8.66)	20 (0.79)	180 (7.09)	158 (6.22)	8xØ18 (0.71)	5.50 (12.13)
125	250 (9.84)	22 (0.87)	210 (8.27)	188 (7.40)	8xØ18 (0.71)	8.00 (17.64)
150	285 (11.2)	22 (0.87)	240 (9.45)	212 (8.35)	8xØ22 (0.87)	10.5 (23.15)
200	340 (13.4)	24 (0.94)	295 (11.6)	268 (10.6)	12xØ22 (0.87)	16.5 (36.38)
250	405 (15.9)	26 (1.02)	355 (14.0)	320 (12.6)	12xØ26 (1.02)	25.0 (55.13)
300	460 (18.1)	28 (1.10)	410 (16.1)	378 (14.9)	12xØ26 (1.02)	35.0 (77.18)

PN25

DN	D	b	K	d	L	approx. kg (lbs)
25	115 (4.53)	18 (0.71)	85 (3.35)	68 (2.68)	4xØ14 (0.55)	1.50 (3.31)
32	140 (5.51)	18 (0.71)	100 (3.94)	78 (3.07)	4xØ18 (0.71)	2.00 (4.41)
40	150 (5.91)	18 (0.71)	110 (4.33)	88 (3.46)	4xØ18 (0.71)	2.50 (5.51)
50	165 (6.50)	20 (0.79)	125 (4.92)	102 (4.02)	4xØ18 (0.71)	3.00 (6.62)
65	185 (7.28)	22 (0.87)	145 (5.71)	122 (4.80)	8xØ18 (0.71)	4.50 (9.92)
80	200 (7.87)	24 (0.94)	160 (6.30)	138 (5.43)	8xØ18 (0.71)	5.50 (12.13)
100	235 (9.25)	24 (0.94)	190 (7.48)	162 (6.38)	8xØ22 (0.87)	7.50 (16.54)
125	270 (10.6)	26 (1.02)	220 (8.66)	188 (7.40)	8xØ26 (1.02)	11.0 (24.26)
150	300 (11.8)	28 (1.10)	250 (9.84)	218 (8.58)	8xØ26 (1.02)	14.5 (31.97)
200	360 (14.2)	30 (1.18)	310 (12.2)	278 (10.9)	12xØ26 (1.02)	22.5 (49.61)
250	425 (16.7)	32 (1.26)	370 (14.6)	335 (13.2)	12xØ30 (1.18)	33.5 (73.9)
300	485 (19.1)	34 (1.34)	430 (16.9)	395 (15.6)	16xØ30 (1.18)	46.5 (102.5)

PN40

DN	D	b	K	d	L	approx. kg (lbs)
25	115 (4.53)	18 (0.71)	85 (3.35)	68 (2.68)	4xØ14 (0.55)	1.50 (3.31)
32	140 (5.51)	18 (0.71)	100 (3.94)	78 (3.07)	4xØ18 (0.71)	2.00 (4.41)
40	150 (5.91)	18 (0.71)	110 (4.33)	88 (3.46)	4xØ18 (0.71)	2.50 (5.51)
50	165 (6.50)	20 (0.79)	125 (4.92)	102 (4.02)	4xØ18 (0.71)	3.00 (6.62)
65	185 (7.28)	22 (0.87)	145 (5.71)	122 (4.80)	8xØ18 (0.71)	4.50 (9.92)
80	200 (7.87)	24 (0.94)	160 (6.30)	138 (5.43)	8xØ18 (0.71)	5.50 (12.13)
100	235 (9.25)	24 (0.94)	190 (7.48)	162 (6.38)	8xØ22 (0.87)	7.50 (16.54)
125	270 (10.6)	26 (1.02)	220 (8.66)	188 (7.40)	8xØ26 (1.02)	11.0 (24.26)
150	300 (11.8)	28 (1.10)	250 (9.84)	218 (8.58)	8xØ26 (1.02)	14.5 (31.97)
200	375 (14.8)	36 (1.42)	320 (12.6)	285 (11.2)	12xØ30 (1.18)	29.0 (63.95)
250	450 (17.7)	38 (1.50)	385 (15.2)	345 (13.6)	12xØ33 (1.30)	44.5 (98.12)
300	515 (20.3)	42 (1.65)	450 (17.7)	410 (16.1)	16xØ33 (1.30)	64.0 (141.1)

PN63

DN	D	b	K	d	L	approx. kg (lbs)
25	140 (5.51)	24 (0.94)	100 (3.94)	68 (2.68)	4xØ18 (0.71)	2.50 (5.51)
32	155 (6.10)	24 (0.94)	110 (4.33)	78 (3.07)	4xØ22 (0.87)	3.50 (7.72)
40	170 (6.69)	26 (1.02)	125 (4.92)	88 (3.46)	4xØ22 (0.87)	4.50 (9.92)
50	180 (7.09)	26 (1.02)	135 (5.31)	102 (4.02)	4xØ22 (0.87)	5.00 (11.03)
65	205 (8.07)	26 (1.02)	160 (6.30)	122 (4.80)	8xØ22 (0.87)	6.00 (13.23)
80	215 (8.46)	28 (1.10)	170 (6.69)	138 (5.43)	8xØ22 (0.87)	7.50 (16.54)
100	250 (9.84)	30 (1.18)	200 (7.87)	162 (6.38)	8xØ26 (1.02)	10.5 (23.15)
125	295 (11.6)	34 (1.34)	240 (9.45)	188 (7.40)	8xØ30 (1.18)	16.5 (36.38)
150	345 (13.6)	36 (1.42)	280 (11.0)	218 (8.58)	8xØ33 (1.30)	24.5 (54.02)
200	415 (16.3)	42 (1.65)	345 (13.6)	285 (11.2)	12xØ36 (1.42)	40.5 (89.3)
250	470 (18.5)	46 (1.81)	400 (15.7)	345 (13.6)	12xØ36 (1.42)	58.0 (127.9)
300	530 (20.9)	52 (2.05)	460 (18.1)	410 (16.1)	16xØ36 (1.42)	83.5 (184.1)

PN100

DN	D	b	K	d	L	approx. kg (lbs)
25	140 (5.51)	24 (0.94)	100 (3.94)	68 (2.68)	4xØ18 (0.71)	2.50 (5.51)
32	155 (6.10)	24 (0.94)	110 (4.33)	78 (3.07)	4xØ22 (0.87)	3.50 (7.72)
40	170 (6.69)	26 (1.02)	125 (4.92)	88 (3.46)	4xØ22 (0.87)	4.50 (9.92)
50	195 (7.68)	28 (1.10)	145 (5.71)	102 (4.02)	4xØ26 (1.02)	6.00 (13.23)
65	220 (8.66)	30 (1.18)	170 (6.69)	122 (4.80)	8xØ26 (1.02)	8.00 (17.64)
80	230 (9.06)	32 (1.26)	180 (7.09)	138 (5.43)	8xØ26 (1.02)	9.50 (20.95)
100	265 (10.4)	36 (1.42)	210 (8.27)	162 (6.38)	8xØ30 (1.18)	14.0 (30.87)
125	315 (12.4)	40 (1.57)	250 (9.84)	188 (7.40)	8xØ33 (1.30)	22.5 (49.61)
150	355 (14.0)	44 (1.73)	290 (11.4)	218 (8.58)	12xØ33 (1.30)	30.5 (67.25)
200	430 (16.9)	52 (2.05)	360 (14.2)	285 (11.2)	12xØ36 (1.42)	54.5 (120.2)
250	505 (19.9)	60 (2.36)	430 (16.9)	345 (13.6)	12xØ39 (1.54)	87.5 (192.9)
300	585 (23.0)	68 (2.68)	500 (19.7)	410 (16.1)	16xØ42 (1.65)	131.5 (289.9)

**ASME flanges
(ANSI-B 16.5)**

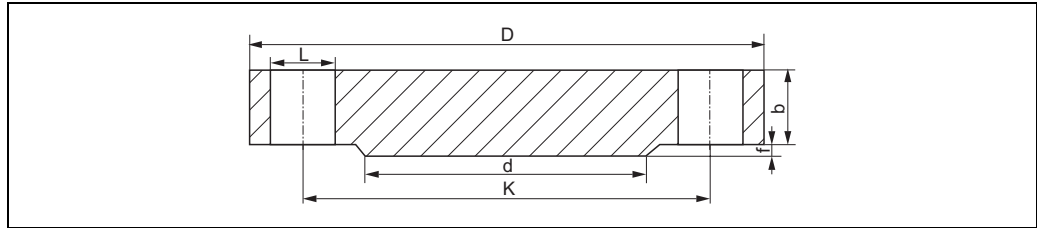

L00-flangexxx-06-xx-07-xx-003

(Raised face RF)

- L Diameter of holes
- d Raised face diameter
- K Diameter of hole circle
- D Flange diameter
- b Total flange thickness
- f Raised face height 150/300 lbs/square inch: 1.6 mm (0.06 in) or from 600 lbs/square inch: 6.4 mm (0.25 in)



Note!
Surface finish of the gasket faces Ra 3.2 to 6.3 μm (126 to 248 μin).

150 lbs

In following tables, the dimensions are indicated in mm (in) unless otherwise noted.

DN	D	b	K	d	L	approx. kg (lbs)
1"	108.0 (4.25)	14.2 (0.56)	79.2 (3.12)	50.8 (2.00)	4xØ15.7 (0.62)	0.86 (1.9)
1¼"	117.3 (4.62)	15.7 (0.62)	88.9 (3.50)	63.5 (2.50)	4xØ15.7 (0.62)	1.17 (2.58)
1½"	127.0 (5.00)	17.5 (0.69)	98.6 (3.88)	73.2 (2.88)	4xØ15.7 (0.62)	1.53 (3.37)
2"	152.4 (6.00)	19.1 (0.75)	120.7 (4.75)	91.9 (3.62)	4xØ19.1 (0.75)	2.42 (5.34)
2½"	177.8 (7.00)	22.4 (0.88)	139.7 (5.50)	104.6 (4.12)	4xØ19.1 (0.75)	3.94 (8.69)
3"	190.5 (7.50)	23.9 (0.94)	152.4 (6.00)	127.0 (5.00)	4xØ19.1 (0.75)	4.93 (10.87)
3½"	215.9 (8.50)	23.9 (0.94)	177.8 (7.00)	139.7 (5.50)	8xØ19.1 (0.75)	6.17 (13.60)
4"	228.6 (9.00)	23.9 (0.94)	190.5 (7.50)	157.2 (6.19)	8xØ19.1 (0.75)	7.00 (15.44)
5"	254.0 (10.0)	23.9 (0.94)	215.9 (8.50)	185.7 (7.31)	8xØ22.4 (0.88)	8.63 (19.03)
6"	279.4 (11.0)	25.4 (1.00)	241.3 (9.50)	215.9 (8.50)	8xØ22.4 (0.88)	11.3 (24.92)
8"	342.9 (13.5)	28.4 (1.12)	298.5 (11.8)	269.7 (10.6)	8xØ22.4 (0.88)	19.6 (43.22)
10"	406.4 (16.0)	30.2 (1.19)	362.0 (14.3)	323.8 (12.7)	12xØ25.4 (1.00)	28.8 (63.50)

300 lbs

DN	D	b	K	d	L	approx. kg (lbs)
1"	124.0 (4.88)	17.5 (0.69)	88.9 (3.50)	50.8 (2.00)	4xØ19.1 (0.75)	1.39 (3.06)
1¼"	133.4 (5.25)	19.1 (0.75)	98.6 (3.88)	63.5 (2.50)	4xØ19.1 (0.75)	1.79 (3.95)
1½"	155.4 (6.12)	20.6 (0.81)	114.3 (4.50)	73.2 (2.88)	4xØ22.4 (0.88)	2.66 (5.87)
2"	165.1 (6.50)	22.4 (0.88)	127.0 (5.00)	91.9 (3.62)	8xØ19.1 (0.75)	3.18 (7.01)
2½"	190.5 (7.50)	25.4 (1.00)	149.4 (5.88)	104.6 (4.12)	8xØ22.4 (0.88)	4.85 (10.69)
3"	209.5 (8.25)	28.4 (1.12)	168.1 (6.62)	127.0 (5.00)	8xØ22.4 (0.88)	6.81 (15.02)
3½"	228.6 (9.00)	30.2 (1.19)	184.2 (7.25)	139.7 (5.50)	8xØ22.4 (0.88)	8.71 (19.21)
4"	254.0 (10.0)	31.8 (1.25)	200.2 (7.88)	157.2 (6.19)	8xØ22.4 (0.88)	11.5 (25.36)
5"	279.4 (11.0)	35.1 (1.38)	235.0 (9.25)	185.7 (7.31)	8xØ22.4 (0.88)	15.6 (34.4)
6"	317.5 (12.5)	36.6 (1.44)	269.7 (10.6)	215.9 (8.50)	12xØ22.4 (0.88)	20.9 (46.08)
8"	381.0 (15.0)	41.1 (1.62)	330.2 (13.0)	269.7 (10.6)	12xØ25.4 (1.00)	34.3 (75.63)
10"	444.5 (17.5)	47.8 (1.88)	387.4 (15.3)	323.8 (12.7)	16xØ28.4 (1.12)	53.3 (117.5)

600 lbs

DN	D	b	K	d	L	approx. kg (lbs)
1"	124.0 (4.88)	17.5 (0.69)	88.9 (3.50)	50.8 (2.00)	4xØ19.1 (0.75)	1.60 (3.53)
1¼"	133.4 (5.25)	20.6 (0.81)	98.6 (3.88)	63.5 (2.50)	4xØ19.1 (0.75)	2.23 (4.92)
1½"	155.4 (6.12)	22.4 (0.88)	114.3 (4.50)	73.2 (2.88)	4xØ22.4 (0.88)	3.25 (7.17)
2"	165.1 (6.50)	25.4 (1.00)	127.0 (5.00)	91.9 (3.62)	8xØ19.1 (0.75)	4.15 (9.15)
2½"	190.5 (7.50)	28.4 (1.12)	149.4 (5.88)	104.6 (4.12)	8xØ22.4 (0.88)	6.13 (13.52)
3"	209.5 (8.25)	31.8 (1.25)	168.1 (6.62)	127.0 (5.00)	8xØ22.4 (0.88)	8.44 (18.61)
3½"	228.6 (9.00)	35.1 (1.38)	184.2 (7.25)	139.7 (5.50)	8xØ25.4 (1.00)	11.0 (24.26)
4"	273.1 (10.8)	38.1 (1.50)	215.9 (8.50)	157.2 (6.19)	8xØ25.4 (1.00)	17.3 (38.15)
5"	330.2 (13.0)	44.5 (1.75)	266.7 (10.5)	185.7 (7.31)	8xØ28.4 (1.12)	29.4 (64.83)
6"	355.6 (14.0)	47.8 (1.88)	292.1 (11.5)	215.9 (8.50)	12xØ28.4 (1.12)	36.1 (79.6)
8"	419.1 (16.5)	55.6 (2.19)	349.3 (13.8)	269.7 (10.6)	12xØ31.8 (1.25)	58.9 (129.9)
10"	508.0 (20.0)	63.5 (2.50)	431.8 (17.0)	323.8 (12.7)	16xØ35.1 (1.38)	97.5 (214.9)

900 lbs

DN	D	b	K	d	L	approx. kg (lbs)
1"	149.4 (5.88)	28.4 (1.12)	101.6 (4.00)	50.8 (2.00)	4xØ25.4 (1.00)	3.57 (7.87)
1¼"	158.8 (6.25)	28.4 (1.12)	111.3 (4.38)	63.5 (2.50)	4xØ25.4 (1.00)	4.14 (9.13)
1½"	177.8 (7.00)	31.8 (1.25)	124.0 (4.88)	73.2 (2.88)	4xØ28.4 (1.12)	5.75 (12.68)
2"	215.9 (8.50)	38.1 (1.50)	165.1 (6.50)	91.9 (3.62)	8xØ25.4 (1.00)	10.1 (22.27)
2½"	244.4 (9.62)	41.1 (1.62)	190.5 (7.50)	104.6 (4.12)	8xØ28.4 (1.12)	14.0 (30.87)
3"	241.3 (9.50)	38.1 (1.50)	190.5 (7.50)	127.0 (5.00)	8xØ25.4 (1.00)	13.1 (28.89)
4"	292.1 (11.50)	44.5 (1.75)	235.0 (9.25)	157.2 (6.19)	8xØ31.8 (1.25)	26.9 (59.31)
5"	349.3 (13.8)	50.8 (2.00)	279.4 (11.0)	185.7 (7.31)	8xØ35.1 (1.38)	36.5 (80.48)
6"	381.0 (15.00)	55.6 (2.19)	317.5 (12.5)	215.9 (8.50)	12xØ31.8 (1.25)	47.4 (104.5)
8"	469.9 (18.50)	63.5 (2.50)	393.7 (15.5)	269.7 (10.6)	12xØ38.1 (1.50)	82.5 (181.9)
10"	546.1 (21.50)	69.9 (2.75)	469.9 (18.5)	323.8 (12.7)	16xØ38.1 (1.50)	122 (269.0)

1500 lbs

DN	D	b	K	d	L	approx. kg (lbs)
1"	149.4 (5.88)	28.4 (1.12)	101.6 (4.00)	50.8 (2.00)	4xØ25.4 (1.00)	3.57 (7.87)
1¼"	158.8 (6.25)	28.4 (1.12)	111.3 (4.38)	63.5 (2.50)	4xØ25.4 (1.00)	4.14 (9.13)
1½"	177.8 (7.00)	31.8 (1.25)	124.0 (4.88)	73.2 (2.88)	4xØ28.4 (1.12)	5.75 (12.68)
2"	215.9 (8.50)	38.1 (1.50)	165.1 (6.50)	91.9 (3.62)	8xØ25.4 (1.00)	10.1 (22.27)
2½"	244.4 (9.62)	41.1 (1.62)	190.5 (7.50)	104.6 (4.12)	8xØ28.4 (1.12)	14.0 (30.87)
3"	266.7 (10.50)	47.8 (1.88)	203.2 (8.00)	127.0 (5.00)	8xØ31.8 (1.25)	19.1 (42.12)
4"	311.2 (12.3)	53.8 (2.12)	241.3 (9.50)	157.2 (6.19)	8xØ35.1 (1.38)	29.9 (65.93)
5"	374.7 (14.8)	73.2 (2.88)	292.1 (11.5)	185.7 (7.31)	8xØ41.1 (1.62)	58.4 (128.8)
6"	393.7 (15.50)	82.6 (3.25)	317.5 (12.5)	215.9 (8.50)	12xØ38.1 (1.50)	71.8 (158.3)
8"	482.6 (19.00)	91.9 (3.62)	393.7 (15.5)	269.7 (10.6)	12xØ44.5 (1.75)	122 (269.0)
10"	584.2 (23.00)	108.0 (4.25)	482.6 (19.0)	323.8 (12.7)	12xØ50.8 (2.00)	210 (463.0)

**JIS flanges
(B 2220)**

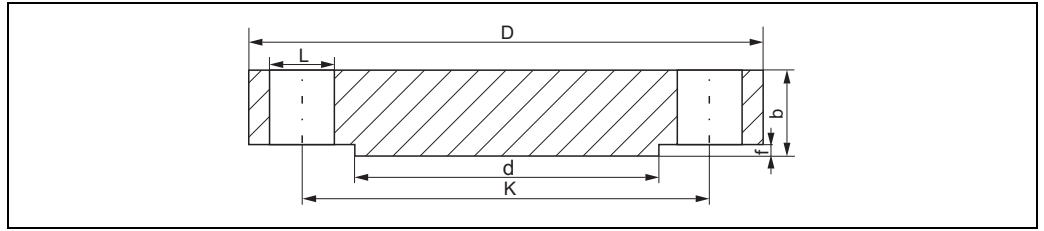

100-Flangexxx-06-xx-07-xx-001

(raised face RF)

- L Diameter of holes
- d Raised face diameter
- K Diameter of hole circle
- D Flange diameter
- b Total flange thickness
- f Raised face height (general 2 mm (0.08 in))



Note!
Surface finish of the gasket faces Ra 3.2 to 6.3 μm (126 to 248 μin).

10 K

In following tables, the dimensions are indicated in mm (in) unless otherwise noted.

DN	D	b	K	d	L
25	125 (4.92)	14 (0.55)	90 (3.54)	67 (2.64)	4xØ19 (0.75)
32	135 (5.31)	16 (0.63)	100 (3.94)	76 (2.99)	4xØ19 (0.75)
40	140 (5.51)	16 (0.63)	105 (4.13)	81 (3.19)	4xØ19 (0.75)
50	155 (6.10)	16 (0.63)	120 (4.72)	96 (3.78)	4xØ19 (0.75)
65	175 (6.89)	18 (0.71)	140 (5.51)	116 (4.57)	4xØ19 (0.75)
80	185 (7.28)	18 (0.71)	150 (5.91)	126 (4.96)	8xØ19 (0.75)
100	210 (8.27)	18 (0.71)	175 (6.89)	151 (5.94)	8xØ19 (0.75)
125	250 (9.84)	20 (0.79)	210 (8.27)	182 (7.17)	8xØ23 (0.91)
150	280 (11.0)	22 (0.87)	240 (9.45)	212 (8.35)	8xØ23 (0.91)
200	330 (13.0)	22 (0.87)	290 (11.4)	262 (10.3)	12xØ23 (0.91)
250	400 (15.7)	24 (0.94)	355 (14.0)	324 (12.8)	12xØ25 (0.98)
300	445 (17.5)	24 (0.94)	400 (15.7)	368 (14.5)	16xØ25 (0.98)

20 K

DN	D	b	K	d	L
25	125 (4.92)	16 (0.63)	90 (3.54)	67 (2.64)	4xØ19 (0.75)
32	135 (5.31)	18 (0.71)	100 (3.94)	76 (2.99)	4xØ19 (0.75)
40	140 (5.51)	18 (0.71)	105 (4.13)	81 (3.19)	4xØ19 (0.75)
50	155 (6.10)	18 (0.71)	120 (4.72)	96 (3.78)	8xØ19 (0.75)
65	175 (6.89)	20 (0.79)	140 (5.51)	116 (4.57)	8xØ19 (0.75)
80	200 (7.87)	22 (0.87)	160 (6.30)	132 (5.20)	8xØ23 (0.91)
100	225 (8.86)	24 (0.94)	185 (7.28)	160 (6.30)	8xØ23 (0.91)
125	270 (10.6)	26 (1.02)	225 (8.86)	195 (7.68)	8xØ25 (0.98)
150	305 (12.0)	28 (1.10)	260 (10.2)	230 (9.06)	12xØ25 (0.98)
200	350 (13.8)	30 (1.18)	305 (12.0)	275 (10.8)	12xØ25 (0.98)
250	430 (16.9)	34 (1.34)	380 (15.0)	345 (13.6)	12xØ27 (1.06)
300	480 (18.9)	36 (1.42)	430 (16.9)	395 (15.6)	16xØ27 (1.06)

63 K

DN	D	b	K	d	L
25	140 (5.51)	27 (1.06)	100 (3.94)	70 (2.76)	4xØ23 (0.91)
32	150 (5.91)	30 (1.18)	110 (4.33)	80 (3.15)	4xØ23 (0.91)
40	175 (6.89)	32 (1.26)	130 (5.12)	90 (3.54)	4xØ25 (0.98)
50	185 (7.28)	34 (1.34)	145 (5.71)	105 (4.13)	8xØ23 (0.91)
65	220 (8.66)	38 (1.50)	175 (6.89)	130 (5.12)	8xØ25 (0.98)
80	230 (9.06)	40 (1.57)	185 (7.28)	140 (5.51)	8xØ25 (0.98)
100	270 (10.6)	44 (1.73)	220 (8.66)	165 (6.50)	8xØ27 (1.06)
125	325 (12.8)	50 (1.97)	265 (10.4)	200 (7.87)	8xØ33 (1.30)
150	365 (14.4)	54 (2.13)	305 (12.0)	240 (9.45)	12xØ33 (1.30)
200	425 (16.7)	60 (2.36)	360 (14.2)	290 (11.4)	12xØ33 (1.30)
250	500 (19.7)	68 (2.68)	430 (16.9)	355 (14.0)	12xØ39 (1.54)
300	560 (22.0)	77 (3.03)	485 (19.1)	410 (16.1)	16xØ39 (1.54)

Adapter flange FAU70

An adapter flange makes it possible to use devices with a threaded connection.

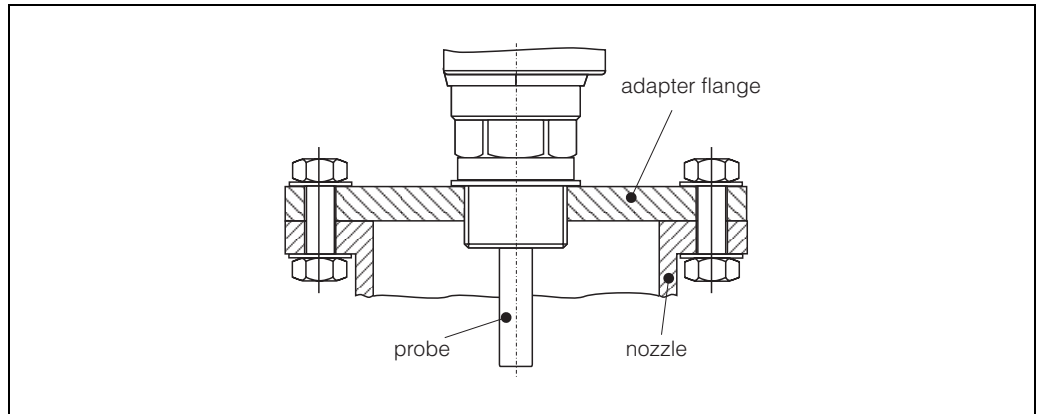

L00-flangexx-00-00-00-en-001

FAU70E Version with metrical thread

Order information

010	Process Connection	
12	DN 50 PN16 A, flange EN 1092-1 (DIN 2527 B)	
14	DN 80 PN16 A, flange EN 1092-1 (DIN 2527 B)	
15	DN 100 PN16 A, flange EN 1092-1 (DIN 2527 B)	
99	Special version, to be specified	
020	Sensor Connection	
3	Thread ISO228 G1-1/2	
4	Thread ISO228 G2	
99	Special version, to be specified	
030	Flange Material	
2	316L	
3	Steel	
7	Polypropylene	
99	Special version, to be specified	

The versions entered make up the order code:

	010	020	030
FAU70E -			

FAU70A Version with conical thread

010	Process Connection	
22	2" 150 lbs FF, flange ANSI B16.5	
24	3" 150 lbs FF, flange ANSI B16.5	
25	4" 150 lbs FF, flange ANSI B16.5	
99	Special version, to be specified	
020	Sensor Connection	
5	Thread NPT1-1/2	
6	Thread NPT2	
99	Special version, to be specified	
030	Flange Material	
2	316L	
3	Steel	
7	Polypropylene	
99	Special version, to be specified	

The versions entered make up the order code:

	010	020	030
FAU70A -			

Slip-on flange FAU80

The sensors (FDU91F, FDU80F, FDU81F) can be flush mounted using a FAU80 slip-on flange. Flanges in polypropylene (PP) should only be used with pressures up to 1.5 bar_{abs} (22 psi) flanges in 316L also above.

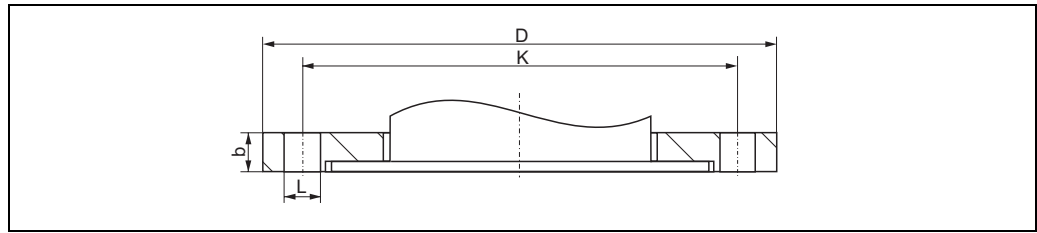

L00-flange:xxx-xx-00-00-xx-000

Details to dimension "Mechanical Construction" → 5

FAU80 Version slip-on flange

Order information

010	Process Connection	
AA	3"	150 lbs FF, flange ANSI B16.5
AH	4"	150 lbs FF, flange ANSI B16.5
CA	DN 80	PN16 A, flange EN1092-1 (DIN2527 B)
CH	DN 100	PN16 A, flange EN1092-1 (DIN2527 B)
KA	10K 80A	FF, flange JIS B2220
KH	10K 100A	FF, flange JIS B2220
YY	Special version, to be specified	
020	Flange Material	
J	316L	
P	PPs, max. 1.5 bar abs	
Y	Special version, to be specified	

The versions entered make up the order code:

	010	020
FAU80 -		

Screw in flange FAX50

The screw in flange is an universal flange. On the basis of dimensions min./max. it can be used for all three standards (DIN - ASME - JIS).

FAX50 universal flange DIN - ASME - JIS

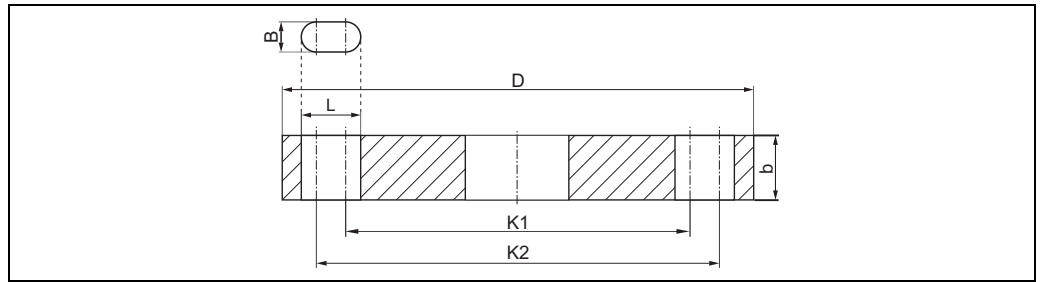

- L Diameter of holes
- K1 Diameter of hole circle
- K2 Diameter of hole circle
- D Flange diameter
- b Total flange thickness
- B Slotted hole (width)

G $\frac{3}{4}$, NPT $\frac{3}{4}$

In following tables, the dimensions are indicated in mm (in) unless otherwise noted.

DN	D	b	L	K1	K2	approx. kg (lbs)		
						PP	PVDF	316L
50	165 (6.50)	20 (0.79)	4x \varnothing 19 (0.75)	120 (4.72)	125 (4.92)	-	-	3.11 (6.86)
80	200 (7.87)		8x \varnothing 19 (0.75)	150 (5.91)	160 (6.30)	-	-	4.37 (9.64)
100	228.6 (9.0)		8x \varnothing 19 (0.75)	175 (6.89)	190.5 (7.5)	-	-	5.79 (12.77)

G1, NPT1

DN	D	b	L	K1	K2	approx. kg (lbs)		
						PP	PVDF	316L
80	200 (7.87)	20 (0.79)	8x \varnothing 19 (0.75)	150 (5.91)	160 (6.30)	0.50 (1.10)	0.97 (2.14)	4.34 (9.57)
100	228.6 (9.0)		8x \varnothing 19 (0.75)	175 (6.89)	190.5 (7.5)	0.66 (1.46)	1.29 (2.84)	5.75 (12.68)
150	285 (11.2)		8x \varnothing 23 (0.91)	240 (9.45)	241.3 (9.5)	1.09 (2.40)	2.12 (4.67)	9.44 (20.82)
200 ¹⁾	340 (13.4)		12x \varnothing 23 (0.91)	290 (11.4)	295 (11.6)	1.53 (3.37)	-	-
250	406.4 (16.0)		12x \varnothing 26 (1.02)	355 (14.0)	362 (14.3)	2.20 (4.85)	-	-

1) Only for DIN und JIS!

Exception G1

DN	D	b	L	K1	K2	approx. kg (lbs)		
						ASME	PP	PVDF
8"	342.9 (13.5)	20 (0.79)	8x \varnothing 22.5 (0.89)	298.5 (11.8)	298.5 (11.8)	1.61 (3.55)	-	-

G1-½, NPT1-½

DN	D	b	L	K1	K2	approx. kg (lbs)		
						PP	PVDF	316L
50	165 (6.50)	20 (0.79)	4xØ19 (0.75)	120 (4.72)	125 (4.92)	0.34 (0.75)	0.67 (1.48)	2.97 (6.55)
80	200 (7.87)		8xØ19 (0.75)	150 (5.91)	160 (6.30)	0.49 (1.08)	0.95 (2.09)	4.24 (9.35)
100	228.6 (9.0)		8xØ19 (0.75)	175 (6.89)	190.5 (7.5)	0.65 (1.43)	1.27 (2.80)	5.65 (12.46)
150	285 (11.2)		8xØ23 (0.91)	240 (9.45)	241.3 (9.5)	1.08 (2.38)	2.09 (4.61)	9.34 (20.59)

G2, NPT2

DN	D	b	L	K1	K2	approx. kg (lbs)		
						PP	PVDF	316L
50	165 (6.50)	20 (0.79)	4xØ19 (0.75)	120 (4.72)	125 (4.92)	0.33 (0.73)	0.63 (1.39)	2.83 (6.24)
80	200 (7.87)		8xØ19 (0.75)	150 (5.91)	160 (6.30)	0.47 (1.04)	0.92 (2.03)	4.10 (9.04)
100	228.6 (9.0)		8xØ19 (0.75)	175 (6.89)	190.5 (7.5)	0.64 (1.41)	1.24 (2.73)	5.51 (12.15)
150	285 (11.2)		8xØ23 (0.91)	240 (9.45)	241.3 (9.5)	1.06 (2.34)	2.06 (4.54)	9.20 (20.29)

Order information FAX50

015 Material:	
BR1	DN50 PN10/16 A, steel flange EN1092-1
BS1	DN80 PN10/16 A, steel flange EN1092-1
BT1	DN100 PN10/16 A, steel flange EN1092-1
JF1	2" 150lbs FF, steel flange ANSI B16.5
JG1	3" 150lbs FF, steel flange ANSI B16.5
JH1	4" 150lbs FF, steel flange ANSI B16.5
JK2	8" 150lbs FF, PP max 3 bar abs/44 psia flange ANSI B16.5
XIF	UNI flange 2"/DN50/50, PVDF max 4 bar abs/58 psia, suitable for 2" 150 lbs/DN50 PN16/10K 50
XIG	UNI flange 2"/DN50/50, PP max 4 bar abs/58 psia, suitable for 2" 150 lbs/DN50 PN16/10K 50
XIJ	UNI flange 2"/DN50/50, 316L max 4 bar abs/58 psia, suitable for 2" 150 lbs/DN50 PN16/10K 50
XJF	UNI flange 3"/DN80/80, PVDF max 4 bar abs/58 psia, suitable for 3" 150 lbs/DN80 PN16/10K 80
XJG	UNI flange 3"/DN80/80, PP max 4 bar abs/58 psia, suitable for 3" 150 lbs/DN80 PN16/10K 80
XJJ	UNI flange 3"/DN80/80, 316L max 4 bar abs/58 psia, suitable for 3" 150 lbs/DN80 PN16/10K 80
XKF	UNI flange 4"/DN100/100, PVDF max 4 bar abs/58 psia, suitable for 4" 150 lbs/DN100 PN16/10K 100
XKG	UNI flange 4"/DN100/100, PP max 4 bar abs/58 psia, suitable for 4" 150 lbs/DN100 PN16/10K 100
XKJ	UNI flange 4"/DN100/100, 316L max 4 bar abs/58 psia, suitable for 4" 150 lbs/DN100 PN16/10K 100
XLF	UNI flange 6"/DN150/150, PVDF max 4 bar abs/58 psia, suitable for 6" 150 lbs/DN150 PN16/10K 150
XLG	UNI flange 6"/DN150/150, PP max 4 bar abs/58 psia, suitable for 6" 150 lbs/DN150 PN16/10K 150
XLJ	UNI flange 6"/DN150/150, 316L max 4 bar abs/58 psia, suitable for 6" 150 lbs/DN150 PN16/10K 150
XMG	UNI flange DN200/200, PP max 4 bar abs/58 psia, suitable for DN200 PN16/10K 200
XNG	UNI flange DN250/250, PP max 4 bar abs/58 psia, suitable for DN250 PN16/10K 250
YYY	Special version

020 Sensor Connection:	
A	Thread ISO228 G3/4
B	Thread ISO228 G1
C	Thread ISO228 G1-1/2
D	Thread ISO228 G2
E	Thread ANSI NPT3/4
F	Thread ANSI NPT1
G	Thread ANSI NPT1-1/2
H	Thread ANSI NPT2
Y	Special version

The versions entered make up the order code:

	15	20
FAX50 -		

Pressure-temperature dependencies

EN flanges¹⁾

Temperature range	Nominal pressure (data in bar (psi))				
	PN16	PN25	PN40	PN63	PN100
-10 °C ... +50 °C (+14 °F ... +122 °F)	16.0 (232)	25.0 (362)	40.0 (580)	63.0 (913)	100.0 (1450)
50 °C (122 °F)	15.5 (225)	24.3 (352)	38.9 (564)	61.3 (889)	97.3 (1411)
100 °C (212 °F)	15.1 (219)	23.6 (342)	37.9 (550)	59.7 (866)	94.7 (1373)
150 °C (302 °F)	13.7 (199)	21.5 (312)	34.4 (499)	54.3 (787)	86.1 (1248)
200 °C (392 °F)	12.7 (184)	19.8 (287)	31.8 (461)	50.1 (726)	79.5 (1153)
250 °C (482 °F)	11.9 (173)	18.6 (270)	29.9 (434)	47.1 (683)	74.7 (1083)
300 °C (572 °F)	11.0 (159)	17.2 (249)	27.6 (400)	43.5 (631)	69.0 (1000)
350 °C (662 °F)	10.5 (152)	16.5 (239)	26.4 (383)	41.7 (605)	66.1 (958)
400 °C (752 °F)	10.2 (148)	16.0 (232)	25.7 (373)	40.1 (580)	64.2 (931)

ASME flanges¹⁾

Temperature range	Nominal pressure (data in bar (psi))				
	150 lbs	300 lbs	600 lbs	900 lbs	1500 lbs
-29 °C ... +38 °C (-20 °F ... +100 °F)	19.0 (275)	49.6 (719)	99.3 (1440)	148.9 (2159)	248.2 (3599)
50 °C (122 °F)	18.4 (267)	48.1 (697)	96.2 (1395)	144.3 (2092)	240.6 (3489)
100 °C (212 °F)	16.2 (235)	42.2 (612)	84.4 (1224)	126.6 (1836)	211.0 (3059)
150 °C (302 °F)	14.8 (215)	38.5 (558)	77.0 (1116)	115.5 (1675)	192.5 (2791)
200 °C (392 °F)	13.7 (199)	35.7 (518)	71.3 (1034)	107.0 (1551)	178.3 (2588)
250 °C (482 °F)	12.1 (175)	33.4 (484)	66.8 (969)	100.1 (1451)	166.9 (2420)
300 °C (572 °F)	10.2 (148)	31.6 (458)	63.2 (916)	94.9 (1376)	158.1 (2292)
325 °C (617 °F)	9.3 (135)	30.9 (448)	61.8 (896)	92.7 (1344)	154.4 (2239)
350 °C (662 °F)	8.4 (122)	30.3 (439)	60.7 (880)	91.0 (1319)	151.6 (2189)
375 °C (707 °F)	7.4 (107)	29.9 (434)	59.8 (867)	89.6 (1299)	149.4 (2166)
400 °C (752 °F)	6.5 (94)	29.4 (426)	58.9 (854)	88.3 (1280)	147.2 (2134)

JIS flanges¹⁾

Temperature range	Nominal pressure (data in bar (psi))			
	10 K	20 K		
	for all flanges	to DN 125	from DN 150 up to DN 250	DN 300
up to 120 °C (248 °F)	14 (203.0)	34 (493.0)	20 (290.0)	20 (290.0)
220 °C (428 °F)	12 (174.0)	31 (449.5)	20 (290.0)	-
300 °C (572 °F)	10 (145.0)	29 (420.5)	19 (275.5)	-
350 °C (662 °F)	-	26 (377.0)	17 (246.5)	-
400 °C (752 °F)	-	23 (333.5)	17 (246.5)	-
425 °C (797 °F)	-	20 (290.0)	17 (246.5)	-

1) With regard to their stability-temperature property, the materials 1.4435 and 1.4404 are grouped in DIN EN 1092-1 table 18 under 13E0 and in JIS B2220:2004 table 5 under 023b. The ASME flanges are dual rated flanges (316/316L) and grouped in table 2-2.2 according to ANSI B16.5:2009.

Instruments International

Endress+Hauser
Instruments International AG
Kaegenstrasse 2
4153 Reinach
Switzerland

Tel. +41 61 715 81 00
Fax +41 61 715 25 00
www.endress.com
info@ii.endress.com

Endress+Hauser 
People for Process Automation

