

the sensor people

## AMS 335*i* Optical Laser Measurement System CANopen

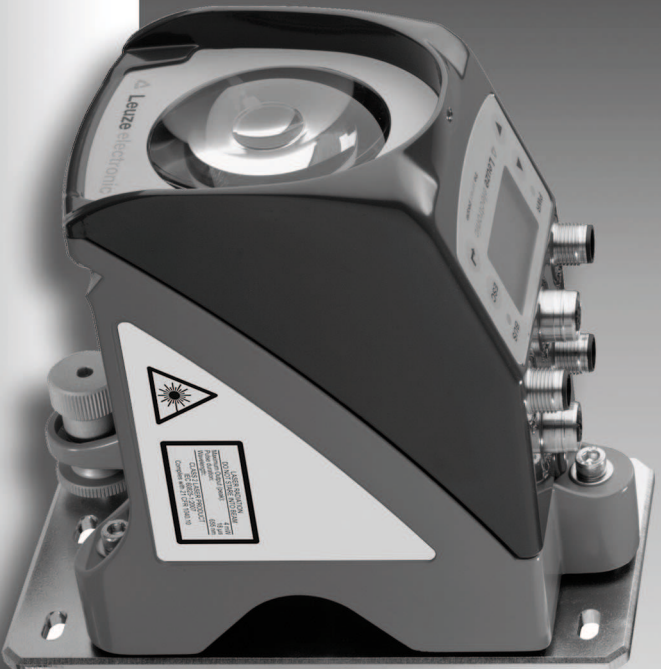

en 03-2014/12 50113356  
We reserve the right to  
make technical changes

© 2014

Leuze electronic GmbH + Co. KG

In der Braike 1

D-73277 Owen - Teck / Germany

Phone: +49 7021 573-0

Fax: +49 7021 573-199

<http://www.leuze.com>

[info@leuze.de](mailto:info@leuze.de)

**The main menus**

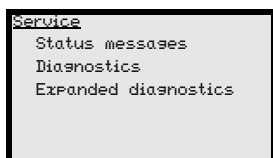
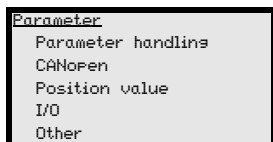
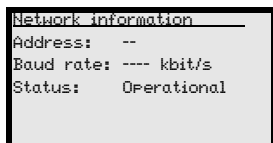
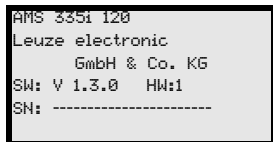

**Device information - main menu**

This menu item contains detailed information on

- Device model,
- Manufacturer,
- Software and hardware version,
- Serial number.

No entries can be made via the display.

**Network information - main menu**

Explanations of address, baud rate, status.

No entries can be made via the display.

**Status- and measurement data - main menu**

- Display of status-, warning-, and error messages.
- Status overview of the switching inputs/outputs.
- Bar graph for the reception level.
- Activated interface.
- Measurement value.

No entries can be made via the display.  
See "Indicators in the display" on page 38.

**Parameter - main menu**

- Configuration of the AMS.

See "Parameter menu" on page 43.

**Language selection - main menu**

- Selection of the display language.



See "Language selection menu" on page 47.

**Service - main menu**

- Display of status messages.
- Display of diagnostic data.

No entries can be made via the display.  
See "Service menu" on page 47.

**Device buttons:**

-  Navigate upward/laterally
-  Navigate downward/laterally
-  ESCAPE leave
-  ENTER confirm

**Input of values**

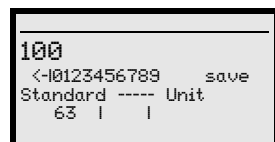

-  Delete character
-  Enter digit
-  Save input

<b>1</b>	<b>General information</b> .....	<b>5</b>
1.1	Explanation of symbols .....	5
1.2	Declaration of conformity .....	5
1.3	Description of functions AMS 335i .....	6
<b>2</b>	<b>Safety</b> .....	<b>7</b>
2.1	Intended use .....	7
2.2	Foreseeable misuse .....	8
2.3	Competent persons .....	8
2.4	Disclaimer .....	9
2.5	Laser safety notices .....	9
<b>3</b>	<b>Fast commissioning / operating principle</b> .....	<b>12</b>
3.1	Mounting the AMS 335i .....	12
3.1.1	Mounting the device .....	12
3.1.2	Mounting the reflector .....	12
3.2	Connecting the voltage supply .....	13
3.3	Display .....	13
3.4	AMS 335i on the CANopen .....	13
<b>4</b>	<b>Specifications</b> .....	<b>14</b>
4.1	Specifications of the laser measurement system .....	14
4.1.1	General specifications AMS 335i .....	14
4.1.2	Dimensioned drawing AMS 335i .....	16
4.1.3	Type overview AMS 335i .....	17
<b>5</b>	<b>Installation and mounting</b> .....	<b>18</b>
5.1	Storage, transportation .....	18
5.2	Mounting the AMS 335i .....	19
5.2.1	Optional mounting bracket .....	21
5.2.2	Parallel mounting of the AMS 335i .....	22
5.2.3	Parallel mounting of AMS 335i and DDLS optical data transmission .....	23
5.3	Mounting the AMS 335i with laser beam deflector unit .....	24
5.3.1	Mounting the laser beam deflector unit With integrated mounting bracket .....	24
5.3.2	Dimensioned drawing of US AMS 01 deflector unit .....	25
5.3.3	Mounting the US 1 OMS deflector unit without mounting bracket .....	26

<b>6</b>	<b>Reflectors</b>	<b>27</b>
6.1	General information	27
6.2	Description of the reflective tape	27
6.2.1	Specifications of the self-adhesive foil	28
6.2.2	Specifications of the reflective tape on a metal plate	28
6.2.3	Dimensioned drawing of reflective tape on a metal plate	29
6.2.4	Specifications of heated reflectors	30
6.2.5	Dimensioned drawing of heated reflectors	31
6.3	Selecting reflector sizes	32
6.4	Mounting the reflector	33
6.4.1	General information	33
6.4.2	Mounting the reflector	33
6.4.3	Table of reflector pitches	36
<b>7</b>	<b>Electrical connection</b>	<b>37</b>
7.1	Safety notices for the electrical connection	37
7.2	PWR – voltage supply / switching input/output	38
7.3	CANopen BUS IN	38
7.4	CANopen BUS OUT	39
7.5	Service	39
<b>8</b>	<b>Display and control panel AMS 335i</b>	<b>40</b>
8.1	Structure of the control panel	40
8.2	Status display and operation	40
8.2.1	Indicators in the display	40
8.2.2	LED status displays	42
8.2.3	Control buttons	43
8.3	Menu description	44
8.3.1	The main menus	44
8.3.2	Parameter menu	45
8.3.3	Language selection menu	49
8.3.4	Service menu	49
8.4	Operation	50
<b>9</b>	<b>CANopen interface</b>	<b>52</b>
9.1	General information on CANopen	52
9.1.1	Topology	52
9.1.2	Bus line (trunk line)	52

9.1.3	Stub lines (drop lines) . . . . .	53
<b>9.2</b>	<b>Address assignment . . . . .</b>	<b>54</b>
9.2.1	Entering the address via the display . . . . .	54
<b>9.3</b>	<b>Baud rate setting . . . . .</b>	<b>55</b>
9.3.1	Entering the baud rate via the display/panel . . . . .	55
<b>9.4</b>	<b>CANopen electrical connection . . . . .</b>	<b>56</b>
<b>9.5</b>	<b>Communication mechanisms of the AMS 335i on CAN. . . . .</b>	<b>57</b>
9.5.1	Device profile of the AMS 335i . . . . .	57
9.5.2	Object directories . . . . .	57
9.5.3	EDS file . . . . .	58
9.5.4	SDOs and PDOs . . . . .	58
9.5.5	Default 11 Bit - Identifier distribution . . . . .	60
9.5.6	The communication-specific objects according to DS301, DS406 and manufacturer-specific61	
9.5.7	Detailed description of CANopen-specific object area . . . . .	62
9.5.8	AMS 335i-specific object area . . . . .	67
9.5.9	Objects of the AMS 335i from the DS406 class 1 encoder profile. . . . .	86
<b>10</b>	<b>Diagnostics and troubleshooting . . . . .</b>	<b>88</b>
<b>10.1</b>	<b>Service and diagnostics in the display of the AMS 335i . . . . .</b>	<b>88</b>
10.1.1	Status messages . . . . .	88
10.1.2	Diagnostics . . . . .	89
10.1.3	Expanded diagnostics . . . . .	89
<b>10.2</b>	<b>General causes of errors . . . . .</b>	<b>90</b>
10.2.1	Power LED . . . . .	90
<b>10.3</b>	<b>Interface errors. . . . .</b>	<b>90</b>
10.3.1	BUS LED . . . . .	90
<b>10.4</b>	<b>Status display in the display of the AMS 335i . . . . .</b>	<b>90</b>
<b>11</b>	<b>Type overview and accessories . . . . .</b>	<b>92</b>
<b>11.1</b>	<b>Type key . . . . .</b>	<b>92</b>
11.1.1	Type overview AMS 335i (CANopen) . . . . .	92
<b>11.2</b>	<b>Overview of reflector types . . . . .</b>	<b>93</b>
<b>11.3</b>	<b>Accessories . . . . .</b>	<b>93</b>
11.3.1	Accessory mounting bracket . . . . .	93
11.3.2	Accessory deflector unit . . . . .	93
11.3.3	Accessory M12 connector . . . . .	93
11.3.4	Accessory terminating resistor . . . . .	94
11.3.5	Accessory ready-made cables for voltage supply . . . . .	94
11.3.6	Accessory ready-made cables for CANopen . . . . .	95

<b>12</b>	<b>Maintenance</b> .....	<b>97</b>
12.1	General maintenance information .....	97
12.2	Repairs, servicing .....	97
12.3	Disassembling, packing, disposing .....	97

## 1 General information

### 1.1 Explanation of symbols

The symbols used in this operating manual are explained below.



**Attention!**

*This symbol precedes text messages which must strictly be observed. Failure to comply with this information results in injuries to personnel or damage to the equipment.*



**Attention Laser!**

*This symbol warns of possible danger caused by hazardous laser radiation.*



**Notice!**

*This symbol indicates text passages containing important information.*

### 1.2 Declaration of conformity

The AMS 335*i* absolute measuring optical laser measurement system was designed and manufactured in accordance with applicable European directives and standards.

The AMS series is "UL LISTED" according to American and Canadian safety standards and fulfills the requirements of Underwriter Laboratories Inc. (UL).



**Notice!**

*The Declaration of Conformity for these devices can be requested from the manufacturer.*

The manufacturer of the product, Leuze electronic GmbH + Co. KG in D-73277 Owen/Teck, possesses a certified quality assurance system in accordance with ISO 9001.

















### 1.3 Description of functions AMS 335*i*

The AMS 335*i* optical laser measurement system calculates distances to fixed as well as moving system parts. The distance to be measured is calculated according to the principle of the propagation time of radiated light. Here, the light emitted by the laser diode is reflected by a reflector onto the receiving element of the laser measurement system. The AMS 335*i* uses the "propagation time" of the light to calculate the distance to the reflector. The high absolute measurement accuracy of the laser measurement system and the fast integration time are designed for position control applications.

With the AMS 3xx*i* product series, Leuze electronic makes available a range of internationally relevant interfaces. Note that each interface version listed below corresponds to a different AMS 3xx*i* model.

		<b>AMS 304<i>i</i></b>
		<b>AMS 348<i>i</i></b>
		<b>AMS 355<i>i</i></b>
		<b>AMS 358<i>i</i></b>
		<b>AMS 335<i>i</i></b>
		<b>AMS 338<i>i</i></b>
		<b>AMS 308<i>i</i></b>
		<b>AMS 384<i>i</i></b>
		<b>AMS 301<i>i</i></b>
		<b>AMS 300<i>i</i></b>

## 2 Safety

This sensor was developed, manufactured and tested in line with the applicable safety standards. It corresponds to the state of the art.

### 2.1 Intended use

The AMS is an absolute measuring optical laser measurement system which allows distance measurement of up to 300m against a reflector.

#### **Areas of application**

The AMS is designed for the following areas of application:

- Positioning of automated, moving plant components
- Travel and lifting axes of high-bay storage devices
- Repositioning units
- Gantry crane bridges and their trolleys
- Lifts
- Electroplating plants



#### **CAUTION**

##### **Observe intended use!**

↗ Only operate the device in accordance with its intended use. The protection of personnel and the device cannot be guaranteed if the device is operated in a manner not complying with its intended use.

Leuze electronic GmbH + Co. KG is not liable for damages caused by improper use.

↗ Read the technical description before commissioning the device. Knowledge of this technical description is an element of proper use.

##### **NOTICE**

##### **Comply with conditions and regulations!**

↗ Observe the locally applicable legal regulations and the rules of the employer's liability insurance association.



#### **Attention**

*For UL applications, use is permitted exclusively in Class 2 circuits according to NEC (National Electric Code).*

## 2.2 Foreseeable misuse

Any use other than that defined under "Intended use" or which goes beyond that use is considered improper use.

In particular, use of the device is not permitted in the following cases:

- Rooms with explosive atmospheres
- Circuits relevant to safety
- For medicinal purposes

### NOTICE

#### **Do not modify or otherwise interfere with the device.**

- ↳ Do not carry out modifications or otherwise interfere with the device.  
The device must not be tampered with and must not be changed in any way.  
The device must not be opened. There are no user-serviceable parts inside.  
Repairs must only be performed by Leuze electronic GmbH + Co. KG.

## 2.3 Competent persons

Connection, mounting, commissioning and adjustment of the device must only be carried out by competent persons.

Prerequisites for competent persons:

- They have a suitable technical education.
- They are familiar with the rules and regulations for occupational safety and safety at work.
- They are familiar with the technical description of the device.
- They have been instructed by the responsible person on the mounting and operation of the device.

### ***Certified electricians***

Electrical work must be carried out by a certified electrician.

Due to their technical training, knowledge and experience as well as their familiarity with relevant standards and regulations, certified electricians are able to perform work on electrical systems and independently detect possible dangers.

In Germany, certified electricians must fulfill the requirements of accident-prevention regulations BGV A3 (e.g. electrician foreman). In other countries, there are respective regulations that must be observed.

## 2.4 Disclaimer

Leuze electronic GmbH + Co. KG is not liable in the following cases:

- The device is not being used properly.
- Reasonably foreseeable misuse is not taken into account.
- Mounting and electrical connection are not properly performed.
- Changes (e.g., constructional) are made to the device.

## 2.5 Laser safety notices



### ATTENTION LASER RADIATION – LASER CLASS 2

#### Never look directly into the beam!

The device satisfies the requirements of IEC 60825-1:2007 (EN 60825-1:2007) safety regulations for a product in **laser class 2** as well as the U.S. 21 CFR 1040.10 regulations with deviations corresponding to "Laser Notice No. 50" from June 24th, 2007.

- ⚠ Never look directly into the laser beam or in the direction of reflecting laser beams.  
If you look into the beam path over a longer time period, there is a risk of injury to the retina.
- ⚠ Do not point the laser beam of the device at persons!
- ⚠ Interrupt the laser beam using a non-transparent, non-reflective object if the laser beam is accidentally directed towards a person.
- ⚠ When mounting and aligning the device, avoid reflections of the laser beam off reflective surfaces!
- ⚠ CAUTION! The use of operating or adjusting devices other than those specified here or carrying out of differing procedures may lead to dangerous exposure to radiation.
- ⚠ Adhere to the applicable legal and local regulations regarding protection from laser beams.
- ⚠ The device must not be tampered with and must not be changed in any way.  
There are no user-serviceable parts inside the device.  
Repairs must only be performed by Leuze electronic GmbH + Co. KG.

**NOTICE****Affix laser information and warning signs!**

Laser information and warning signs are attached to the device (see figure 2.1):

In addition, self-adhesive laser warning and information signs (stick-on labels) are supplied in several languages (see figure 2.2).

↪ Affix the laser information sheet to the device in the language appropriate for the place of use.

When using the device in the US, use the stick-on label with the "Complies with 21 CFR 1040.10" notice.

↪ Affix the laser information and warning signs near the device if no signs are attached to the device (e.g., because the device is too small) or if the attached laser information and warning signs are concealed due to the installation position.

Affix the laser information and warning signs so that they are legible without exposing the reader to the laser radiation of the device or other optical radiation.

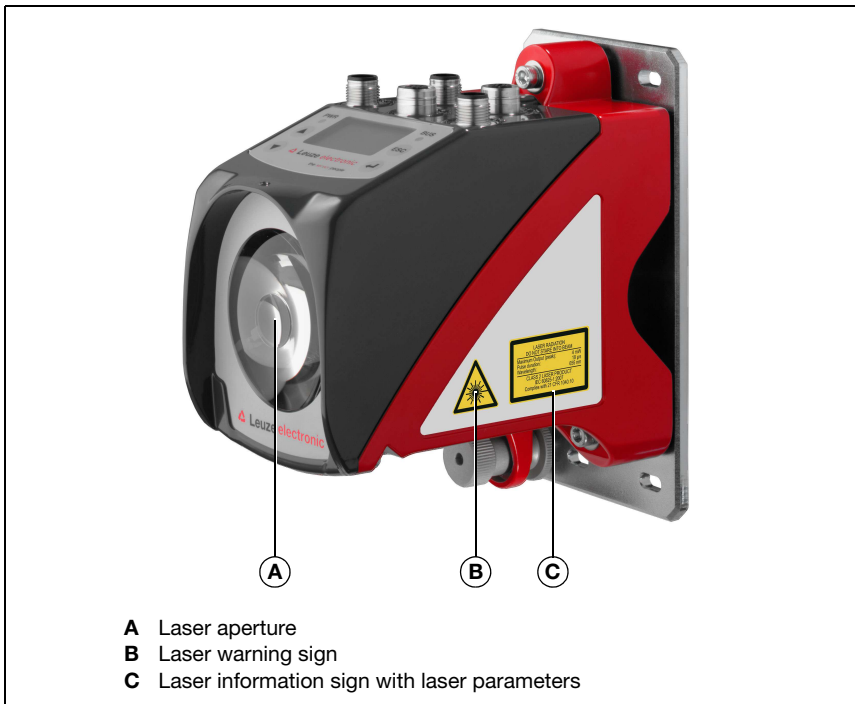

Figure 2.1: Laser apertures, laser warning signs

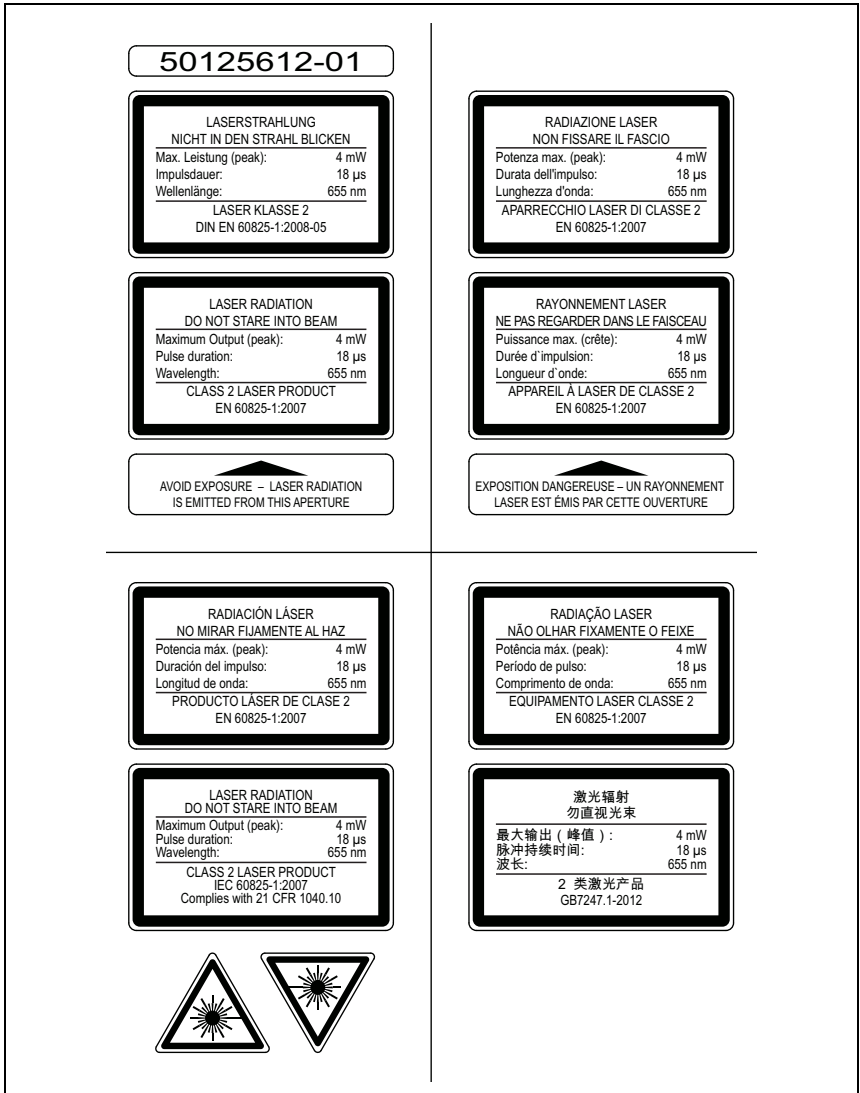

Figure 2.2: Laser warning and information signs – supplied stick-on labels

### 3 Fast commissioning / operating principle

**Notice!**

Below, you will find a **short description for the initial commissioning** of the AMS 335*i*. Detailed explanations for the listed points can be found throughout the handbook.

#### 3.1 Mounting the AMS 335*i*

The AMS 335*i* and the corresponding reflector are mounted on two mutually opposing, plane-parallel, flat walls.

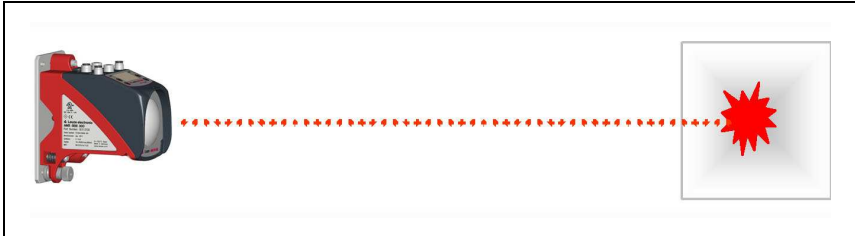

Figure 3.1: Schematic illustration of mounting

**Attention!**

For error-free position measurement, there must be an unobstructed line-of-sight between the AMS 335*i* and the reflector.

##### 3.1.1 Mounting the device

The laser is mounted using 4 screws (M5).

Alignment is performed using 2 adjustment screws. Adjust so that the laser light spot is positioned at the center of the reflector. The alignment is to be secured with the knurled nut and locked with the M5 nut.

**Further information can be found in chapter 5.2 and chapter 5.3.**

##### 3.1.2 Mounting the reflector

The reflector is mounted using 4 screws (M5). The reflector is angled using the spacer sleeves included. Incline the reflector by approx. 1°.

**Detailed information can be found in chapter 6.4.**



### 3.2 Connecting the voltage supply

The laser measurement system is connected using M12 connectors. The voltage supply is connected via the PWR M12 connection.

**Detailed information can be found in chapter 7.**

### 3.3 Display

Once the laser measurement system is supplied with voltage, the device status as well as the measured position values can be read on the display. The display automatically switches to the display of the measurement values.

Use the up/down buttons   to the left of the display to read and change a wide range of data and parameters.

Depending on connected interface, the network address must be configured via the display.

**Detailed information can be found in chapter 8.**

### 3.4 AMS 335*i* on the CANopen

Install the EDS file corresponding to the AMS 335*i* ... in your planning tool/the control (e.g., TwinCAT).



#### **Notice!**

You can find the EDS file at [www.leuze.com](http://www.leuze.com).

The AMS 335*i* is configured in the planning tool/control by means of the EDS file. If the AMS 335*i* has been assigned an address in the planning tool, the address (Node ID) is to be set on the AMS 335*i* via the control panel/display. Only if the addresses are the same between the AMS 335*i* and the control can communication be established.

After all parameters have been set in the planning tool/control, the download to the AMS 335*i* takes place. The set parameters are now stored on the AMS 335*i*.

Afterwards, all changed AMS 335*i* parameters should be stored in the control upon start-up. This aids in retaining the parameters during device exchanges, as they are now also stored centrally in the control.

Each time a connection is established between the control and the AMS 335*i*, these parameters are now transferred again to the AMS 335*i*. Note that this function must be supported by the control.

The CANopen baud rate is defined for the entire network in the planning tool/control.

The baud rate is set on the AMS 335*i* via the control panel/display.

Only if the baud rates are the same is communication with the AMS 335*i* possible.

**Detailed information can be found in chapter 9.**



## 4 Specifications

### 4.1 Specifications of the laser measurement system

#### 4.1.1 General specifications AMS 335*i*

Measurement data	AMS 335 <i>i</i> 40 (H)	AMS 335 <i>i</i> 120 (H)	AMS 335 <i>i</i> 200 (H)	AMS 335 <i>i</i> 300 (H)
Measurement range	0.2 ... 40m	0.2 ... 120m	0.2 ... 200m	0.2 ... 300m
Accuracy	± 2mm	± 2mm	± 3mm	± 5mm
Consistency <sup>1)</sup>	0.3mm	0.5mm	0.7mm	1.0mm
Light spot diameter	≤ 40mm	≤ 100mm	≤ 150mm	≤ 225mm
Measurement value output			1.7ms	
Integration time			8ms	
Resolution		adjustable, see chapter of the individual interfaces		
Temperature drift		≤ 0.1 mm/K		
Ambient temperature sensitivity		1 ppm/K		
Air pressure sensitivity		0.3 ppm/hPa		
Traverse rate		≤ 10 m/s		
<b>Electrical data</b>				
Supply voltage $V_{in}$ <sup>2)</sup>		18 ... 30VDC		
Current consumption		without device heating: ≤ 250mA / 24VDC with device heating: ≤ 500mA / 24VDC		
<b>Optical data</b>				
Transmitter		laser diode, red light, wavelength 650 ... 690nm		
Laser class		2 acc. to EN 60825-1, CDRH		
<b>Interfaces</b>				
CANopen (baud rate in kbit/s)		20 / 50 / 125 (default) / 250 / 500 / 800 / 1000		
Vendor ID		0x121 <sub>H</sub> or 289 <sub>Dec</sub>		
Device type		0x00080196 (absolute linear encoder)		
<b>Operating and display elements</b>				
Keyboard		4 buttons		
Display		monochromatic graphical display, 128 x 64 pixels		
LED		2 LEDs, two-colored		

Inputs/outputs

Quantity	2, programmable
Input	protected against polarity reversal
Output	max. 60 mA, short-circuit proof

**Mechanical data**

Housing	cast zinc and aluminum
Optics	glass
Weight	approx. 2.45 kg
Protection class	IP 65 acc. to EN 60529 <sup>3)</sup>

**Environmental conditions**

Operating temperature	
without device heating	-5 °C ... +50 °C
with device heating	-30 °C ... +50 °C <sup>4)</sup>
Storage temperature	-30 °C ... +70 °C
Air humidity	max. 90% rel. humidity, non-condensing

**Mechanical/electrical loading capacity**

Vibrations	acc. to EN 60068-2-6
Noise	acc. to EN 60060-2-64
Shock	acc. to EN 60068-2-27
EMC	acc. to EN 61000-6-2 and EN 61000-6-4 <sup>5)</sup>

- 1) Statistical error: 1 sigma; minimum switch-on time: 2 min.
- 2) For UL applications: only for use in "Class 2" circuits acc. to NEC.
- 3) With screwed-on M12 plugs or mounted caps.
- 4) With devices with heating, the switch on/off area of the internal heating can be extended to prevent condensation from forming. A 100% prevention of the formation of condensation cannot be guaranteed due to the limited heating capacity of the AMS 335*i*.
- 5) This is a Class A product. In a domestic environment this product may cause radio interference, in which case the operator may be required to take adequate measures.



The AMS 335*i* is designed in accordance with safety class III for supply with PELV (protective extra-low voltage).

4.1.2 Dimensioned drawing AMS 335*i*

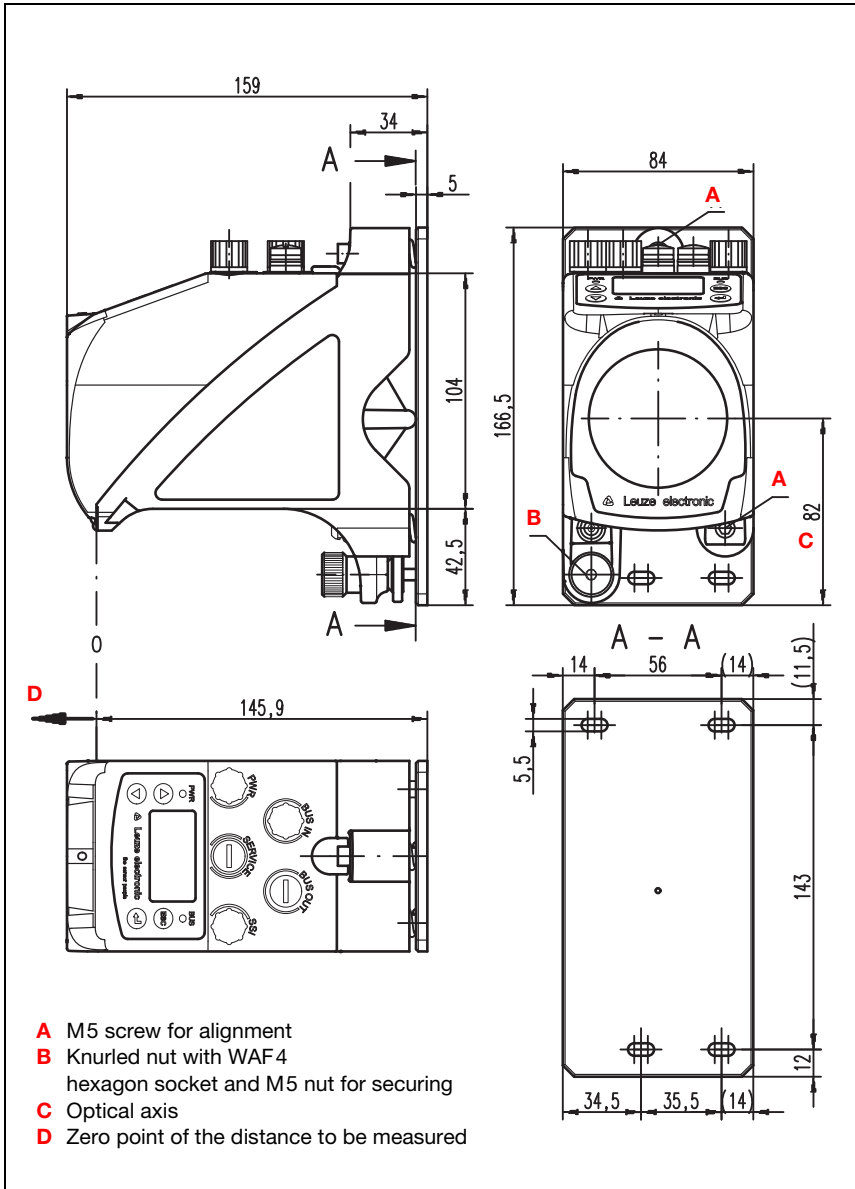

Figure 4.1: Dimensioned drawing AMS 335*i*

### 4.1.3 Type overview AMS 335*i*

#### *AMS 335i (CANopen)*

Type designation	Description	Part no.
AMS 335/40	40 m operating range, CANopen interface	50113693
AMS 335/120	120 m operating range, CANopen interface	50113694
AMS 335/200	200 m operating range, CANopen interface	50113695
AMS 335/300	300 m operating range, CANopen interface	50113696
AMS 335/40 H	40 m operating range, CANopen interface, integrated heating	50113697
AMS 335/120 H	120 m operating range, CANopen interface, integrated heating	50113698
AMS 335/200 H	200 m operating range, CANopen interface, integrated heating	50113699
AMS 335/300 H	300 m operating range, CANopen interface, integrated heating	50113700

Table 4.1: Type overview AMS 335*i*

## 5 Installation and mounting

### 5.1 Storage, transportation



#### Attention!

When transporting or storing, package the device so that it is protected against collision and humidity. Optimum protection is achieved when using the original packaging. Heed the required environmental conditions specified in the technical data.

#### Unpacking

- ✎ Check the packaging for any damage. If damage is found, notify the post office or shipping agent as well as the supplier.
- ✎ Check the delivery contents using your order and the delivery papers:
  - Delivered quantity
  - Device type and model as indicated on the nameplate
  - Brief manual

The name plate provides information as to what AMS 335*i* type your device is. For specific information, please refer to chapter 11.1.1.

#### Name plates

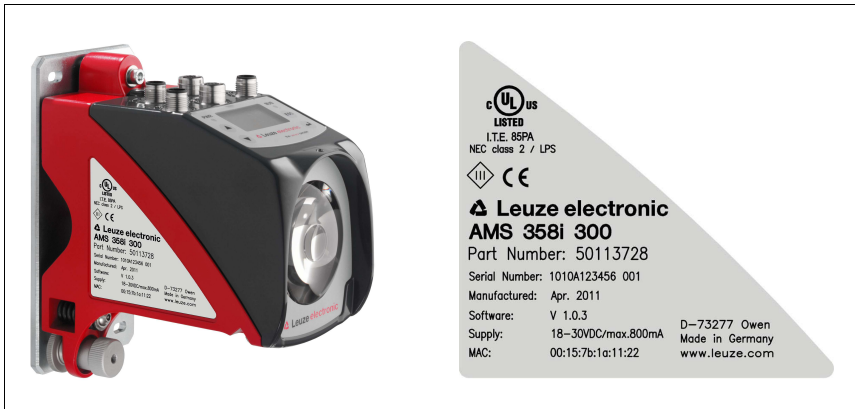

Figure 5.1: Device name plate using the AMS 300*i* as an example



#### Notice!

Please note that the shown name plate is for illustration purposes only; the contents do not correspond to the original.

- ✎ Save the original packaging for later storage or shipping.

If you have any questions concerning your shipment, please contact your supplier or your local Leuze electronic sales office.

↳ Observe the applicable local regulations when disposing of the packaging materials.

## 5.2 Mounting the AMS 335*i*

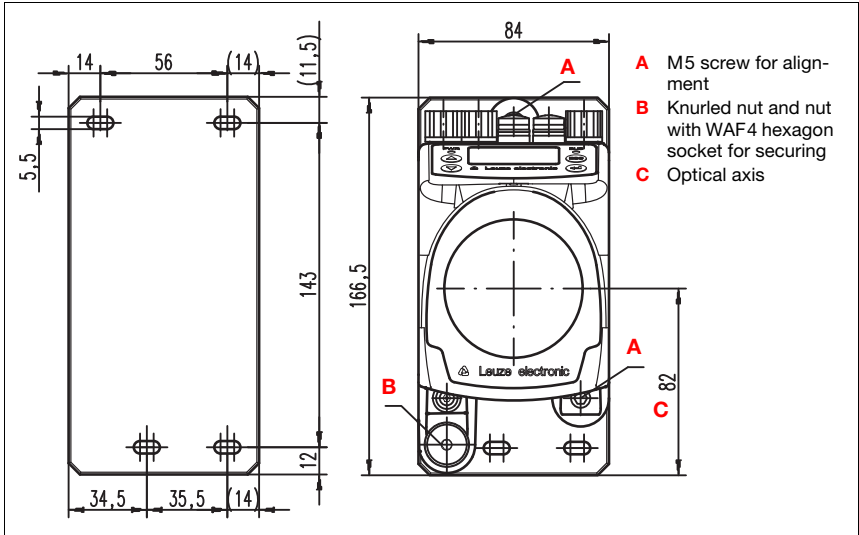

Figure 5.2: Mounting the device

The AMS 335*i* and the corresponding reflector are mounted on two mutually opposing, plane-parallel, flat walls or system parts. For error-free position measurement, there must be an unobstructed line-of-sight connection between the AMS 335*i* and the reflector.

Use M5 screws to fasten the laser measurement system. Secure the screws with a toothed lock washer to protect against loosening caused by vibrations.

### ***Aligning the laser light spot in the center of the reflector***

The laser light spot has to be aligned so that it always hits the center of the opposing reflector, both at close range as well as at the maximum measurement distance. **To align, use the two M5 Allen screws** ("A" in figure 5.2). When aligning please ensure that the knurled nut and the lock nut ("B" in figure 5.2) are opened wide.



#### ***Attention!***

*To prevent the laser measurement system from moving out of alignment during continuous operation, subsequently hand-tighten the knurled nut and counterlock with the nut with WAF4 hexagon socket ("B" in figure 5.2). Knurled nut and nut must not be tightened until alignment has been completed.*



#### ***Attention!***

*The device must not be opened. Failure to comply will render the guarantee void. Warranted features cannot be guaranteed after the device has been opened.*

**5.2.1 Optional mounting bracket**

A mounting bracket for mounting the AMS 335*i* on a flat, horizontal surface is available as an optional accessory.

Type designation: MW OMS/AMS 01

Part no.: 50107255

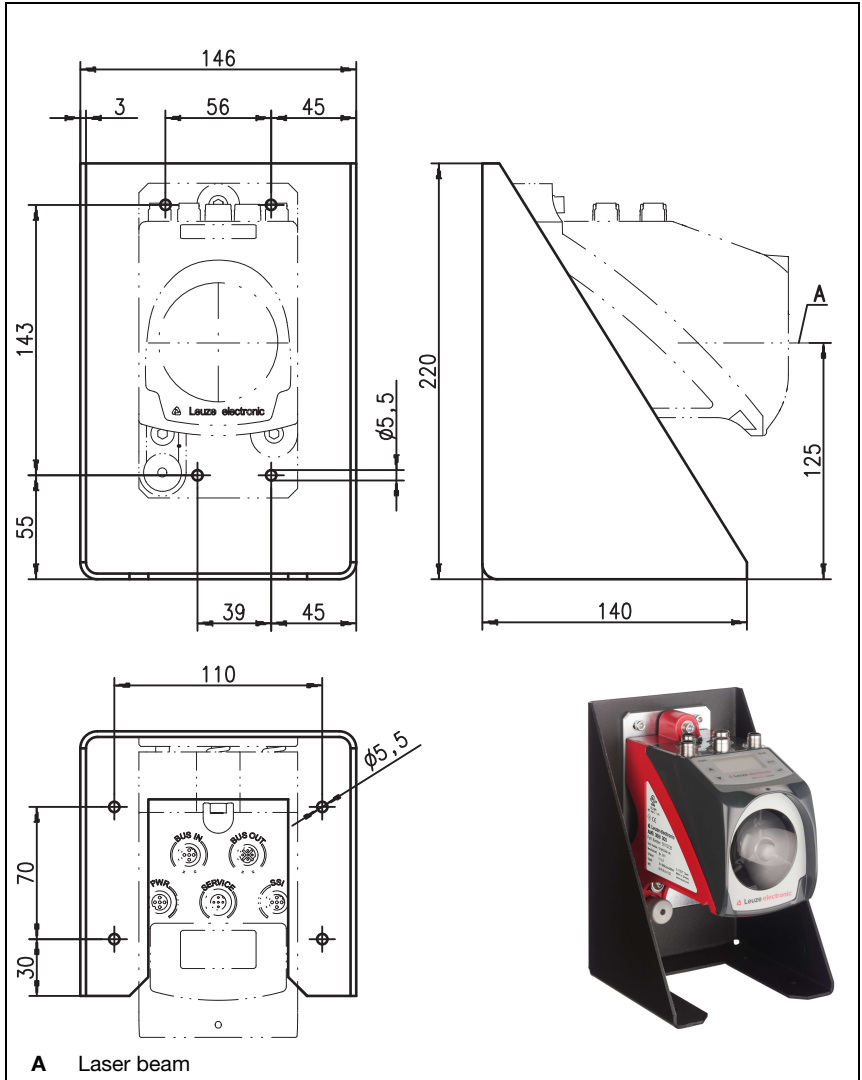

Figure 5.3: Optional mounting bracket



5.2.2 Parallel mounting of the AMS 335*i*

**Definition of the term "parallel spacing"**

As shown in figure 5.4, dimension X describes the "parallel spacing" of the inner edges of the two laser light spots on the reflector.

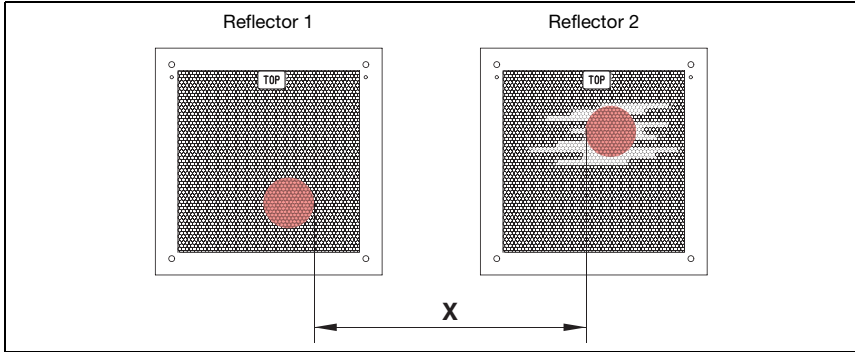

Figure 5.4: Minimum parallel spacing X between adjacent AMS 335*i*

The diameter of the light spot increases with distance.

	AMS 335 <i>i</i> 40 (H)	AMS 335 <i>i</i> 120 (H)	AMS 335 <i>i</i> 200 (H)	AMS 335 <i>i</i> 300 (H)
Max. measurement distance	40m	120m	200m	300m
Light spot diameter	≤ 40mm	≤ 100mm	≤ 150mm	≤ 225mm

Thus, the center-to-center spacing of the two AMS 335*i* devices with respect to one another can be calculated as a function of the maximum measurement distance.

To define the minimum parallel spacing between two AMS 335*i*, it is necessary to distinguish between three different arrangements of AMS 335*i* and reflectors.

**The AMS 335*i* are mounted stationary and in parallel on one plane.**

**Both reflectors move independently of one another at different distances to the AMS 335*i*.**

Minimum parallel spacing X of the two laser light spots:

$$X = 100\text{mm} + (\text{max. measurement distance in mm} \times 0.01)$$

**The AMS 335*i* are mounted stationary and in parallel on one plane.**

**Both reflectors move in parallel at the same distance to the AMS 335*i*.**

Measurement distance **up to 120m**: minimum parallel spacing **X ≥ 600mm**

Measurement distance **up to 200m**: minimum parallel spacing **X ≥ 750mm**

Measurement distance **up to 300m**: minimum parallel spacing **X ≥ 750mm**

***The reflectors are mounted stationary and in parallel on one plane.***

***Both AMS 335*i* move independently of one another at different or the same distances to the reflectors.***

Measurement distance **up to 120m**: minimum parallel spacing **X ≥ 600mm**

Measurement distance **up to 200m**: minimum parallel spacing **X ≥ 750mm**

Measurement distance **up to 300m**: minimum parallel spacing **X ≥ 750mm**



***Notice!***

*Please note that when the AMS 335*i* are mounted in a mobile manner, travel tolerances could cause the two laser light spots to move towards each other.*

*Take the travel tolerances of the vehicle into account when defining the parallel spacing of adjacent AMS 335*i*.*

### **5.2.3 Parallel mounting of AMS 335*i* and DDLS optical data transmission**

The optical data transceivers of the DDLS series and the AMS 335*i* do not interfere with one another. Depending on the size of the used reflector, the DDLS can be mounted with a minimum parallel spacing of 100mm to the AMS 335*i*. The parallel spacing is independent of the distance.

### 5.3 Mounting the AMS 335*i* with laser beam deflector unit

#### General information

The two available deflector units are used for the 90° deflection of the laser beam, see "Accessory deflector unit" on page 93.



#### Attention!

The deflector units are designed for a maximum range of 40m. Longer distances on request.

#### 5.3.1 Mounting the laser beam deflector unit With integrated mounting bracket

The AMS 335*i* is screwed onto the mechanism of the US AMS 01 deflector unit. The mirror can be mounted for three deflection directions:

1. Upward beam deflection
2. Beam deflection to the left
3. Beam deflection to the right

The deflector unit is mounted on plane-parallel, flat walls or plant components. For error-free position measurement, there must be an interruption-free line-of-sight between the AMS 335*i*... and the deflection mirror as well as between the mirror and the reflector.

Use the M5 screws to mount the deflector unit. Secure the screws with a toothed lock washer to protect against loosening caused by vibrations.

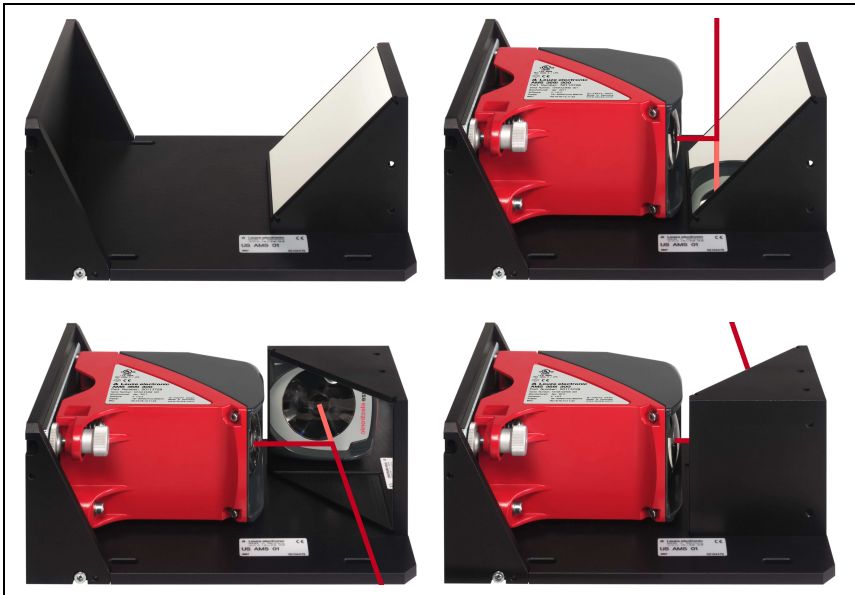

Figure 5.5: Mounting variants of the US AMS 01 laser beam deflector unit

**5.3.2 Dimensioned drawing of US AMS 01 deflector unit**

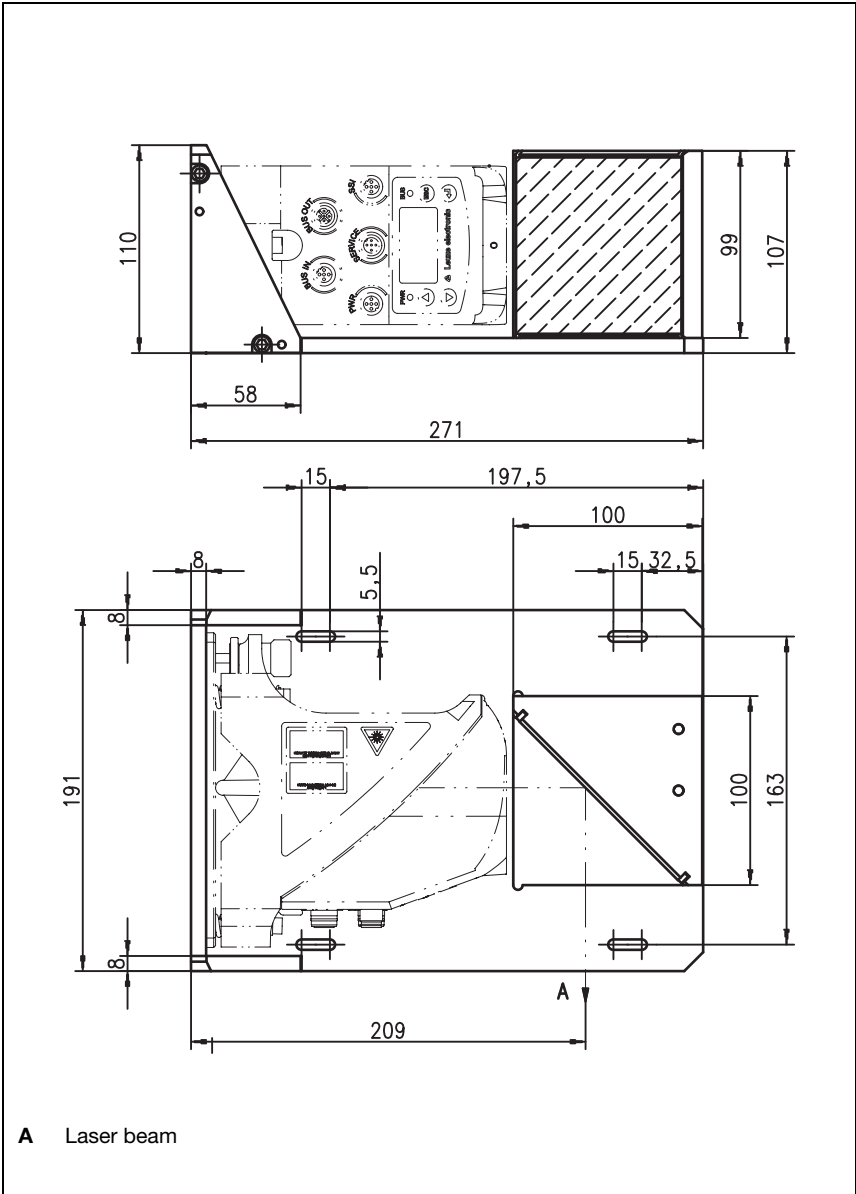

Figure 5.6: Dimensioned drawing of US AMS 01 deflector unit

### 5.3.3 Mounting the US 1 OMS deflector unit without mounting bracket

The US 1 OMS deflector unit and the AMS 335*i* are mounted separately.



**Notice!**

When mounting, make certain that the laser light spot of the AMS 335*i* is aligned in the center of the deflection mirror.

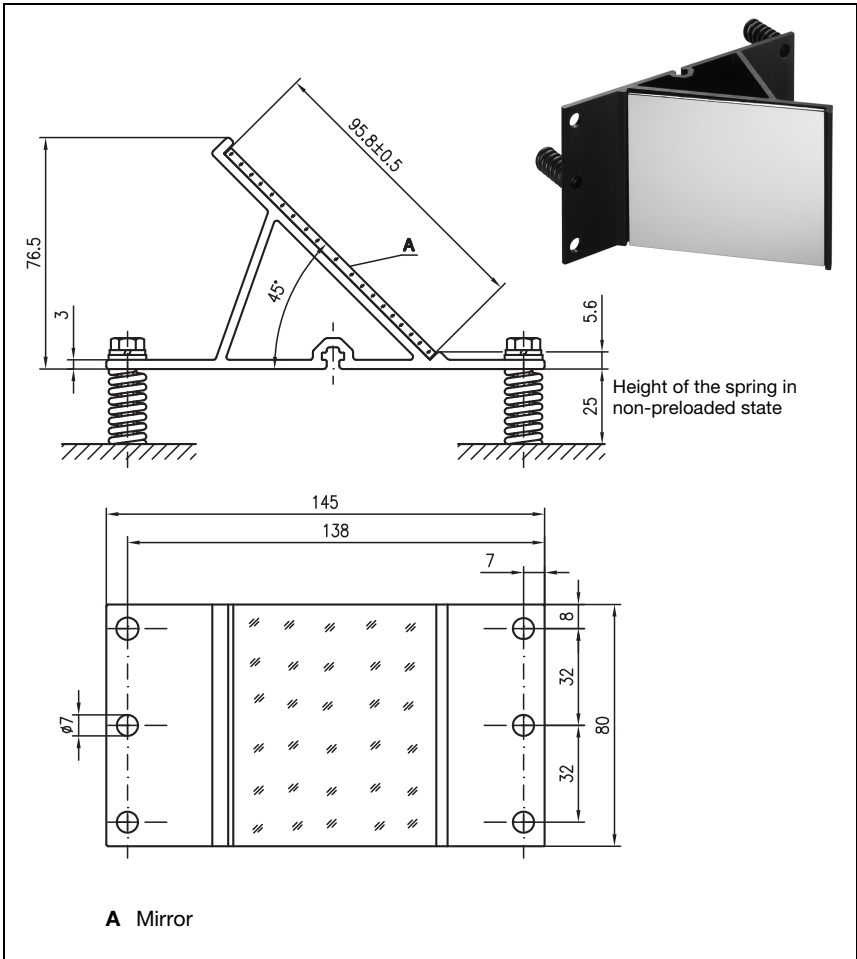

Figure 5.7: Photo and dimensioned drawing of the US 1 OMS deflector unit

Alignment of the laser light spot on the reflector is performed as described in chapter 5.2.

## 6 Reflectors

### 6.1 General information

The AMS 335*i* measures distances against a reflective tape specified by Leuze electronic. All provided specifications for the AMS 335*i*, such as the operating range or accuracy, can only be achieved with the reflective tape specified by Leuze electronic.

The reflective tapes are available as adhesive tapes, affixed to a metal plate and with an integrated heater especially for use at low temperatures. Reflective tapes with heating have the designation "**Reflective tape ...x...-H**", where "**H**" is an abbreviation for the heating variant.

The reflective tapes/reflectors must be ordered separately. The choice of size is left to the user. In chapter 6.3, recommendations on reflector size are provided as a function of the distance that is to be measured. In any case, the user must check to determine whether the recommendation is suitable for the respective application.

### 6.2 Description of the reflective tape

The reflective tape consists of a white, microprism-based reflective material. The microprisms are protected with a highly transparent, hard protective layer.

Under certain circumstances, the protective layer may lead to surface reflections. The surface reflections can be directed past the AMS 335*i* by positioning the reflective tape at a slight incline. The inclination of the reflective tape/reflectors is described in chapter 6.4.2. The required pitch can be found in table 6.1 "Reflector pitch resulting from spacer sleeves" on page 36.

The reflective tapes are provided with a protective foil that can easily be pulled off. This must be removed from the reflector before the complete system is put into operation.

### 6.2.1 Specifications of the self-adhesive foil

Type designation	Part		
	Reflective tape 200x200-S	Reflective tape 500x500-S	Reflective tape 914x914-S
Part no.	50104361	50104362	50108988
Foil size	200x200mm	500x500mm	914x914mm
Recommended application temperature for adhesive tape	+5 °C ... +25 °C		
Temperature resistance, affixed	-40 °C ... +80 °C		
Mounting surface	The mounting surface must be clean, dry and free of grease.		
Cutting the tape	Cut with a sharp tool, always on the side of the prism structure.		
Cleaning	Do not use any agents that act with a grinding effect. A conventional household detergent can be used as a cleaning agent. Rinse with clear water and dry the surface.		
Storing the foil	Store in a cool and dry place.		

### 6.2.2 Specifications of the reflective tape on a metal plate

The reflective tape is affixed to a metal plate. Included with the metal plate are spacers for positioning at an incline - for avoiding surface reflections - (see chapter 6.4.2 "Mounting the reflector").

Type designation	Part		
	Reflective tape 200x200-M	Reflective tape 500x500-M	Reflective tape 914x914-M
Part no.	50104364	50104365	50104366
Foil size	200x200mm	500x500mm	914x914mm
Outer dimensions of the metal plate	250x250mm	550x550mm	964x964mm
Weight	0.8 kg	4 kg	25 kg
Cleaning	Do not use any agents that act with a grinding effect. A conventional household detergent can be used as a cleaning agent. Rinse with clear water and dry the surface.		
Storing the reflector	Store in a cool and dry place.		

6.2.3 Dimensioned drawing of reflective tape on a metal plate

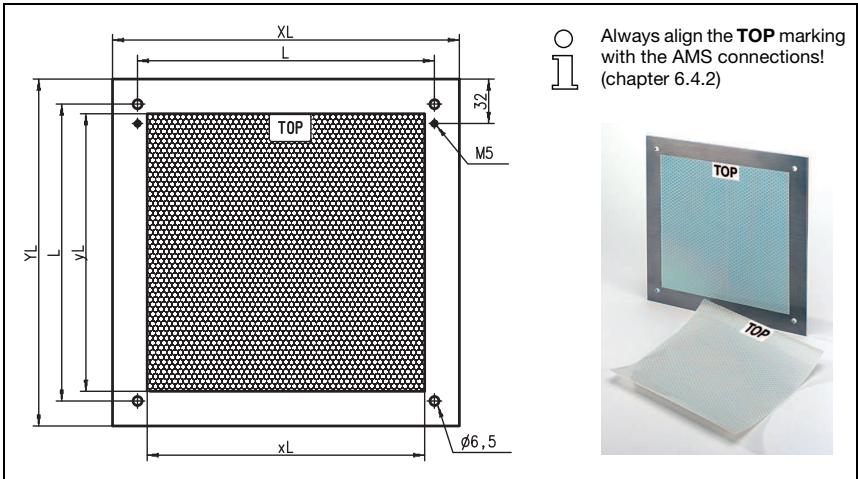

Figure 6.1: Dimensioned drawing of reflectors

Part	Reflective tape (mm)		Reflector plate (mm)		
	xL	yL	XL	YL	L
Reflective tape 200x200-M	200	200	250	250	214
Reflective tape 500x500-M	500	500	550	550	514
Reflective tape 914x914-M	914	914	964	964	928



### 6.2.4 Specifications of heated reflectors

The reflective tape is affixed to a heated, thermally insulated base. The insulation results in a very high energetic efficiency.

Only the reflective tape is kept at the specified temperature by the integrated heater. Through the insulation on the back, the generated heat cannot be transferred via the steel construction. Energy costs are greatly reduced in the case of continuous heating.

Type designation	Part		
	Reflective tape 200x200-H	Reflective tape 500x500-H	Reflective tape 914x914-H
Part no.	50115020	50115021	50115022
Voltage supply	230VAC		
Power	100W	600W	1800W
Current consumption	~ 0.5A	~ 3A	~ 8A
Length of the supply line	2 m		
Size of the reflective tape	200x200mm	500x500mm	914x914mm
Outer dimensions of the base material	250x250mm	550x550mm	964x964mm
Weight	0.5kg	2.5kg	12kg
Temperature control	Controlled heating with the following switch-on and switch-off temperatures, measured at the reflector surface.		
Switch-on temperature	~ 5°C		
Switch-off temperature	~ 20°C		
Operating temperature	-30°C ... +70°C		
Storage temperature	-40°C ... +80°C		
Air humidity	Max. 90%, non-condensing.		
Cleaning	Do not use any agents that act with a grinding effect. A conventional household detergent can be used as a cleaning agent. Rinse with clear water and dry the surface.		
Storing the reflector	Store in a cool and dry place.		

6.2.5 Dimensioned drawing of heated reflectors

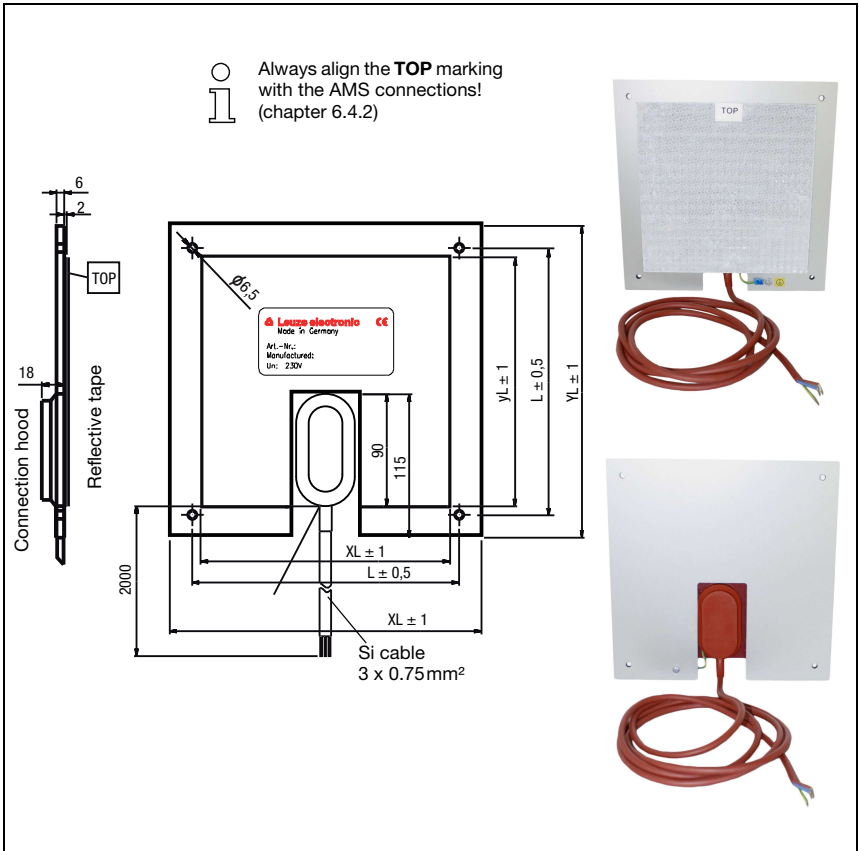

Figure 6.2: Dimensioned drawing of heated reflectors

Part	Reflective tape (mm)		Insulated base plate (mm)		
	xL	yL	XL	YL	L
Reflective tape 200x200-H	200	200	250	250	214
Reflective tape 500x500-H	500	500	550	550	514
Reflective tape 914x914-H	914	914	964	964	928

### 6.3 Selecting reflector sizes

Depending on system design, the reflector can be mounted so that it travels on the vehicle or it can be mounted at a fixed location.



**Attention!**

The reflector sizes shown below are a recommendation from Leuze electronic for on-vehicle mounting of the AMS 335*i*. For stationary mounting of the AMS 335*i*, a smaller reflector is generally sufficient for all measurement distances.

On the basis of the system planning and design, always check whether mechanical travel tolerances may require the use of a reflector larger than that which is recommended. This applies, in particular, when the laser measurement system is mounted on a vehicle. During travel, the laser beam must reach the reflector without interruption. For on-vehicle mounting of the AMS 335*i*, the reflector size must accommodate any travel tolerances that may arise and the associated "wandering" of the light spot on the reflector.

**Overview of reflector types**

Recommended reflector sizes			
AMS 335 <i>i</i> selection (Operating range in m)	Recommended reflector size (H x W)	Type designation ...-S = Self-adhesive ...-M = metal plate ...-H = heating	Part no.
AMS 335 <i>i</i> 40 (max. 40m)	200x200mm	Reflective tape 200x200-S Reflective tape 200x200-M Reflective tape 200x200-H	50104361 50104364 50115020
AMS 335 <i>i</i> 120 (max. 120m)	500x500mm	Reflective tape 500x500-S Reflective tape 500x500-M Reflective tape 500x500-H	50104362 50104365 50115021
AMS 335 <i>i</i> 200 (max. 200m)	749x914mm 914x914mm	Reflective tape 749x914-S Reflective tape 914x914-M Reflective tape 914x914-S Reflective tape 914x914-H	50104363 50104366 50108988 50115022
AMS 335 <i>i</i> 300 (max. 300m)	749x914mm 914x914mm	Reflective tape 749x914-S Reflective tape 914x914-M Reflective tape 914x914-S Reflective tape 914x914-H	50104363 50104366 50108988 50115022

## 6.4 Mounting the reflector

### 6.4.1 General information

#### **Self-adhesive reflective tapes**

The reflective tapes of the "Reflective tape ...x...-S" self-adhesive series must be affixed to a flat, clean and grease-free surface. We recommend using a separate metal plate, which is to be provided on-site.

As described in table 6.1, the reflective tape must be angled.

#### **Reflective tapes on metal**

The reflective tapes of the "Reflective tape ...x...-M" series are provided with corresponding mounting holes. Spacer sleeves are provided in the packet for achieving the necessary pitch angle. For further information see table 6.1.

#### **Heated reflectors**

The reflective tapes of the "Reflective tape ...x...-H" series are provided with corresponding mounting holes. Due to the voltage supply affixed on the rear, the reflector cannot be mounted flat. Included in the package are four distance sleeves in two different lengths. Use the distance sleeves to achieve a base separation to the wall as well as the necessary pitch for avoiding surface reflection. For further information see table 6.1.

The reflector is provided with a 2m-long connection cable for supplying with 230VAC. Connect the cable to the closest power outlet. Observe the current consumptions listed in the specifications.



#### **Attention!**

*Connection work must be carried out by a certified electrician.*

### 6.4.2 Mounting the reflector

The combination of laser measurement system and reflective tape/reflector is mounted so that the laser light spot hits the tape as centered as possible and without interruption.

For this purpose, use the alignment elements provided on the AMS 335*i*... (see chapter 5.2 "Mounting the AMS 335*i*"). If necessary, remove the protective foil from the reflector.



#### **Attention!**

The "TOP" label mounted on the reflectors should be aligned the same as the connections of the AMS 335*i*.

#### **Example:**

*If the AMS 335*i* is mounted so that the M12 connections are on the top, the "TOP" label of the reflector is also on the top. If the AMS 335*i* is mounted so that the M12 connections are on the side, the "TOP" label of the reflector is also on the side.*



**Notice!**

The reflector must be angled. To do this, use the spacer sleeves. Angle the reflectors so that the **surface reflections of the foil seal are deflected to the left, right or upwards**, chapter 6.4.3 gives the correct pitch with respect to the reflector size and, thus, the length of the spacers.

**Reflective tapes ...-S and ...-M**

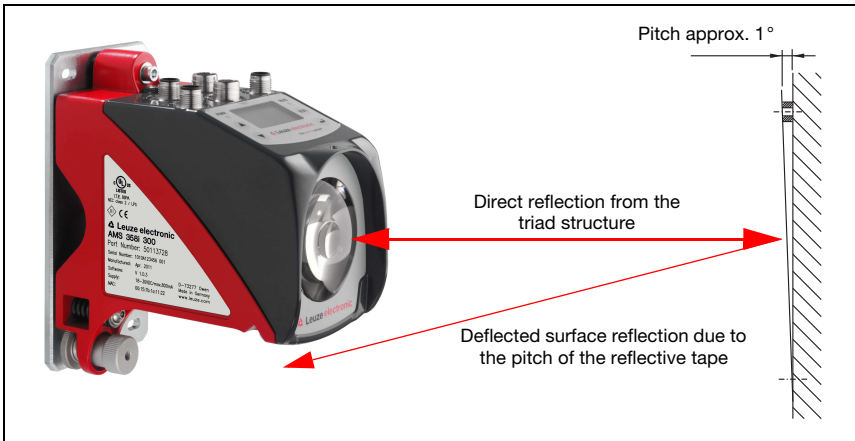

Figure 6.3: Reflector mounting

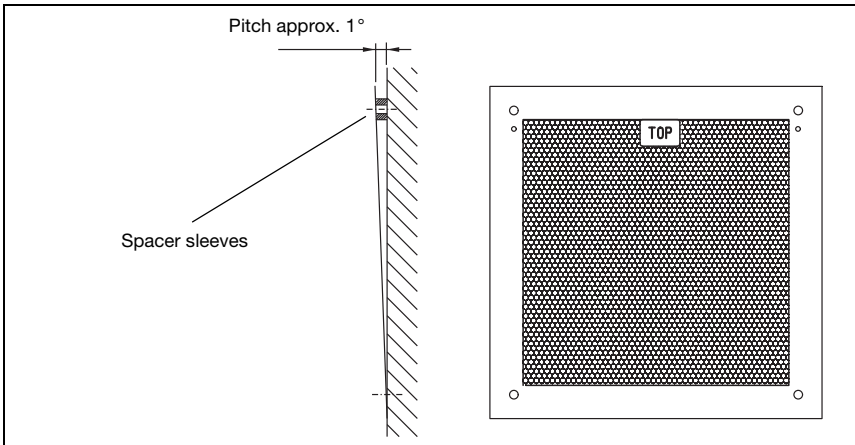

Figure 6.4: Pitch of the reflector

Reflective tapes ...-H

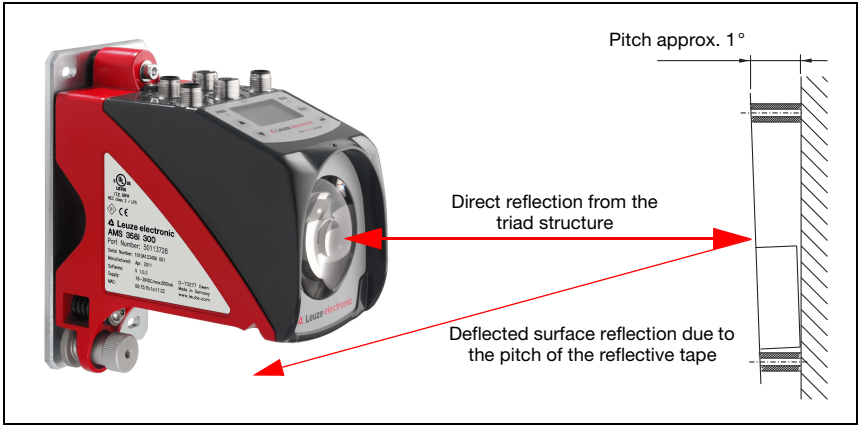

Figure 6.5: Mounting of heated reflectors

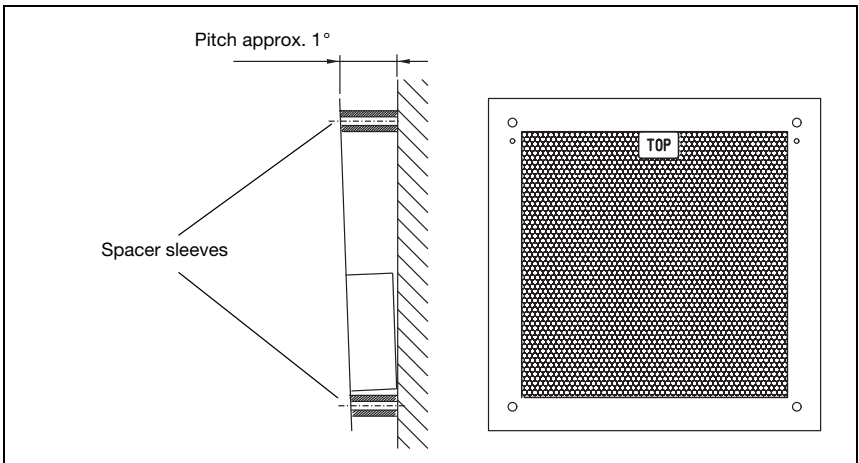

Figure 6.6: Pitch of the heated reflector

6.4.3 Table of reflector pitches

Reflector type	Pitch resulting from spacer sleeves <sup>1)</sup>	
Reflective tape 200x200-S Reflective tape 200x200-M	2 x 5 mm	
Reflective tape 200x200-H	2 x 15 mm	2 x 20 mm
Reflective tape 500x500-S Reflective tape 500x500-M	2 x 10 mm	
Reflective tape 500x500-H	2 x 15 mm	2 x 25 mm
Reflective tape 749x914-S	2 x 20 mm	
Reflective tape 914x914-S Reflective tape 914x914-M	2 x 20 mm	
Reflective tape 914x914-H	2 x 15 mm	2 x 35 mm

1) Spacer sleeves are included in the delivery contents of reflective tape ...-M and ...-H

Table 6.1: Reflector pitch resulting from spacer sleeves



**Notice!**

Reliable function of the AMS 335*i* and, thus, max. operating range and accuracy can only be achieved with the reflective tape specified by Leuze electronic. No function can be guaranteed if other reflectors are used!

## 7 Electrical connection

The AMS 335*i* laser measurement systems are connected using variously coded M12 connectors. This ensures unique connection assignments.



**Notice!**

The corresponding mating connectors and ready-made cables are available as accessories for all cables. For further information, see chapter 11 "Type overview and accessories".



Figure 7.1: Connections of the AMS 335*i*

### 7.1 Safety notices for the electrical connection



**Attention!**

Before connecting the device, be sure that the supply voltage agrees with the value printed on the name plate.

The device may only be connected by a qualified electrician.

Ensure that the functional earth (FE) is connected correctly. Unimpaired operation is only guaranteed when the functional earth is connected properly.

If faults cannot be corrected, the device should be removed from operation and protected against possible use.



**Attention!**

For UL applications, use is permitted exclusively in Class 2 circuits according to NEC (National Electric Code).



The laser measurement systems are designed in accordance with safety class III for supply by PELV (protective extra-low voltage with reliable disconnection).



**Notice!**

Protection class IP65 is achieved only if the connectors and caps are screwed into place!



Described in detail in the following are the individual connections and pin assignments.

## 7.2 PWR – voltage supply / switching input/output

PWR (5-pin plug, A-coded)			
	Pin	Name	Remark
	1	VIN	Positive supply voltage +18 ... +30VDC
	2	I/O 1	Switching input/output 1
	3	GND	Negative supply voltage 0VDC
	4	I/O 2	Switching input/output 2
	5	FE	Functional earth
	Thread	FE	Functional earth (housing)

Table 7.1: Pin assignment PWR

Further information on configuring the input/output can be found in chapter 8 and chapter 9.

## 7.3 CANopen BUS IN

BUS IN (5-pin plug, A-coded)			
	Pin	Name	Remark
	1	Drain	Shield
	2	NC	Not used
	3	NC	Not used
	4	CAN_H	Data signal CAN_H
	5	CAN_L	Data signal CAN_L
	Thread	FE	Functional earth (housing)

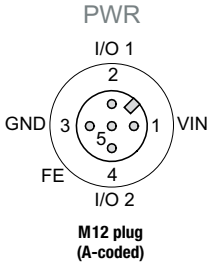
Table 7.2: Pin assignments for CANopen BUS IN

### 7.4 CANopen BUS OUT

BUS OUT (5-pin socket, A-coded)			
 <p>BUS OUT</p> <p>M12 socket (A-coded)</p>	Pin	Name	Remark
	1	Drain	Shield
	2	NC	Not used
	3	NC	Not used
	4	CAN_H	Data signal CAN_H
	5	CAN_L	Data signal CAN_L
	Thread	FE	Functional earth (housing)

Table 7.3: Pin assignments for CANopen BUS OUT

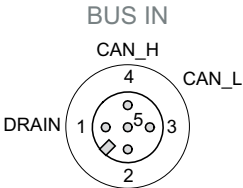
### 7.5 Service

Service (5-pin socket, A-coded)			
 <p>SERVICE</p> <p>M12 socket (A-coded)</p>	Pin	Name	Remark
	1	NC	Not used
	2	RS232-TX	Transmission line RS 232/service data
	3	GND	Voltage supply 0VDC
	4	RS232-RX	Receiving line RS 232/service data
	5	NC	Not used
	Thread	FE	Functional earth (housing)

Table 7.4: Service pin assignments

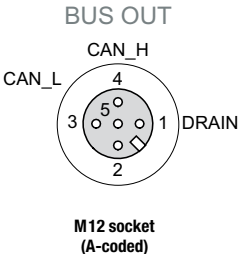

**Notice!**

The service interface is designed only for use by Leuze electronic!

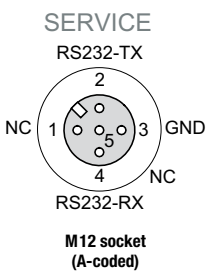
## 8 Display and control panel AMS 335i

### 8.1 Structure of the control panel

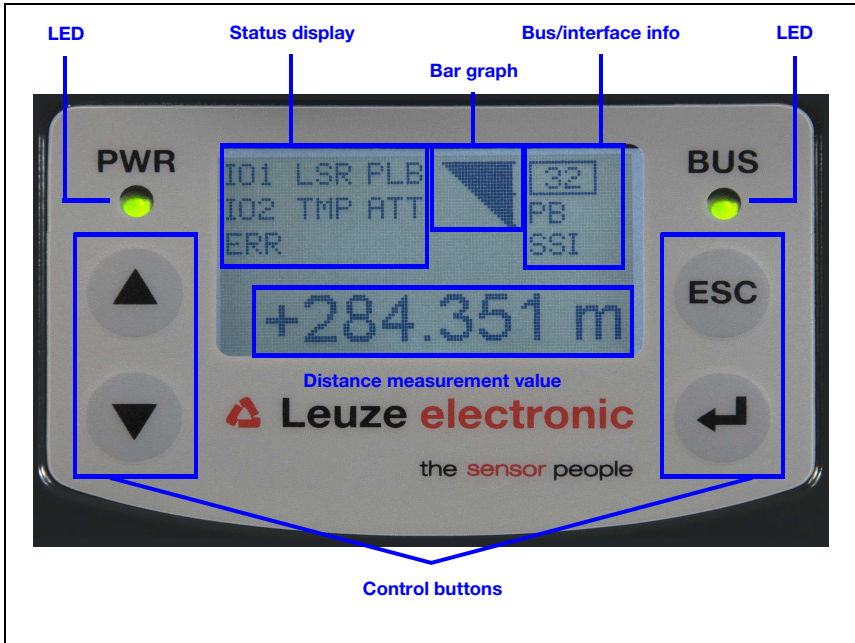

Figure 8.1: Structure of the control panel using the AMS 304i PROFIBUS device variant as an example



**Notice!**

The figure is for illustration purposes only and does not correspond to AMS 335i with respect to bus/interface info.

### 8.2 Status display and operation

#### 8.2.1 Indicators in the display

**Status and warning messages in the display**

- I01 **Input 1 or output 1 active:**  
Function depending on configuration.
- I02 **Input 2 or output 2 active:**  
Function depending on configuration.

- LSR    **Warning - laser prefailure message:**  
Laser diode old, device still functional, exchange or have repaired.
- TMP    **Warning - temperature monitoring:**  
Permissible internal device temperature exceeded / not met.
- PLB    **Plausibility error:**  
Implausible measurement value. Possible causes: light beam interruption, outside of measurement range, permissible internal device temperature considerably exceeded or traverse rate >10m/s.  
Depending on the configuration, either zero or the last valid measurement value is output at the interfaces.
- ATT    **Warning received signal:**  
Laser outlet window or reflector soiled or fogged by rain, water vapor or fog. Clean or dry surfaces.
- ERR    **Internal hardware error:**  
The device must be sent in for inspection.

**Bar graph**



Indicates the **strength of the received laser light**.  
The center bar represents the **ATT** warning threshold. The distance value remains valid and is output at the interfaces.  
If no bar graph is available, the **PLB** status information appears at the same time.  
The measurement value has thus been assessed as being implausible. Depending on the configuration, either zero or the last valid measurement value is output at the interfaces.

**Interface info**

An activated CANopen interface is indicated by the presence of Node ID (bus address) and the "CAN" ID in the display. If the CANopen interface is deactivated, the Node ID and CAN ID are hidden from view.

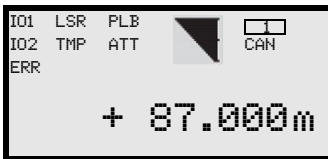

← Bus address  
CAN ID

← Maximum position value

**Maximum position value**

The measured position value is displayed in the configured unit of measurement.

- +87.000m    With the **metric** setting, the measurement value is always displayed in meters with **three decimal places**.
- +87.0in    With the **inch** setting, the measurement value is always displayed in inches with **one decimal place**.

## 8.2.2 LED status displays

### **PWR LED**

PWR



**Off**

**Device OFF**

- No supply voltage

PWR



**Flashing green**

**Power LED flashes green**

- No measurement value output
- Voltage connected
- Self test running
- Initialization running
- Boot process running

PWR



**Green continuous light**

**Power LED green**

- AMS 335*i* ok
- Measurement value output
- Self test successfully finished
- Device monitoring active

PWR



**Red flashing**

**Power LED flashes red**

- Device ok but warning message (ATT, TMP, LSR) set in display
- Light beam interruption
- Plausibility error (PLB)

PWR



**Red continuous light**

**Power LED red**

- No measurement value output; for details, see Display

PWR



**Orange continuous light**

**Power LED orange**

- Parameter enable active
- No data on the host interface

### **BUS LED**





BUS







**Off**

**LED off**



- No voltage supply
- Bus ok

	<b>Flashing green</b>	<b>LED flashes green</b> - "PRE-OPERATIONAL" state - "STOPPED" state
	<b>Green continuous light</b>	<b>LED is green</b> - "OPERATIONAL" state
	<b>Flashing red</b>	<b>LED flashes red</b> - Invalid configuration
	<b>Red continuous light</b>	<b>LED red</b> - No bus connection
	<b>Flashing green/red</b>	<b>LED flashes green/red</b> - Bus error - Time out - RX /TX Buffer overflow - Termination error -

### 8.2.3 Control buttons

	<b>Up</b>	Navigate upward/laterally.
	<b>Down</b>	Navigate downward/laterally.
	<b>ESC</b>	Exit menu item.
	<b>ENTER</b>	Confirm/enter value, change menu levels.

#### ***Navigating within the menus***

The menus within a level are selected with the up/down buttons  .

The selected menu item is activated with the enter button .





Press the ESC button  to move up one menu level.



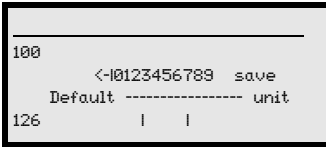

When one of the buttons is actuated, the display illumination is activated for 10min.



**Setting values**

If input of a value is possible, the display looks like this:



-  +  Delete character
-  +  Enter digit
- save +  Save



Use the   and  buttons to set the desired value. An accidental, incorrect entry can be corrected by selecting <-| and then pressing .

Then use the   buttons to select Save and save the set value by pressing .

**Selecting options**

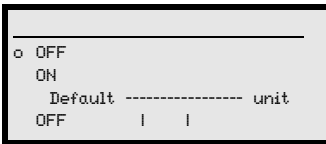
If options can be selected, the display looks like this:



Select the desired option with the   buttons. Activate the option by pressing .

**8.3 Menu description**

**8.3.1 The main menus**

After voltage has been applied to the laser, device information is displayed for several seconds. The display then shows the measurement window with all status information.

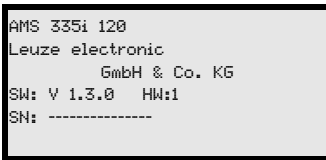

**Device information - main menu**

This menu item contains detailed information on

- Device model,
- Manufacturer,
- Software and hardware version,
- Serial number.

No entries can be made via the display.

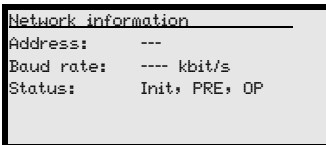

**Network information - main menu**

- Explanations of address, baud rate, status.

No entries can be made via the display.



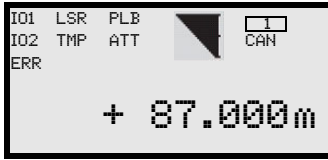

Status and measurement data - main menu

- Display of status-, warning-, and error messages
- Status overview of the switching inputs/outputs.
- Bar graph for the reception level.
- Link.
- Measurement value. No entries can be made via the display. See "Indicators in the display" on page 40.

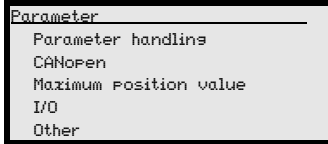

Parameter - main menu

- Configuration of the AMS. See "Parameter menu" on page 45.



Language selection - main menu

- Selection of the display language. See "Language selection menu" on page 49.

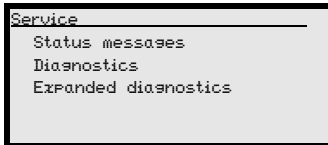

Service - main menu

- Display of status messages.
  - Display of diagnostic data.
- No entries can be made via the display. See "Service menu" on page 49.



**Notice!**

*The rear cover of this manual includes a **fold-out page** with the complete **menu structure**. It describes the menu items in brief.*

**8.3.2 Parameter menu**

**Parameter handling submenu**

The following functions can be called up in the Parameter handling submenu:

- Lock and enable parameter entry
- Set up a password
- Reset the AMS 335i to default settings.

Table 8.1: Parameter handling submenu

Level 3	Level 4	Level 5	Selection/configuration option Description	Standard
Parameter enabling			ON / OFF The standard setting (OFF) prevents unintended parameter changes. With parameter enabling activated (ON), the display is inverted. In this state, it is possible to change parameters manually.	OFF



Table 8.1: Parameter handling submenu

Level 3	Level 4	Level 5	Selection/configuration option Description	Standard
Password	Activate password		ON / OFF To enter a password, parameter enabling must be activated. If a password is assigned, changes to the AMS 335i can only be made after the password is entered. The master password 2301 bridges the individually set password.	OFF
	Password entry		Configuration option of a four-digit numerical password	
Parameters to default			By pressing the enter button (↵) after selecting <i>Parameters to default</i> , all parameters are reset to their standard settings without any further security prompts. In this case, English is selected as the display language.	

Additional important information on parameter handling can be found at the end of the chapter.

### CANopen submenu

Table 8.2: CANopen submenu

Level 3	Level 4	Level 5	Selection/configuration option Description	Standard
Activation			ON / OFF	ON
Node ID			Value range 1 - 127	1
Baud rate			20 kbit/s / 50 kbit/s / 125 kbit/s / 250 kbit/s / 500 kbit/s / 800 kbit/s / 1000 kbit/s Selection of the baud rate for serial communication. The baud rate specifies the speed of data transmission. It must be the same at the transmission and reception sides to enable communication.	125 kbit/s
Position resolution			0.01 mm / 0.1 mm / 1 mm / 10 mm / free resolution The measurement value can be displayed in these resolutions. The value of the free resolution is determined in the "Position value" submenu in the "Value of free resolution" parameter.	1 mm
Velocity resolution			1 mm / 10 mm / 100 mm / 1000 mm / free resolution The current velocity can be displayed in these resolutions. The value of the free resolution is determined in the "Velocity value" submenu in the "Value of free resolution" parameter.	1 mm/s

### Position value submenu



**Notice!**

The parameters named under position value are to be set via the EDS file of the AMS 335i. If parameters from the position value submenu are changed via the display, these may be overwritten via a startup sequence stored in the control.

Table 8.3: Position value submenu

Level 3	Level 4	Level 5	Selection/configuration option Description	Standard
Measurement unit			Metric/Inch Specifies the units of the measured distances	Metric
Count direction			Positive/Negative Positive: The measurement value begins at 0 and increases with increasing distance. Negative: The measurement value begins at 0 and decreases with increasing distance. Negative distance values may need to be compensated with an offset or preset.	Positive
Offset			Output value=measurement value+offset. The resolution of the offset value is independent of the selected "Resolution position" and is entered in mm or inch/100. The offset value is effective immediately following entry. If the preset value is activated, this has priority over the offset. Preset and offset are not offset against each other.	0mm
Preset			The preset value is accepted by means of teach pulse. The teach pulse can be applied to a hardware input of the M12 PWR connector. The hardware input must be appropriately configured. See also configuration of the I/Os.	0mm
Free resolution value			The measurement value can be resolved in increments of 1/1000 within the 5 ... 50000 value range. If, e.g., a resolution of 0.875mm per digit is required, the parameter is set to 875. In the activated interface, the measurement value display must also be set to "free resolution" ("Resolution position" parameter).	1000
Error delay			ON / OFF Specifies whether, in the event of an error, the position value immediately outputs the value of the "Position value in the case of error" parameter or the last valid position value for the configured error delay time.	ON/100 ms
Position value in the case of error			Last valid value / zero Specifies which position value is output after the error delay time elapses.	Zero

**I/O submenu**

Table 8.4: I/O submenu

Level 3	Level 4	Level 5	Selection/configuration option Description	Standard
I/O 1	Port configuration		Input/Output Defines whether I/O 1 functions as an output or input.	Output
	Switching input	Function	No function/preset teach/laser ON/OFF	No function
		Activation	Low active/High active	Low active
	Switching output	Function	Pos. limit value 1 / Pos. limit value 2 / Velocity / Intensity (ATT) / Temp. (TMP) / Laser (LSR) / Plausibility (PLB) / Hardware (ERR) The individual functions are "ORed" on the selected switching output.	Plausibility (PLB), hardware (ERR)
		Activation	Low active/High active	Low active

Table 8.4: I/O submenu

Level 3	Level 4	Level 5	Selection/configuration option Description	Standard
I/O 2	Port configuration		Input/Output Defines whether I/O 2 functions as an output or input.	Output
	Switching input	Function	No function/preset teach/laser ON/OFF	No function
		Activation	Low active/High active	Low active
	Switching output	Function	Pos. limit value 1 / Pos. limit value 2 / Velocity / Intensity (ATT) / Temp. (TMP) / Laser (LSR) / Plausibility (PLB) / Hardware (ERR) The individual functions are "ORed" on the selected switching output.	Intensity (ATT), Temp. (TMP), Laser (LSR)
		Activation	Low active/High active	Low active
Limit values	Upper pos. limit 1	Activation	ON / OFF	OFF
		Limit value input	Value input in mm or inch/100	0
	Lower pos. limit 1	Activation	ON / OFF	OFF
		Limit value input	Value input in mm or inch/100	0
	Upper pos. limit 2	Activation	ON / OFF	OFF
		Limit value input	Value input in mm or inch/100	0
	Lower pos. limit 2	Activation	ON / OFF	OFF
		Limit value input	Value input in mm or inch/100	0

**Other submenu**

Table 8.5: Other submenu

Level 3	Level 4	Level 5	Selection/configuration option Description	Standard
Heating control			Standard (10°C ... 15°C)/Extended (30°C ... 35°) Defines a switch-on/switch-off range for the heating control. The extended switch-on/switch-off range for heating may provide relief in the event of condensation problems. There is no guarantee that no condensation will occur on the optics in the extended switch-on/switch-off range due to the limited heating capacity. This parameter is available as standard, but functions only for devices with integrated heating (AMS 335... H).	Standard
Display illumination			10 minutes/ON Display illumination is switched off after 10 minutes or, if the parameter is set to "ON", illumination is always on.	10 min.
Display contrast			Weak/Medium/Strong The display contrast may change at extreme temperature values. The contrast can subsequently be adapted using the three levels.	Medium
Service RS232	Baud rate		57.6kbit/s / 115.2kbit/s The service interface is only available to Leuze internally.	115.2kbit/s

Table 8.5: Other submenu

Level 3	Level 4	Level 5	Selection/configuration option Description	Standard
	Format		8,e,1 / 8,n,1 The service interface is only available to Leuze internally.	8,n,1

### 8.3.3 Language selection menu

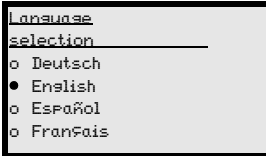

There are 5 display languages available:

- German
- English
- Spanish
- French
- Italian

The AMS 335*i* is delivered from the factory with the display preset to English.



**Notice!**

*When operating the AMS 335*i* on the CANopen, the language configured in the EDS file is used in the display.*

To change the language, no password needs to be entered nor must password enabling be activated. The display language is a passive operational control and is, thus, not a function parameter, per se.

### 8.3.4 Service menu

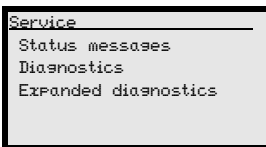

A more detailed description of the individual functions can be found in chapter 10.

## 8.4 Operation



Described here is an operating process using parameter enabling as an example.

### Parameter enabling

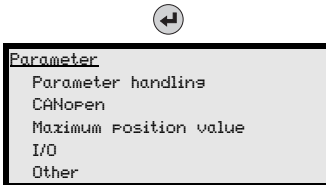
During normal operation parameters can only be viewed. If parameters are to be changed, the ON menu item in the Parameter → Parameter handling → Parameter enable menu must be activated. To do this, proceed as follows:



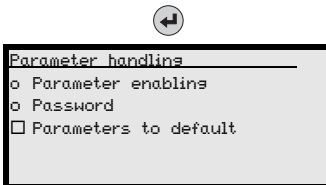

In the main menu, press the enter button to enter the Parameter menu.

Use the   buttons to select the Parameter handling menu item.



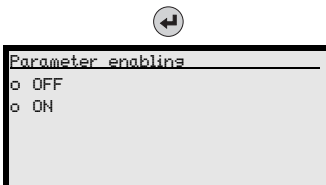

Press the enter button to enter the Parameter handling menu.

In the Parameter handling menu, use the   buttons to select the Parameter enabling menu item.



Press the enter button to enter the Parameter enabling menu.

In the Parameter enabling menu, use the   buttons to select the ON menu item.



Press the enter button to switch on parameter enabling.

The PWR LED illuminates orange; the display is inverted. You can now set the individual parameters on the display.

Press the ESC button twice to return to the Parameter menu.



### Viewing and editing parameters



As long as parameter enabling is activated, the entire AMS 335i display is inverted.

As long as parameter enabling is activated, communication between control and AMS 335i is interrupted. The continued networking via BUS OUT is retained.

**Notice!**

If a password was stored, parameter enabling is not possible until this password is entered, see "Password for parameter enabling" below.

**Password for parameter enabling**

Parameter entry on the AMS 335*i* can be protected with a password. With the AMS 335*i*, the password is defined via the EDS file (class 100, instance 1). Thus, the password cannot be changed by means of display entry.

To activate parameter enabling via the display (e.g., for changing an address), the password defined in the EDS file must be entered. If parameter enabling has been activated after successfully entering the password, parameters can temporarily be changed via the display.

After deactivating the parameter enable, all changes made to the display are overwritten by the start-up sequence that may be stored in the control (see above). If a new password has been assigned, this, too, is overwritten by the password defined in the EDS file.

**Notice!**

The **master password 2301** can enable the AMS 335*i* at any time.

## 9 CANopen interface

### 9.1 General information on CANopen

#### 9.1.1 Topology

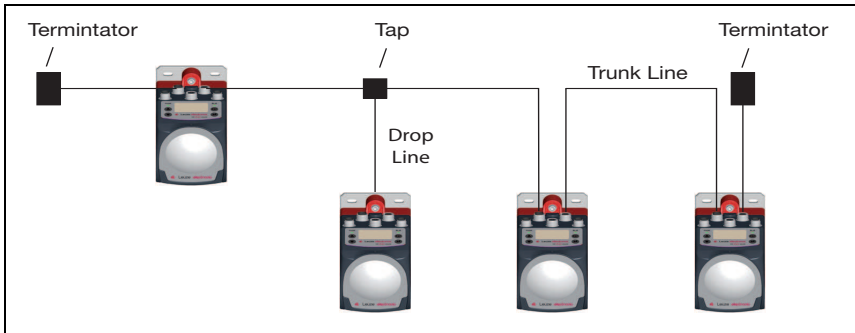

Figure 9.1: Bus topology

The CAN bus is a serial 2-wire bus system to which all participants are connected in parallel (i.e., using short drop lines). To avoid reflections, the bus must be terminated with a terminating resistor of 120ohm at each end of the trunk line. Terminating resistors are also required for very short trunk line cable lengths.

If the AMS 335*i* is the last participant in the trunk line, the trunk line can be terminated via the M12 bus OUT connection. For this purpose, Leuze electronic offers an M12 terminating resistor, see chapter 11 "Type overview and accessories".

#### 9.1.2 Bus line (trunk line)

For CAN, the maximum cable length of the trunk line is predominantly limited by the signal propagation time. The multi-master bus-access process (arbitration) requires that the signals are present virtually simultaneously at all nodes/participants. Therefore, the cable length of the trunk cable must be adapted to the baud rate.

Baud rate	Bus length
1 Mbit/s	< 20m
800kbit/s	< 50m
500kbit/s	< 100m
250kbit/s	< 250m
125kbit/s	< 500m
50kbit/s	< 1000m
20kbit/s	< 2500m

### 9.1.3 Stub lines (drop lines)

If possible, drop lines should be avoided because they cause signal reflections as a matter of principle. Generally, the reflections caused by drop lines are not critical, however, if the following drop line lengths are not exceeded.

Baud rate	Length of drop line	Total length of all drop lines
1 Mbit/s	< 1 m	< 5 m
800 kbit/s	< 1 m	< 25 m
500 kbit/s	< 1 m	< 25 m
250 kbit/s	< 10 m	< 50 m
125 kbit/s	< 20 m	< 100 m
50 kbit/s	< 50 m	< 250 m
20 kbit/s	< 50 m	< 250 m



**Attention!**

Drop lines must not be fitted with terminating resistors. If the AMS 335*i* is integrated into a drop line, the M12 bus OUT connection must not be terminated.

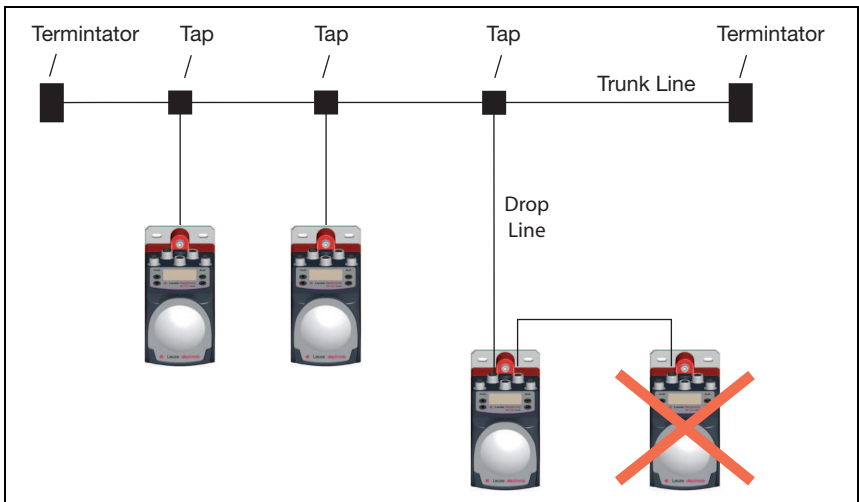

Figure 9.1: Prohibited networking within a drop line



**Attention!**

AMS 335*i* should not be networked with each other within a drop line. The max. permissible cable length of a drop line must not be exceeded. Taps and multi-taps permit a wide range of topologies.



## 9.2 Address assignment



### **Notice!**

*The participant-specific address for CANopen is also called the Node ID. Throughout this handbook, the term "address" is used, which is identical to "Node ID".*

Each participant connected to CANopen is assigned its own address (Node ID).

Up to 127 participants can be connected to one network. The addresses range from 1 to 127. The address 0 is usually reserved for the CANopen master.









### **Notice!**

*The "Layer Setting Services (LSS)" function is not supported by the AMS 335*i*. For this reason, the address must be set manually via the display/panel of the AMS.*

### 9.2.1 Entering the address via the display

To enter the address via the display, proceed as follows:

-  *Activate parameter enabling.*
-  *Select the CANopen submenu.*
-  *Select the Node ID menu item.*
-  *Enter an address between 1 and 127.*
-  *Save the address with Save.*
-  *Deactivate parameter enabling.*



### **Notice!**

*Basic operation of the display is described in chapter 8. To set the address, parameter enabling must be activated.*



### **Attention!**

*The laser measurement system is deactivated on the CANopen when parameter enabling is activated, e.g. for address assignment.*

If the AMS 335*i* is connected directly in the trunk line and networked with further participants via Bus Out, these participants remain active even after the parameter enable has been activated.

The AMS 335*i* is reactivated on CANopen after parameter enabling is exited.

### 9.3 Baud rate setting

The AMS 335*i* supports the following baud rates:

- 1 Mbit/s
- 800kbit/s
- 500kbit/s
- 250kbit/s
- **125 kbit/s**
- 50kbit/s
- 20kbit/s

The default setting of the AMS 335*i* is 125kbit/s.

The "Layer Setting Services (LSS)" function is not supported by the AMS 335*i*. The baud rate must be set manually via the display of the AMS.

#### 9.3.1 Entering the baud rate via the display/panel

To enter the baud rate via display/panel, proceed as follows:

- ↳ Activate parameter enabling.
- ↳ Select the CANopen submenu.
- ↳ Select the baud rate menu item.
- ↳ Activate the desired baud rate.
- ↳ Deactivate parameter enabling.



#### **Notice!**

Basic operation of the display is described in chapter 8. To set the baud rate, parameter enabling must be activated.



#### **Attention!**

The laser measurement system is deactivated on the CANopen when parameter enabling is activated, e.g. for baud rate setting.

If the AMS 335*i* is connected directly in the trunk line and networked with further participants via Bus Out, these participants remain active even after parameter enable has been activated. The AMS 335*i* is reactivated on CANopen after parameter enabling is exited.

## 9.4 CANopen electrical connection

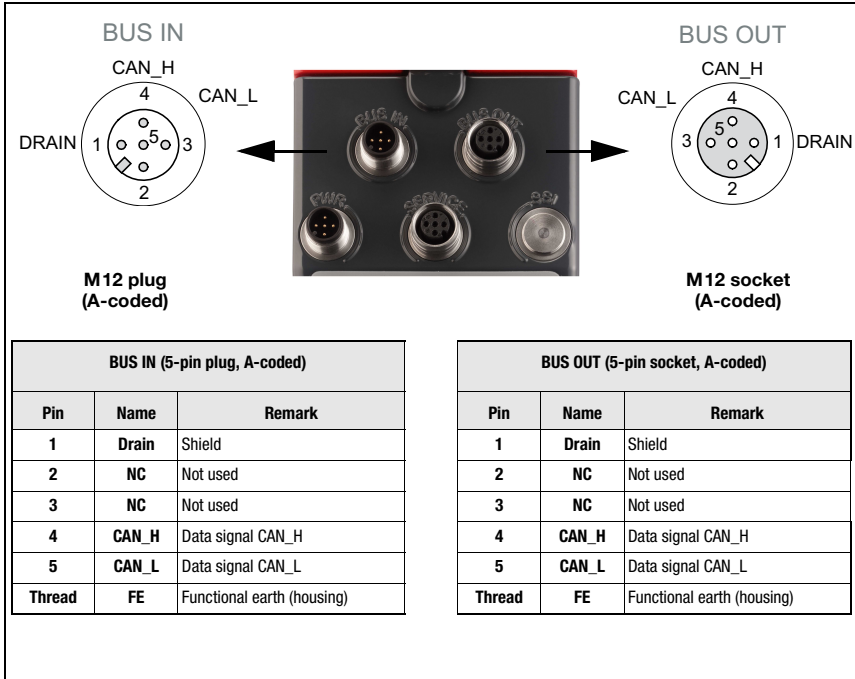

Figure 9.1: CANopen - electrical connection

If the laser measurement system is the last subscriber in the network, the **BUS OUT** connection must be connected to a terminator plug, see "Accessory terminating resistor" on page 94..



**Notice!**

For contacting **BUS IN** and **BUS OUT**, we recommend our ready-made CANopen cable (see chapter 11.3.6 "Accessory ready-made cables for CANopen").

## 9.5 Communication mechanisms of the AMS 335*i* on CAN

In a CANopen network, all participants have in principle equal privileges. Each participant can initiate its data transmission independently. Here, the arbitration specified by the CIA controls the access of the individual participants to the network. Generally, each CAN participant listens in on the bus. The transmission process is started only if the bus is not occupied by another CAN participant. When transmitting, the current bus status is always compared to the own transmitted frame.

If several participants start a transmission simultaneously, the arbitration process decides which participant gains access to the network next. The individual participants are integrated into a prioritization scheme via their bus address and the type of data to be transmitted (index address of the data). Process data (PDOs) of a device are transmitted with a higher priority than, for example, variable objects (SDOs) of a device.

The node address of the participant is another criterion for prioritizing a participant in the network. The smaller the node address, the higher the priority of the participant in the network.

Since every participant compares its own priority with that of the other participants at the time of bus access, the participants with low priority discontinue their transmission activities immediately. The participant with the highest priority obtains temporary access to the bus. The arbitration process controls the access of all participants so that even participants with a low priority have access to the bus.

### 9.5.1 Device profile of the AMS 335*i*

CANopen describes the characteristics of participants in so-called profiles. The AMS 335*i* communicates according to the specifications in profile "DS406" class 1.

The profile defines the accesses to an absolute linear encoder.

The AMS 335*i* is designed as a slave participant and cannot take on master functionality.

### 9.5.2 Object directories

All process data and parameters are stored as objects in the AMS 335*i*. The object directory of the AMS 335*i* is the compilation of all process data and parameters of the AMS.

An object directory is structured such that some objects within a device profile (DS406 for the AMS 335*i*) are mandatory while others are freely definable and stored in the manufacturer-specific object area.

The objects are uniquely identified using an index addressing scheme. The structure of the object directory, the assignment of the index numbers, as well as some mandatory entries are specified in the CIA standard DS301 for CANopen.

### 9.5.3 EDS file

For the user, the object directory of the AMS 335*i* is stored as an EDS file (Electronic Data Sheet).

The EDS file contains all objects with index, sub-index, name, data type, default value, minimum and maximum, and access privileges.

The EDS file describes the entire functionality of the AMS 335*i*.

### 9.5.4 SDOs and PDOs

The data exchange in CANopen distinguishes between service data objects (SDOs), which are used for transmitting the service data (parameters) from and to the object directory, and process data objects (PDOs), which are used to exchange the current process states.

#### 9.5.4.1 SDOs

By using SDOs, all entries of the object directory can be accessed. Within one SDO call, only one object can be accessed at any one time. For this reason, a service data telegram must have a protocol structure which describes the exact target address by means of index and sub-index addressing. SDO telegrams place a part of the SDO addressing into the user data area. Eventually, a user data area with a width of 4 bytes out of the possible 8 bytes of user data remains for each SDO telegram.

The target address always responds to SDO transfers.

In the following, the index and sub-index address of the AMS 335*i* parameters and variables can be found in the individual object descriptions.

#### 9.5.4.2 PDOs

PDOs are a grouping of objects (variables and parameters) from the object directory. A maximum of 8 bytes of user data from various objects can be mapped into one PDO.

A PDO can be received and evaluated by each participant (node). The model is referred to as the producer-consumer procedure.

Since there is no protocol structure in the telegram of a PDO, the participants in the network for whom these data are intended must know how the user data in the data area of the PDO are structured (which data are stored where in the user data area).

The exchange of process data is supported by the AMS 335*i* via the following accesses:

- **Event-controlled data transfer**  
Here, the data of a node are transmitted as a message whenever a change to the present state occurs.
- **Polling with remote frames**  
The CAN node which has been defined as master in the network requests the desired information via query (via remote frame). The participant which has this information (or the required data) responds by sending the requested data.
- **Synchronized mode**  
CANopen permits simultaneous querying of inputs and states of different participants and the simultaneous change of outputs or states. For this purpose, one uses the synchronization telegram (SYNC) transmitted by a master.  
The SYNC telegram is a broadcast to all network devices with high priority and without data content. Generally, the master sends the SYNC telegram cyclically.  
Participants working in synchronized mode read their data when receiving the SYNC message and then transmits them immediately afterwards as soon as the bus permits this (see explanation regarding arbitration process).  
As the SYNC process can very quickly lead to high bus loads, another distinction is made between "event-controlled synchronization" and a "timer synchronization".
- **Time-controlled transmission**  
In this case, the transmission of a PDO is triggered when an adjustable time period has elapsed. The time-controlled transmissions are set individually for each PDO via the so-called "inhibit time" or an "event timer". The respective parameters can be found in the objects 1800h to 1803h for the corresponding PDOs.
- **Node monitoring**  
Heartbeat and guarding mechanisms are available for failure monitoring of the AMS 335*i*. This is particularly important for CANopen, as the AMS 335*i* may not respond regularly in the event-controlled operating mode. In case of guarding, the participants are cyclically queried for their state via data request telegrams (remote frame). In case of heartbeat, the nodes transmit their state themselves.  
Heartbeat and guarding / life time are standard communication objects from the DS301 CANopen specification. The corresponding objects here are:
  - Heartbeat 1017<sub>h</sub>
  - Guarding / Life time factor 100C<sub>h</sub> and 100D<sub>h</sub>

### 9.5.5 Default 11 Bit - Identifier distribution

The AMS 335*i* sends an 11-bit identifier. 29-bit identifiers can neither be received nor transmitted by the AMS 335*i*.

The node address (address of the AMS 335*i*) is an integral part of the 11-bit identifier. The default identifier and the node address yield the COB-ID. Its value is used to determine the prioritization during arbitration.



#### **Notice!**

*Identifiers with low values have a higher priority under arbitration.*

#### **Example:**

If the same objects, e.g. PD01 (rx), are queried by several AMS 335*i* in a CANopen network, the AMS with the smallest node address has the highest priority under arbitration.

The table printed below shows the values of the individual functions in the CANopen arbitration process.

As can be seen from the table, synchronization and emergency objects have the highest priority. Next in line are the PDOs, and the SDOs have the lowest priority.

Identifier 11 Bit (binary)	Identifier dec.	Identifier hex.	Function
0000000000	0	0	Network management
0001000000	128	80	Synchronization
0001xxxxxx	129 - 255	81 - FF	Emergency
0011xxxxxx	385 - 511	181 - 1FF	PD01 (tx)
0100xxxxxx	513 - 639	201 - 27F	PD01 (rx)
0101xxxxxx	641 - 767	281 - 2FF	PD02 (tx)
0110xxxxxx	769 - 895	301 - 37F	PD02 (rx)
0111xxxxxx	897 - 1023	381 - 3FF	PD03 (tx)
1000xxxxxx	1025 - 1151	401 - 47F	PD03 (rx)
1001xxxxxx	1153 - 1279	481 - 4FF	PD04 (tx)
1010xxxxxx	1281 - 1407	501 - 57F	PD04 (rx)
1011xxxxxx	1409 - 1535	581 - 5FF	SDO transmit
1100xxxxxx	1537 - 1663	601 - 67F	SDO receive
1110xxxxxx	1793 - 1919	701 - 77F	NMT Error Control
xxxxxxx = node address 1 - 127			

### 9.5.6 The communication-specific objects according to DS301, DS406 and manufacturer-specific

**Overview: CANopen-specific object area of the AMS 335i**

The following overview table shows the CANopen-specific communication objects from DS301 supported by the AMS 335i. The manual describes only those objects for which AMS 335i-specific configurations can be made. All other objects are standard objects of the CANopen specification. These objects are described in DS301.

Object address in hex	CANopen-specific object area
1000	Device type
1001	Error register
100C	Guard time
100D	Life time factor
1017	Producer heartbeat time (required for heartbeat mechanism)
1018	Identity object (contains general information regarding the device)
1800	PDO 1 properties (asynchronous position value and state)
1801	PDO 2 properties (synchronous position value and state)
1802	PDO 3 properties (asynchronous velocity value and state)
1803	PDO 4 properties (synchronous velocity value and state)
1A00	TPDO 1 asynchronous position value and state
1A01	TPDO 2 synchronous position value and state
1A02	TPDO 3 asynchronous velocity value and state
1A03	TPDO 4 synchronous velocity value and state

**Overview: manufacturer-specific object area of the AMS 335i**

Object address in hex	AMS 335i-specific object area
2000	Maximum position value
2001	Static preset
2002	Dynamic preset
2010	Position limit value 1
2011	Position limit value 2
2020	Velocity
2021	Velocity limit value 1
2022	Velocity limit value 2
2023	Velocity limit value 3
2024	Velocity limit value 4
2025	Velocity limit value dynamic
2026	Velocity status
2050	I/O 1
2051	I/O 2
2060	Status and control laser ON/OFF
2070	Error handling procedures
2300	Other

**Overview: encoder-specific object area of the AMS 335i**

Object address in hex	Objects of the AMS 335i from the DS406 class 1 encoder profile
6000	Operating parameters
6004	Maximum position value
6500	Operating status
6501	Resolution measurement value



## 9.5.7 Detailed description of CANopen-specific object area

### 9.5.7.1 Object 1000<sub>h</sub> Device type

The object describes the AMS 335*i* device type.

Index (hex)	Sub-index (hex)	Name	Data type	Access	Value range			Remark
					Minimum	Maximum	Default	
1000	--	Device type	u32	ro	--	--	00080196 <sub>h</sub>	Device profile 196 <sub>h</sub> Encoder type 8 <sub>h</sub>

#### Object data structure

Byte	Bit								Remark
	7	6	5	4	3	2	1	0	
0	196 <sub>h</sub>								Device profile (196 <sub>h</sub> )
1									
2	8 <sub>h</sub>								Encoder type (8 <sub>h</sub> )
3									

#### Device profile

The 196<sub>h</sub> = 406<sub>d</sub> classification describes the profile of an encoder. Accordingly, the AMS 335*i* is integrated into the profile definition of an encoder.

**The AMS 335*i* is a class 1 encoder acc. to profile 406<sub>d</sub>**

#### Encoder

The 8<sub>h</sub> = 8<sub>d</sub> classification describes the AMS 335*i* as an absolute linear encoder

### 9.5.7.2 Object 1001<sub>h</sub> Error register

This object contains the error register for the AMS 335*i*. The AMS 335*i* maps the internal ERR error (see object 2060 status and control) in this byte to bit 0.

The bit 0 is set when the "ERR" errors of the AMS 335*i* are pending or if, for example, the initialization of the AMS 335*i* fails.

Index (hex)	Sub-index (hex)	Name	Data type	Access	Value range			Remark
					Minimum	Maximum	Default	
1001	--	Error register	u8	ro	--	--	0	--

#### Object data structure

Byte	Bit								Remark
	7	6	5	4	3	2	1	0	
0	x	x	x	x	x	x	x	0	Error register

### 9.5.7.3 Object 100C<sub>n</sub> Guard time

This object is used to configure the device monitoring by the NMT master (node guarding) together with the life time factor. The monitoring period is specified in milliseconds. If 0 is entered (default of the AMS 335*i*), the process is deactivated.

Index (hex)	Sub-index (hex)	Name	Data type	Access	Value range			Remark
					Minimum	Maximum	Default	
100C	--	Guard time	u16	rw	0	65535	0	Guard time is deactivated via Default 0

### 9.5.7.4 Object 100D<sub>n</sub> Life time factor

This object must be discussed in connection with object 100C<sub>n</sub>. It represents a value that yields the lifetime when multiplied by the guard time.

If 0 is entered (default of the AMS 335*i*), the process is deactivated.

Index (hex)	Sub-index (hex)	Name	Data type	Access	Value range			Remark
					Minimum	Maximum	Default	
100D	--	Life time	u 8	rw	0	255	0	Life time is deactivated via Default 0

### 9.5.7.5 Object 1017<sub>n</sub> Producer heartbeat time

This object defines the cycle time as a multiple of milliseconds with which the AMS 335*i* sends heartbeat messages into the CANopen network. If the producer heartbeat time is not used, it is set to the value 0 (zero). By default, the time for the AMS 335*i* is set to 0 (zero), which means that the AMS 335*i* does not send a cyclical heartbeat signal.

Index (hex)	Sub-index (hex)	Name	Data type	Access	Value range			Remark
					Minimum	Maximum	Default	
1017	--	Producer heartbeat time	u16	rw	0	65536	0	Producer heartbeat time is deactivated via Default 0

### 9.5.7.6 Object 1018<sub>n</sub> Identity object

This object contains general specifications about the AMS 335*i*.

Index (hex)	Sub-index (hex)	Name	Data type	Access	Value range			Remark
					Minimum	Maximum	Default	
1018	01	Vendor ID	u 32	ro	--	--	121 <sub>h</sub>	Manufacturer ID number
	02	Product code	u 32	ro	--	--	02 <sub>h</sub>	Product designation

### 9.5.7.7 Objects 1800<sub>h</sub> - 1803<sub>h</sub> Communication parameter process data objects (PDOs)

#### 9.5.7.8 Objects 1A00<sub>h</sub> - 1A03<sub>h</sub> Process data objects TPDOs

The AMS 335*i* provides four transmit process data objects (TPDOs).

The TPDOs describe which objects are mapped (integrated) into the TxPDO and define the access (synchronous/asynchronous) to these objects.

- TPDO1 asynchronous position value and state, object address 1A00<sub>h</sub>
- TPDO2 synchronous position value and state, object address 1A01<sub>h</sub>
- TPDO3 asynchronous velocity value and state, object address 1A02<sub>h</sub>
- TPDO4 synchronous velocity value and state, object address 1A03<sub>h</sub>

The communication parameters of the PDOs are defined via fixed objects.

In these objects one specifies the synchronous or asynchronous access, a possible inhibit time for the PDO object on the CAN network, and an event timer.

- PDO1 communication parameters for asynchronous position value and state, object address 1800<sub>h</sub>
- PDO2 communication parameters for synchronous position value and state, object address 1801<sub>h</sub>
- PDO3 communication parameters for asynchronous velocity value and state, object address 1802<sub>h</sub>
- PDO4 communication parameters for synchronous velocity value and state, object address 1803<sub>h</sub>

The **asynchronous transmission** (TPDO1 and TPDO3) is controlled by the event timer in PDOx property objects 1800<sub>h</sub> and 1803<sub>h</sub>.

The **synchronous transmission** (TPDO2 and TPDO4) is initiated via a SYNC telegram (80<sub>h</sub>) sent by the master, and via PDOx property objects 1801<sub>h</sub> to 1803<sub>h</sub>.

#### 9.5.7.9 Object 1800<sub>h</sub> PDO1

Communication parameters for asynchronous transmission of position and state.

Index (hex)	Sub-index (hex)	Name	Data type	Access	Value range			Remark
					Minimum	Maximum	Default	
1800	01	COB-ID for TPDO1	u 32	ro	--	--		180h + Node ID
	02	Transmission type	u 8	rw	--	--	254	254 = asynchronous
	03	Inhibit time	u 16	rw	0	1000	0	Inhibit time
	04	Reserved						
	05	Event timer	u 16	rw	0	65535	0	Event timer



#### Attention!

The inhibit timer can only be written to if the PDO has previously been set to "PDO invalid". This is done by setting bit 31 of the COB-ID for the respective PDO to 1, setting the inhibit time to the desired value, and then resetting bit 31 to 0 (=PDO valid). This applies to all 4 PDOs!

**9.5.7.10 Object 1A00<sub>h</sub> TPDO1**

Asynchronous transmission of position and state.

Index (hex)	Sub-index (hex)	Name	Data type	Access	Value range			Remark
					Minimum	Maximum	Default	
1A00	01	Maximum position value	u 32	ro	--	--	6004 00 20	Position value from object 6004
	02	Position value status	u 32	ro	--	--	2060 01 20	Status from object 2060

**Data structure TPDO1 for the asynchronous transmission of the position values and the position state**

Byte	Bit								Remark
	7	6	5	4	3	2	1	0	
0								LSB	Position values see object description 6004 <sub>h</sub>
1									
2									
3	MSB								
4									Status see object description 2060 <sub>h</sub> sub-index 01
5									
6									
7									

**9.5.7.11 Object 1801<sub>h</sub> PDO2**

Communication parameters for synchronous transmission of position and state.

Index (hex)	Sub-index (hex)	Name	Data type	Access	Value range			Remark
					Minimum	Maximum	Default	
1801	01	COB-ID for TPDO1	u 32	ro	--	--		280h + Node ID
	02	Transmission type	u 8	rw	--	--	1	1 = cyclical + synchronous
	03	Inhibit time	u 16	rw	0	1000	0	Inhibit time
	04	Reserved						
	05	Event timer	u 16	rw	0	65535	0	Event timer

**9.5.7.12 Object 1A01<sub>h</sub> TPDO2**

Synchronous transmission of position and state.

Index (hex)	Sub-index (hex)	Name	Data type	Access	Value range			Remark
					Minimum	Maximum	Default	
1A01	01	Maximum position value	u 32	ro	--	--	6004 00 20	Position value from object 6004
	02	Position value status	u 32	ro	--	--	2060 01 20	Status from object 2060

**Data structure TPDO2 for the synchronous transmission of the position value and the position state**

Byte	Bit								Remark	
	7	6	5	4	3	2	1	0		
0									LSB	Position data see object description 6004 <sub>h</sub>
1										
2										
3	MSB									
4										Status see object description 2060 <sub>h</sub> sub-index 01
5										
6										
7										

**9.5.7.13 Object 1802<sub>h</sub> PDO3**

Communication parameters for asynchronous transmission of velocity and state.

Index (hex)	Sub-index (hex)	Name	Data type	Access	Value range			Remark
					Minimum	Maximum	Default	
1803	01	COB-ID for TPDO1	u 32	ro	--	--		380h + Node ID
	02	Transmission type	u 8	rw	--	--	254	254 = asynchronous
	03	Inhibit time	u 16	rw	0	1000	0	Inhibit time
	04	Reserved						
	05	Event timer	u 16	rw	0	1000	0	Event timer

**9.5.7.14 Object 1A02<sub>h</sub>**

TPDO3 Asynchronous transmission of velocity and state.

Index (hex)	Sub-index (hex)	Name	Data type	Access	Value range			Remark
					Minimum	Maximum	Default	
1A02	01	Velocity value	int 32	ro	--	--	2020 04 20	velocity value from object 2020 sub-index 04
	02	Status velocity value	u 16	ro	--	--	2026 00 10	Status from object 2026

**Data structure TPDO3 for the asynchronous transmission of the velocity values and the velocity state**

Byte	Bit								Remark	
	7	6	5	4	3	2	1	0		
0									LSB	Velocity value see object description 2020 <sub>h</sub> sub-index 04
1	MSB									
2										Status see object description 2026 <sub>h</sub> sub-index 01
3										

**9.5.7.15 Object 1803<sub>n</sub>, PDO4**

Communication parameters for synchronous transmission of velocity and state.

Index (hex)	Sub-index (hex)	Name	Data type	Access	Value range			Remark
					Minimum	Maximum	Default	
1804	01	COB-ID for TPDO1	u 32	ro	--	--		480h + Node ID
	02	Transmission type	u 8	rw	--	--	1	1 = synchronous + cyclical
	03	Inhibit time	u 16	rw	0	1000	0	Inhibit time
	04	Reserved						
	05	Event timer	u 16	rw	0	65535	0	Event timer

**9.5.7.16 Object 1A03<sub>n</sub>**

TPDO3 Synchronous transmission of velocity and state.

Index (hex)	Sub-index (hex)	Name	Data type	Access	Value range			Remark
					Minimum	Maximum	Default	
1A03	01	Velocity value	int 16	ro	--	--	2020 04 20	velocity value from object 2020 sub-index 04
	02	Status velocity value	u 16	ro	--	--	2026 00 10	Status from object 2026

**Data structure TPDO4 for the synchronous transmission of the velocity value and the velocity state**

Byte	Bit								Remark
	7	6	5	4	3	2	1	0	
0								LSB	Velocity value see object description 2020 <sub>n</sub> sub-index 04
1	MSB								
2									Status see object description 2026 <sub>n</sub> sub-index 01
3									

**9.5.8 AMS 335<sub>i</sub>-specific object area**

**9.5.8.1 Object 2000<sub>n</sub>, Position value**

The object position value describes the following entries:

- Sign for negative position values
- Unit of the position value: metric or inch
- Resolution of the position value
- Counting direction of the position value
- A possible offset value
- Value for the free resolution

Index (hex)	Sub-index (hex)	Name	Data type	Access	Value range			Remark
					Minimum	Maximum	Default	
2000	01	Sign	u 8	rw	0	1	0	0 = two's complement 1 = sign + quantity
	02	Measurement unit	u 8	rw	0	1	0	0 = metric 1 = inch (in)
	03	Resolution	u 8	rw	0	6	4	Value 1 = 0.001 Value 2 = 0.01 Value 3 = 0.1 Value 4 = 1 Value 5 = 10 Value 6 = free resolution
	04	Count direction	u 8	rw	0	1	0	0 = positive 1 = negative  for further remarks, see below
	05	Offset value	int 32	rw	-999999	999999	0	see remarks below
	06	Free resolution value	u 16	rw	5	50000	1000	see remarks below

### Sub-index 03 resolution

The resolution in mm or inch/100, in accordance with the unit selected.  
The value for the free resolution must be set in index 06.

### Sub-index 04 counting direction



#### Attention!

The DS406 encoder specification prescribes that the counting direction can be set in object 6000 bit 3. Object 2000 sub-index 04 and object 6000 bit 3 overwrite each other.

The count direction changes the sign during velocity measurement.

A suitable offset is to be selected so that only positive values are transferred.

#### Counting direction positive:

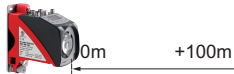

#### Counting direction negative:



### Sub-index 05 offset value

The offset value in mm or inch/100, in accordance with the unit selected.

Output value = measurement value + offset.

If the preset value has been activated by a corresponding trigger signal, the preset value has priority over the offset value.

Preset value and offset value are not offset against each other. The resolution of the offset value is independent of the position value resolution selected. The offset value is active immediately without any further release.

**Sub-index 06 free resolution**

Free resolution in mm/1000 or inch/100000, in accordance with the unit selected.

The "free resolution" parameters from sub-index 03 and the "value free resolution" from sub-index 06 are mutually dependent. The value of the free resolution is multiplied by mm/1000 or inch/100000 in accordance with the unit selected. The multiplication product is then the free resolution that has been set.

**9.5.8.2 Object 2001<sub>n</sub> Static preset value**

The static preset value is a parameter that is not changed after the handover of the system to the end user. It is configured during commissioning and remains unchanged thereafter. A preset value can be entered into the object. The preset value is activated with "preset teach" and deactivated with "preset reset". After preset teach, the current position value is offset against the configured preset value. After preset reset, the original measurement value is displayed.

Index (hex)	Sub-index (hex)	Name	Data type	Access	Value range			Remark
					Minimum	Maximum	Default	
2001	01	Preset value static	int 32	rw	-999999	999999	0	Preset value, in mm or in/100 depending on the unit selected
	02	Preset settings	u 8	rw	0	2	0	Value 1 = preset teach Value 2 = preset reset

**9.5.8.3 Object 2002<sub>n</sub> Dynamic preset value**

The dynamic preset value can be adapted permanently via the control.

The dynamic preset value is activated with "preset teach" and deactivated with "preset reset". After preset teach, the current position value is offset against the configured preset value. After preset reset, the original measurement value is displayed.

Index (hex)	Sub-index (hex)	Name	Data type	Access	Value range			Remark
					Minimum	Maximum	Default	
2002	01	Preset value static	int 32	rw	-999999	999999	0	Preset value, in mm or in/100 depending on the unit selected
	02	Preset settings	u 8	rw	0	2	0	Value 1 = preset teach Value 2 = preset reset



### 9.5.8.4 Object 2010<sub>h</sub> Position limit value range 1

The position limit value range 1 object defines a distance range with lower and upper limits. If the measured value lies outside the configured range, the corresponding status bits are set in objects 2050<sub>h</sub>, 2051<sub>h</sub> and 2060<sub>h</sub>.

Index (hex)	Sub-index (hex)	Name	Data type	Access	Value range			Remark
					Minimum	Maximum	Default	
2010	01	Enable position limit value 1	u8	rw	0	1	0	0 = deactivated 1 = activated
	02	Lower position limit value 1	int 32	rw	-999999	999999	0	see remarks below
	03	Upper position limit value 1	int 32	rw	-999999	999999	0	see remarks below

#### Sub-index 02<sub>h</sub> / Sub-index 03<sub>h</sub>

The lower and upper position limit values are entered in mm or inch/100 according to the unit selected.

### 9.5.8.5 Object 2011<sub>h</sub> Position limit value range 2

The position limit value range 2 object defines a distance range with lower and upper limits. If the measured value lies outside the configured range, the corresponding status bits are set in objects 2050<sub>h</sub>, 2051<sub>h</sub> and 2060<sub>h</sub>.

Index (hex)	Sub-index (hex)	Name	Data type	Access	Value range			Remark
					Minimum	Maximum	Default	
2011	01	Enable position limit value 2	u8	rw	0	1	0	0 = deactivated 1 = activated
	02	Lower position limit value 2	int 32	rw	-999999	999999	0	see remarks below
	03	Upper position limit value 2	int 32	rw	-999999	999999	0	see remarks below

#### Sub-index 02<sub>h</sub> / Sub-index 03<sub>h</sub>

The lower and upper position limit values are entered in mm or inch/100 according to the unit selected.

### 9.5.8.6 Object 2020<sub>h</sub> Velocity

Outputs the current velocity with the configured resolution. The unit (metric or inch) is set in object 2000 sub-index 02 and also applies to the velocity. If no change is made in object 2000 sub-index 02, the AMS 335*i* uses the metric default setting.

The sign of the velocity is dependent on the count direction in object 2000 sub-index 04.

In the default setting a positive velocity is output when the reflector moves away from the AMS 335*i*. When the reflector moves towards the AMS 335*i*, negative velocities are output.

If the "negative" count direction is configured in object 2000 sub-index 04, the velocity signs are reversed.

The integration time for the velocity averages all velocity values calculated during the selected period to yield a velocity value. This average velocity value is output via the interface.

Index (hex)	Sub-index (hex)	Name	Data type	Access	Value range			Remark
					Minimum	Maximum	Default	
2020	01	Velocity resolution	u8	rw	1	5	1	Value 1: = 1 Value 2: = 10 Value 3: = 100 Value 4: = 1000 Value 5 = free resolution
	02	Integration time velocity	u8	rw	0	6	3	Unit ms Value 0: = 2 Value 1: = 4 Value 2: = 8 Value 3: = 16 Value 4: = 32 Value 5: = 64 Value 6: = 128
	03	Free resolution velocity	u16	rw	5	50000	1000	The configured value is multiplied by mm/1000/s or in/100000/s.
	04	Velocity value	int 32	ro	-999999	999999	--	see below

The velocity value is mapped into process data objects 1A02<sub>h</sub> and 1A03<sub>h</sub>.

**Sub-index 01<sub>h</sub>**

The current velocity output occurs with the configured resolution. The unit (metric or inch) is set in object 2000 sub-index 02 and also applies to the velocity.

### 9.5.8.7 Object 2021<sub>h</sub> Configuration velocity monitoring 1

Objects 2021<sub>h</sub> to 2024<sub>h</sub> permit the comparison between the current velocity as measured by the AMS 335*i* and a limit stored in the respective object.



#### Notice!

#### Notice regarding velocity monitoring 1 - 4 and dynamic velocity monitoring

If **position start** and **position end** are identical, velocity monitoring is not activated.

If a direction-dependent limit value check is activated via the **direction selection** parameter, the values of **position start** and **position end** also define the direction. The check is always performed from **position start** to **position end**. For example, if the range start is "5500" and the range end is "5000", the direction-dependent check is only performed in the direction from "5500" to "5000". The limit value is not active in the opposite direction.

If the check is independent of direction, the order of **position start** and **position end** is irrelevant. Depending on the selected **switching mode**, if the value is above or below the defined limits, the limit value status in object 2026<sub>h</sub> is set and, if configured, the switching output is set via object 2050<sub>h</sub> or 2051<sub>h</sub>.



#### Notice!

The explanations given above on the "Position start" and "Position end" parameters apply analogously for objects 2022<sub>h</sub> through 2025<sub>h</sub>.

Index (hex)	Sub-index (hex)	Name	Data type	Access	Value range			Remark
					Minimum	Maximum	Default	
2021	01	Limit value check	u8	rw	0	7	0	see below
	02	Velocity limit value 1	u16	rw	0	20000	0	mm/s or (in/100)/s
	03	Hysteresis of velocity limit value 1	u16	rw	0	20000	100	mm/s or (in/100)/s
	04	Monitoring from position start	int 32	rw	-999999	999999	0	mm or in/100
	05	Monitoring to position end	int 32	rw	-999999	999999	0	mm or in/100

**Sub-index 01**

**Bit 0: switching mode**

- 0 = upon exceeding the velocity
- 1 = upon falling below the velocity limit

**Bit 1: direction selection**

- 0 = direction independent velocity monitoring
- 1 = direction dependent velocity monitoring

**Bit 2: velocity monitoring**

- 0 = deactivated
- 1 = activated

**Bit 3 - Bit 7: reserve**

**9.5.8.8 Object 2022<sub>n</sub> Configuration velocity monitoring 2**



**Notice!**

Further explanations on the "Position start" and "Position end" parameters see chapter 9.5.8.7 "Object 2021h Configuration velocity monitoring 1".

Index (hex)	Sub-index (hex)	Name	Data type	Access	Value range			Remark
					Minimum	Maximum	Default	
2022	01	Limit value check	u 8	rw	0	7	0	see below
	02	Velocity limit value 1	u 16	rw	0	20000	0	mm/s or (in/100)/s
	03	Hysteresis of velocity limit value 1	u 16	rw	0	20000	100	mm/s or (in/100)/s
	04	Monitoring from position start	i 32	rw	-999999	999999	0	mm or in/100
	05	Monitoring to position end	i 32	rw	-999999	999999	0	mm or in/100

**Sub-index 01**

**Bit 0: switching mode**

- 0 = upon exceeding the velocity
- 1 = upon falling below the velocity limit

**Bit 1: direction selection**

- 0 = direction independent velocity monitoring
- 1 = direction dependent velocity monitoring

**Bit 2: velocity monitoring**

0 = deactivated

1 = activated

**Bit 3 - Bit 7: reserve****9.5.8.9 Object 2023<sub>h</sub> Configuration velocity monitoring 3****Notice!**

Further explanations on the "Position start" and "Position end" parameters see chapter 9.5.8.7 "Object 2021<sub>h</sub> Configuration velocity monitoring 1".

Index (hex)	Sub- index (hex)	Name	Data type	Access	Value range			Remark
					Minimum	Maximum	Default	
2023	01	Limit value check	u 8	rw	0	7	0	see below
	02	Velocity limit value 1	u 16	rw	0	20000	0	mm/s or (in/100)/s
	03	Hysteresis of velocity limit value 1	u 16	rw	0	20000	100	mm/s or (in/100)/s.
	04	Monitoring from position start	int 32	rw	-999999	999999	0	mm or in/100
	05	Monitoring to position end	int 32	rw	-999999	999999	0	mm or in/100

**Sub-index 01****Bit 0: switching mode**

0 = upon exceeding the velocity

1 = upon falling below the velocity limit

**Bit 1: direction selection**

0 = direction independent velocity monitoring

1 = direction dependent velocity monitoring

**Bit 2: velocity monitoring**

0 = deactivated

1 = activated

**Bit 3 - Bit 7: reserve**

9.5.8.10 Object 2024<sub>n</sub> Configuration velocity monitoring 4



**Notice!**

Further explanations on the "Position start" and "Position end" parameters see chapter 9.5.8.7 "Object 2021h Configuration velocity monitoring 1".

Index (hex)	Sub-index (hex)	Name	Data type	Access	Value range			Remark
					Minimum	Maximum	Default	
2024	01	Limit value check	u 8	rw	0	7	0	see below
	02	Velocity limit value 1	u 16	rw	0	20000	0	mm/s or (in/100)/s
	03	Hysteresis of velocity limit value 1	u 16	rw	0	20000	100	mm/s or (in/100)/s.
	04	Monitoring from position start	int 32	rw	-999999	999999	0	mm or in/100
	05	Monitoring to position end	int 32	rw	-999999	999999	0	mm or in/100

**Sub-index 01**

**Bit 0: switching mode**

- 0 = upon exceeding the velocity
- 1 = upon falling below the velocity limit

**Bit 1: direction selection**

- 0 = direction independent velocity monitoring
- 1 = direction dependent velocity monitoring

**Bit 2: velocity monitoring**

- 0 = deactivated
- 1 = activated

**Bit 3 - Bit 7: reserve**

9.5.8.11 Object 2025<sub>h</sub> Configuration dynamic velocity monitoring**Notice!**

Further explanations on the "Position start" and "Position end" parameters see chapter 9.5.8.7 "Object 2021<sub>h</sub> Configuration velocity monitoring 1".

Index (hex)	Sub-index (hex)	Name	Data type	Access	Value range			Remark
					Minimum	Maximum	Default	
2025	01	Limit value check	u 8	rw	0	7	0	see below
	02	Velocity limit value 1	u 16	rw	0	20000	0	mm/s or (in/100)/s
	03	Hysteresis of velocity limit value 1	u 16	rw	0	20000	100	mm/s or (in/100)/s.
	04	Monitoring from position start	int 32	rw	-999999	999999	0	mm or in/100
	05	Monitoring to position end	int 32	rw	-999999	999999	0	mm or in/100

**Sub-index 01****Bit 0: switching mode**

- 0 = upon exceeding the velocity
- 1 = upon falling below the velocity limit

**Bit 1: direction selection**

- 0 = direction independent velocity monitoring
- 1 = direction dependent velocity monitoring

**Bit 2: velocity monitoring**

- 0 = deactivated
- 1 = activated

**Bit 3 - Bit 7: reserve**9.5.8.12 Object 2026<sub>h</sub> Velocity status

Index (hex)	Sub-index (hex)	Name	Data type	Access	Value range			Remark
					Minimum	Maximum	Default	
2026	--	Velocity status	u 16	ro	--	--	--	see below

**Bit 0: velocity measurement error**

- 0 = ok
- 1 = error

**Bit 1: movement status**

- 0 = no movement
- 1 = movement

**Bit 2: movement status**

- 0 = positive direction
- 1 = negative direction

**Bit 3: velocity limit value status 1**

- 0 = limit value maintained
- 1 = limit value violated

**Bit 4: velocity limit value status 2**

- 0 = limit value maintained
- 1 = limit value violated

**Bit 5: velocity limit value status 3**

- 0 = limit value maintained
- 1 = limit value violated

**Bit 6: velocity limit value status 4**

- 0 = limit value maintained
- 1 = limit value violated

**Bit 7: velocity limit value status dynamic**

- 0 = limit value maintained
- 1 = limit value violated

**Bit 8: velocity comparison limit value 1**

- 0 = comparison inactive
- 1 = comparison active

**Bit 9: velocity comparison limit value 2**

- 0 = comparison inactive
- 1 = comparison active

**Bit 10: velocity comparison limit value 3**

- 0 = comparison inactive
- 1 = comparison active

**Bit 11: velocity comparison limit value 4**

- 0 = comparison inactive
- 1 = comparison active

**Bit 12: velocity comparison limit value dynamic**

- 0 = comparison inactive
- 1 = comparison active



### 9.5.8.13 Object 2050<sub>h</sub> Configuration I/O 1

Index (hex)	Sub-index (hex)	Name	Data type	Access	Value range			Remark
					Minimum	Maximum	Default	
2050	--	I/O1	u 32	rw	--	--	--	see below

The settings in "bold" correspond to the default settings

#### **Bit 0: function of the I/O 1 connection at PWR M12**

- 0 = input
- 1 = output**

#### **Bit 1: activation**

If I/O 1 is defined as input (see bit 0):

- 0 = 1 - 0 transition**
- 1 = 0 - 1 transition

If I/O 1 is defined as output (see bit 0):

- 0 = low active (the output is set to 0 if the event occurs)**
- 1 = high active (the output is set to 1 if the event occurs)

#### **Bit 2 - Bit 7: reserve**

- 0 = reserve**
- 1 = NC



#### **Notice!**

Bit 8 to bit 23 set the output via an "OR" logic.

#### **Bit 8: position limit value 1**

If the position value lies outside of configured limit value 1, the output is set.

- 0 = OFF**
- 1 = ON

#### **Bit 9: position limit value 2**

If the position value lies outside of configured limit value 2, the output is set.

- 0 = OFF**
- 1 = ON

#### **Bit 10: velocity limit value**

If the velocity value lies outside of the configured values, the output is set. Monitoring from objects 2021<sub>h</sub> to 2025<sub>h</sub> is "OR" linked to this bit.

- 0 = OFF**
- 1 = ON

**Bit 11: intensity monitoring (ATT)**

If the intensity of the received signal falls below the predefined limit value, the output is set.

- 0 = OFF
- 1 = ON

**Bit 12: temperature monitoring (TMP)**

If the internal device temperature lies outside the predefined limit values, the output is set.

- 0 = OFF
- 1 = ON

**Bit 13: laser prefailure monitoring (LSR)**

If the laser power falls below the predefined limit value, the output is set.

- 0 = OFF
- 1 = ON

**Bit 14: plausibility monitoring (PLB)**

If implausible measurement values are diagnosed, the output is set.

- 0 = OFF
- 1 = ON

**Bit 15: hardware error (ERR)**

If a hardware error is diagnosed, the output is set.

- 0 = OFF
- 1 = ON

**Bit 16 - Bit 23: reserve**

- 0 = reserve
- 1 = NC

**Bit 24 - Bit 26: function of the I/O 1, if this has been defined as an input**

- Value 000 = no function
- Value 001 = Preset teach, valid for static (object 2001) and dynamic (object 2002) preset
- Value 010 = laser OFF. Laser diode is switched off

**Bit 27 - Bit 31: reserve**

- 0 = reserve
- 1 = NC

**9.5.8.14 Object 2051<sub>n</sub> Configuration I/O 2**

Index (hex)	Sub-index (hex)	Name	Data type	Access	Value range			Remark
					Minimum	Maximum	Default	
2051	--	I/O2	u32	rw	--	--	--	see below

The settings in "bold" correspond to the default settings

**Bit 0: function of the I/O 2 connection at PWR M12**

0 = input  
**1 = output**

**Bit 1: activation**

If I/O 2 is defined as input (see bit 0):

**0 = 1 - 0 transition**

1 = 0 - 1 transition

If I/O 2 is defined as output (see bit 0):

**0 = low active (the output is set to 0 if the event occurs)**

1 = high active (the output is set to 1 if the event occurs)

**Bit 2 - Bit 7: reserve**

**0 = reserve**

1 = NC



**Notice!**

Bit 8 to bit 23 set the output via an "OR" logic.

**Bit 8: position limit value 1**

If the position value lies outside of configured limit value 1, the output is set.

**0 = OFF**

1 = ON

**Bit 9: position limit value 2**

If the position value lies outside of configured limit value 2, the output is set.

**0 = OFF**

1 = ON

**Bit 10: velocity limit value**

If the velocity value lies outside of the configured values, the output is set. The monitoring from objects 2021<sub>h</sub> to 2025<sub>h</sub> are "OR" linked to this bit.

**0 = OFF**

1 = ON

**Bit 11: intensity monitoring (ATT)**

If the intensity of the received signal falls below the predefined limit value, the output is set.

0 = OFF

**1 = ON**

**Bit 12: temperature monitoring (TMP)**

If the internal device temperature lies outside the predefined limit values, the output is set.

0 = OFF

**1 = ON**

**Bit 13: laser prefailure monitoring (LSR)**

If the laser power falls below the predefined limit value, the output is set.

0 = OFF

1 = ON

**Bit 14: plausibility monitoring (PLB)**

If implausible measurement values are diagnosed, the output is set.

0 = OFF

1 = ON

**Bit 15: hardware error (ERR)**

If a hardware error is diagnosed, the output is set.

0 = OFF

1 = ON

**Bit 16 - Bit 23: reserve**

0 = reserve

1 = NC

**Bit 24 - Bit 26: function of the I/O 2, if this has been defined as an input**

Value 000 = no function

Value 001 = Preset teach, valid for static (object 2001) and dynamic (object 2002) preset

Value 010 = laser OFF. Laser diode is switched off

**Bit 27 - Bit 31: reserve**

0 = reserve

1 = NC

**9.5.8.15 Object 2060h status and control AMS 335i**

In sub-index 01, the object provides the following status messages of the AMS 335i.

- Laser status ON/OFF
- Preset status ON/OFF
- Preset teach activated/not activated
- Monitoring lower position limit value 1
- Monitoring upper position limit value 1
- Monitoring lower position limit value 2
- Monitoring upper position limit value 2
- Intensity (ATT)
- Temperature (TMP)
- Laser (LSR)
- Plausibility (PLB)

In sub-index 02, the laser diode can be switched OFF/ON.

Index (hex)	Sub-index (hex)	Name	Data type	Access	Value range			Remark
					Minimum	Maximum	Default	
2060	01	Status	u32	ro	--	--	--	see below
	02	Laser ON/OFF	u8	rw	0	1	0	0 = laser ON 1 = laser OFF

### ***Explanations on sub-index 01***

#### ***Bit 0: hardware error (ERR)***

- 0 = ok
- 1 = hardware error (ERR)

#### ***Bit 1 - Bit 3: reserve***

- 0 = reserve
- 1 = NC

#### ***Bit 4: monitoring lower position value 1***

- 0 = OK
- 1 = value less than limit

#### ***Bit 5: monitoring upper position value 1***

- 0 = OK
- 1 = value exceeded

#### ***Bit 6: monitoring lower position value 2***

- 0 = OK
- 1 = value less than limit

#### ***Bit 7: monitoring upper position value 2***

- 0 = OK
- 1 = value exceeded

#### ***Bit 8: laser status***

- 0 = OK
- 1 = laser OFF

#### ***Bit 9: preset status***

- 0 = preset inactive
- 1 = preset active

#### ***Bit 10: preset teach (toggle bit)***

This bit toggles on each teach event of a preset value

#### ***Bit 11 - Bit 12: reserve***

- 0 = reserve
- 1 = NC

**Bit 13: intensity (ATT)**

If the intensity of the received signal falls below the predefined limit value, the warning is set.

- 0 = ok
- 1 = warning

**Bit 14: temperature (TMP)**

If the internal device temperature lies outside the predefined limit values, the warning is set.

- 0 = OK
- 1 = warning

**Bit 15: laser (LSR)**

If the laser power falls below the predefined limit value, the warning is set.

- 0 = OK
- 1 = warning

**Bit 16: plausibility (PLB)**

If implausible measurement values are diagnosed, the error is set.

- 0 = OK
- 1 = error

**Bit 17 - Bit 31: reserve**

- 0 = reserve
- 1 = NC

**9.5.8.16 Object 2070<sub>n</sub>, Behavior of the AMS 335i in the case of error**

Index (hex)	Sub-index (hex)	Name	Data type	Access	Value range			Remark
					Minimum	Maximum	Default	
2070	01	Position value in the case of error and delay for error ON/OFF	u8	rw	0	13	13	see below
	02	Position error message delay	u16	rw	100	1000	100	Delay of the error message in ms
	03	Position value in the case of error and delay for error ON/OFF	u8	rw	0	13	13	see below
	04	Error delay time - velocity	u16	rw	200	1000	200	

**Explanation on sub-index 01**

**Bit 0: position value in the case of error**

- 0 = last valid value
- 1 = zero

**Bit 1: static 0**

Bit 2: suppress position state

0 = OFF

1 = ON

**Bit 3: error delay position**

0 = OFF

1 = ON

**Explanation on sub-index 03****Bit 0: velocity value in the case of error**

0 = last valid value

1 = zero

**Bit 1: static 0****Bit 2: suppress velocity state**

0 = OFF

1 = ON

**Bit 3: error delay velocity**

0 = OFF

1 = ON

**9.5.8.17 Object 2300<sub>h</sub> Other**

Index (hex)	Sub-index (hex)	Name	Data type	Access	Value range			Remark
					Minimum	Maximum	Default	
2300	01	Display language selection	u8	rw	0	4	0	0 = English 1 = German 2 = Italian 3 = Spanish 4 = French
	02	Illumination duration display	u8	rw	0	1	0	0 = off after 10min. 1 = always on
	03	Display contrast	u8	rw	0	2	1	0 = low 1 = medium 2 = high
	04	Password activation	u8	rw	0	1	0	0 = OFF 1 = ON
	05	Password	u16	rw	0000	9999	0000	Setting of a 4-digit password
	06	Heating control	u8	rw	0	1	0	see below

**Notice!**

Password activation must be set to ON.

**Explanation on sub-index 06 "heating control"**

0 = Standard (10°C ... 15°C)

1 = Extended (30°C ... 35°C)

**Notice!**

*The sub-index 06 is available as standard, but functions only for devices with integrated heating (AMS 335i ... H).*

Sub-index 06 defines a switch-on/switch-off range for the heating control. The extended switch-on/switch-off range for heating may provide relief in the event of condensation problems. There is no guarantee that no condensation will occur on the optics in the extended switch-on/switch-off range due to the limited heating capacity.



**9.5.9 Objects of the AMS 335*i* from the DS406 class 1 encoder profile**

CANopen describes the characteristics of participants in so-called profiles.

The AMS 335*i* communicates according to the specifications in profile "DS406" class 1.

For class 1, it is mandatory to describe the following objects.

**9.5.9.1 Object 6000<sub>h</sub> Operating parameters**

Index (hex)	Sub-index (hex)	Name	Data type	Access	Value range			Remark
					Minimum	Maximum	Default	
6000	--	Operating parameters	u16	rw	0	8	0	0= positive counting direction, see below

**Bit 0 - Bit 2**

not used

**Bit 3: counting direction**

0 = positive - the measurement value increases with increasing distance.

1 = negative - the measurement value decreases with increasing distance.

Counting direction positive:

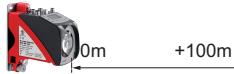

Counting direction negative:



**Bit 4 - Bit 15: reserve**

**9.5.9.2 Object 6004<sub>h</sub> Position value**

Index (hex)	Sub-index (hex)	Name	Data type	Access	Value range			Remark
					Minimum	Maximum	Default	
6004	--	Maximum position value	int 32	ro	-999999	999999	--	see below

Object 6004<sub>h</sub> contains the position value for process data objects (PDOs) 1A00<sub>h</sub> (TPDO1) and 1A01<sub>h</sub> (TPDO2).

Byte	Bit								Remark	
	7	6	5	4	3	2	1	0		
0									LSB	Maximum position value
1										
2										
3	MSB									

**9.5.9.3 Object 6500<sub>h</sub> Display of operating status from object 6000**

Index (hex)	Sub-index (hex)	Name	Data type	Access	Value range			Remark
					Minimum	Maximum	Default	
6500	--	Operating parameters	u16	ro	--	--	--	see below

**Bit 0 - Bit 2**

not used

**Bit 3: counting direction**

0 = positive - the measurement value increases with increasing distance.

1 = negative - the measurement value decreases with increasing distance.

**Bit 4 - Bit 15: reserve**

**9.5.9.4 Object 6501<sub>h</sub> Measurement step**

Index (hex)	Sub-index (hex)	Name	Data type	Access	Value range			Remark
					Minimum	Maximum	Default	
6501	--	Measurement steps	u32	ro	--	--	--	see below

The resolution set in object 2000<sub>h</sub> sub-index 03 is specified in multiples of 0.001 µm (1nm) in object 6501.

**Example:**

If the default resolution in object 2000<sub>h</sub> is set to 1 mm, the resolution for object 6501 is converted to value 1 000 000. (1 000 000 x 1/1 000 000 = 1).

## 10 Diagnostics and troubleshooting

### 10.1 Service and diagnostics in the display of the AMS 335i

In the main menu of the AMS 335i, expanded "Diagnostics" can be called up under the Service heading.

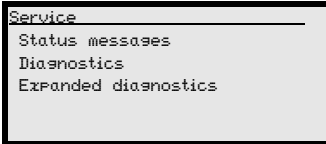

From the Service main menu, press the enter button (↵) to access the underlying menu level.

Use the up/down buttons (▲ ▼) to select the corresponding menu item in the selected level; use the enter button (↵) to activate the selection.

Return from any sub-level to the next-higher menu item by pressing the ESC button (⏏).

#### 10.1.1 Status messages

The status messages are written in a ring memory with 25 positions. The ring memory is organized according to the FIFO principle. No separate activation is necessary for storing the status messages. Power OFF clears the ring memory.

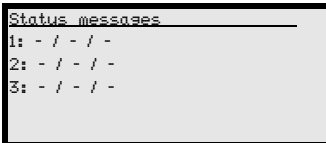

#### **Basic representation of the status messages**

**n: Type / No. / 1**

Meaning:

**n:** memory position in the ring memory

**Type:** type of message:

**I** = info, **W** = warning, **E** = error, **F** = severe system error

**No:** internal error detection

**1:** frequency of the event (always "1", since no summation occurs)

The status messages within the ring memory are selected with the up/down buttons (▲ ▼). The enter button (↵) can be used to call up **detailed information** on the corresponding status messages with the following details:

**Detailed information about a status message**

- Type:** type of message + internal counter
- UID:** Leuze internal coding of the message
- ID:** description of the message
- Info:** not currently used

Within the detailed information, the enter button (↵) can be pressed again to activate an **action menu** with the following functions:

- Acknowledge message
- Delete message
- Acknowledge all
- Delete all

**10.1.2 Diagnostics**

The diagnostics function is activated by selecting the `Diagnostics` menu item. The ESC button (ESC) deactivates the diagnostics function and clears the contents of the recordings.

The recorded diagnostic data are displayed in 2 fields. In the upper half of the display, status messages of the AMS and the bar graph are displayed. The lower half contains information that assists in a Leuze-internal evaluation.

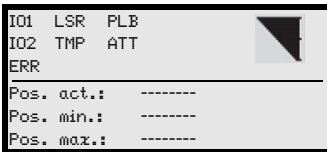

Use the up/down buttons (▲ ▼) to scroll in the bottom half between various displays. The contents of the scrollable pages are intended solely for Leuze for internal evaluation.

The diagnostics have no influence on the communication to the host interface and can be activated during operation of the AMS 335*i*.

**10.1.3 Expanded diagnostics**

The `Expanded diagnostics` menu item is used for Leuze-internal evaluation.

## 10.2 General causes of errors

### 10.2.1 Power LED

See also chapter 8.2.2.

Error	Possible error cause	Measure
PWR LED "OFF"	No supply voltage connected	Check supply voltage.
	Hardware error	Send in device.
PWR-LED "flashes red"	Light beam interruption	Check alignment.
	Plausibility error	Traverse rate >10m/s.
PWR-LED "static red"	Hardware error	For error description, see display, It may be necessary to send in the device.

Table 10.1: General causes of errors

## 10.3 Interface errors

### 10.3.1 BUS LED

For further information on the LED status displays, see chapter 8.2.2 "LED status displays".

Error	Possible error cause	Measure
BUS LED "OFF"	Power off on AMS 335 <i>i</i>	Check supply voltage.
BUS-LED "flashes red"	Invalid configuration	
BUS LED "static red"	No bus connection	
Bus LED "flashes green/red"	<ul style="list-style-type: none"> <li>- Bus error</li> <li>- Time out</li> <li>- RX /TX Buffer overflow</li> <li>- Termination error</li> </ul>	

Table 10.2: Bus error

## 10.4 Status display in the display of the AMS 335*i*

Display	Possible error cause	Measure
PLB (implausible measurement values)	Laser beam interruption	Laser spot must always be incident on the reflector.
	Laser spot outside of reflector	Traverse rate < 10m/s?
	Measurement range for maximum distance exceeded	Restrict traversing path or select AMS with larger measurement range.
	Velocity greater than 10m/s	Reduce velocity.
	Ambient temperature far outside of the permissible range (TMP display; PLB)	Select AMS with heating or ensure cooling.

Display	Possible error cause	Measure
<b>ATT</b> (insufficient received signal level)	Reflector soiled	Clean reflector or glass lens.
	Glass lens of the AMS soiled	
	Performance reduction due to snow, rain, fog, condensing vapor, or heavily polluted air (oil mist, dust)	Optimize usage conditions.
	Laser spot only partially on the reflector	Check alignment.
	Protective foil on the reflector	Remove protective foil from reflector.
<b>TMP</b> (operating temperature outside of specification)	Ambient temperatures outside of the specified range	In case of low temperatures, remedy may be an AMS with heating. If temperatures are too high, provide cooling or change mounting location.
<b>LSR</b> Laser diode warning	Laser diode prefailure message	Send in device at next possible opportunity to have laser diode replaced. Have replacement device ready.
<b>ERR</b> Hardware error.	Indicates an uncorrectable error in the hardware	Send in device for repair.



**Notice!**

Please use **chapter 10 as a master copy** should servicing be required.

Cross the items in the "Measures" column which you have already examined, fill out the following address field and fax the pages together with your service contract to the fax number listed below.

**Customer data (please complete)**

<b>Device type:</b>	
<b>Company:</b>	
<b>Contact partner / department:</b>	
<b>Phone (direct):</b>	
<b>Fax:</b>	
<b>Street / No:</b>	
<b>ZIP code/City:</b>	
<b>Country:</b>	

**Leuze Service fax number:**

**+49 7021 573 - 199**

## 11 Type overview and accessories

### 11.1 Type key

AMS 3xx i **yyy** H

Heating option	H =	With heating
Sensing distance	40	Max. operating range in m
	120	Max. operating range in m
	200	Max. operating range in m
	300	Max. operating range in m
	i =	Integrated fieldbus technology
Interface	00	RS 422/RS 232
	01	RS 485
	04	PROFIBUS DP / SSI
	08	TCP/IP
	35	CANopen
	38	EtherCAT
	48	PROFINET RT
	55	DeviceNet
	58	Ethernet/IP
	84	Interbus

AMS **A**bsolute **M**easuring **S**ystem

#### 11.1.1 Type overview AMS 335*i* (CANopen)

Type designation	Description	Part no.
AMS 335 <i>i</i> 40	40m operating range, CANopen interface	50113693
AMS 335 <i>i</i> 120	120m operating range, CANopen interface	50113694
AMS 335 <i>i</i> 200	200m operating range, CANopen interface	50113695
AMS 335 <i>i</i> 300	300m operating range, CANopen interface	50113696
AMS 335 <i>i</i> 40 H	40m operating range, CANopen interface, integrated heating	50113697
AMS 335 <i>i</i> 120 H	120m operating range, CANopen interface, integrated heating	50113698
AMS 335 <i>i</i> 200 H	200m operating range, CANopen interface, integrated heating	50113699
AMS 335 <i>i</i> 300 H	300m operating range, CANopen interface, integrated heating	50113700

Table 11.1: Type overview AMS 335*i*

## 11.2 Overview of reflector types

Type designation	Description	Part no.
Reflective tape 200x200-S	Reflective tape, 200x200mm, self-adhesive	50104361
Reflective tape 500x500-S	Reflective tape, 500x500mm, self-adhesive	50104362
Reflective tape 914x914-S	Reflective tape, 914x914mm, self-adhesive	50108988
Reflective tape 200x200-M	Reflective tape, 200x200mm, affixed to aluminum plate	50104364
Reflective tape 500x500-M	Reflective tape, 500x500mm, affixed to aluminum plate	50104365
Reflective tape 914x914-M	Reflective tape, 914x914mm, affixed to aluminum plate	50104366
Reflective tape 200x200-H	Heated reflective tape, 200 x 200 mm	50115020
Reflective tape 500x500-H	Heated reflective tape, 500 x 500 mm	50115021
Reflective tape 914x914-H	Heated reflective tape, 914 x 914 mm	50115022

Table 11.2: Overview of reflector types

## 11.3 Accessories

### 11.3.1 Accessory mounting bracket

Type designation	Description	Part no.
MW OMS/AMS 01	Mounting bracket for mounting the AMS 335 <i>i</i> to horizontal surfaces	50107255

Table 11.3: Accessory mounting bracket

### 11.3.2 Accessory deflector unit

Type designation	Description	Part no.
US AMS 01	Deflector unit with integrated mounting bracket for the AMS 335 <i>i</i> . Variable 90° deflection of the laser beam in various directions	50104479
US 1 OMS	Deflector unit without mounting bracket for simple 90° deflection of the laser beam	50035630

Table 11.4: Accessory deflector unit

### 11.3.3 Accessory M12 connector

Type designation	Description	Part no.
KD 01-5-BA	M12 connector, A-coded socket, 5-pin, BUS IN	50040097
KD 01-5-SA	M12 connector, A-coded plug, 5-pin, BUS OUT	50040098
KD 095-5A	M12 connector, A-coded socket, 5-pin, Power (PWR)	50020501

Table 11.5: Accessory M12 connector



### 11.3.4 Accessory terminating resistor

Type designation	Description	Part no.
TS 01-4-SA	120 ohm M12 terminating resistor for CANopen BUS OUT	50040099

Table 11.6: Accessory terminating resistor

### 11.3.5 Accessory ready-made cables for voltage supply

#### Contact assignment/wire color of PWR connection cable

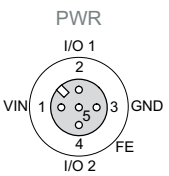
PWR connection cable (5-pin socket, A-coded)			
	Pin	Name	Core color
	1	VIN	<b>brown</b>
	2	I/O 1	<b>white</b>
	3	GND	<b>blue</b>
	4	I/O 2	<b>black</b>
	5	FE	<b>gray</b>
	Thread	FE	<b>bare</b>

#### Specifications of the cables for voltage supply

**Operating temperature range**      in rest state: -30°C ... +70°C  
 in motion: -5°C ... +70°C

**Material**      sheathing: PVC

**Bending radius**      > 50mm

#### Order codes of the cables for voltage supply

Type designation	Description	Part no.
K-D M12A-5P-5m-PVC	M12 socket, A-coded, axial plug outlet, open cable end, cable length 5m	50104557
K-D M12A-5P-10m-PVC	M12 socket, A-coded, axial plug outlet, open cable end, cable length 10m	50104559

11.3.6 Accessory ready-made cables for CANopen

Contact assignments of CANopen connection cable

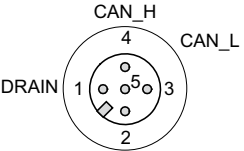
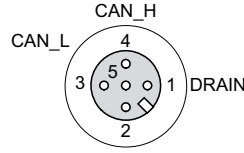
CANopen connection cable (5-pin socket/plug, A-coded)				
	Pin	Name	Core color	Remark
<p><b>BUS OUT</b></p>  <p>M12 socket (A-coded)</p> <p><b>BUS IN</b></p>  <p>M12 plug (A-coded)</p>	1	Drain	-	Shield
	2	NC	-	Not used
	3	NC	-	Not used
	4	CAN_H	white	Data signal CAN_H
	5	CAN_L	blue	Data signal CAN_L
	Thread	FE	-	Functional earth (housing)

Specifications of the CANopen connection cable

**Operating temperature range**      in rest state: -40°C ... +80°C  
 in motion: -5°C ... +80°C

**Material**      the lines comply with the CANopen requirements,  
 free of halogens, silicone and PVC

**Bending radius**      > 80mm, suitable for drag chains

**Order codes of CANopen connection cable**

Type designation	Remark	Part no.
KB DN/CAN-2000-BA	M12 socket for BUS IN, axial connector, open cable end, cable length 2 m	50114692
KB DN/CAN-5000-BA	M12 socket for BUS IN, axial connector, open cable end, cable length 5 m	50114696
KB DN/CAN-10000-BA	M12 socket for BUS IN, axial connector, open cable end, cable length 10 m	50114699
KB DN/CAN-30000-BA	M12 socket for BUS IN, axial connector, open cable end, cable length 30 m	50114701
KB DN/CAN-2000-SA	M12 plug for BUS OUT, axial connector, open cable end, cable length 2 m	50114693
KB DN/CAN-5000-SA	M12 plug for BUS OUT, axial connector, open cable end, cable length 5 m	50114697
KB DN/CAN-10000-SA	M12 plug for BUS OUT, axial connector, open cable end, cable length 10 m	50114700
KB DN/CAN-30000-SA	M12 plug for BUS OUT, axial connector, open cable end, cable length 30 m	50114702
KB DN/CAN-1000-SBA	M12 plug + M12 socket for CANopen, axial connectors, cable length 1 m	50114691
KB DN/CAN-2000-SBA	M12 plug + M12 socket for CANopen, axial connectors, cable length 2 m	50114694
KB DN/CAN-5000-SBA	M12 plug + M12 socket for CANopen, axial connectors, cable length 5 m	50114698

## 12 Maintenance

### 12.1 General maintenance information

With normal use, the laser measurement system does not require any maintenance by the operator.

#### **Cleaning**

In the event of dust build-up or if the (ATT) warning message is displayed, clean the device with a soft cloth; use a cleaning agent (commercially available glass cleaner) if necessary. Also check the reflector for possible soiling.



#### **Attention!**

*Do not use solvents and cleaning agents containing acetone. Use of such solvents could blur the reflector, the housing window and the display.*

### 12.2 Repairs, servicing



#### **Attention!**

*Access to or changes on the device, except where expressly described in this operating manual, are not authorized. The device must not be opened. Failure to comply will render the guarantee void. Warranted features cannot be guaranteed after the device has been opened.*

Repairs to the device must only be carried out by the manufacturer.

↳ *Contact your Leuze distributor or service organization should repairs be required. The addresses can be found on the inside of the cover and on the back.*



#### **Notice!**

*When sending the laser measurement systems to Leuze electronic for repair, please provide an accurate description of the error.*

### 12.3 Disassembling, packing, disposing

#### **Repacking**

For later reuse, the device is to be packed so that it is protected.

#### **Notice!**

*Electrical scrap is a special waste product! Observe the locally applicable regulations regarding disposal of the product.*

<b>A</b>		<b>F</b>	
Accessories	92	Fast commissioning	12
Accessory deflector unit	93	<b>G</b>	
Accessory M12 connector	93	General causes of errors	90
Accessory mounting bracket	93	<b>H</b>	
Accessory ready-made cables	94	Heated reflectors	
Accessory terminating resistor	94	Dimensioned drawing	31
Accuracy	14	Specifications	30
Air humidity	15	<b>I</b>	
Alignment	20	Installation	18
<b>B</b>		Interface errors	90
BUS LED	42	Interface info in display	41
<b>C</b>		Internal hardware error	41
CANopen BUS IN connections	38	<b>L</b>	
CANopen interface	52	LSR status display	91
Cleaning	97	<b>M</b>	
Connections		Main menu	
CANopen BUS OUT	39	Device information	44
PWR IN	38	Language selection	45
Service	39	Network information	44
Control buttons	43	Parameter	45
Control panel	40	Service	45
Count direction	68	Maintenance	97
<b>D</b>		Measurement range	14
Declaration of conformity	5	Measurement value output	14
Deflector unit		Menus	
Maximum ranges	24	Language selection menu	49
With integrated mounting bracket	24	Main menu	44
Without mounting bracket	26	Parameter menu	45
Deflector unit US 1 OMS		Service menu	49
Dimensioned drawing	26	Mounting	19
Deflector unit US AMS 01		with laser beam deflector unit	24
Dimensioned drawing	25	Mounting bracket(optional)	21
Description of functions	6	Mounting distances	22
Diagnostics	88	<b>N</b>	
Dimensioned drawing of AMS 3xxi	16	Name plates	18
Display	40		
<b>E</b>			
EDS file	13		
Electrical connection	37		
Safety notices	37		
Expanded diagnostics	89		
Explanation of symbols	5		

**O**

Operating principle ..... 12  
 Operating temperature ..... 15  
 Operation ..... 40, 50  
 Overview of reflector types ..... 93

**P**

Packaging ..... 18  
 Parameter enabling ..... 50, 51  
 Parameter menu  
     CANopen ..... 46  
     I/O ..... 47  
     Maximum position value ..... 46  
     Other ..... 48  
     Parameter handling ..... 45  
 Plausibility error ..... 41  
 Prefailure message ..... 41  
 PWR LED ..... 42

**Q**

Quality assurance ..... 5

**R**

Received signal ..... 41  
 Reflective tape  
     Dimensioned drawing ..... 29  
     Specifications ..... 28  
 Reflector ..... 27  
     Mounting ..... 33  
     Pitch ..... 36  
     Size ..... 32  
     Type overview ..... 32  
 Repair ..... 97

**S**

Sensing distance ..... 92  
 Servicing ..... 97  
 Specifications ..... 14  
     Dimensioned drawing ..... 16  
     General specifications ..... 14  
     Reflective tapes ..... 27  
 Status and measurement data - main menu ..... 45  
 Status- and warning messages ..... 40  
 Status display ..... 40  
     ATT ..... 91  
     ERR ..... 91  
     PLB ..... 90

TMP ..... 91  
 Status display in the display ..... 90  
 Status displays ..... 42  
 Status messages ..... 88  
 Storage ..... 18  
 Storage temperature ..... 15  
 Supply voltage ..... 14  
 Surface reflections ..... 34  
 Symbols ..... 5

**T**

Temperature monitoring ..... 41  
 Terminator plug ..... 56  
 Transport ..... 18  
 Troubleshooting ..... 88  
 Type overview ..... 17, 92

Level 1 ▲▼ : selection	Level 2 ▲▼ : selection ESC : back	Level 3 ▲▼ : selection ESC : back	Level 4 ▲▼ : selection ESC : back	Level 5 ▲▼ : selection ESC : back	Selection/configuration option ▲▼ : selection ↵ : activate ESC : back	Detailed information on
Device information						page 42
Network information						page 42
Status- and measurement data						page 42
Parameter	↵ Parameter handling	↵ Parameter enabling			ON / OFF	page 43
		↵ Password	↵ Activate password		ON / OFF	
			↵ Password entry		Configuration option of a four-digit numerical password	
		↵ Parameters to default		All parameters are reset to their factory settings		
	↵ CANopen	↵ Activation			ON / OFF	page 44
		↵ Node ID				
		↵ Baud rate			20 kbit/s / 50 kbit/s / 125 kbit/s / 250 kbit/s / 500 kbit/s / 800 kbit/s / 1 Mbit/s	
		↵ Position resolution			0.01 mm / 0.1 mm / 1 mm / 10 mm / free resolution	
		↵ Velocity resolution			1 mm / 10 mm / 100 mm / 1000 mm / free resolution	
	↵ Maximum position value	↵ Measurement unit			Metric/Inch	page 44
↵ Count direction				Positive/Negative		
↵ Offset				Value input:		
↵ Preset				Value input		
↵ Error delay				ON / OFF		
↵ Position value in the case of error				Last valid value / zero		
↵ Free resolution value				5 ... 50000		
↵ I/O	↵ I/O 1	↵ Port configuration			Input/Output	page 45
		↵ Switching input	↵ Function		No function/preset teach/laser ON/OFF	
			↵ Activation		Low active/High active	
		↵ Switching output	↵ Function		Pos. limit value 1 / Pos. limit value 2 / Velocity / Intensity (ATT) / Temp. (TMP) / Laser (LSR) / Plausibility (PLB) / Hardware (ERR)	
			↵ Activation		Low active/High active	
	↵ I/O 2	↵ Port configuration			Input/Output	
		↵ Switching input	↵ Function		No function/preset teach/laser ON/OFF	
			↵ Activation		Low active/High active	
		↵ Switching output	↵ Function		Pos. limit value 1 / Pos. limit value 2 / Velocity / Intensity (ATT) / Temp. (TMP) / Laser (LSR) / Plausibility (PLB) / Hardware (ERR)	
			↵ Activation		Low active/High active	
	↵ Limit values	↵ Upper pos. limit 1	↵ Activation		ON / OFF	
			↵ Limit value input		Value input in mm or inch/100	
		↵ Lower pos. limit 1	↵ Activation		ON / OFF	
			↵ Limit value input		Value input in mm or inch/100	
↵ Upper pos. limit 2		↵ Activation		ON / OFF		
		↵ Limit value input		Value input in mm or inch/100		
↵ Lower pos. limit 2		↵ Activation		ON / OFF		
		↵ Limit value input		Value input in mm or inch/100		

	Other	Heating control		Standard/extended (10°C ... 15°C/30°C ... 35°C)	page 46
		Display background		10 minutes/ON	
		Display contrast		Weak/Medium/Strong	
		Service RS232	Baud rate	57.6kbit/s / 115.2kbit/s	
			Format	8,e,1 / 8,n,1	
Language selection			Deutsch / English / Español / Français / Italiano	page 47	
Service	Status messages		Number of readings, reading gates, reading rate / non-reading rate etc.	page 47	
	Diagnostics		Exclusively for service purposes by Leuze electronic		
	Expanded diagnostics		Exclusively for service purposes by Leuze electronic		