

 **Leuze electronic**

the sensor people

CML 730i
Measuring light curtain

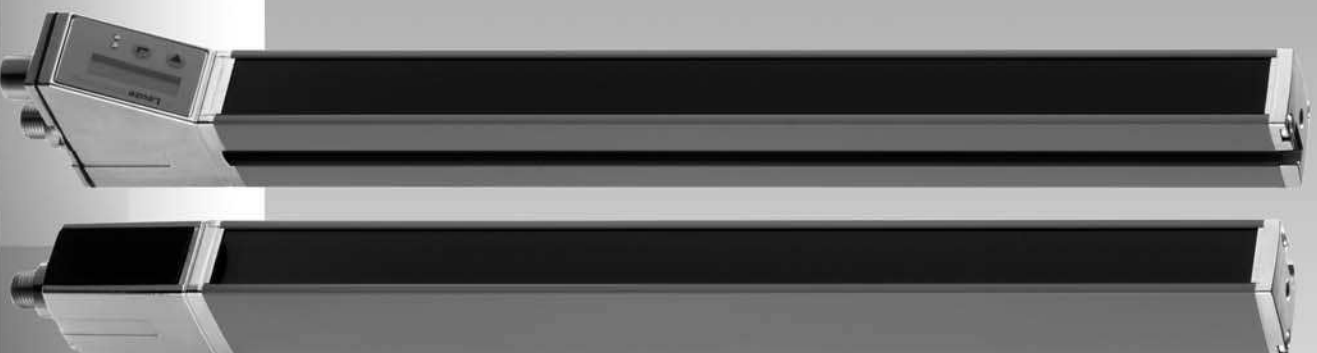

EN 2015/05 50123881
We reserve the right to
make technical changes

Leuze electronic GmbH + Co. KG
In der Braike 1
D-73277 Owen / Germany
Phone: +49 7021 573-0
Fax: +49 7021 573-199
<http://www.leuze.com>
info@leuze.de

1	About this document	8
1.1	Used symbols and signal words	8
1.2	Terms and abbreviations	8
2	Safety	11
2.1	Intended use	11
2.2	Foreseeable misuse	11
2.3	Competent persons	12
2.4	Exemption of liability	12
3	Device description	13
3.1	General information	13
3.2	General performance characteristics	13
3.3	Connection system	14
3.4	Display elements	14
3.4.1	Operation indicators on the receiver control panel	14
3.4.2	Display on the receiver control panel	15
3.4.3	Operating indicators on the transmitter	17
3.5	Operating elements on the receiver control panel	17
3.6	Menu structure of the receiver control panel	18
3.7	Menu navigation on the receiver control panel	20
3.7.1	Meaning of the display icons	20
3.7.2	Level display	20
3.7.3	Menu navigation	21
3.7.4	Editing value parameters	21
3.7.5	Editing selection parameters	22
4	Functions	24
4.1	Beam modes	24
4.1.1	Parallel	24
4.1.2	Diagonal	24
4.1.3	Crossed-beam	25
4.2	Measurement beam sequence	26
4.3	Beam-stream	27
4.4	Evaluation functions	28
4.5	Hold function	28
4.6	Blanking	28
4.7	Power-Up Teach	30
4.8	Smoothing	30
4.9	Cascading/triggering	32
4.9.1	External triggering	34
4.9.2	Internal triggering	35
4.10	Block evaluation of beam areas	36
4.10.1	Defining beam area	36
4.10.2	Autosplitting	36
4.10.3	Mapping beam area to switching output	37
4.10.4	Teach height area	38
4.11	Switching outputs	40
4.11.1	Light/dark switching	40
4.11.2	Time functions	40
4.12	Interference suppression (filter depth)	40
5	Applications	41

5.1	Height measurement	41
5.2	Object measurement	42
5.3	Width measurement, orientation detection	43
5.4	Contour measurement	44
5.5	Gap control/gap measurement	44
5.6	Hole recognition	45
6	Mounting and installation	46
6.1	Mounting the light curtain	46
6.2	Definition of directions of movement	47
6.3	Fastening via sliding blocks	48
6.4	Fastening via swivel mount	48
6.5	Fastening via swiveling mounting brackets	49
7	Electrical connection	50
7.1	Shielding and line lengths	50
7.1.1	Shielding	50
7.1.2	Cable lengths for shielded cables	52
7.2	Connection and interconnection cables	53
7.3	Device connections	53
7.4	Digital inputs/outputs on connection X1	53
7.5	Electrical connection – CML 700i with IO-Link/analog interface	54
7.5.1	X1 pin assignment – CML 700i with IO-Link interface	54
7.5.2	X1 pin assignment – CML 700i with analog interface	55
7.5.3	X2/X3 pin assignment – CML 700i with IO-Link/analog interface	56
7.6	Electrical connection – CML 700i with fieldbus interface	56
7.6.1	Pin assignment – CML 700i with fieldbus interface	57
7.6.2	X2 pin assignment – CML 700i with CANopen interface	59
7.6.3	X2 pin assignment – CML 700i with Profibus or RS 485 Modbus interface	59
7.7	Electrical supply	60
8	Starting up the device - Basic configuration	61
8.1	Aligning transmitter and receiver	61
8.2	Teaching the environmental conditions	63
8.2.1	Teach via receiver control panel	63
8.2.2	Teaching via a control signal from the control	64
8.3	Check alignment	65
8.4	Setting the function reserve	66
8.5	Extended configurations on the receiver control panel menu	67
8.5.1	Define digital inputs/outputs	67
8.5.2	Inversion of the switching behavior (light/dark switching)	70
8.5.3	Defining the filter depth	70
8.5.4	Defining the display properties	70
8.5.5	Changing the language	71
8.5.6	Product information	71
8.5.7	Reset to factory settings	72
9	Starting up the device - Analog output	73
9.1	Analog output configuration on the receiver control panel	73
9.2	Analog output configuration via the <i>Sensor Studio</i> configuration software	73
9.3	Behavior of the analog output	74
10	Starting up the device - IO-Link interface	76

10.1	Defining IO-Link device configurations on the receiver control panel	76
10.2	Defining configurations via the IO-Link master module of the PLC-specific software	76
10.3	Parameter/process data for IO-Link	77
11	Starting up the device - CANopen interface	92
11.1	Defining the CANopen basic configuration on the receiver control panel	92
11.2	Defining configurations via the PLC-specific software of the CANopen master	92
11.3	Parameter- / process data for CANopen	93
12	Starting up the device - Profibus interface	109
12.1	Defining the Profibus basic configuration on the receiver control panel	109
12.2	Defining configurations via the PLC-specific software	109
12.3	Parameter/process data for Profibus	110
12.3.1	General information on Profibus	110
12.3.2	Configuration parameters or process data	111
13	Starting up the device - RS 485 Modbus interface	120
13.1	Defining the RS 485 Modbus basic configuration on the receiver control panel	120
13.2	Defining configurations via the RS 485 Modbus interface module of the PLC software	120
13.2.1	Modbus read access	121
13.2.2	Modbus write access	122
13.2.3	Error check (CRC calculation)	122
13.2.4	Defining configurations via the PLC-specific software	124
13.3	Parameter/process data for RS 485 Modbus	125
13.4	Autosend mode	135
14	Example configurations	137
14.1	Example configuration - Reading out 64 beams (beam-stream)	137
14.1.1	Configuration of beam-stream process data via IO-Link interface	137
14.1.2	Configuration of beam-stream process data via CANopen interface	137
14.1.3	Configuration of beam-stream process data via Profibus interface	137
14.1.4	Configuration of beam-stream process data via RS 485 Modbus interface	138
14.2	Example configuration - Mapping of beams 1 ... 32 to output pin 2	138
14.2.1	Configuration of area/output mapping (general)	138
14.2.2	Configuration of an area/output mapping via IO-Link interface	139
14.2.3	Configuration of area/output mapping via CANopen interface	140
14.2.4	Configuration of area/output mapping via Profibus interface	140
14.2.5	Configuration of area/output mapping via RS 485 Modbus interface	140
14.3	Example configuration - Hole recognition	141
14.3.1	Configuration of hole recognition via IO-Link interface	141
14.3.2	Configuration of hole recognition via CANopen interface	142
14.3.3	Configuration of hole recognition via Profibus interface	142
14.3.4	Configuration of hole recognition via RS 485 Modbus interface	142
14.4	Example configuration - Activating and deactivating blanking areas	143
14.4.1	Configuration of blanking areas (general)	143
14.4.2	Configuration of blanking areas via IO-Link interface	143
14.4.3	Configuration of blanking areas via CANopen interface	144
14.4.4	Configuration of blanking areas via Profibus interface	144
14.4.5	Configuration of blanking areas via RS 485 Modbus interface	145
14.5	Example configuration - smoothing	145
14.5.1	Smoothing configuration (general)	145
14.5.2	Configuration of smoothing via IO-Link interface	145
14.5.3	Configuration of smoothing via CANopen interface	145
14.5.4	Configuration of smoothing via Profibus interface	146
14.5.5	Configuration of smoothing via RS 485 Modbus interface	146

14.6	Example configuration - Cascading	146
14.6.1	Configuration of a cascading arrangement (general)	146
14.6.2	Configuration of a cascading arrangement via IO-Link interface	148
14.6.3	Configuration of a cascading arrangement via CANopen interface	150
14.6.4	Configuration of a cascading arrangement via Profibus interface	152
14.6.5	Configuration of a cascading arrangement via RS 485 Modbus interface	154
15	Connecting to a PC – <i>Sensor Studio</i>	157
15.1	System requirements	158
15.2	Installing <i>Sensor Studio</i> configuration software and IO-Link USB master	158
15.2.1	Installing the <i>Sensor Studio</i> FDT frame	158
15.2.2	Installing drivers for IO-Link USB master	159
15.2.3	Connecting IO-Link USB master to the PC	159
15.2.4	Connect the IO-Link USB master to the light curtain	159
15.2.5	Installing the DTM and IODD	161
15.3	Starting the <i>Sensor Studio</i>	162
15.4	Short description of the <i>Sensor Studio</i> configuration software	163
15.4.1	FDT frame menu	164
15.4.2	<i>IDENTIFICATION</i> function	164
15.4.3	<i>CONFIGURATION</i> function	164
15.4.4	<i>PROCESS</i> function	165
15.4.5	<i>DIAGNOSIS</i> function	166
15.4.6	Exiting <i>Sensor Studio</i>	166
16	Troubleshooting	167
16.1	What to do in case of error?	167
16.2	Operating displays of the LEDs	167
16.3	Error codes in the display	168
17	Care, maintenance and disposal	171
17.1	Cleaning	171
17.2	Servicing	171
17.2.1	Firmware update	171
17.3	Disposing	171
18	Service and support	172
19	Technical data	173
19.1	General specifications	173
19.2	Timing	176
19.3	Minimum object diameter for stationary objects	178
19.4	Dimensional drawings	179
19.5	Dimensional drawings: Accessories	180
20	Ordering information and accessories	183
20.1	Nomenclature	183
20.2	Accessories – CML 700i with IO-Link/analog interface	184
20.2.1	IO-Link analog interface (connection in the switch cabinet: screw terminals)	185
20.2.2	IO-Link interface (connection to IO-Link master)	187
20.3	Accessories – CML 700i with CANopen, Profibus or RS 485 Modbus interface	188
20.3.1	CANopen interface	188
20.3.2	Profibus or RS 485 Modbus interface	191
20.3.3	Profibus/RS 485 Modbus interface (alternative terminating resistor)	194
20.3.4	Profibus/RS 485 Modbus interface (configuration with subsequent slave)	195

20.4	Accessories - fastening technology	195
20.5	Accessories – PC connection	196
20.6	Scope of delivery	196
21	EC Declaration of Conformity	197

1 About this document

These original operating instructions contain information regarding the proper use of the CML 700i measuring light curtain series. It is included in the delivery contents.

1.1 Used symbols and signal words

Table 1.1: Warning symbols, signal words and symbols





	Pay attention to passages marked with this symbol. Failure to observe the provided instructions could lead to personal injury or damage to equipment.
NOTICE	Signal word for property damage Indicates dangers that may result in property damage if the measures for danger avoidance are not followed.
	Symbol for tips Text passages with this symbol provide you with further information.
	Symbols for action steps Text passages with this symbol instruct you to perform actions.

Table 1.2: Operating on the display

	Main Settings	Bold text Indicates that this field is currently selected and appears highlighted in the receiver display.
	Digital IOs	Normal text Indicates that this field is not currently selected (is not highlighted in the receiver display).

1.2 Terms and abbreviations

Table 1.3: Terms and abbreviations

DTM (D evice T ype M anager)	Software device manager of the sensor
IO	Input Output
FB (F irst B eam)	First beam
FIB (F irst I nterrupted B eam)	First interrupted beam
FNIB (F irst N ot I nterrupted B eam)	First uninterrupted beam
FDT (F ield D evice T ool)	Software frame for management of device managers (DTM)
LB (L ast B eam)	Last beam
LIB (L ast I nterrupted B eam)	Last interrupted beam
LNIB (L ast N ot I nterrupted B eam)	Last uninterrupted beam
TIB (T otal I nterrupted B eams)	Number of all interrupted beams
TNIB (T otal N ot I nterrupted B eams)	Number of all uninterrupted beams (TNIB = n - TIB)
n	Number of all logical beams of a light curtain; dependent on the selected measurement field length and resolution as well as the beam mode (parallel- / diagonal- / crossed-beam scanning)
EDS	Electronic Data Sheet (EDS file for CANopen interface) Description of the device for the control

GSD	Device master data file (GSD file for Profibus interface) Description of the device for the control
IODD	IO Device Description (IODD file for IO-Link interface) Description of the device for the control
GUI (Graphical User Interface)	Graphical user interface
RTU	Remote Terminal Unit (serial RS 485 Modbus RTU mode)
PLC	Programmable Logic Control (corresponds to Programmable Logic Controller (PLC))
Response time per beam	Length of time for the evaluation of a beam
Resolution	The minimum size of an object that can be reliably detected. With parallel-beam evaluation, the smallest object to be detected corresponds to the sum of beam spacing and optic diameter.
Delay before start-up	Duration between the switching on of the supply voltage and the start of operational readiness of the light curtain
Function reserve (sensitivity adjustment)	Ratio of the optical reception power set during the teach event and the minimum light quantity required to switch the individual beam. This compensates for the light attenuation caused by dirt, dust, smoke, humidity and vapor. High function reserve = low sensitivity Low function reserve = high sensitivity
Meas. field length	Optical detection range between the first and last beam
Beam spacing	Center-to-center spacing between two beams
Cycle time	Sum of the response times of all beams of a light curtain plus the duration of the internal evaluation. Cycle time = number of beams x response time per beam + evaluation time

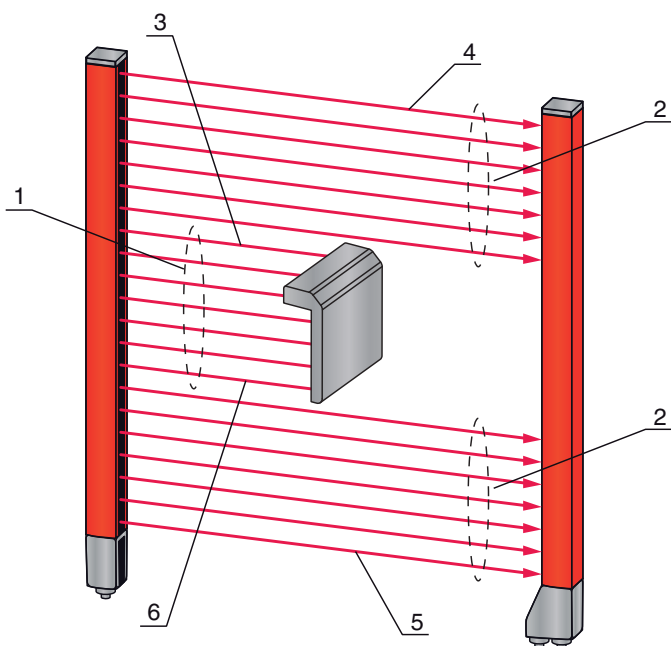

- 1 TIB (Number of all interrupted beams)
- 2 TNIB (Number of all uninterrupted beams)
- 3 LIB (Last interrupted beam)
- 4 LNIB (Last uninterrupted beam)
- 5 FNIB (First uninterrupted beam)
- 6 FIB (First interrupted beam)

Figure 1.1: Definition of terms

2 Safety

This sensor was developed, manufactured and tested in line with the applicable safety standards. It corresponds to the state of the art.

2.1 Intended use

The device is designed as a measuring and object-detecting, configurable, multi-sensor unit.

Areas of application

The measuring light curtain is designed for the measurement and detection of objects for the following areas of application in handling and warehousing systems, the packaging industry or a comparable environment:

- Height measurement
- Width measurement
- Contour measurement
- Orientation detection

 **CAUTION**

Observe intended use!

↳ Only operate the device in accordance with its intended use.

The protection of personnel and the device cannot be guaranteed if the device is operated in a manner not complying with its intended use.

Leuze electronic GmbH + Co. KG is not liable for damages caused by improper use.

↳ Read the original operating instructions before commissioning the device.

Knowledge of the original operating instructions is an element of proper use.

NOTICE

Comply with conditions and regulations!

↳ Observe the locally applicable legal regulations and the rules of the employer's liability insurance association.

2.2 Foreseeable misuse

Any use other than that defined under "Intended use" or which goes beyond that use is considered improper use.

In particular, use of the device is not permitted in the following cases:

- Rooms with explosive atmospheres
- Circuits relevant to safety
- Operation for medical purposes

NOTICE

Do not modify or otherwise interfere with the device!

↳ Do not carry out modifications or otherwise interfere with the device.

The device must not be tampered with and must not be changed in any way.

The device must not be opened. There are no user-serviceable parts inside.

Repairs must only be performed by Leuze electronic GmbH + Co. KG.

2.3 Competent persons

Connection, mounting, commissioning and adjustment of the device must only be carried out by competent persons.

Prerequisites for competent persons:

- They have a suitable technical education.
- They are familiar with the rules and regulations for occupational safety and safety at work.
- They are familiar with the original operating instructions of the device.
- They have been instructed by the responsible person on the mounting and operation of the device.

Certified electricians

Electrical work must be carried out by a certified electrician.

Due to their technical training, knowledge and experience as well as their familiarity with relevant standards and regulations, certified electricians are able to perform work on electrical systems and independently detect possible dangers.

In Germany, certified electricians must fulfill the requirements of accident-prevention regulations BGV A3 (e.g. electrician foreman). In other countries, there are respective regulations that must be observed.

2.4 Exemption of liability

Leuze electronic GmbH + Co. KG is not liable in the following cases:

- The device is not being used properly.
- Reasonably foreseeable misuse is not taken into account.
- Mounting and electrical connection are not properly performed.
- Changes (e.g., constructional) are made to the device.

3 Device description

3.1 General information

The light curtains of the CML 700i series are designed as measuring and object-detecting, configurable, multi-sensor units. Depending on the configuration and model, the devices are suitable for a variety of tasks with various resolutions and can be integrated in different control environments.

The total system of the light curtain consists of a transmitter and a receiver, including the connection and interconnection cables.

- Transmitter and receiver are connected to one another via a synchronization cable.
- The integrated control panel with indicators and operational controls for configuring the total system is located on the receiver.
- The shared power supply is provided via connection X1 on the receiver.

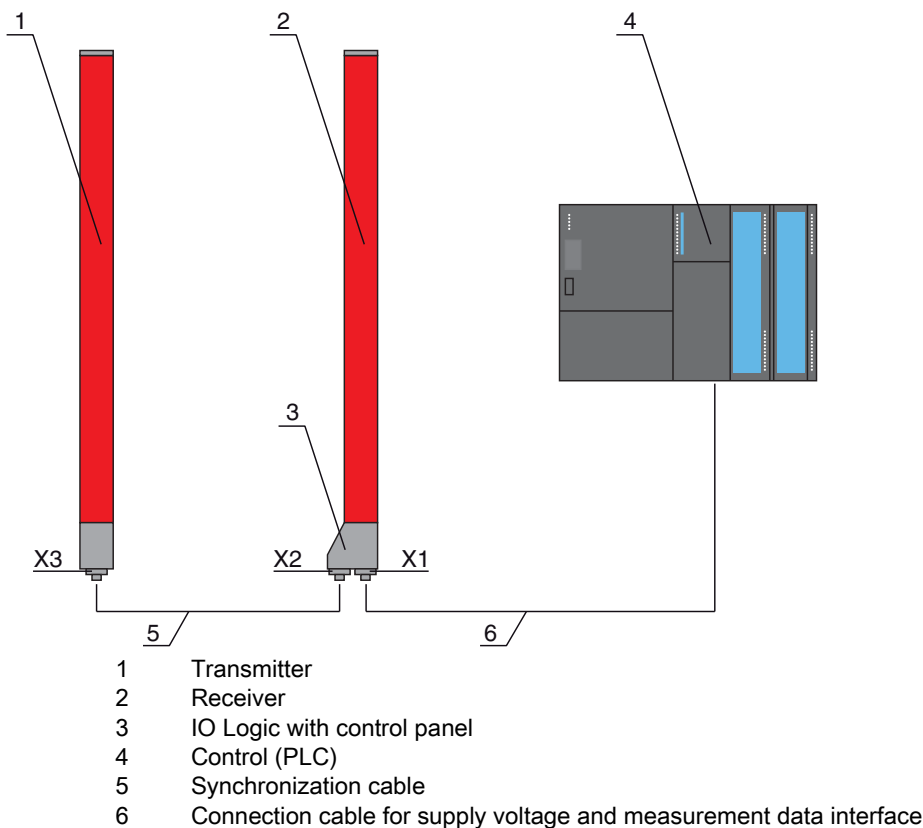

Figure 3.1: Total system in combination with a programmable logic control

3.2 General performance characteristics

The most important performance characteristics of the CML 730i series are:

- Operating range up to 8000 mm
- Measurement field length from 150 mm to 2960 mm
- Beam spacings of 5 mm, 10 mm, 20 mm, 40 mm
- Response time 10 µs per beam
- Beam modes: parallel, diagonal, crossed-beam
- Single-beam evaluation (beam-stream)
- Evaluation functions: TIB, TNIB, LIB, LNIB, FIB, FNIB, status of beam areas 1 ... 32, status of the digital inputs/outputs
- Local control panel with display
- Interfaces to the machine control:
 - IO-Link:
 - 4 digital inputs/outputs (configurable)

- CANopen, Profibus-DP, RS 485 Modbus:
2 digital inputs/outputs (configurable) plus IO-Link
- Analog:
2 analog current/voltage outputs plus IO-Link
2 digital inputs/outputs (configurable)
- Blanking of unnecessary beams
- Smoothing for interference suppression
- Cascading of multiple devices
- Block evaluation of beam areas
- Position / hole recognition with continuous web material
- Detection of transparent media

3.3 Connection system

The transmitter and receiver feature an M12 connector with the following number of pins:

Device type	Designation on device	Plug/socket
Receiver	X1	M12 plug (8-pin)
Receiver	X2	M12 socket (5-pin)
Transmitter	X3	M12 plug (5-pin)

3.4 Display elements

The display elements show the device status in operation and provide support during commissioning and error analysis.

Located on the receiver is a control panel with the following display elements:

- two LEDs
- one OLED display (Organic Light-Emitting Diode), two-line

Located on the transmitter is the following display element:

- one LED

3.4.1 Operation indicators on the receiver control panel

Two function indicator LEDs are located on the receiver control panel.



Figure 3.2: LED indicators on the receiver

Table 3.1: Meaning of the LEDs on the receiver

LED	Color	State	Description
1	Green	ON (continuous light)	Light curtain ready (normal mode)
		Flashing	see chapter 16.2
		OFF	Sensor not ready
2	Yellow	ON (continuous light)	All active beams are free - with function reserve
		Flashing	see chapter 16.2
		OFF	At least one beam interrupted (object detected)

3.4.2 Display on the receiver control panel

Located on the receiver is an OLED display which serves as a function indicator.



Figure 3.3: OLED display on the receiver

The type of display on the OLED display is different for the following operating modes:

- Alignment mode
- Process mode

Display indicators in alignment mode

In alignment mode, the OLED display shows the received signal level of the first (FB) and last (LB) beam via two bar graph indicators.

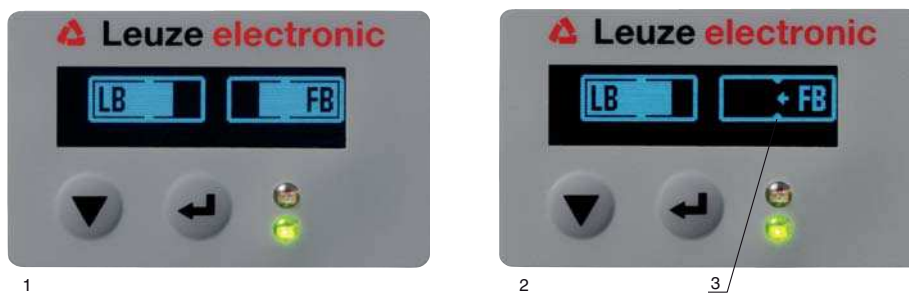

- 1 Evenly aligned light curtain
- 2 No reception signal from first beam (FB); good reception signal from last beam (LB)
- 3 Marker for the minimum signal level which is to be achieved

Figure 3.4: OLED display on the receiver in alignment mode

Display indicators in process mode

In process mode, the upper line shows the number of interrupted beams (TIB) and the lower line shows the logic state of the digital outputs.

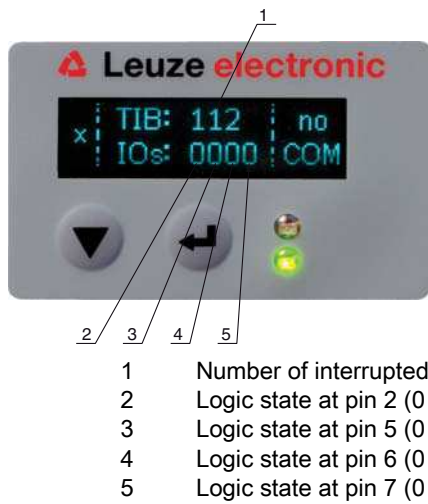

Figure 3.5: OLED display on the receiver in process mode



If the control panel is not used for several minutes, the display darkens and switches off. Press a function button to again make the display visible. Settings for visibility, display duration, etc. can be changed via the Display menu.

3.4.3 Operating indicators on the transmitter

Located on the transmitter is an LED which serves as a function indicator.

Table 3.2: Meaning of the LED on the transmitter

LED	Color	State	Description
1	Green	ON (continuous light or flashing in sync with the measurement)	Light curtain operates continuously with maximum measurement frequency
		OFF	No communication with the receiver Light curtain waits for external trigger signal

3.5 Operating elements on the receiver control panel

Located on the receiver below the OLED display is a membrane keyboard with two function buttons for entering various functions.



Figure 3.6: Function buttons on the receiver

3.6 Menu structure of the receiver control panel

The following summary shows the structure of all menu items. In a given device model, only the actually available menu items are present for entering values or for selecting settings.

Menu level 0

Level 0

Main Settings
Digital IOs
Analog Output
Display
Information
Exit

Menu "Main Settings"

Level 1	Level 2	Description			
Command		Teach	Reset	Factory Settings	Exit
Operational setting	Filter Depth	(enter value) min = 1 max = 255			
	Beam mode	Parallel	Diagonal	Crossed-beam	
	Function reserve	High	Medium	Low	Transparent
	Switching threshold	(enter value) min = 10 max = 98			
	Blanking Teach	Inactive Active			
	Power-Up Teach	Inactive Active			
	Smoothing	(enter value) min = 1 max = 255			
IO-Link	Bit rate	COM3: 230.4 kbit/s	COM2: 38.4 kbit/s		
	PD Length	2 bytes	8 bytes	32 bytes	
	Data Storage	Deactivated	Activated		
CANopen	Node ID	(enter value) min = 1 max = 127			
	Bit rate	1000 kbit/s	500 kbit/s	250 kbit/s	125 kbit/s
Profibus	Slave address	(enter value) min = 1 max = 126			
	Bit rate	3000 kbit/s	1500 kbit/s	500 kbit/s	187.5 kbit/s
		93.75 kbit/s	45.45 kbit/s	19.2 kbit/s	9.6 kbit/s
RS 485 Modbus	Slave address	(enter value) min = 1 max = 247			
	Bit rate	921.6 kbit/s	115.2kbit/s	57.6kbit/s	38.4 kbit/s
		19.2 kbit/s	9.6 kbit/s	4.8 kbit/s	
	Parity	none	Straight	Not straight	
	Silent Interval	0 =auto	(enter value) min = 1 max = 300		

Menu "Digital IOs"

Level 1	Level 2	Description
IO Logic		Positive PNP Negative NPN
IO Pin 2 IO Pin 5 IO Pin 6 IO Pin 7	IO Function	Trigger In Teach In Area Out Warn Out Trigger Out
	Inversion	Normal Inverted
	Teach height	Execute Exit
	Area Logic	AND OR
	Start Beam	(enter value) min = 1 max = 1774
	End Beam	(enter value) min = 1 max = 1774

Menu "Analog output"

Level 1	Level 2	Description
Analog Signal		Off U: 0 ... 5 V U: 0 ... 10 V U: 0 ... 11 V I: 4 ... 20 mA I: 0 ... 20 mA I: 0 ... 24 mA
Analog Function		Off FIB FNIB LIB LNIB TIB TNIB
Start Beam		(enter value) min = 1 max = 1774
End Beam		(enter value) min = 1 max = 1774

Menu "Display"

Level 1	Level 2	Description
Language		English German French Italian Spanish
Mode		Process mode Alignment
Visibility		Off Dark Normal Bright Dynamic
Time Unit (s)		(enter value) min = 1 max = 240
Evaluation function		TIB TNIB FIB FNIB LIB LNIB









Menu "Information"

Level 1	Level 2	Description
Product name		CML 730i
Product ID		Receiver part no. (e.g., 50119835)
Serial number		Receiver serial number (e.g., 01436000288)
Tx.transmitter-ID		Transmitter part no. (e.g., 50119407)
Tx.transmitter-SN		Transmitter serial no. (e.g., 01436000289)
FW version		e.g., 01.61
HW version		e.g., A001
Kx version		e.g., P01.30e

3.7 Menu navigation on the receiver control panel

The ▼ and ↵ buttons have different functions depending on the operating situation. These functions are displayed at the left edge of the display above the icons.

3.7.1 Meaning of the display icons



Icon	Position	Function
	First line	Symbolizes that you can select the next parameter within a menu level by pressing the ▼ button.
	First line	Symbolizes that you have reached the lowest menu level (not highlighted).
	Second line	Symbolizes the respective, next menu level that you have not yet selected (not highlighted).
	Second line	Press the ↵ button to exit the menu level or the menu.
	Second line	Symbolizes the input mode. The selected (highlighted) option field can be a fixed selection parameter or a multi-digit input field. With a multi-digit input field, you can increase the active digit by one with the ▼ button and use the ↵ button to switch from one digit to the next.
	Second line	Symbolizes the confirmation of a selection. This icon appears when you complete an option field with the ↵ button.
	Second line	Symbolizes the rejection of a selection. This icon is accessed from the previous icon (check mark) by pressing the ▼ button. This mode allows you to reject the current value or option parameter by pressing the ↵ button.
	Second line	Symbolizes the return to the selection. This icon is accessed from the previous icon (cross) by pressing the ▼ button. This mode allows you to reset the current value or option parameter for the purpose of entering a new value or selecting an option parameter by pressing the ↵ button.

3.7.2 Level display

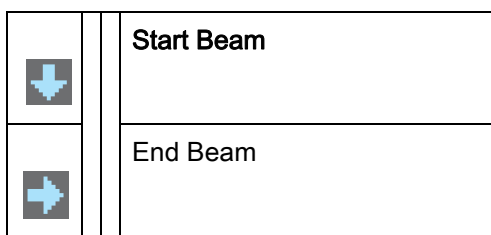
The display of bars between icons and text that span both lines indicates the open menu levels. The example shows a configuration in the menu level 2:





3.7.3 Menu navigation



	Main Settings
	Digital IOs

- ▼ Selects the next menu item (“Digital IOs”); the other menu items follow if pressed again.
- ← Selects the highlighted submenu (“Main Settings”).

3.7.4 Editing value parameters



	Start Beam
	End Beam

- ← Selects the “Start Beam” menu item with the bright background.

	Start Beam
	0001



- ▼ Changes the value of the first digit (0).
- ← Selects additional numbers for configuring values.

After entering the last number, the total value can be saved, rejected or reset.



	Start Beam
	0010



- ← Saves the new value (0010).
- ▼ Changes the action mode; first  and then  appears on the second line.

If the selected option is not saved in the window above, but rather the  action mode is selected with the ▼ button, this means:

	Start Beam
	0010



↩ Rejects the current input value. The display returns to the higher-order menu level: Start Beam/End Beam

If the  action mode is selected with the  button, this means:



	Start Beam
	0010

↩ Resets the current input value (0001) and allows the entry of new values.

3.7.5 Editing selection parameters

	IO Logic
	IO Pin 2



↩ Selects the “IO Logic” menu item with the bright background.



	IO Logic
	Positive PNP

▼ With each actuation, displays the next option on this menu level, i.e., the display switches between:

- Negative NPN
- Positive PNP

↩ Selects the “Positive PNP” menu item with the bright background.

	IO Logic
	Positive PNP

- ▼ Changes the action mode;  appears; subsequent actuation displays  or  again.
- ← Saves the selected option "Positive PNP".

4 Functions

This chapter describes the functions of the light curtain for adaptation to different applications and operating conditions.

4.1 Beam modes

4.1.1 Parallel

In “parallel”-beam mode (parallel-beam scanning), the light beam of each transmitter LED is detected by the directly opposing receiver LED.

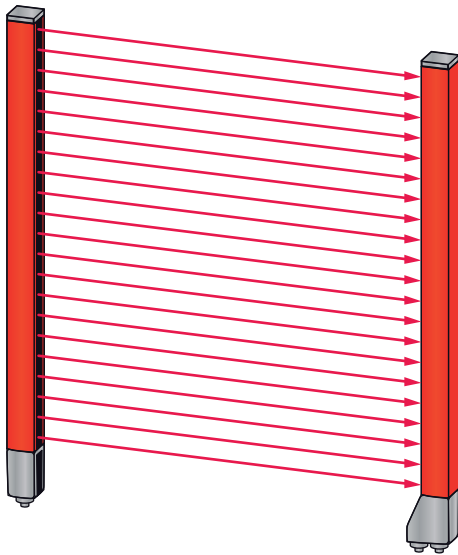
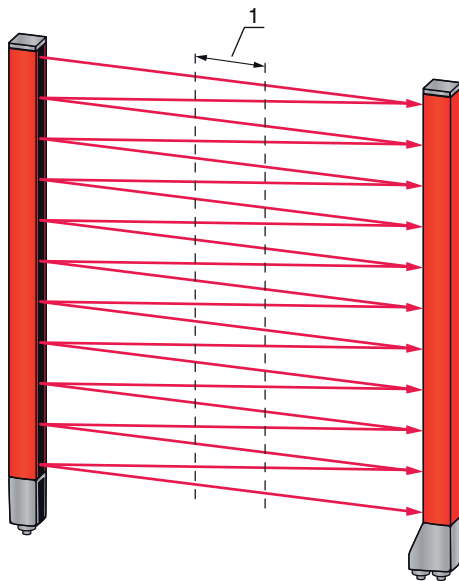

Figure 4.1: Beam path in “parallel” beam mode

4.1.2 Diagonal

In “diagonal” beam mode, the light beam of each transmitter diode is received in succession both by the directly opposing receiver diode as well as by the next receiver diode in the counting direction (i-1) (parallel and diagonal beam path). This increases the resolution in the middle between the transmitter and receiver.



1 Area with increased resolution

Figure 4.2: Beam path in “diagonal” beam mode

Calculation

The number of beams for diagonal-beam scanning n_d is calculated from the number of beams for parallel-beam scanning n_p .

Formula for calculating the number of beams for diagonal-beam scanning

$$n_d = 2n_p - 1$$

n_d [number] = number of beams for diagonal-beam scanning
 n_p [number] = number of beams for parallel-beam scanning

Example: 288 beams in parallel-beam scanning become 575 logical individual beams in diagonal-beam scanning, which must be taken into account during evaluation functions. With a beam spacing of 5 mm, this spacing is reduced to 2.5 mm in the center area.

 The “diagonal” beam mode (diagonal-beam scanning) can be activated via the respective field-bus interface (see chapter 10 et seq.) or via the *Sensor Studio* configuration software (see chapter 15).

NOTICE

Minimum distance for diagonal-beam scanning!

↪ For diagonal-beam scanning, the minimum distance that must be maintained between transmitter and receiver changes, whereby the values vary depending on beam spacing (see chapter 19).

NOTICE

Teach after changing the beam mode!

↪ Changing the beam mode changes the number of beams used for the evaluation. Perform a teach after changing the beam mode (see chapter 8.2).

4.1.3 Crossed-beam

The “crossed-beam” mode (crossed-beam scanning) is available for increasing the resolution for an area of the measurement field. In “crossed-beam” mode, the light beam of each transmitter LED is detected in succession both by the directly opposing receiver LED as well as by the two adjacent receiver LEDs (i+1, i-1).

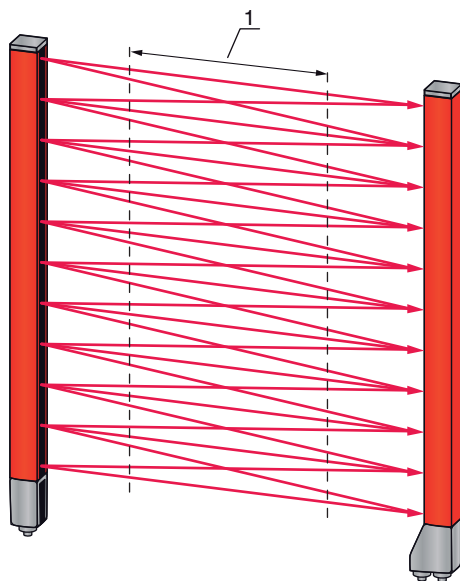

1 Area with increased resolution

Figure 4.3: Beam path in “crossed-beam” mode

Calculation

The number of beams for crossed-beam scanning n_k is calculated from the number of beams for parallel-beam scanning n_p .

Formula for calculating the number of beams for crossed-beam scanning

$$n_k = 3n_p - 2$$

- n_k [number] = number of beams for crossed-beam scanning
- n_p [number] = number of beams for parallel-beam scanning

NOTICE

Minimum distance for crossed-beam scanning!

↪ For crossed-beam scanning, the minimum distance that must be maintained between transmitter and receiver changes, whereby the values vary depending on beam spacing (see chapter 19).

Example: 288 beams in parallel-beam scanning become 862 logical beams in crossed-beam scanning. With a beam spacing of 5 mm, this spacing is reduced to 2.5 mm in the center area.

 The “crossed-beam” mode (crossed-beam scanning) can be activated via the respective fieldbus interface (see chapter 10 et seq.) or via the *Sensor Studio* configuration software (see chapter 15).

4.2 Measurement beam sequence

By default, the counting direction of the beams begins at the sensor connection unit. It can, however, be reconfigured so that counting begins with 1 at the sensor head.

The simplest application case for the inverted beam sequence is vertical mounting with the connection unit at the top, e.g., for height measurement, where beam 1 is to begin at the bottom:

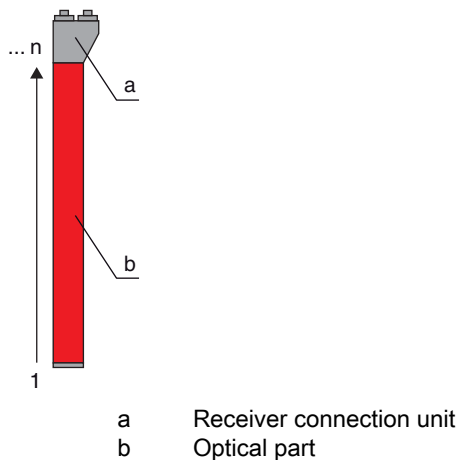

Another variant with two successive light curtains, where the second is rotated by 180° and counting again begins with 1, is illustrated as follows:

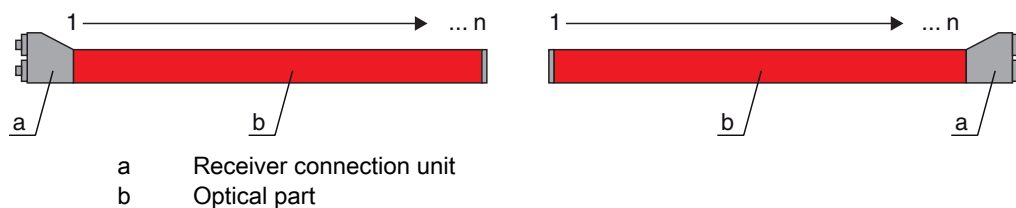

For width detection, counting can begin with 1 at either end at the head part of the sensor as shown below:

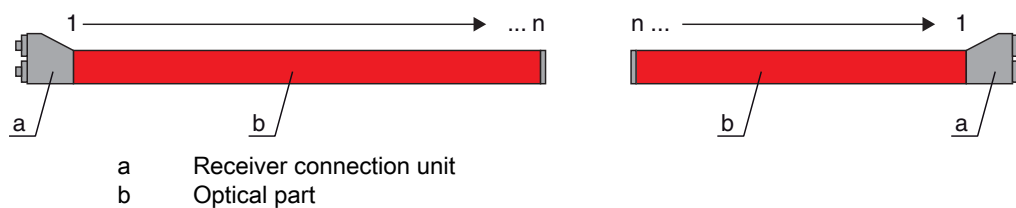

 The counting direction can be changed via the respective fieldbus interface (see chapter 10 et seq.) or via the *Sensor Studio* configuration software (see chapter 15).

4.3 Beam-stream

The beam-stream evaluation returns the status of each individual beam (see figure 4.4). Uninterrupted beams (free beams) are represented as logical 1 in the output bit in this case.

 The data is available via the respective fieldbus interface (see chapter 10 et seq.) or via the *Sensor Studio* configuration software (see chapter 15).

For an example configuration, see chapter 14.1.

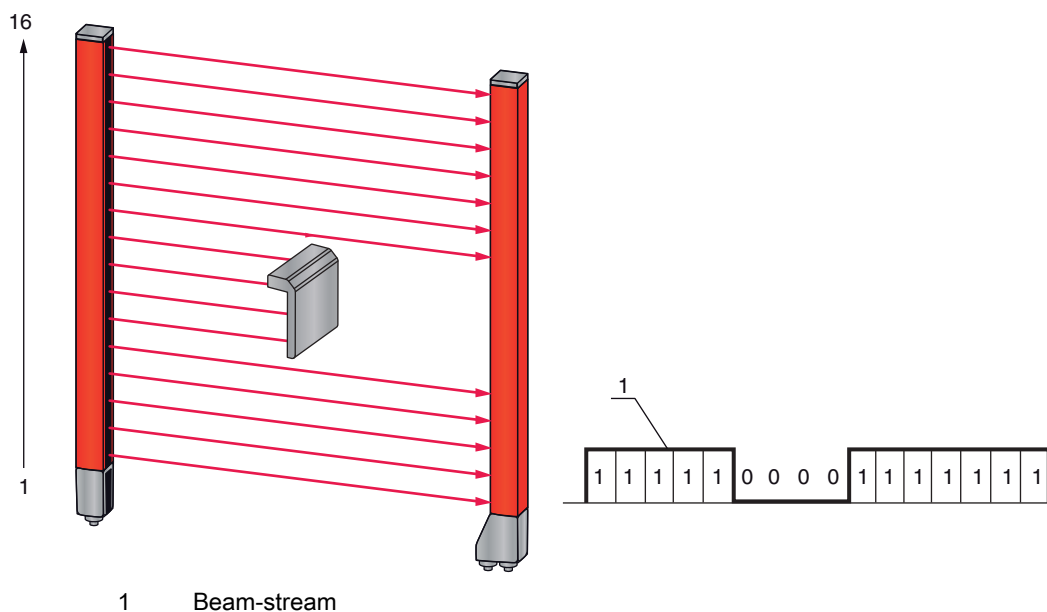

Figure 4.4: Example: beam-stream evaluation

4.4 Evaluation functions

The states of the individual optical beams (free/interrupted) can be evaluated in the CML 700i and the result read out via various evaluation functions.

The most important evaluation functions are shown in the following figure:

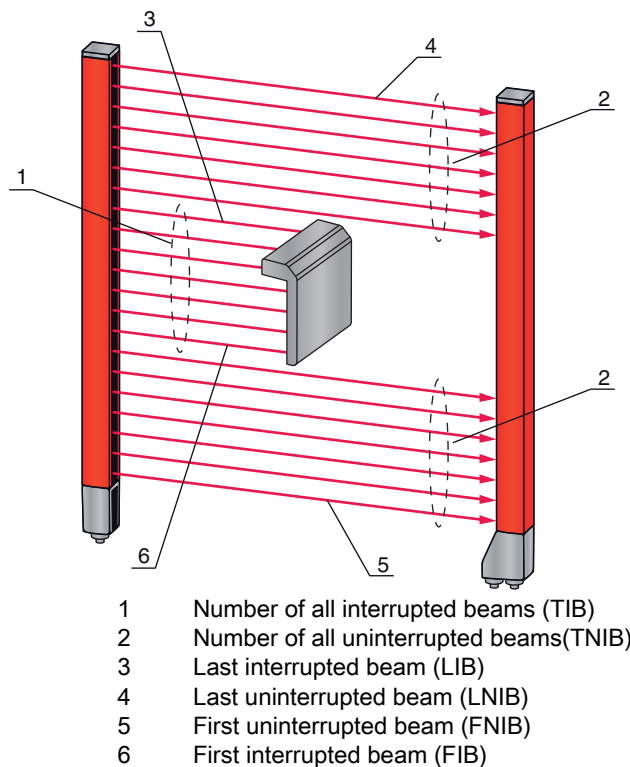

Figure 4.5: Evaluation functions

Also included among the evaluation functions are:

- the status of beam areas 1 ... 32
- the status of the digital inputs/outputs

For the beam area mappings to an output pin or the status of the digital inputs/outputs, see chapter 4.10.

4.5 Hold function



The setting of the hold times is performed via the respective fieldbus interface (see chapter 10 et seq.) or via the *Sensor Studio* configuration software (see chapter 15).

The minima and maxima of the following evaluation functions can be temporarily stored for an adjustable period of time via this function:

- First interrupted beam (FIB)
- First uninterrupted beam (FNIB)
- Last interrupted beam (LIB)
- Last uninterrupted beam (LNIB)
- Number of all interrupted beams (TIB)
- Number of all uninterrupted beams (TNIB)

This simplifies the reading out of the measurement results if the used control cannot transmit the data at the same speed that the light curtain makes the data available.

4.6 Blanking

If light curtains are installed such that existing frames / cross bars etc. continuously interrupt some beams, these beams must be suppressed.

During blanking, beams that are not to be included in the evaluation are suppressed. The numbering of the beams is not affected, i.e., the suppression of beams does not change the beam numbers.

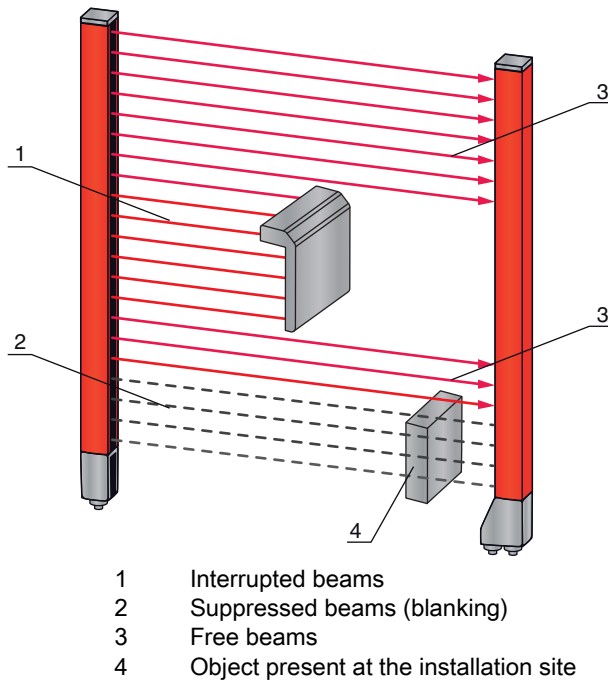

Figure 4.6: Beam states



Up to four adjacent beam areas can be suppressed.



The beams can be activated or suppressed via the respective fieldbus interface (see chapter 10 et seq.), via the *Sensor Studio* configuration software (see chapter 15) and partially via the operational controls on the receiver.

The behavior of each blanking area can be adapted to the requirements of the application:

Logical value of a blanking area	Meaning in the application
No beams are blanked	All beams of the device are included in the evaluation.
Logical value 0 for blanked beams	All beams of the blanking area are taken into account as interrupted beams (logical value 0) in the evaluation.
Logical value 1 for blanked beams	All beams of the blanking area are taken into account as free beams (logical value 1) in the evaluation.
Logical value is the same as the adjacent beam with lower beam number	All beams of the blanking area behave in the evaluation like the previous beam.
Logical value is the same as the adjacent beam with higher beam number	All beams of the blanking area behave in the evaluation like the subsequent beam.

For an example configuration, see chapter 14.4.

NOTICE

Teach after changing the blanking configuration!

👉 Perform a teach after changing the blanking configuration (see chapter 8.2).

Auto blanking during teaching

If there are obstacles present in the measurement field at the installation site and at least one blanking area is activated, interrupted beams can be mapped to the blanking area(s) during teaching. Existing



settings for the blanking areas are then overwritten (see chapter 8.2).
 If no beams are interrupted during teaching, no blanking areas are configured.

 Auto blanking cannot be used to detect transparent objects.

 Deactivated beams are lost if the beam mode is changed while auto blanking is active.

NOTICE
Deactivate auto blanking in process mode!
<ul style="list-style-type: none">  Deactivate auto blanking in process mode. Activate auto blanking only during commissioning of the device to suppress distracting objects.

NOTICE
Deactivate auto blanking during Power-Up Teach!
<ul style="list-style-type: none">  Deactivate auto blanking if “Power-Up Teach” is activated (see chapter 4.7).

NOTICE
Resetting all blanking areas!
<ul style="list-style-type: none">  To deactivate blanking areas, leave auto blanking active with at least the same number of blanking areas. Perform a new teach in a free measurement field.  To deactivate blanking with the <i>Sensor Studio</i> configuration software, configure the number of blanking areas as zero and, at the same time, deactivate each area. Perform a new teach.

4.7 Power-Up Teach

After applying operating voltage, the “Power-Up Teach” function performs a teach event when the device is ready for operation.

- If the Power-Up teach is successful, the new teach values are adopted if they are different from the previously stored teach values.
- If the Power-Up teach is not successful (e.g. object in the light path), the previously saved teach values are used.

 The “Power-Up Teach” event can only be activated via the receiver control panel.

NOTICE
Deactivate auto blanking during Power-Up Teach!
<ul style="list-style-type: none">  Deactivate auto blanking if “Power-Up Teach” is activated.

NOTICE
No objects in the light path!
<ul style="list-style-type: none">  During “Power-Up Teach”, ensure that no beams are partially covered by an object.

4.8 Smoothing

With the smoothing function, interrupted beams are then only taken into account in the evaluation if the set minimum number of adjacent beams is reached at the same time.

Smoothing can be used, e.g., to suppress interference caused by spot soiling of the lens cover. Smoothing “1” means that every interrupted beam is evaluated.

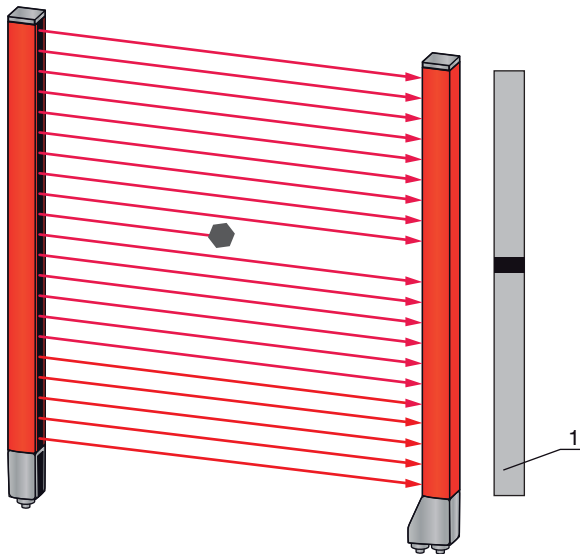

1 Data output: beam number x interrupted

Figure 4.7: Smoothing configuration “1”

If smoothing is set to a value of “3”, for example, data is only output if at least three adjacent beams are interrupted.

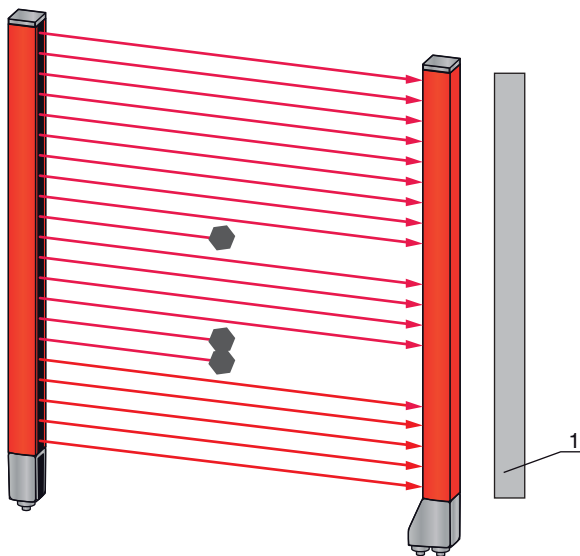

1 Data output: 0 beams interrupted

Figure 4.8: Smoothing configuration “3”, but no more than two adjacent beams interrupted

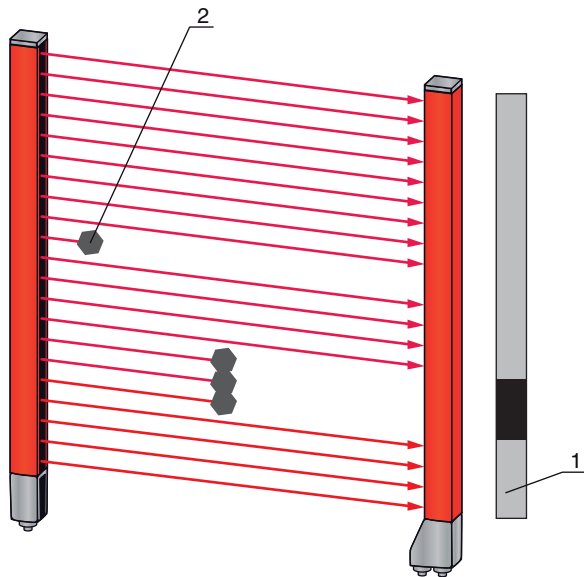

- 1 Data output: beam numbers from ... to ... interrupted
- 2 Interrupted beam is not taken into account

Figure 4.9: Smoothing configuration “3”, and three or more adjacent beams interrupted

NOTICE
Configuration values for smoothing!
↪ Values from 1 to 255 can be entered for smoothing.

Inverted smoothing

Inverted smoothing can suppress interference near the edges of objects, since uninterrupted beams are not evaluated until the set number is reached.

With inverted smoothing it is possible to detect, e.g., only successive openings of a certain minimum size within a web.

For an example configuration, see chapter 14.5.

4.9 Cascading/triggering

If the measurement field length of a light curtain is not sufficient for detecting a desired measurement path, multiple light curtains can be connected in series or cascaded. When doing so, it must be ensured that the light curtains do not mutually influence or interfere with one another. This is ensured by activating (triggering) with a time offset.

The following light curtain arrangements are possible in a cascade arrangement:

- Multiple light curtains above one another, e.g., for height monitoring

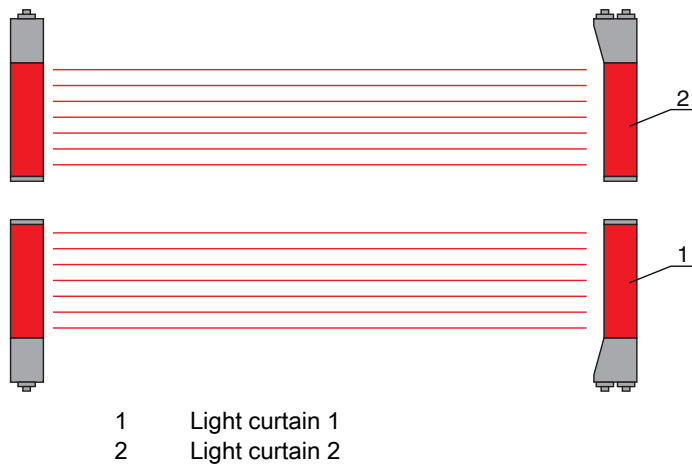

Figure 4.10: Simple cascading with two light curtains for height monitoring

- Multiple light curtains in a rectangular frame, e.g., for object measurement of height and width along a transport system.

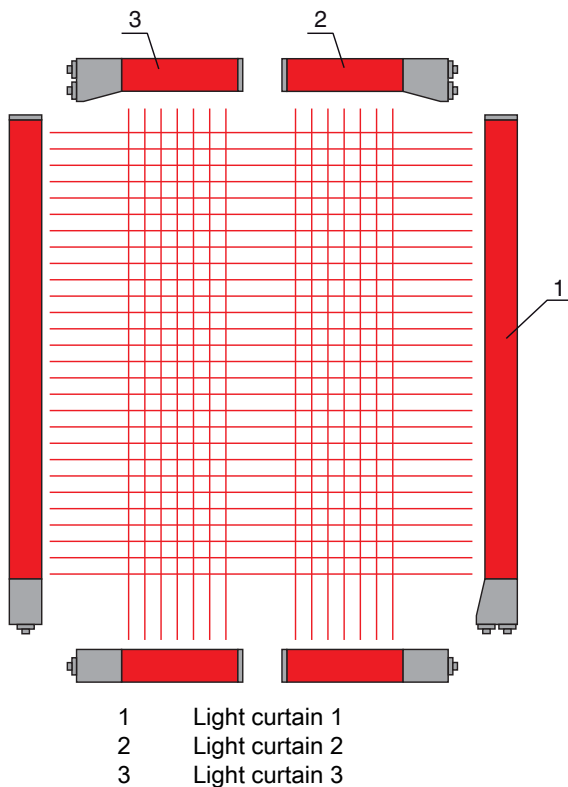

Figure 4.11: Simple cascading with three light curtains for object measurement



The selection of activation via an internal or external trigger signal is made via the respective fieldbus interface (see chapter 10 et seq.) or via the *Sensor Studio* configuration software (see chapter 15).

NOTICE

Cascading necessary for multiple-track transport systems!

↪ Cascade light curtains for multiple-track transport systems.

↪ Prevent mutual interference through sequential activation of the light curtains.

If the spatial configuration excludes mutual interference, multiple light curtains can also be activated simultaneously.

4.9.1 External triggering

Trigger input

For an exact time assignment, it is possible to start the measurement cycle of a light curtain in a targeted manner by means of a pulse at the trigger input. In this way, mutual interference can be prevented in applications with multiple light curtains. This trigger signal generated in the control must be wired at all cascaded light curtains.

The individual light curtains are configured so that the respective measurement is started with different delay times to the trigger pulse (see figure 4.12).

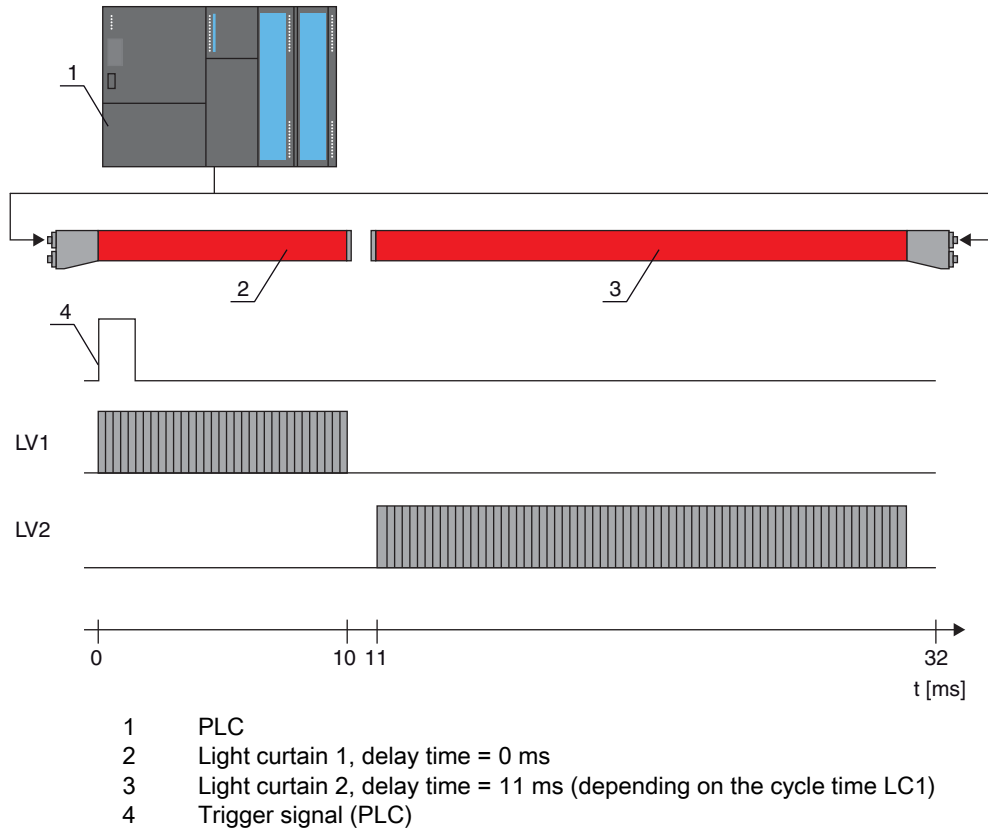



Figure 4.12: Activation via external trigger

4.9.2 Internal triggering

With internal trigger activation, a CML 700i configured as "master light curtain" generates the trigger pulse. This trigger pulse is continuous; this means that no further activation is required from a primary control.

Trigger output

The trigger output of the master light curtain makes available the trigger signal necessary for "cascading via internal trigger". The trigger output must be wired to the trigger inputs of the slave light curtains (see figure 4.13). This is used to start the measurement in the configured time sequence.

-  The cycle time of the respective light curtain can be read out via the *Sensor Studio* configuration software (see chapter 15) or via the respective fieldbus interface (see chapter 10 et seq.).
-  The selection of activation via an internal or external trigger signal is made via the respective fieldbus interface (see chapter 10 et seq.) or via the *Sensor Studio* configuration software (see chapter 15).

For an example configuration, see chapter 14.6.

The following figure shows a wiring example for the cascading of three light curtains via internal trigger:

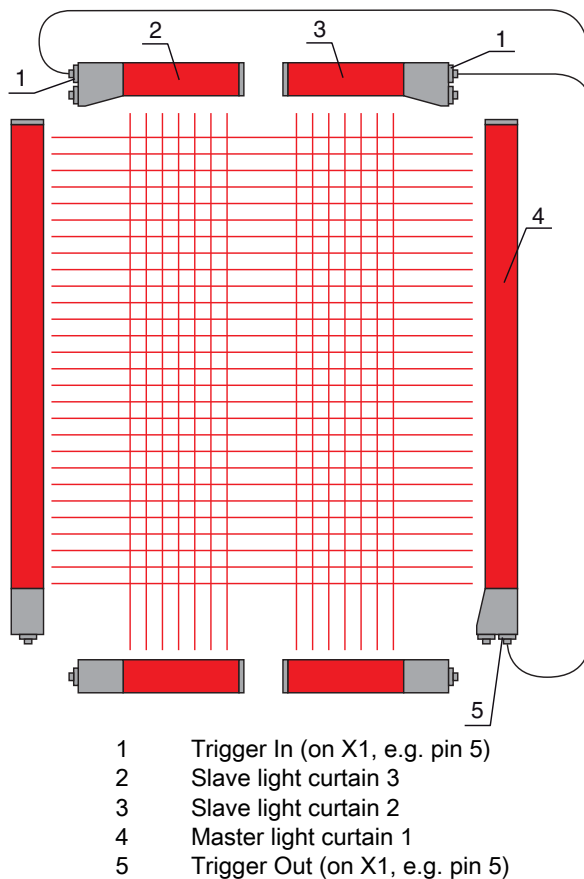

Figure 4.13: Wiring example of three light curtains via internal trigger

The following example shows a configuration of three light curtains via internal trigger.

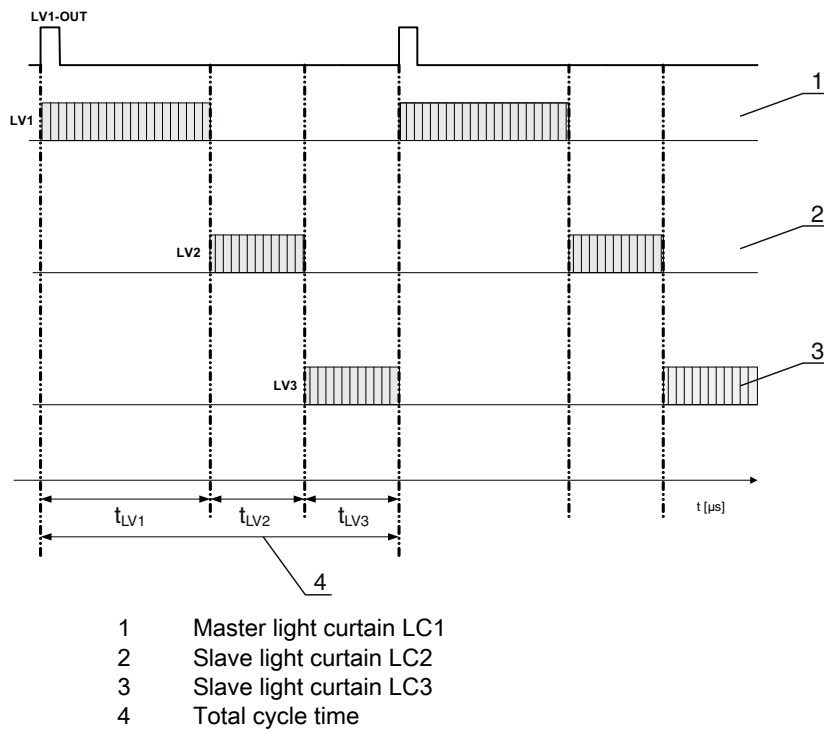

Figure 4.14: Example: cascading via internal trigger

4.10 Block evaluation of beam areas

With this function, the quantity of data to be transmitted can be reduced by restricting the imaging accuracy. The minimum resolution of the light curtain is still retained.

4.10.1 Defining beam area

To read out the beam states block-wisely with a 16-bit or 32-bit telegram, the individual beams can be mapped to up to 32 areas independent of the maximum beam number. The individual beam information of grouped beams is linked to a logical bit, i.e., each area is represented as 1 bit.

The number of beams in an area can be freely defined. However, the beams must be adjacent to one another. The start beam and the end beam are to be defined as well as the conditions for switching of the area.

NOTICE

Hold function for beam areas!

The hold function (see chapter 4.5) also applies for the block evaluation of beam areas.

4.10.2 Autosplitting

The beams of the device are automatically divided into the selected number of areas of the same size. The states of the areas generated in this way can be read out in the process data by means of the "Area Out - HiWord" and "Area Out - LoWord" parameters.

Procedure:

- Select logic combination of the beams within the areas (logical AND / logical OR)
- Define the number of desired areas (e.g., 16 or 32)



The autosplitting configuration can be defined via the respective fieldbus interface (see chapter 10 et seq.) or via the *Sensor Studio* configuration software (see chapter 15).

4.10.3 Mapping beam area to switching output

If grouping individual beams or if creating a block, the beam state of any number of adjacent beams (area) can be signaled at a switching output.

The following options are possible here:

- To use a specific, single beam for the evaluation, e.g., as trigger signal for a primary control.
- To group the complete measurement field into one switching area and thereby signal at the switching output whether an object (at any position) is located in the measurement field.
- To configure up to 32 switching areas for a reference check or height monitoring; in many cases, this can make beam-data processing in the primary programmable logic control (PLC) unnecessary.

The switching conditions for the areas can be either AND or OR linked:

Logic function	Group bit (area status) [logic 1/0]	
	AND	1
0		if at least one beam is not interrupted in the selected area
OR	1	if at least one beam is interrupted in the selected area
	0	if none of the beams mapped to the area are interrupted

Areas may be sequential or overlapping. A maximum of 32 areas are available.



The switching behavior or the conditions for switching a beam area on and off can be defined via the respective fieldbus interface (see chapter 10 et seq.) or via the *Sensor Studio* configuration software (see chapter 15).

For an example configuration, see chapter 14.2.

Example for the configuration of an OR or AND link for a light curtain with 32 beams

	OR	AND
Start Beam	1	1
End Beam	32	32
Switch-on condition	1 beam interrupted	32 beams interrupted
Switch-off condition	0 beams interrupted	31 beams interrupted

The following figure shows how the beam areas can be arranged directly next to one another or freely overlapping.

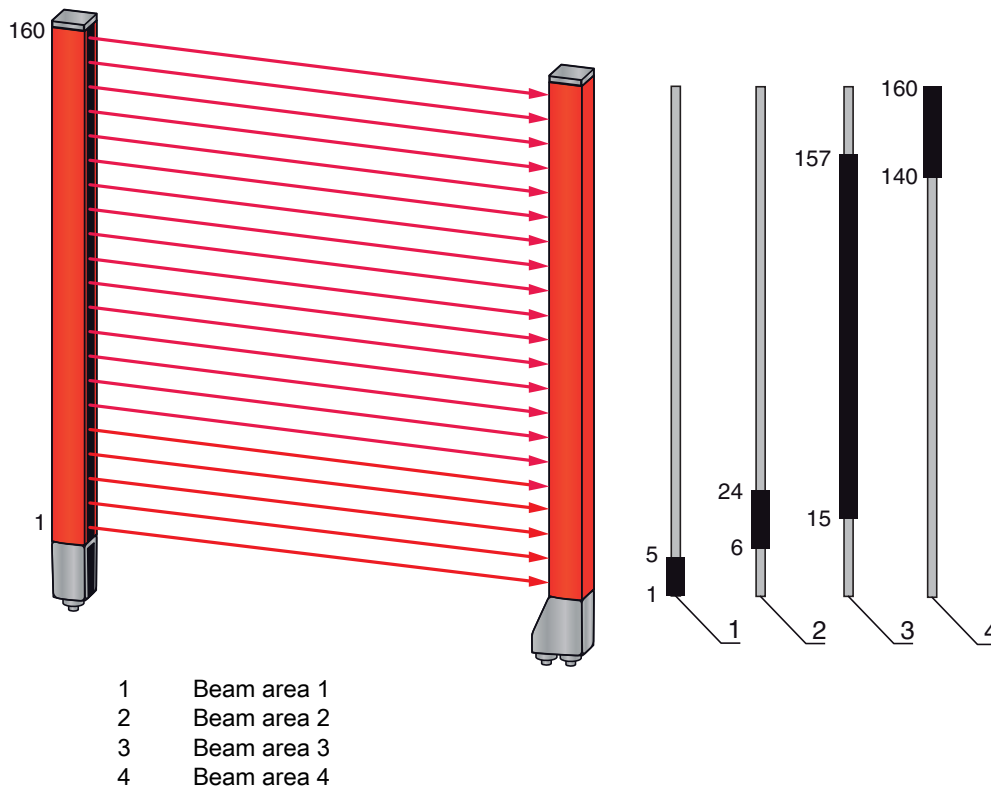

Figure 4.15: Beam areas

For a mapping of previously defined beam areas to, e.g., four switching outputs (Q1 to Q4), see chapter 14.2.

NOTICE

Increased number of logical beams for the diagonal- or crossed-beam function!

⚠ Take into account the (increased) number of beams if the “diagonal”- or “crossed-beam” mode is activated (see chapter 4.1.2 or see chapter 4.1.3).

4.10.4 Teach height area

With the “Teach height area” function, it is possible to teach in up to four height areas, e.g. for height monitoring or sorting packets. In many cases, this saves time for programming.

- A maximum of four height areas are available.
- A height area is automatically defined using an object.
 When teaching a height area, all free beams above or below the object are combined into one height area. Therefore, the object cannot be located in the center of the measurement field length; the first or last beam must be interrupted.

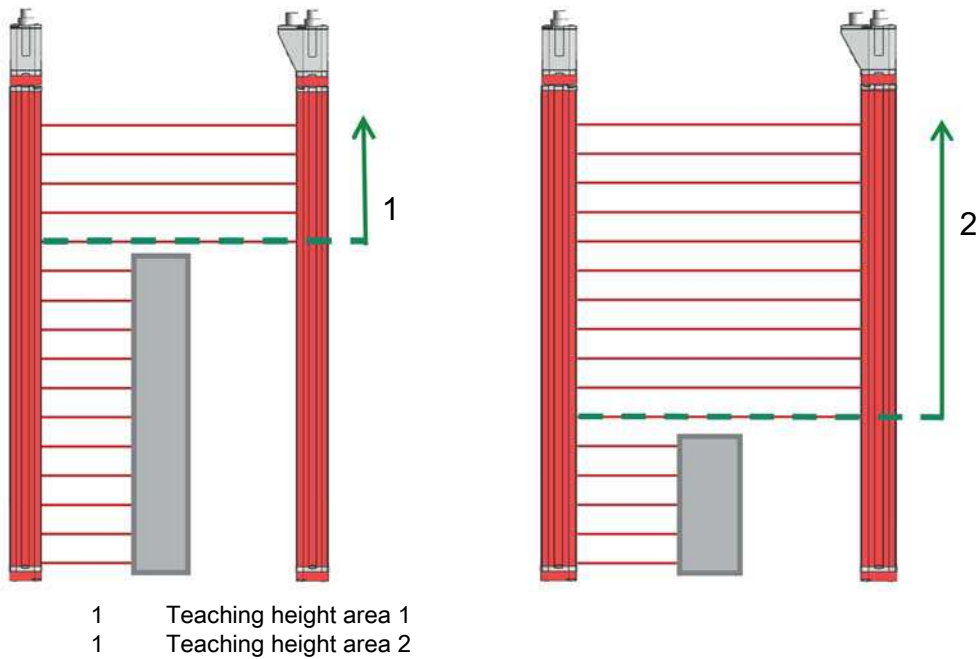

Figure 4.16: Teaching the height area with the “Teach in height area” function

- To define the entire beam area as a height area, teaching of the height area is performed without an object (all beams free).

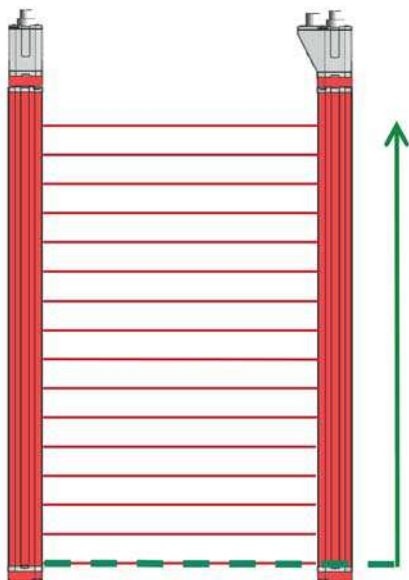

Figure 4.17: Teaching of the total beam area as height area without object

- The switching behavior or the conditions for switching the height area on or off via the “Teach height area” function is permanently defined as OR.
- Every IO pin can be assigned to a height area via the receiver control panel.
Example: **Digital IOs > IO Pin 2 > Teach height > Execute**



On the receiver control panel, the “Teach height area” function is activated via the **Teach height** menu item. Example: **Digital IOs > IO Pin 2 > Teach height > Execute**

If the “Teach height area” function is activated via the receiver control panel, the IO pins are automatically assigned to the height areas.

Example configurations for the assignment of previously defined height areas to switching outputs Q1 to Q4:

- see chapter 14.2 "Example configuration - Mapping of beams 1 ... 32 to output pin 2"

4.11 Switching outputs

4.11.1 Light/dark switching

The behavior of switching outputs Q1 to Q4 (or Q1 to Q2) can be configured with respect to light/dark switching. The setting `ex` works is "light switching", i.e., the outputs are activated if the light paths are free and become inactive if an object is detected in the measurement field.

 The output behavior can be changed to "dark switching" via the respective fieldbus interface (see chapter 10 et seq.), via the receiver control panel and via the *Sensor Studio* configuration software (see chapter 15).

4.11.2 Time functions

Each of the individual switching outputs can be assigned one of the time functions described in the following table.

 The accuracy of the switching delay is dependent on the measurement frequency. Observe this especially in cascaded operation.

Time function	Selectable duration	Description
Start-up delay with re-trigger	0 ... 65000 ms	Time that the sensor delays the start-up process after detecting an object. By means of a start-up delay, it is possible to suppress, e.g., upward-protruding packaging remnants (stretch wrap, etc.) during pallet height monitoring.
Switch-off delay with re-trigger	0 ... 65000 ms	Time that the sensor delays the switching back of the output if the object leaves the detection range.
Pulse stretching	0 ... 65000 ms	Minimum time that the state of the output is retained independent of what the sensor detects during this time. Pulse stretching is necessary for, e.g., hole recognition if the PLC cycle time does not register short pulses.
Pulse suppression with re-trigger	0 ... 65000 ms	Minimum time that a measurement signal must be present in order for the output to switch. Short interference pulses are thereby suppressed.

 The various time functions can be configured via the respective fieldbus interface (see chapter 10 et seq.) or via the *Sensor Studio* configuration software (see chapter 15).

4.12 Interference suppression (filter depth)

To suppress any faulty measurement values that may occur due to interference (ambient light, electromagnetic fields, ...), the filter depth of the light curtain can be increased.

"Filter depth" means that an interrupted/free beam is not included in the further data evaluation until the same beam status is recorded for the set number of measurement cycles.

Filter depth "1" = the beam states of each measurement cycle are output.

Filter depth "3" = only those beam states that were stable over three measurement cycles are output.

 Filter depth can be configured via the respective fieldbus interface (see chapter 10 et seq.) or via the *Sensor Studio* configuration software (see chapter 15).

5 Applications

The following typical applications with corresponding evaluation function (see chapter 4) exist for the measuring light curtain.

5.1 Height measurement



Figure 5.1: Height measurement

↪ Evaluation function: *Last interrupted beam (LIB)*.

5.2 Object measurement

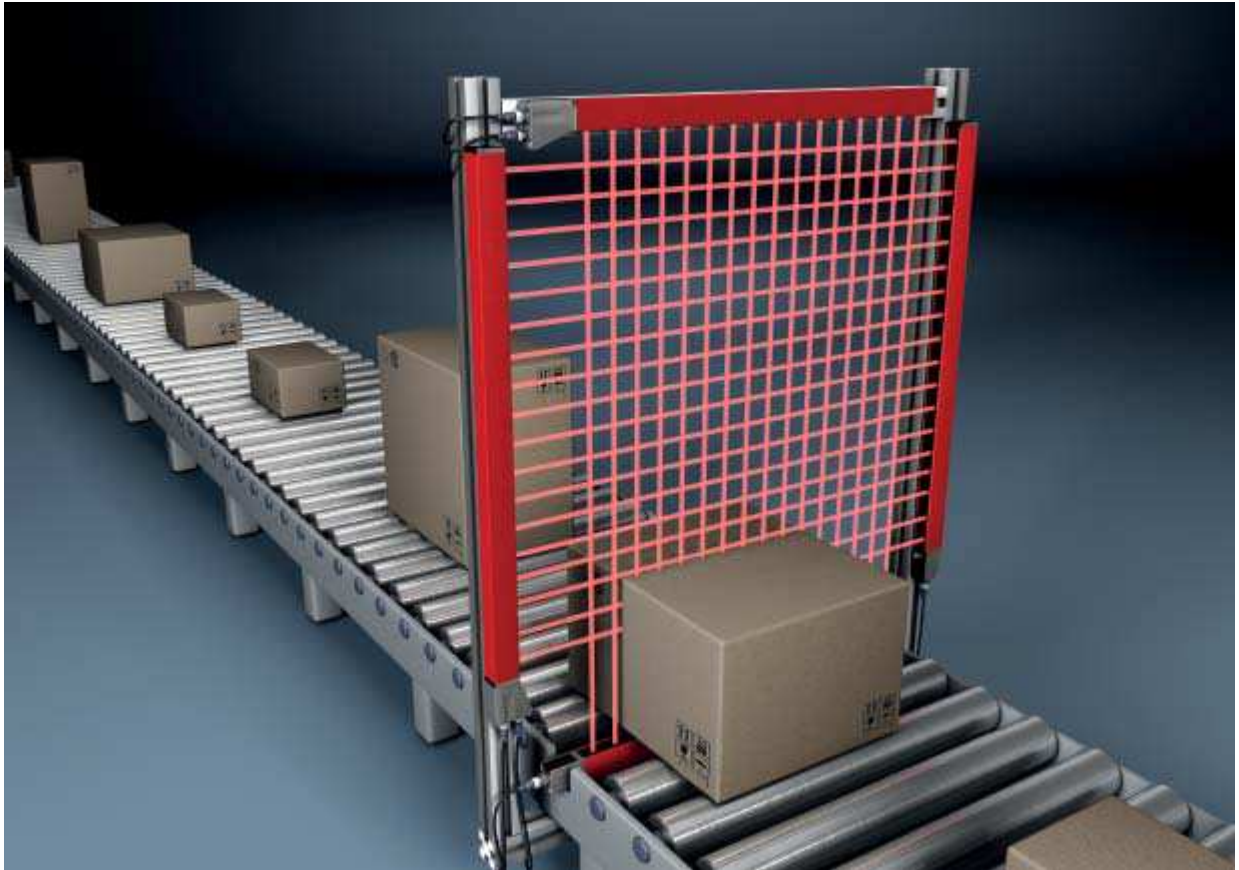

Figure 5.2: Object measurement

↵ Height evaluation function: *Last interrupted beam (LIB)*.

↵ Width evaluation function: *Number of all interrupted beams (TIB)*.

5.3 Width measurement, orientation detection



Figure 5.3: Width measurement, orientation detection

↪ Evaluation function for width measurement: *Number of all interrupted beams (TIB).*

↪ Evaluation function for orientation detection: *Single-beam evaluation (beam-stream) or first/last interrupted beam (FIB/LIB).*

5.4 Contour measurement

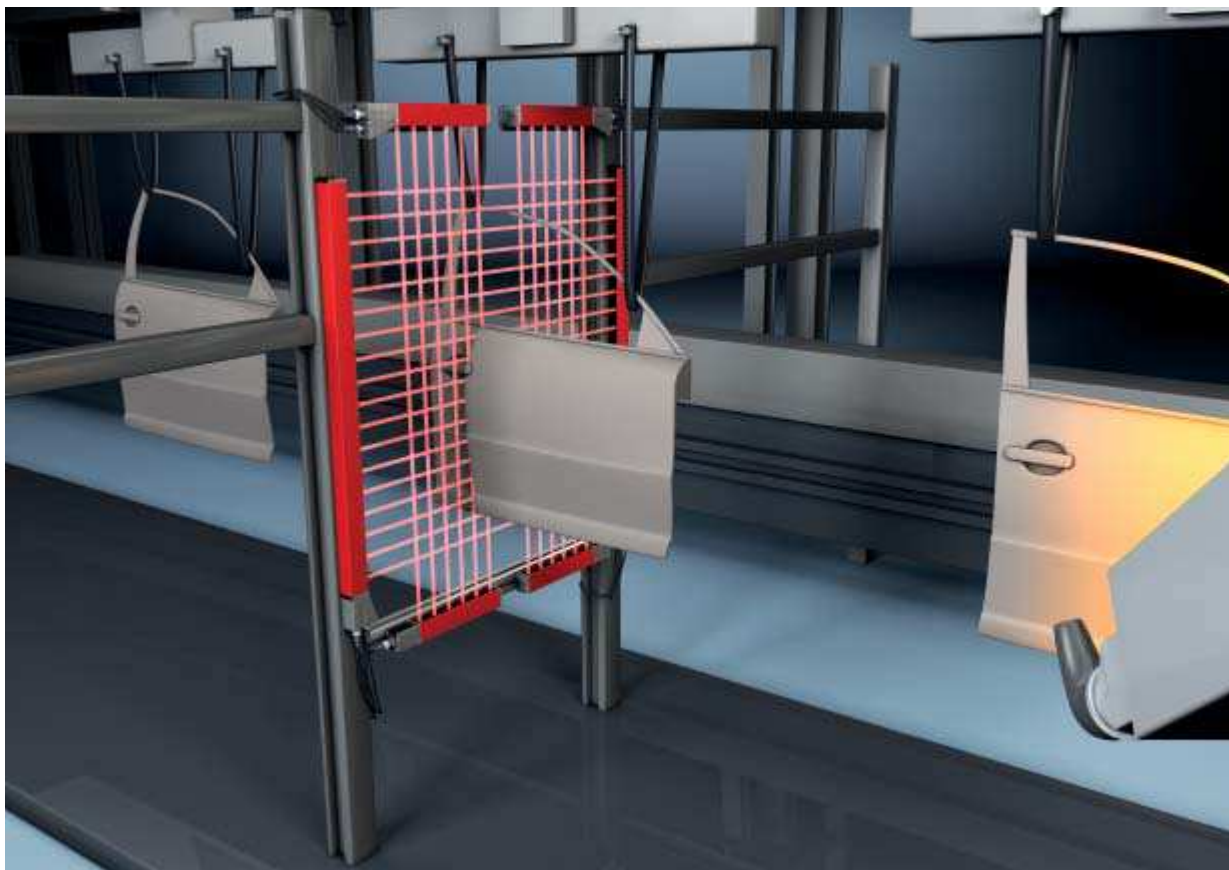

Figure 5.4: Contour measurement

↳ Evaluation function: *Single-beam evaluation (beam-stream)*.

5.5 Gap control/gap measurement

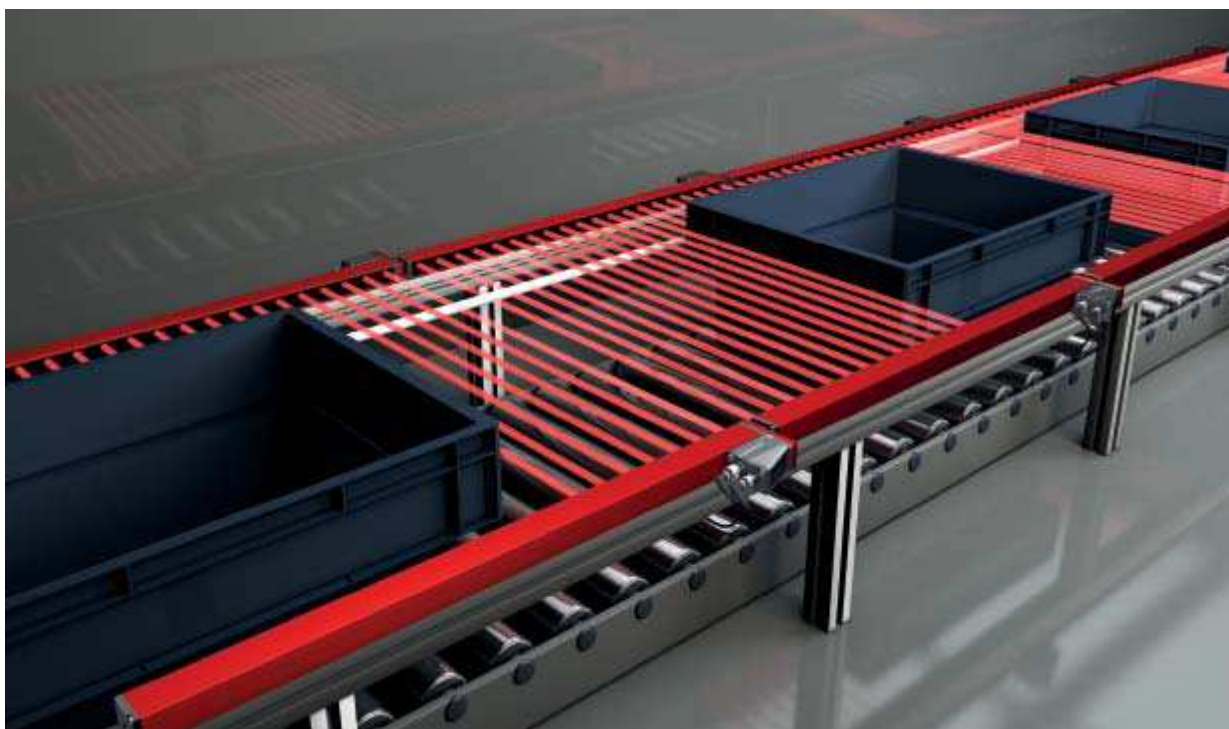

Figure 5.5: Gap control/gap measurement

↳ Evaluation function: *Single-beam evaluation (beam-stream)*.

5.6 Hole recognition

For a detailed configuration example see chapter 14.3.

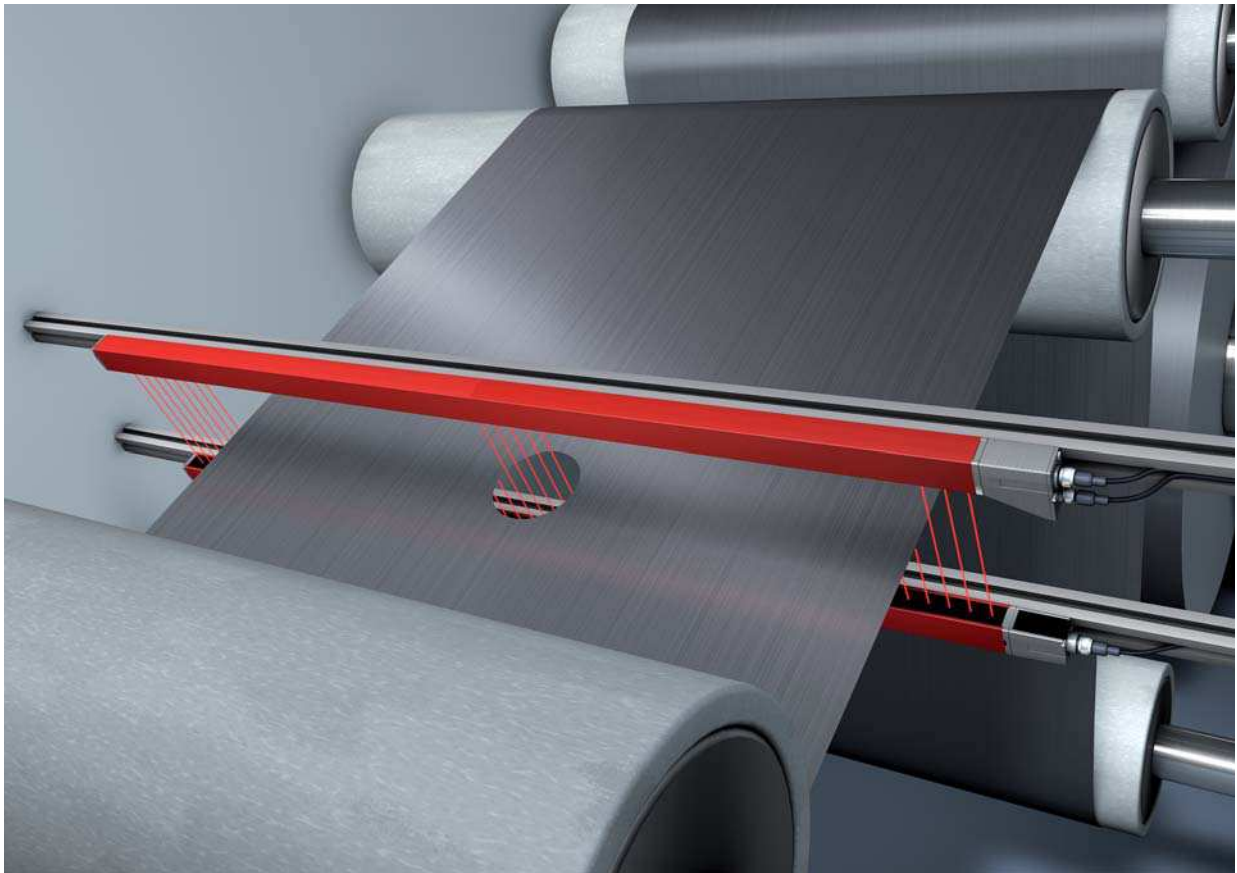

Figure 5.6: Hole recognition

- ↪ For hole recognition within a web material, a beam area must be defined over the area to be monitored and mapped to an output. All beams in this area are interrupted. If a beam becomes “free” due to a flaw in the material, the output switches.
- ↪ If, for example, the web edge wanders slightly, the beam area can be dynamically adapted by “tracking” the start beam by selecting the *First interrupted beam (FIB)* evaluation function and the end beam by selecting the *Last interrupted beam (LIB)* evaluation function.

6 Mounting and installation

6.1 Mounting the light curtain

NOTICE**No reflective surfaces, no mutual interference!**

- ↪ Avoid reflective surfaces near the light curtains.
Objects may otherwise not be precisely detected due to halation.
- ↪ Ensure sufficient distance, suitable positioning or partitioning.
Optical sensors (e.g., other light curtains, photoelectric sensors, etc.) must not interfere with one another.
- ↪ Avoid interference from outside light (e.g., from flash lamps, direct sunlight) on the receiver.

Mount the transmitter and receiver as follows:

- ↪ Select the fastening type for transmitter and receiver.
 - Fastening via the T-groove on one side of the standard profile (see chapter 6.3).
 - Fastening via the rotating bracket on the ends of the profile (see chapter 6.4).
 - Fastening via the swiveling mounting brackets or parallel brackets (see chapter 6.5).
- ↪ Have a suitable tool at hand and mount the light curtain in accordance with the notices regarding the mounting locations.
- ↪ Mount the transmitter and receiver at the same height or with the same housing reference edge, free of tension and with the base in full contact with the mounting surface.

NOTICE**Must be observed!**

- ↪ For horizontally mounted measuring light curtains with lengths of more than 2,000 mm, use an additional mounting bracket in the middle of the light curtain.
- ↪ The optical surfaces of transmitter and receiver must be parallel to and opposite one another.
- ↪ The transmitter and receiver connections must point in the same direction.

- ↪ Secure transmitter and receiver against turning or sliding.

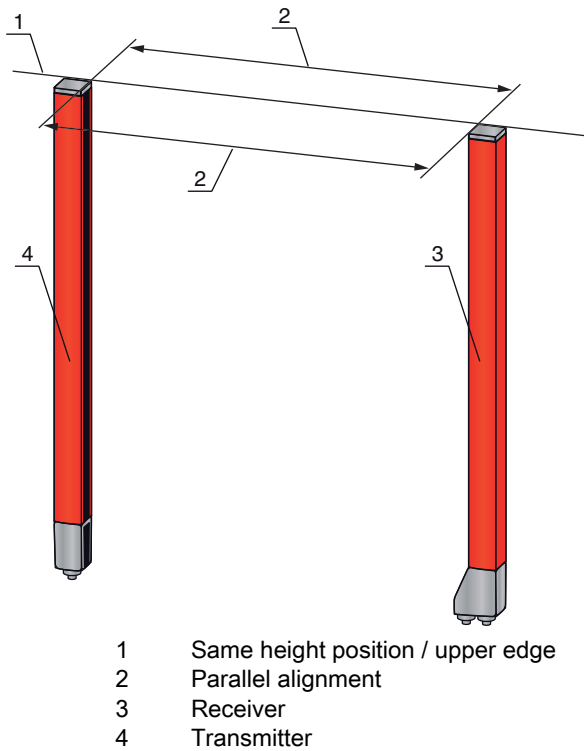

Figure 6.1: Arrangement of transmitter and receiver

i To achieve the maximum operating range limit, transmitter and receiver must be aligned with one another as accurately as possible.

After mounting, you can electrically connect (see chapter 7) and start up (see chapter 8) the light curtain.

6.2 Definition of directions of movement

The following terms for alignment movements of the light curtain around one of its individual beams are used:

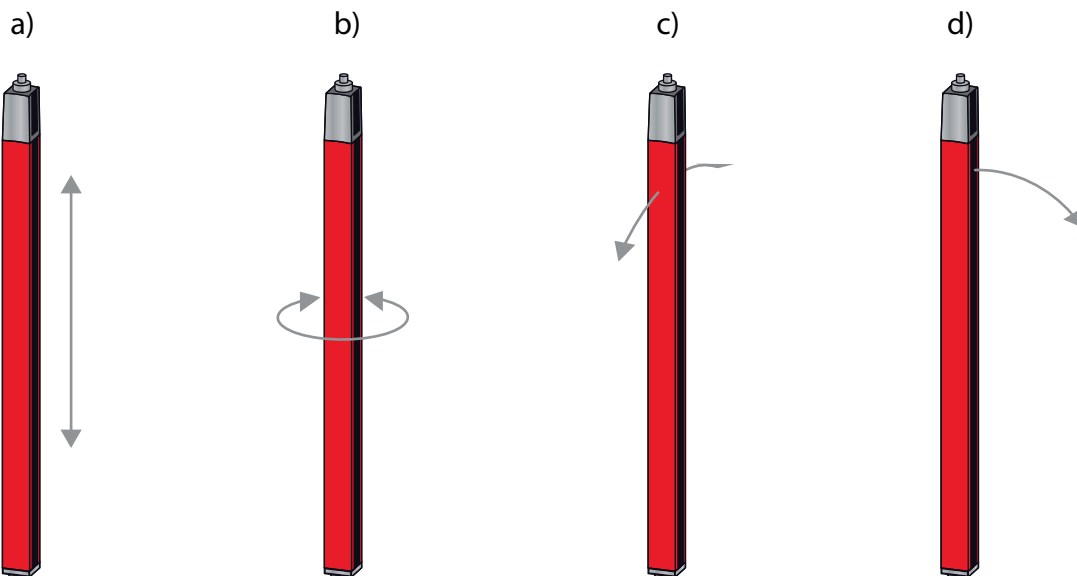

- a Sliding: movement along the longitudinal axis
- b Turning: movement around the longitudinal axis
- c Tilting: lateral turning movement diagonal to the lens cover
- d Pitching: lateral turning movement in the direction of the lens cover

Figure 6.2: Directions of movement during alignment of the light curtain

6.3 Fastening via sliding blocks

By default, transmitter and receiver are delivered with two sliding blocks (three sliding blocks for measurement field lengths of more than 2,000 mm) each in the side groove (see chapter 20).

↪ Fasten transmitter and receiver to the machine or system via the lateral T-groove with M6 screws.



Sliding in the direction of the groove is possible, but turning, tilting and pitching is not.

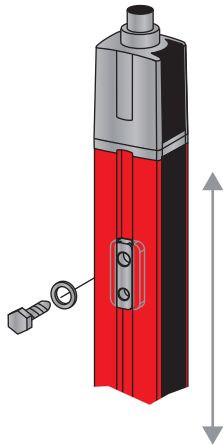

Figure 6.3: Mounting via sliding blocks

6.4 Fastening via swivel mount

When mounting with the BT-2R1 swivel mount (see table 20.21), sold separately, the light curtain can be aligned as follows:

- Sliding through the vertical threaded holes in the wall plate of the swivel mount
- Turning by 360° around the longitudinal axis by fixing on the screw-on cone
- Tilting around main axis
- Pitching through horizontal threaded holes in the wall mounting

The wall mounting through threaded holes makes it possible to lift the mounting bracket after the screws have been loosened over the connection cap. Therefore, the mounting brackets do not need to be removed from the wall when exchanging the device. Loosening the screws is sufficient.

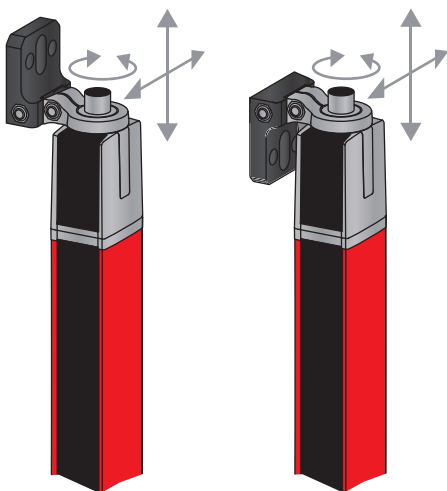

Figure 6.4: Mounting via swivel mount



Devices with rear connector outlet require an additional cylinder and screw for mounting with the BT-2R1 swivel mount. These extra parts are included in the scope of delivery of the device.

One-sided mounting on the machine table

The sensor can be mounted directly on the machine table via an M5 screw on the blind hole in the end cap. On the other end, a BT-2R1 swivel mount can be used, for example, so that turning movements for alignment are possible despite the fact that the sensor is mounted on one side.

NOTICE

Avoid reflection bypasses at the machine table!

↪ Make sure that reflections on the machine table and in the vicinity are prevented reliably.

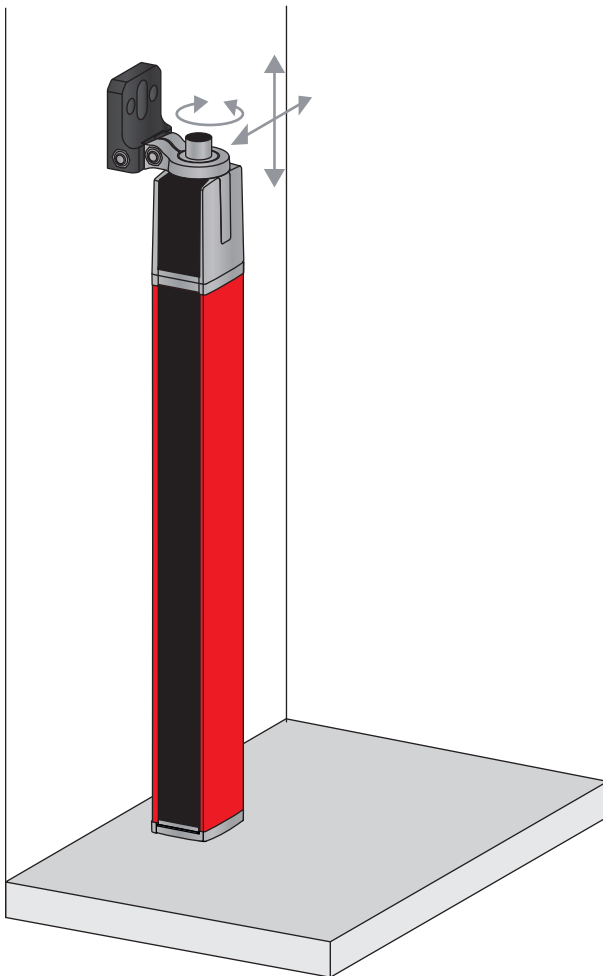

Figure 6.5: Mounting directly on the machine table

6.5 Fastening via swiveling mounting brackets

When mounting with the BT-2SSD/BT-4SSD or BT-2SSD-270 swiveling mounting brackets (see table 20.21), sold separately, the light curtain can be aligned as follows:

- Sliding in the direction of slot
- Turning +/- 8° around the longitudinal axis

The BT-SSD (see figure 19.5) swiveling mounting brackets are also equipped with a vibration damper.

7 Electrical connection

7.1 Shielding and line lengths

The light curtains are equipped with modern electronics developed for industrial applications. In industrial environments, a number of sources of interference may affect the light curtains.

In the following, information is provided on the EMC-compliant wiring of the light curtains and the other components in the switch cabinet.

7.1.1 Shielding

NOTICE
<p>General shielding information!</p> <p>↳ Avoid interference emissions when using power components (frequency inverters, ...).</p> <p>The necessary specifications under which the power component satisfies its CE Declaration of Conformity can be found in the technical descriptions of the power components.</p> <p>In practice, the following measures have proven effective:</p> <p>Properly ground the total system.</p> <p>Screw mains filter, frequency inverter, etc., flat to a galvanized mounting plate (thickness 3 mm) in the switch cabinet.</p> <p>Keep cable between mains filter and inverter as short as possible and twist cables.</p> <p>Shield both ends of the motor cable.</p> <p>↳ Carefully ground all parts of the machine and of the switch cabinet using copper strips, ground rails or grounding cables with large cross section.</p> <p>↳ Keep the length of the shieldless end of the cable as short as possible.</p> <p>↳ Guide the shielding untwisted to a terminal (no "RF braid").</p>

NOTICE
<p>Separate power and control cables!</p> <p>↳ Lay the cables for the power components (mains filter, frequency inverter, ...) as far from the light curtain cables as possible (distance > 30 cm).</p> <p>↳ Avoid laying power and light curtain cables parallel to one another.</p> <p>↳ Cable crossings should be laid as perpendicular as possible.</p>

NOTICE
<p>Lay cables close to grounded metal surfaces!</p> <p>↳ Lay the cables on grounded metal surfaces</p> <p>This measure reduces interference coupling in the cables.</p>

NOTICE
<p>Avoid leakage currents in the cable shielding!</p> <p>↳ Carefully ground all parts of the machine.</p> <p>Leakage currents arise from incorrectly implemented equipotential bonding.</p> <p>You can measure leakage currents with a clip-on ammeter.</p>

NOTICE
<p>Star-shaped cable connections!</p> <p>↳ Ensure that the devices are connected in a star-shaped arrangement.</p> <p>You thereby avoid mutual influences from various loads.</p> <p>This prevents cable loops.</p>

Grounding the light curtain housings

- ↪ Connect the transmitter housing **and** receiver housing of the light curtain to the protective conductor on the FE machine star point via the PE screw on the grounding slot nut (see figure 7.1).
The cable should have an impedance as low as possible for high-frequency signals, i.e., be as short as possible and have a large cross-sectional area (grounding strip, ...).
- ↪ Use a lock washer and check the penetration of the anodized layer.
- ↪ Check the small Allen screw to ensure a secure connection between the grounding slot nut and housing.
The Allen screw is correctly tightened upon delivery from the factory.
If you have changed the position of the grounding slot nut or the PE screw, tighten the small Allen screw.

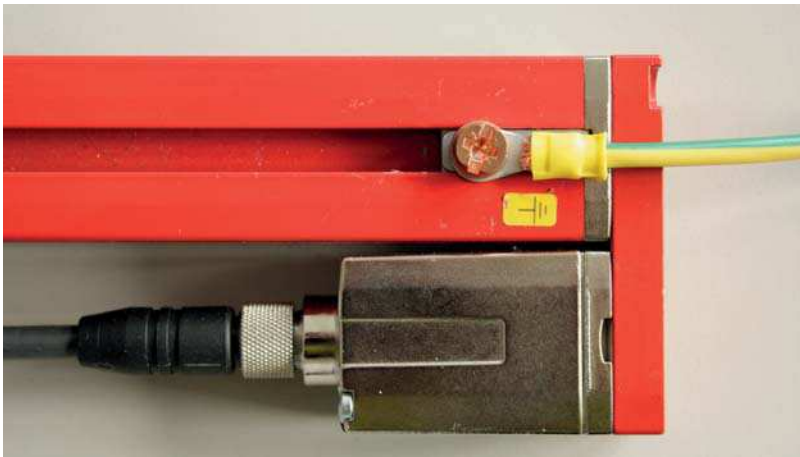

Figure 7.1: Connecting the ground potential to the light curtain

Example for shielding both ends of the connection cables from the switch cabinet to the light curtain

- ↪ Ground the transmitter housing and receiver housing of the light curtain (see chapter "Grounding the light curtain housings").
- ↪ Clamp the shield in the switch cabinet flat to FE (see figure 7.2).
Use special shielding terminals (e.g., Wago, Weidmüller, ...).

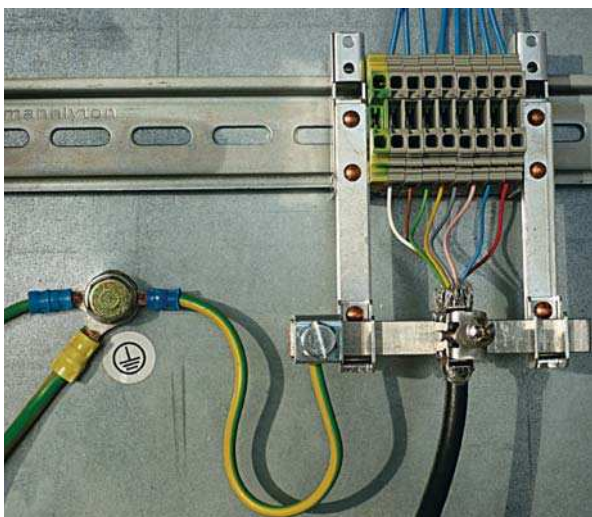

Figure 7.2: Connecting the cable shielding in the switch cabinet

Depicted shielding components from Wago, series 790 ...:

- 790 ... 108 screen clamping saddle 11 mm
- 790 ... 300 busbar holder for TS35

Example for shielding both ends of the connection cables from the PLC to the light curtain

- ↪ Ground the transmitter housing and receiver housing of the light curtain (see chapter "Grounding the light curtain housings").
- ↪ Only lay shielded light curtain cables to the PLC.
- ↪ Clamp the shield flat to FE in the PLC (see figure 7.3).
Use special shielding terminals (e.g., Wago, Weidmüller, ...).
- ↪ Make certain that the mounting rail is well grounded.

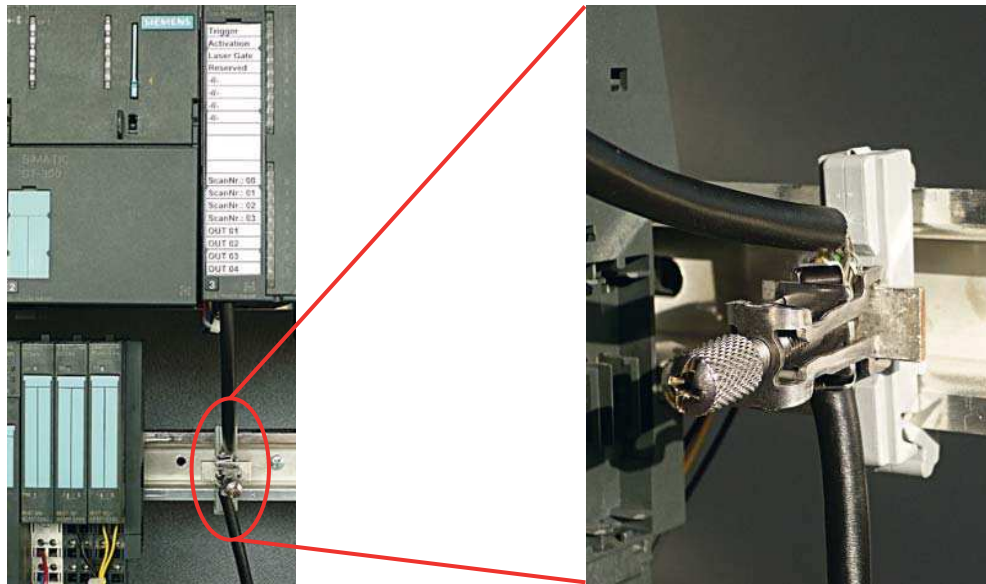

Figure 7.3: Connecting the cable shielding to the PLC

Depicted shielding components from Wago, series 790 ...:

- 790 ... 108 screen clamping saddle 11 mm
- 790 ... 112 carrier with grounding foot for TS35

7.1.2 Cable lengths for shielded cables

- ↪ Observe the maximum cable lengths for shielded cables.

Table 7.1: Cable lengths for shielded cables

Connection to the CML 700i	Interface	Max. cable length	Shielding
PWR IN/digital IO, IO-Link, analog	X1	20 m	required
PWR IN/digital IO (Y-connection cable and synchronization cable)	X1	20 m	not required
Synchronization cable analog/IO-Link	X2/X3	20 m	required
BUS IN /BUS OUT (Y-fieldbus cable)	X2	40 m	required

Designation of the interface connections: see chapter 7.3 "Device connections"

7.2 Connection and interconnection cables

Use only the cables listed in the accessories (see chapter 20) for all connections (connection cable, analog/IO-Link/fieldbus interconnection cable, cable between transmitter and receiver).

Use only shielded cables for the cable between transmitter and receiver.

NOTICE
Competent persons and approved purpose!
<ul style="list-style-type: none"> ☞ Only allow competent persons to perform the electrical connection. ☞ Select the functions so that the light curtain can be used as intended (see chapter 2.1).

7.3 Device connections

The light curtain is provided with the following connections:

Device connection	Type	Function
X1 on receiver	M12 connector, 8-pin	Control interface and data interface: <ul style="list-style-type: none"> • Voltage supply • Switching outputs and control inputs • Configuration interface • Synchronization interface (for devices with fieldbus interface)
X2 on receiver	M12 socket, 5-pin	Synchronization interface and fieldbus interface: <ul style="list-style-type: none"> • Synchronization interface (for devices with analog output or IO-Link interface) • Fieldbus interface (for CANopen/Profibus/RS 485 Modbus devices)
X3 on transmitter	M12 connector, 5-pin	Synchronization interface (for all controller types)

7.4 Digital inputs/outputs on connection X1

Ex works, input/output IO 1 (pin 2) is assigned the teach-in function and input/output IO 2 (pin 5) is assigned the trigger-in function.

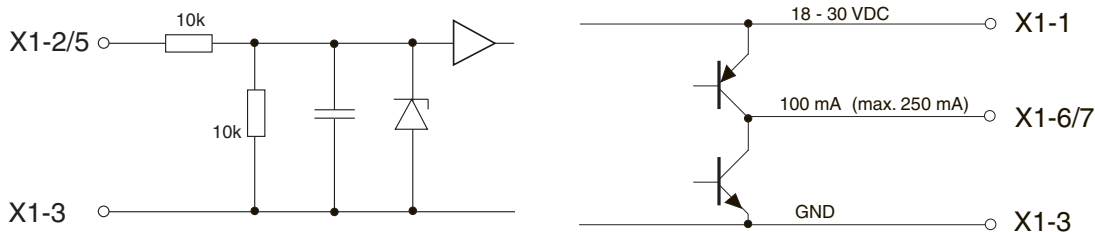

Figure 7.4: Digital input/output schematic diagram

NOTICE
Single assignment of input functions!
<ul style="list-style-type: none"> ☞ Each input function may only be used one time. If multiple inputs are assigned the same function, malfunctions may occur.

7.5 Electrical connection – CML 700i with IO-Link/analog interface

The electrical connection of devices with IO-Link and analog interfaces is established in the same way.

NOTICE

Light curtain grounding!

⚡ Ground the light curtain before establishing an electrical connection or connecting the voltage supply (see chapter "Grounding the light curtain housings").

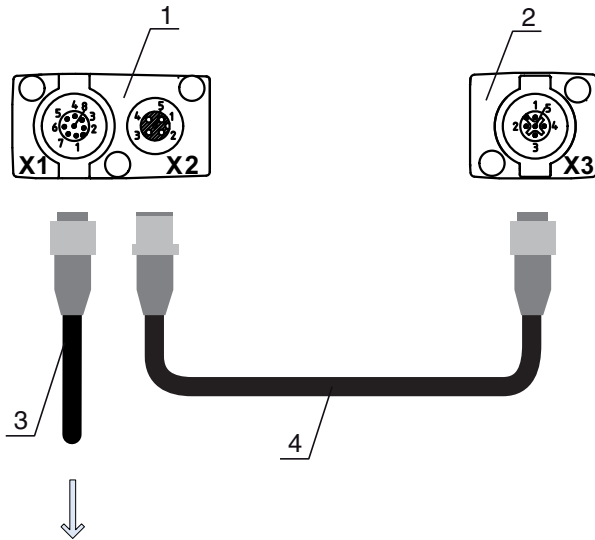

PWR IN/OUT

- 1 Receiver (R)
- 2 Transmitter (T)
- 3 Connection cable (M12 socket, 8-pin), see table 20.3
- 4 Synchronization cable (M12 plug/socket, 5-pin), see table 20.4

Figure 7.5: Electrical connection – CML 700i with IO-Link/analog interface

- ⚡ Connect connection X2 to connection X3 using the appropriate synchronization cable.
- ⚡ Connect connection X1 to the power supply and the control using the appropriate connection cable.

7.5.1 X1 pin assignment – CML 700i with IO-Link interface

8-pin, M12 plug (A-coded) for connecting to PWR IN/digital IO and IO-Link interface.

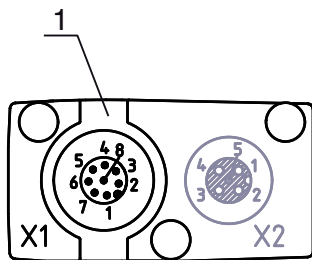

- 1 M12 plug (8-pin, A-coded)

Figure 7.6: Connection X1 – CML 700i with IO-Link interface

Table 7.2: X1 pin assignment – CML 700i with IO-Link interface

Pin	X1 - Logic and power on the receiver
1	VIN: +24 V DC supply voltage
2	IO 1: input/output (configurable) Ex works: teach input (Teach In)
3	GND: ground (0 V)

Pin	X1 - Logic and power on the receiver
4	C/Q: IO-Link communication
5	IO 2: input/output (configurable) Ex works: trigger input (Trigger-In)
6	IO 3: input/output (configurable)
7	IO 4: input/output (configurable)
8	GND: ground (0 V)

Connection cables: see table 20.3.

7.5.2 X1 pin assignment – CML 700i with analog interface

8-pin, M12 plug (A-coded) is used for connecting to PWR IN/digital IO and analog interface.

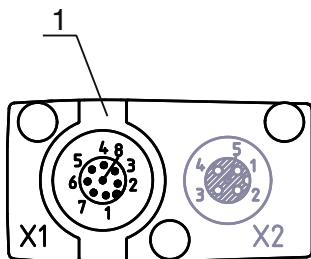

1 M12 plug (8-pin, A-coded)

Figure 7.7: Connection X1 – CML 700i with analog interface

Table 7.3: X1 pin assignment – CML 700i with analog interface

Pin	X1 - Logic and power on the receiver
1	VIN: +24 V DC supply voltage
2	IO 1: input/output (configurable) Ex works: teach input
3	GND: ground (0 V)
4	C/Q: IO-Link communication
5	IO 2: input/output (configurable) Ex works: trigger input
6	0 ... 10 V: analog voltage output
7	4 ... 20 mA: analog current output
8	AGND: analog output reference potential

Connection cables: see table 20.3.

<p>NOTICE</p> <p>Select either voltage output (pin 6) or current output (pin 7)!</p> <p>⚡ Voltage output and current output (pin 6 and pin 7) are not available simultaneously. The type of analog signal must be selected via the receiver control panel (see chapter 9). Alternatively, the analog signal can be configured via the <i>Sensor Studio</i> configuration software (see chapter 15).</p>

NOTICE

Signal crosstalk in analog operation during simultaneous IO-Link communication!
 If the simultaneous operation of IO-Link and analog signals is desired, perform the following measures:

- ↳ Wire a filter to the analog input of the control.
- ↳ Use shielded cables for the analog lines.

NOTICE

Permissible load resistance on the analog output!
 When connecting the analog output, note the permissible load resistance.

- ↳ Voltage output 0 ... 10 V DC / 0 ... 11 V DC: $R_L \geq 2 \text{ k}\Omega$
- ↳ Current output 4 ... 20 mA DC / 0 ... 24 mA DC: $R_L \leq 500 \Omega$

7.5.3 X2/X3 pin assignment – CML 700i with IO-Link/analog interface

5-pin, M12 socket/plug (A-coded) for the connection between transmitter and receiver.

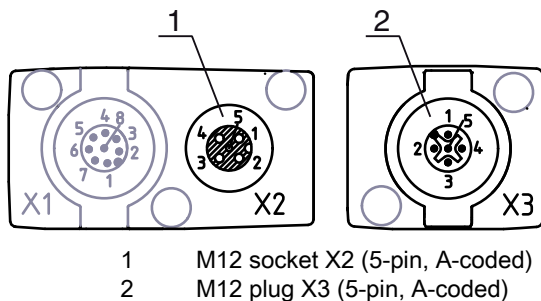

Figure 7.8: Connection X2/X3 – CML 700i with IO-Link/analog interface

Table 7.4: X2/X3 pin assignment – CML 700i with IO-Link/analog interface

Pin	X2/X3 - Transmitter and receiver
1	SHD: FE functional earth, shield
2	VIN: +24 V DC supply voltage
3	GND: ground (0 V)
4	RS 485 Tx+: synchronization
5	RS 485 Tx-: synchronization

Interconnection cables: see table 20.4.

7.6 Electrical connection – CML 700i with fieldbus interface

The electrical connection is established in the same way for all devices with fieldbus interfaces (CANopen, Profibus or RS 485 Modbus interface).

NOTICE

Light curtain grounding!
 ↳ Ground the light curtain before establishing an electrical connection or connecting the voltage supply (see chapter "Grounding the light curtain housings").

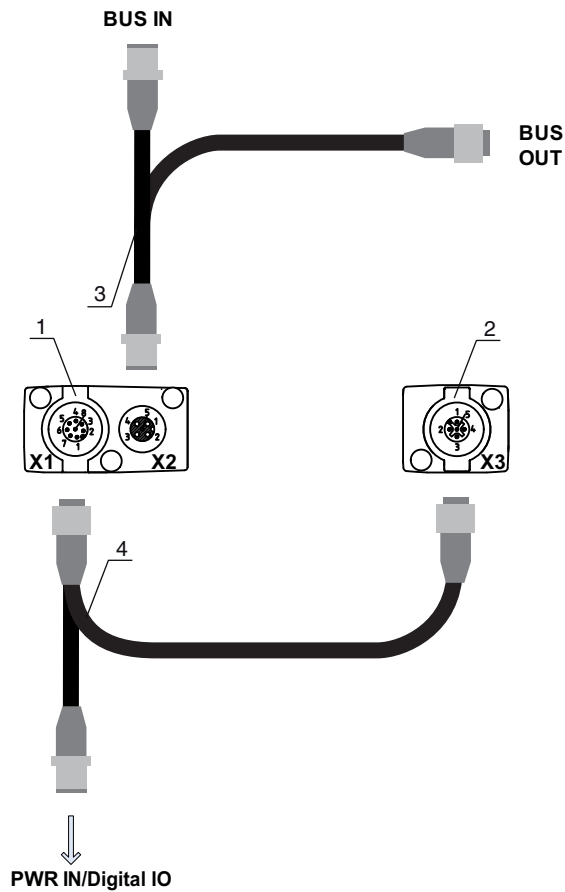

- 1 Receiver (R)
- 2 Transmitter (T)
- 3 Y-fieldbus cable (M12 plug/socket, 5-pin), see table 20.11, see table 20.13
- 4 Y-connection cable and synchronization cable (M12 socket/plug, 8-pin/5-pin), see table 20.7

Figure 7.9: Electrical connection – CML 700i with CANOpen, Profibus or RS 485 Modbus interface

- ↪ Connect connection X2 on the receiver with the Y-interconnection cable; use both ends to connect to BUS IN or BUS OUT on the other network devices.
- ↪ Connect connection X1 with the Y-interconnection cable; connect the short end to the power supply or configuration software interface and connect the long end to connection X3 on the transmitter.

7.6.1 Pin assignment – CML 700i with fieldbus interface

X1 pin assignment (logic and power on the receiver and connection to transmitter)

8-pin, M12 plug (A-coded) for connecting to PWR IN/digital IO and transmitter.

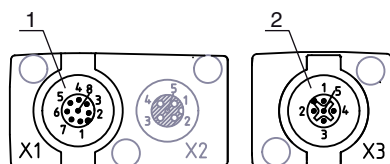

- 1 M12 plug (8-pin, A-coded)
- 2 M12 plug (5-pin, A-coded)

Figure 7.10: X1/X3 connection – CML 700i with CANOpen, Profibus or RS 485 Modbus interface

Table 7.5: X1/X3 pin assignment – CML 700i with CANopen, Profibus or RS 485 Modbus interface

Pin (X1)	X1 - Logic and power on the receiver and connection to transmitter	Pin (X3)
1	VIN: +24 V DC supply voltage	2
2	IO 1: input/output (configurable)	
3	GND: ground (0 V)	3
4	C/Q: IO-Link communication	
5	IO 2: input/output (configurable)	
6	RS 485 Tx-: synchronization	5
7	RS 485 Tx+: synchronization	4
8	SHD: FE functional earth, shield	1

Connection cables: see table 20.7

Pin assignment on the short end of the Y-interconnection cable (PWR IN/digital IO)

5-pin, M12 plug (A-coded) on the short end of the Y-interconnection cable for connecting to PWR IN/digital IO.

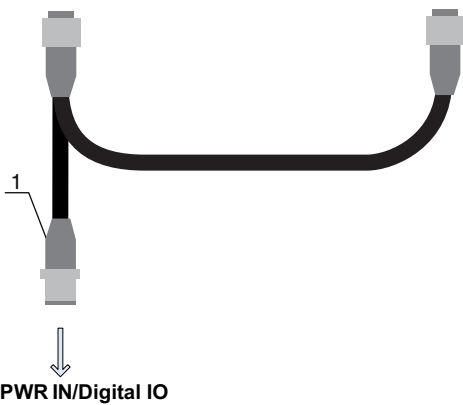

1 M12 plug (5-pin, A-coded)

Figure 7.11: Connection X1 - PWR IN/digital IO

Table 7.6: X1 pin assignment - PWR IN/digital IO

Pin	X1 - Short end of the Y-interconnection cable
1	VIN: +24 V DC supply voltage
2	IO 1: input/output (configurable) Ex works: teach input
3	GND: ground (0 V)
4	C/Q: IO-Link communication
5	IO 2: input/output (configurable) Ex works: trigger input

Connection cables: see table 20.8

Pin assignment on the long end of the Y-interconnection cable (PWR IN/digital IO)

The pin assignment on the long end of the Y-interconnection cable for synchronization of transmitter and receiver for devices with fieldbus interface is the same as for IO-Link/analog (see chapter 7.5.3).

X3 pin assignment (transmitter)

The pin assignment on the transmitter for devices with fieldbus interface is the same as for IO-Link/analog ; see chapter 7.5.3 and see table 7.5.

Connection cables: see table 20.7

7.6.2 X2 pin assignment – CML 700i with CANopen interface

5-pin, M12 plug (A-coded) for a device with CANopen interface for connecting to BUS IN/BUS OUT.

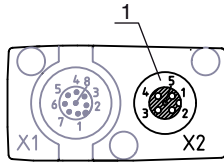

1 M12 socket (5-pin, A-coded)

Figure 7.12: Connection X2 – CML 700i with CANopen interface

Table 7.7: X2 pin assignment – CML 700i with CANopen interface

Pin	X2 - CANopen interface
1	SHD: FE functional earth, shield
2	n.c.
3	CAN_GND: ground (0 V)
4	CAN_H:
5	CAN_L:

Interconnection cables: see table 20.11.

7.6.3 X2 pin assignment – CML 700i with Profibus or RS 485 Modbus interface

5-pin, M12 plug (B-coded) for a device with Profibus or RS 485 Modbus interface for connecting to BUS IN/BUS OUT.

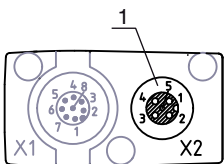

1 M12 socket (5-pin, B-coded)

Figure 7.13: X2 connection – CML 700i with Profibus or RS 485 Modbus interface

Table 7.8: X2 pin assignment – CML 700 i with Profibus or RS 485 Modbus interface

Pin	X2 - Profibus/RS 485 Modbus interface
1	VP: +5 V for bus termination
2	PB_A: receive/transmit data, A-cable (Tx-)
3	PB_GND: ground (0 V)
4	PB_B (P): receive/transmit data, B-cable (Tx+)
5	SHD: FE functional earth, shield

Connection cables: see table 20.13.

Profibus termination: see table 20.17 and see table 20.19.

7.7 Electrical supply

With regard to the data for the electrical supply, see table 19.6.

8 Starting up the device - Basic configuration

The basic configuration includes the alignment of transmitter and receiver and the basic configuration steps via the receiver control panel.

The following optional basic functions are available for operation and configuration via the receiver control panel:

- Define digital inputs/outputs
- Defining the filter depth
- Defining the display properties
- Changing the language
- Product information
- Resetting to factory settings

8.1 Aligning transmitter and receiver

NOTICE

Alignment during commissioning!

- ↪ The alignment performed during commissioning should only be performed by qualified personnel.
- ↪ Observe the data sheets and mounting instructions of the individual components.

Prerequisites:

- The light curtain has been mounted (see chapter 6) and connected (see chapter 7) correctly.

↪ Switch on the light curtain.

NOTICE

Alignment mode!

- ↪ When switched on for the first time ex works, the light curtain automatically starts in process mode.
- ↪ You can switch from process mode to alignment mode via the control panel.

↪ Check whether the green LEDs on the receiver control panel and transmitter illuminate continuously.

The display shows the alignment state of the first beam (FB) and last beam (LB) via two bar graph indicators.



Figure 8.1: Example: display showing an incorrectly aligned light curtain

↪ Loosen the fastening screws of the transmitter and receiver.

Loosen the screws only enough so that the devices can just be moved.

↪ Turn or slide the transmitter and receiver until the optimum position is reached and the bar graph indicators show the maximum values for the alignment.

NOTICE

Minimum sensitivity of the sensor!

- ↪ In order to perform a teach, a minimum level must be reached in the bar graph indicator (mark in the middle of the display).



Figure 8.2: Display showing an optimally aligned light curtain

↳ Tighten the fastening screws of the transmitter and receiver.
 Transmitter and receiver are aligned.

Switching to process mode

After aligning, switch to process mode.

↳ Select **Display > Mode > Process mode**.

The display in the receiver of the light curtain shows the process mode states with the number of all interrupted beams (TIB) and the logic states of the digital inputs/outputs (digital IOs).



Figure 8.3: Display showing the process mode state of the light curtain

The structure of the configuration in the receiver control panel menu is as follows:

Level 0	Level 1	Level 2	Description
Display	Language	English German French Spanish Italian	
	Mode	Process mode Alignment	

Switching to alignment mode

You can switch from process mode to alignment mode via the menu.

↳ Select **Display > Mode > Alignment**.

The structure of the configuration in the receiver control panel menu is as follows:

Level 0	Level 1	Level 2	Description
Display	Language	English German French Spanish Italian	
	Mode	Process mode Alignment	

The next configuration step is teaching the environmental conditions (teach).

8.2 Teaching the environmental conditions

During teaching, the system checks whether the signals of all beams are within a certain corridor. This means that a teach event generally regulates all beams to the preset function reserve (or sensitivity) for the current operating range. This ensures that all beams exhibit an identical switching behavior.

NOTICE

Conditions for performing a teach!

- ↳ When teaching without preconfigured blanking areas, the light path must always be completely free. A teaching error will otherwise occur.
- ↳ In this case, remove the obstacles and repeat the teach.
- ↳ If the light path is partially interrupted by structural elements, the permanently interrupted beams can be suppressed by means of blanking (*auto blanking* function). Interrupted beams are “deactivated” in this case.
- ↳ To automatically suppress the affected beams during teaching, configure the number of blanking areas via the configuration software *Sensor Studio* (see chapter 15).

The configuration can be performed via the respective fieldbus interface (see chapter 10 et seq.) or via the *Sensor Studio* configuration software (see chapter 15).

You can choose whether the teach values are to be stored permanently or only temporarily (while the operating voltage is applied). The configuration ex works is for permanent (non-volatile) storage.

A teach event can be performed both directly from process mode as well as from alignment mode.

NOTICE

Execute teach after changing the beam mode!

- ↳ Always perform a teach after changing the beam mode (parallel-/diagonal-/crossed-beam scanning) as well.

Prerequisites:

- The light curtain must be correctly aligned (see chapter 8.1).
- The bar graph indicator must show a minimum level.
- ↳ You can use one of the following teach types:
 - Teach via receiver control panel (see chapter 8.2.1).
 - Teach via teach input (see chapter 8.2.2).
 - Teach via fieldbus interface (IO-Link, see chapter 10; CANopen, see chapter 11; Profibus, see chapter 12; RS 485 Modbus, see chapter 13).
 - Teach via *Sensor Studio* configuration software (see chapter 15).

8.2.1 Teach via receiver control panel

If blanking areas are configured via the configuration software interface, a teach event is performed that takes these blanking areas into account (blanking teach or auto blanking, see chapter 4.6).

During a blanking teach or auto blanking, an “additional distance” is always added to the beams detected as interrupted. Safer operation is thereby achieved, e.g., in the case of vibrating guides, etc., in the “blanked” area.

Optimization of the blanked beams is to be performed via a software interface configuration.

A maximum of four adjacent areas of suppressed beams (blanking areas) can be configured.

The structure of the configuration in the receiver control panel menu is as follows:

Level 0	Level 1	Level 2	Description
Main Settings	Command		Teach Reset Factory Settings

↪ Select **Main Settings > Command > Teach**.

↪ Press the **↵** button to execute the teach.

The display shows



If the teach was started while in process mode, the display returns to the process mode display after a successful teach (see chapter 8.1).

If the teach was started from alignment mode, the display returns to the bar graph indicator following a successful teach and shows the received signal level of the first beam (FB) and the last beam (LB) (see chapter 8.1).

If teach is successful, both bars display the maximum value.



Figure 8.4: Display after successful teach

If no bars are visible in the bar graph indicator for the first beam (FB) and the last beam (LB), an error has occurred. It is possible, e.g., that the reception signal is too low. You can correct errors according to the error list (see chapter 16).

Power-Up Teach

After applying operating voltage, the “Power-Up Teach” function performs a teach event.

The structure of the configuration in the receiver control panel menu is as follows:

Level 0	Level 1	Level 2	Description
Main Settings	Command		Teach Reset Factory Settings
	Operational setting		
		Filter Depth	
		Beam mode	
		Function reserve	
		Blanking Teach	
		Power-Up Teach	Inactive Active

↪ Select **Main Settings > Operation Settings > Power-Up Teach > Active**.

8.2.2 Teaching via a control signal from the control

Teach input (Teach In)

This input can be used to perform a teach following initial commissioning, change of the alignment or during operation. During this procedure, the transmitter and receiver adjust themselves to the maximum function reserve according to the distance.

To trigger a teach, a pulse must be applied on connection X1 on the receiver IO1 = pin 2 (factory setting) for longer than 20 ms ... but less than 80 ms.

Depending on the configuration (PNP or NPN), this corresponds to the following signal response:

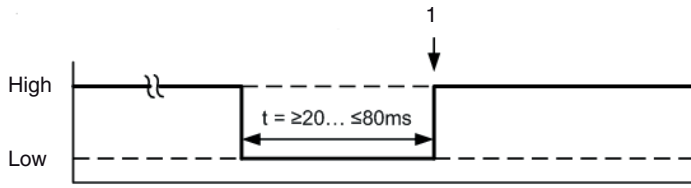

1 Teach is performed here

Figure 8.5: Control signals for line teach with PNP configuration

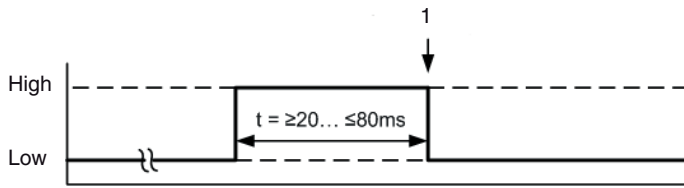

1 Teach is performed here

Figure 8.6: Control signals for line teach with NPN configuration

Performing a teach via the line input

Prerequisites:

- The light curtain must be correctly aligned (see chapter 8.1).
- A connection must be established between PLC and the line input (teach-in).

↪ Send a teach signal to the teach input via the control (see chapter "Teach input (Teach In)" for the data) to trigger a teach.

The display on the receiver control panel shows



Following a successful teach, the display switches back to the bar graph (alignment mode). If teach is successful, both bars display the maximum value.



Figure 8.7: Display after successful teach

The next configuration step is to check the alignment.

8.3 Check alignment

Prerequisites:

- The light curtain must first be correctly aligned and a teach must be performed.

↪ Check whether the green LEDs on the receiver control panel and transmitter illuminate continuously.

↪ Use the bar graph indicator to check whether the light curtain is optimally aligned, i.e., whether the maximum is reached for both the first beam (FB) and the last beam (LB) in the bar graph indicator.

↪ Use the bar graph indicator to check the optimum alignment of the light curtain if you have corrected an error that occurred.

The next configuration steps:

- Perform extended configurations on the receiver control panel if necessary (see chapter 8.5)
- Start up CML 700i light curtains with analog output (see chapter 9)
- Start up CML 700i light curtains with IO-Link interface (see chapter 10)
- Start up CML 700i light curtains with CANOpen interface (see chapter 11)
- Start up CML 700i light curtains with Profibus interface (see chapter 12)
- Start up CML 700i light curtains with RS 485 Modbus interface (see chapter 13)

8.4 Setting the function reserve

The function reserve can be set to four levels:

- High function reserve (low sensitivity)
- Medium function reserve
- Low function reserve (high sensitivity)
- Transparent objects

The function reserve can be set via the receiver control panel and the *Sensor Studio* configuration software (see chapter 15).

The function reserve can be set via the receiver control panel, via the respective fieldbus interface (see chapter 10 et seq.) or via the *Sensor Studio* configuration software (see chapter 15).

The sensitivity levels (e.g., high function reserve for stable operation, medium function reserve and low function reserve) are configured ex works with “high function reserve for stable operation”. The “low function reserve” configuration enables the detection of partially transparent objects.

The switching threshold can be set for optimum operation for the detection of transparent objects in the “Transparent” configuration.

The structure of the configuration in the receiver control panel menu is as follows:

Level 0	Level 1	Level 2	Description			
Main Settings	Command		Teach	Reset	Factory Settings	
	Operational setting	Filter Depth				
		Beam mode				
		Function reserve	High	Medium	Low	Transparent
		Switching threshold				

↪ Select **Main Settings > Operational Settings > Function Reserve**

↪ For the switching threshold, enter a value between 10% (lowest sensitivity) and 98% (highest sensitivity).

NOTICE

Recommended switching threshold for transparent objects!

↪ For the detection of transparent objects, a switching threshold setting of 75% ... 85% is recommended. Factory setting: 75%.

8.5 Extended configurations on the receiver control panel menu

It is not mandatory that extended configurations be performed on the receiver control panel menu in order to start up a light curtain.

8.5.1 Define digital inputs/outputs

The digital IOs, IO pin x configurations (IO function, inversion, area logic, start beam, end beam, etc.) are used to configure the parameters for the switching outputs.

The individual configuration steps for the extended configuration combinations are not described separately.

When configuring start and end beam, you can configure values of up to 1774. Values above 1774 (to 1999) are not accepted and must be entered again.

The structure of these configurations in the receiver control panel menu is as follows (multiple configurations displayed simultaneously):

Examples

Configuration of pin 2 as PNP switching output

The following example shows a configuration of pin 2 as PNP switching output with additional configurations, such as area logic “OR” with a beam area of 1 ... 32 and beam 1 as start beam according to the following table.

	OR
Start Beam	1
End Beam	32
Switch-on condition	1 beam interrupted
Switch-off condition	0 beams interrupted

Level 0	Level 1	Level 2	Description				
Digital IOs	IO Logic		Positive PNP	Negative NPN			
		IO Pin 2					
		IO Function	Trigger In	Teach In	Area Out	Warn Out	Trigger Out
		Inversion	Normal	Inverted			
		Teach height	Execute	Exit			
		Area Logic	AND	OR			
		Start Beam	001				
	End Beam	032					

- ↪ Select **Digital IOs > IO Logic > Positive PNP**.
- ↪ Select **Digital IOs > IO Pin 2 > IO Function > Area Out**.
- ↪ Select **Digital IOs > IO Pin 2 > Inversion > Inverted**.
- ↪ Select **Digital IOs > IO Pin 2 > Area Logic > OR**.
- ↪ Select **Digital IOs > IO Pin 2 > Start Beam > 001**.
- ↪ Select **Digital IOs > IO Pin 2 > End Beam > 032**.

Configuration of pin 2 as PNP warning output

The following example shows the configuration of pin 2 as PNP warning output.

Level 0	Level 1	Level 2	Description				
Digital IOs	IO Logic		Positive PNP	Negative NPN			
		IO Pin 2					
		IO Function	Trigger In	Teach In	Area Out	Warn Out	Trigger Out
		Inversion	Normal	Inverted			
		Teach height	Execute	Exit			
		Area Logic	AND	OR			
		Start Beam	(enter value)				
	End Beam	(enter value)					

- ↪ Select **Digital IOs > IO Logic > Positive PNP**.
- ↪ Select **Digital IOs > IO Pin 2 > IO Function > Warn Out**.

Configuration of pin 2 as PNP trigger input

The following example shows the configuration of pin 2 as PNP trigger input.

Level 0	Level 1	Level 2	Description				
Digital IOs	IO Logic		Positive PNP		Negative NPN		
		IO Pin 2					
		IO Function	Trigger In	Teach In	Area Out	Warn Out	Trigger Out
		Inversion	Normal	Inverted			
		Teach height	Execute	Exit			
		Area Logic	AND	OR			
		Start Beam	(enter value)				
	End Beam	(enter value)					

↪ Select **Digital IOs > IO Logic > Positive PNP.**

↪ Select **Digital IOs > IO Pin 2 > IO Function > Trigger In.**

Trigger input and output are only active if cascading (triggered operation) was activated via the configuration interface or process interface.

A teach input is configured according to the same principle.

↪ Select **Digital IOs > IO Logic > Positive PNP.**

↪ Select **Digital IOs > IO Pin 2 > IO Function > Teach input.**

Configuration of pin 5 as PNP height area

The following example shows the configuration of pin 5 as PNP height area.

Level 0	Level 1	Level 2	Description				
Digital IOs	IO Logic		Positive PNP		Negative NPN		
		IO Pin 5					
		IO Function	Trigger In	Teach In	Area Out	Warn Out	Trigger Out
		Inversion	Normal	Inverted			
		Teach height	Execute	Exit			
		Area Logic	AND	OR			
		Start Beam	(enter value)				
	End Beam	(enter value)					

↪ Select **Digital IOs > IO Logic > Positive PNP.**

↪ Select **Digital IOs > IO pin 5 > Teach height > Execute.**

The height area is automatically configured as an area output.

IO Function > Area Out must also be selected.

8.5.2 Inversion of the switching behavior (light/dark switching)

Light/dark switching is configured with this configuration.

For all digital process interfaces, the configuration can also be performed via the respective field-bus interface (see chapter 10 et seq.) or via the *Sensor Studio* configuration software (see chapter 15).

The following example shows how the switching output is switched from light switching (normal) to dark switching (inverted).

The structure of the configuration in the receiver control panel menu is as follows:

Level 0	Level 1	Level 2	Description				
Digital IOs	IO Logic		Positive PNP	Negative NPN			
		IO Pin 2					
		IO Function	Trigger In	Teach In	Area Out	Warn Out	Trigger Out
		Inversion	Normal	Inverted			
		Teach height	Execute	Exit			
		Area Logic	AND	OR			
		Start Beam	(enter value)				
		End Beam	(enter value)				

↪ Select **Digital IOs > IO Pin 2 > Inversion > Inverted**.

8.5.3 Defining the filter depth

The filter depth is used to specify that an evaluation of the measurement values occurs only once the beam states are stable over multiple measurement cycles.

Example: with a filter depth of "5", five measurement cycles must be consistent before an evaluation is performed. For further information, see also the description of interference suppression (see chapter 4.12).

For all digital process interfaces, the configuration can also be performed via the respective field-bus interface (see chapter 10 et seq.) or via the *Sensor Studio* configuration software (see chapter 15).

When configuring the filter depth, you can enter values of up to 255. Values above 255 (to 299) are not accepted and must be entered again.

The structure of the configuration in the receiver control panel menu is as follows:

Level 0	Level 1	Level 2	Description		
Main Settings	Command		Teach	Reset	Factory Settings
		Operational setting			
		Filter Depth	(enter value) min = 1 max = 255		

↪ Select **Main Settings > Operational Settings > Filter Depth**.

8.5.4 Defining the display properties

With these configurations for the display, the brightness and a time unit for darkening the display are defined.

Visibility:

- Off: no display; the display remains dark until a button is pressed.
- Dark: text is only slightly visible.
- Normal: text is visible with good contrast.
- Bright: text appears very bright.
- Dynamic: The display darkens gradually over the number of seconds configured under **Time Unit (s)**. During this time span, the display passes through all levels, from bright to off.

After approx. 5 minutes without button actuation, configuration mode is exited and the display changes to the previous mode.

When configuring the **Visibility** in the dark, normal and bright modes, the display is completely inverted after approx. 15 minutes to prevent the LEDs from burning in.

When configuring the **Time Unit (s)**, you can enter values of up to 240 seconds. Values above 240 (to 299) are not accepted and must be entered again.

The structure of these configurations in the receiver control panel menu is as follows:

Level 0	Level 1	Level 2	Description
Display	Language	English German French Italian Spanish	
	Mode	Process mode Alignment	
	Visibility	Off Dark Normal Bright Dynamic	
	Time Unit (s)	(enter value) min = 1 max = 240	

↵ Select **Display > Visibility**.

↵ Select **Display > Time Unit (s)**.

8.5.5 Changing the language

The system language can be configured with this configuration.

The structure of the configuration in the receiver control panel menu is as follows:

Level 0	Level 1	Level 2	Description
Display	Language	English German French Italian Spanish	

↵ Select **Display > Language**.

8.5.6 Product information

With this configuration, you can read out product data (part number, type designation and other production-specific data) of the light curtain.

The structure of the configuration in the receiver control panel menu is as follows:

Level 0	Level 1	Level 2	Description
Information			
	Product name		CML 730i
	Product ID		Receiver part no. (e.g., 50119835)
	Serial number		Receiver serial number (e.g., 01436000288)

Level 0	Level 1	Level 2	Description
	Tx.transmitter-ID		Transmitter part no. (e.g., 50119407)
	Tx.transmitter-SN		Transmitter serial no. (e.g., 01436000289)
	FW version		e.g., 01.61
	HW version		e.g., A001
	Kx version		e.g., P01.30e

↪ Select **Information**.

8.5.7 Reset to factory settings

Factory settings can be restored with this configuration.

The structure of this menu item in the receiver control panel menu is as follows:

Level 0	Level 1	Level 2	Description
Main Settings	Command	Teach	
		Reset	Factory Settings

↪ Select **Main Settings > Command > Factory Settings**.

9 Starting up the device - Analog output

9.1 Analog output configuration on the receiver control panel

The configuration of the analog output involves the following steps on the receiver control panel.



The configurations can be performed via the receiver control panel or the *Sensor Studio* configuration software (see chapter 15). These configurations are stored in non-volatile memory so that they are retained the next time the device is switched on.

It is always the last-made settings which are active.

General prerequisites:

- The measuring light curtain has been mounted (see chapter 6) and connected (see chapter 7 "Electrical connection") correctly.
- The basic configuration has been performed (see chapter 8).

Configuration of analog signal, analog function, characteristic curve (start beam / end beam)

The following example shows the configuration of an analog output to 4 ... 20 mA. Current output pin 7 supplies an analog output signal depending on the first (FIB) interrupted beam. The measurement range goes from beam no. 1 ... 32.

Structure of the analog signal, analog function, characteristic curve (start beam, end beam) settings in the receiver control panel menu (multiple settings shown simultaneously):

Level 0	Level 1	Level 2	Description
Analog Output	Analog Signal	Off U: 0 ... 5 V U: 0 ... 10 V U: 0 ... 11 V I: 4 ... 20 mA I: 0 ... 20 mA I: 0 ... 24 mA	
	Analog Function	Off FIB FNIB LIB LNIB TIB TNIB	
	Start Beam	001	
	End Beam	032	

↪ Select the type of analog signal.

Off, or a defined voltage level and/or current level.

↪ Select the evaluation function whose result is to be depicted on the analog output.

Off, or FIB; FNIB; LIB; LNIB; TIB; TNIB.

↪ Set the start of the characteristic curve.

The start of the characteristic curve is defined by the start beam.

↪ Set the end of the characteristic curve.

The end of the characteristic curve is defined by the end beam.



By entering End Beam < Start Beam, the characteristic curve of the analog output can be inverted.

The analog-device-specific configuration is concluded. The CML 700i is ready for process mode.

9.2 Analog output configuration via the *Sensor Studio* configuration software

The configuration of the analog output involves the following steps in the *Sensor Studio* configuration software (see chapter 15).



The configurations that are available in the IODD file via the *Sensor Studio* configuration software (see chapter 15) can, in part, also be performed via the receiver control panel. Both configuration types are stored in non-volatile memory so that they are retained the next time the device is switched on.

It is always the last set configurations which are active. If the last changes to the configuration were made via the receiver control panel, any settings changed via, e.g., the control or PC are overwritten.

General prerequisites:

- The measuring light curtain has been mounted (see chapter 6) and connected (see chapter 7) correctly.
- The measuring light curtain is connected to a PC via an IO-Link USB master (see chapter 15).
- *Sensor Studio* (incl. device-specific IODD file) is installed on the PC (see chapter 15).
- The basic configuration has been performed (see chapter 8).



The IO Device Description (IODD) can be used both with connected light curtain for direct configuration or without connected light curtain for creating device configurations.

The IODD file is supplied with the product CD. An updated version can also be downloaded from the Internet at www.leuze.com.

↪ Open the *Sensor Studio* configuration software on the PC (see chapter 15).

↪ Configure the following parameters:

- Smoothing (definition of a beam number for which no object detection is yet detected)
- Type of analog signal (off; or selection of defined voltage level and/or current level) (see chapter 9)
- Type of analog function (off; or FIB; FNIB; LIB; LNIB; TIB; TNIB) (see chapter 9)
- Characteristic curve configuration (start beam and end beam) (see chapter 9.3)
- Filter depth (definition of a minimum number of measurement cycles after which beam evaluation is performed)

↪ If necessary, configure additional parameter/process data with the aid of the process data table (see chapter 10.3).

↪ Save the configuration in the CML 700i.

The CML 700i is ready for process mode.

9.3 Behavior of the analog output

The output logic of the CML 700i returns the output signals to the programmable logic control (PLC). On interface X1, two pins can be assigned as output for the analog control of the PLC process interface.

The selected beam area (start beam/end beam) is mapped to the analog output of the CML 700i. The conversion is by means of a 12-bit D/A converter, whereby the 12-bit value (4096) is divided by the selected number of beams. The resulting values, mapped to the respective, configured analog values, yield the characteristic curve. If there are only a few beams, this results in an erratic characteristic curve.



The beams used for the measurement can be freely defined via the receiver control panel. It is also possible to specify that only a part of the beam area be used for the measurement.

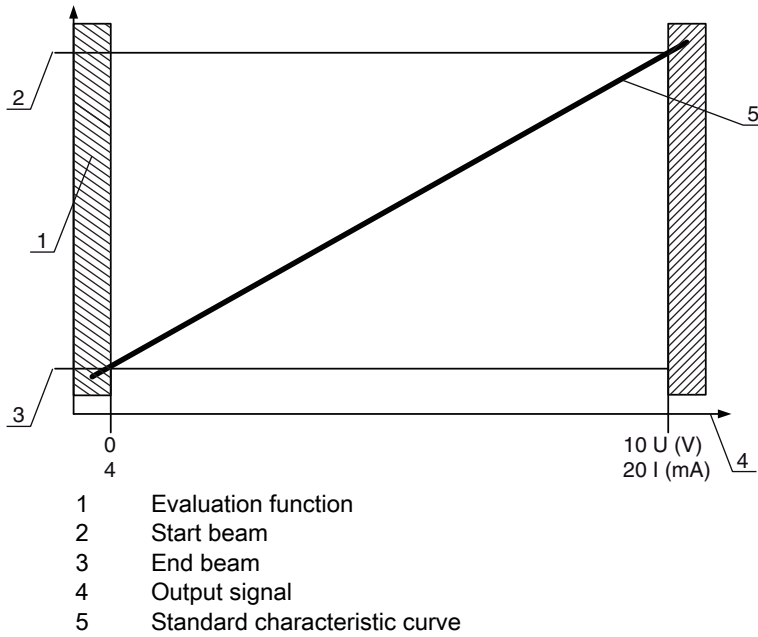

Figure 9.1: Characteristic curve of analog output (default characteristic curve)

If a higher beam number is selected for the beginning of the measurement range than for the end of the measurement range, the characteristic curve is inverted.

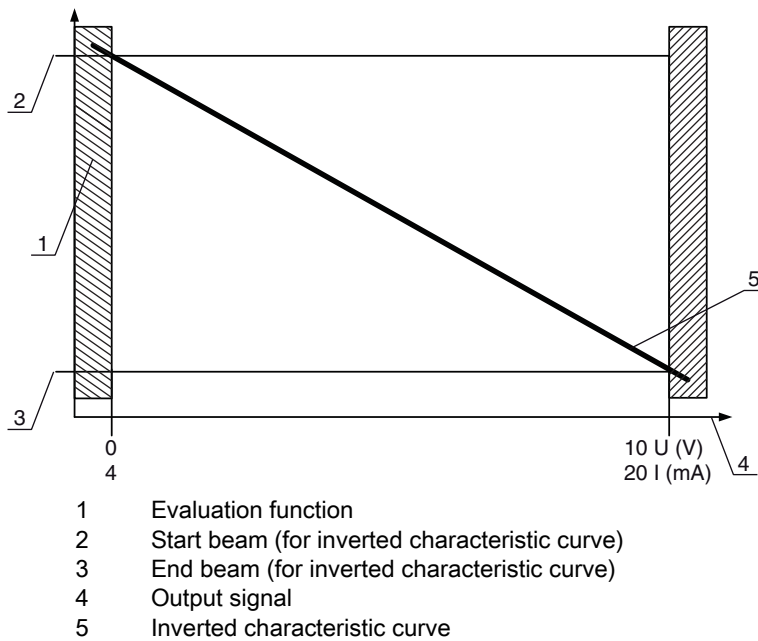

Figure 9.2: Characteristic curve of analog output (inverted characteristic curve)

Overview: states of the analog output

Configuration for height and edge measurement			Analog value corresponding to the beam state	
			All free	All or end beam interrupted
Standard	Start Beam	End Beam	4 mA	20 (24) mA
			0 V	(5) 10 (11) V
Inverted	End Beam	Start Beam	20 (24) mA	4 mA
			(5) 10 (11) V	0 V

The rise time of the analog output from 0% to 100% can take up to 2 ms. To keep the control from evaluating the analog value of a rising edge, configure the control so that a value is detected as valid if it remains unchanged for a certain length of time.

10 Starting up the device - IO-Link interface

The configuration of an IO-Link interface involves the following steps on the receiver control panel and the IO-Link master module of the control-specific configuration software.

General prerequisites:

- The measuring light curtain has been mounted (see chapter 6) and connected (see chapter 7) correctly.
- The basic configuration has been performed (see chapter 8).

10.1 Defining IO-Link device configurations on the receiver control panel

The parameters for the IO-Link interface are configured with the bit rate and process data length (PD length) configurations. By changing the bit rate and/or the process data length, the light curtain receives a new IO-Link device ID and must be operated with the compatible IO Device Description (IODD).

NOTICE

Changes take effect immediately!

↪ The changes take effect immediately (without restarting).

↪ The IODD file is supplied with the device and is available for download at www.leuze.com.



Factory Settings:

Bit rate (COM2) = 38.4 kbit/s

PD length: 2 bytes

The structure of these configurations in the receiver control panel menu is as follows:

Level 0	Level 1	Level 2	Description
Main Settings	Command		
	Operational setting		
	IO-Link	Bit rate	COM3: 230.4 COM2: 38.4
		PD Length	2 bytes 8 bytes 32 bytes
Data Storage		Deactivated Activated	

↪ Select **Main Settings > IO-Link > Bit rate**.

↪ Select **Main Settings > IO-Link > PD-Length**.

The bit rate and PD length are configured.

Other possible configuration steps are performed via the *Sensor Studio* configuration software (see chapter 15).

Process mode is configured via the IO-Link master module of the control-specific software.

10.2 Defining configurations via the IO-Link master module of the PLC-specific software

General prerequisites:

- The measuring light curtain has been mounted (see chapter 6) and connected (see chapter 7) correctly.
- The basic configuration has been performed (see chapter 8).
- IO-Link-specific basic configurations have been performed.
 - IO-Link bit rate selected
 - IO-Link PD length selected



The IO Device Description (IODD) can be used both with connected light curtain for direct configuration or without connected light curtain for creating device configurations.

The IODD files are supplied with the product. The IODD can also be downloaded from the Internet at www.leuze.com.

- ↗ Open the configuration software of the IO-Link master module.
- ↗ Configure the following parameters:
 - Beam mode (parallel-, diagonal-, crossed-beam)
 - Blanking settings
 - Teach settings
- ↗ Perform a teach. This is possible via the receiver control panel or the control group in the IO-Link process data (IO-Link object 2).
- ↗ If necessary, configure additional parameter/process data (see chapter 10.3).
- ↗ Save the configuration via the control group in the IO-Link process data (IO-Link object 2).

The IO-Link-specific configurations are performed and copied to the device. The device is prepared for process mode.

10.3 Parameter/process data for IO-Link

The parameter data and process data are described in the IO-Link Device Description (IODD) file. Details on the parameters and on the structure of the process data can be found in the **.html** document, which is contained in the **IODD zip file**.



Sub-index access is not supported.

Overview

Group	Group name
Group 1	System commands (see page 78)
Group 2	CML 700i status information (see page 78)
Group 3	Device description (see page 78)
Group 4	General configurations (see page 80)
Group 5	Extended settings (see page 81)
Group 6	Process data settings (see page 81)
Group 7	Cascading/trigger settings (see page 82)
Group 8	Blanking settings (see page 83)
Group 9	Teach settings (see page 84)
Group 10	Digital IO pin N settings (N = 2, 5, 6, 7) (see page 85)
Group 11	Time module settings for digital outputs (see page 86)
Group 12	Analog device settings (see page 87)
Group 13	Autosplitting (see page 88)
Group 14	Configuration for block evaluation of beam areas (see page 88)
Group 15	Evaluation functions (see page 90)

System commands (group 1)



The system commands trigger a direct action in the device.

Parameter	Index	Sub-index	Data type	Access	Value range	Default	Description
System command	2		unsigned 8	WO	128, 130, 162, 163		128: Reset device 130: Factory reset 162: Perform teach 163: Save settings Notice: Processing of the Save command takes up to 600 ms. During this time, no other data/telegrams are accepted.

CML 700i status information (group 2)



The status information consists of operating state information or error messages.

Parameter	Index	Sub-index	Data type	Access	Value range	Default	Description
CML 700i status information	162	0	unsigned 16	RO			Operating state information or error messages

Parameter	Index	Sub-index	Data type	Access	Value range	Default	Description
Status of teach event	69	0	unsigned 8	RO	0, 1, 128	0	Status information on teach event 0: Teach successful 1: Teach running 128: Teaching error
Alignment	70	0	record 32 bit, isolated access to sub-index not possible	RO			Information on the signal level of the first and last beam. The value changes depending on the selected function reserve.
Signal level of last beam	70	1 (bit offset = 16)	unsigned 16	RO		0	
Signal level of first beam	70	2 (bit offset = 0)	unsigned 16	RO		0	

Device description (group 3)



The device description specifies the device characteristics, e.g., beam spacing, the number of physical/logical individual beams, the number of cascades (16 individual beams) in the device and the cycle time.

Parameter	Index	Sub-index	Data type	Access	Value range	Default	Description
Manufacturer name	16	0	string 32 bytes	RO			Leuze electronic GmbH + Co. KG
Manufacturer text	17	0	string 64 bytes	RO			Leuze electronic - the sensor people
Product name	18	0	string 64 bytes	RO			Receiver type designation
Product ID	19	0	string 20 bytes	RO			Order number of the receiver (8-digit)
Product text	20	0	string 64 bytes	RO			"Measuring light curtain CML 730i"
Serial number Receiver	21	0	string 16 bytes	RO			Serial number of the receiver for unique product identification
Hardware version	22	0	string 20 bytes	RO			
Firmware version	23	0	string 20 bytes	RO			
User-specific name	24	0	string 32 bytes	RW		***	Device designation defined by the user
Device status	36	0	unsigned 8	R	0 ... 4		Value: 0 device is OK Value: 1 maintenance required Value: 2 outside of specifications Value: 3 function test Value: 4 error
Receiver part no.	64	0	string 20 bytes	RO			Order number of the receiver (8-digit)
Transmitter product designation	65	0	string 64 bytes	RO			Type designation
Transmitter part no.	66	0	string 20 bytes	RO			Order number of the transmitter (8-digit)
Transmitter serial number	67	0	string 16 bytes	RO			Transmitter serial number for unique product identification
Device characteristics	68	0	record 80 bit, isolated access to sub-index not possible	RO			The device characteristics specify the beam spacing, the number of physical/logical individual beams, the number of cascades (16 individual beams) in the device and the cycle time.
Beam spacing	68	1 (bit offset = 64)	unsigned 16	RO	5, 10, 20, 40	5	Distance between two adjacent optical individual beams.
Number of physical individual beams	68	2 (bit offset = 48)	unsigned 16	RO		16	
Number of configured logical individual beams	68	3 (bit offset = 32)	unsigned 16	RO		16	The number of logical individual beams is dependent on the selected operating mode. The evaluation functions of the CML 700i are calculated on the basis of the logical individual beams.
Segment number of a beam-stream with 16 beams	68	4 (bit offset = 16)	unsigned 16	RO		1	The CML 700i has a modular structure. 16 or 32 individual beams are always grouped into a cascade.
Device cycle time	68	5 (bit offset = 0)	unsigned 16	RO		1000	The device cycle time defines the duration of a measurement cycle of the CML 700i.

Parameter	Index	Sub-index	Data type	Access	Value range	Default	Description
Device version	90	0	unsigned 32	RW	1 ... 6	1	Interfaces: 1: Reserved 2: Analog device with 2x inputs/outputs 3: IO-Link device with 4x inputs/outputs 4: CANopen device with 2x inputs/outputs 5: Profibus device with 2x inputs/outputs 6: RS 485 Modbus device with 2x inputs/outputs
CANopen settings	91	0	record 16 bit, isolated access to sub-index not possible				Node ID and bit rate are set under CANopen settings.
CANopen bit rate	91	1 (bit offset = 8)	unsigned 8		0 ... 3	0	0: 1000 kbit/s 1: 500 kbit/s 2: 250 kbit/s 3: 125 kbit/s
CANopen node ID	91	2 (bit offset = 0)	unsigned 8	RW	1 ... 127	10	
Profibus settings	92	0	record 32 bit, isolated access to sub-index not possible				Profibus settings: bus address, bit rate
Profibus bit rate	92	1 (bit offset = 8)	unsigned 8		0 ... 3	6	0: 9.6 kbit/s 1: 19.2 kbit/s 2: 45.45 kbit/s 3: 93.75 kbit/s 4: 187.5 kbit/s 5: 500 kbit/s 6: 1500 kbit/s 7: 3000 kbit/s
Bus address	92	2 (bit offset = 8)	unsigned 8	RW	1 ... 126	126	

General configurations (group 4)



Configured under group 4 “General configurations” are the type of scanning (parallel-/diagonal-/crossed-beam), counting direction and minimum object diameter for the evaluation (smoothing). The minimum hole size for the evaluation, e.g., with web material, is configured via inverted smoothing.

Parameter	Index	Sub-index	Data type	Access	Value range	Default	Description
General settings	71	0	record 32 bit, isolated access to sub-index not possible	RW			
Beam mode	71	1 (bit offset = 24)	unsigned 8	RW	0 ... 2	0	0: Parallel-beam scanning 1: Diagonal-beam scanning 2: Crossed-beam scanning

Parameter	Index	Sub-index	Data type	Access	Value range	Default	Description
Counting direction	71	2 (bit offset = 16)	unsigned 8	RW	0 ... 1	0	0: Normal - beginning at the connection side, 1: Inverted – beginning opposite the connection side
Smoothing	71	3 (bit offset = 8)	unsigned 8	RW	1 ... 255	1	Smoothing: Less than i interrupted beams are ignored.
Inverted smoothing	71	4 (bit offset = 0)	unsigned 8	RW	1 ... 255	1	Inverted smoothing: Less than i free beams are ignored.

Extended settings (group 5)



The extended settings specify the filter depth, integration time (hold function) and button lock on the receiver control panel.

Parameter	Index	Sub-index	Data type	Access	Value range	Default	Description
Extended settings	74	0	record 32 bit, isolated access to sub-index not possible	RW			
Filter Depth	74	2 (bit offset = 16)	unsigned 8	RW	1 ... 255	1	The filter depth indicates the necessary number of consistent beam states before the evaluation of the measurement values. The filter depth corresponds to the number of passes with interrupted beam so that the result leads to switching.
Integration time	74	3 (bit offset = 0)	unsigned 8	RW	0 ... 65535	0	All measurement values are accumulated and retained over the duration of the integration time. Hold function in ms.
Button lock and display	78	0	unsigned 8	RW	0 ... 1	0	Lock operational controls on the device. 0: Enabled 1: Locked

Process data settings (group 6)



The process data settings describe the cyclically transmitted process data.

The process data extension permits the serial output of the individual pieces of beam data. Each individual beam can be processed and transferred as a bit independent of measurement field length, resolution and beam mode (beginning with firmware version v2.10).

NOTICE

A maximum of 256 beams can be processed as a bit!

- ↳ The IO-Link specification only permits 32 bytes as process data; i.e., up to 256 beams can each be processed and transmitted as a bit.
- ↳ Through the limitation of the process data length, the beams, depending on the resolution, can only be processed and transmitted up to a certain measurement field length as a bit.

Examples for the limitation of the measurement field length:

- Resolution of 5 mm: Measurement field length up to 1280 mm
- Resolution of 10 mm: Measurement field length up to 2560 mm
- Resolution of 20 mm, 40 mm: No limitation of the measurement field length

Parameter	Index	Sub-index	Data type	Access	Value range	Default	Description
Process data settings	72	0	record 128 bit, isolated access to sub-index not possible	RW			
Evaluation function module 01	72 (bit offset = 120)	1	unsigned 8	RW	1 ... 111, 0, 200 ... 205, 208 ... 210, 212	202	1 ... 111: Number of optical cascades for beam-stream evaluation (16 beams) 0: No evaluation (NOP) 200: First interrupted beam (FIB) 201: First uninterrupted beam (FNIB) 202: Last interrupted beam (LIB) 203: Last uninterrupted beam (LNIB) 204: Number of interrupted beams (TIB) 205: Number of uninterrupted beams (TNIB) 208: Switching state of areas 16 ... 1 209: Switching state of areas 32 ... 17 210: Switching state of the outputs mapped to the areas 212: CML 700i status information
Evaluation function module 02	72 (bit offset = 112)	2	unsigned 8	RW	1 ... 111, 0, 200 ... 205, 208 ... 210, 212	0	1 ... 111: Number of optical cascades for beam-stream evaluation (16 beams) 0: No evaluation (NOP) 200: First interrupted beam (FIB) 201: First uninterrupted beam (FNIB) 202: Last interrupted beam (LIB) 203: Last uninterrupted beam (LNIB) 204: Number of interrupted beams (TIB) 205: Number of uninterrupted beams (TNIB) 208: Switching state of areas 16 ... 1 209: Switching state of areas 32 ... 17 210: Switching state of the outputs mapped to the areas 212: CML 700i status information
.....
.....
Evaluation function module 16	72 (bit offset = 0)	1	unsigned 8	RW	1 ... 111, 0, 200 ... 205, 208 ... 210, 212	0	1 ... 111: Number of optical cascades for beam-stream evaluation (16 beams) 0: No evaluation (NOP) 200: First interrupted beam (FIB) 201: First uninterrupted beam (FNIB) 202: Last interrupted beam (LIB) 203: Last uninterrupted beam (LNIB) 204: Number of interrupted beams (TIB) 205: Number of uninterrupted beams (TNIB) 208: Switching state of areas 16 ... 1 209: Switching state of areas 32 ... 17 210: Switching state of the outputs mapped to the areas 212: CML 700i status information

Cascading/trigger settings (group 7)



To prevent mutual interference, multiple light curtains can be operated with a time offset with respect to one another (cascade). Here, the master generates the cyclical trigger signal; the slaves start their measurement after delay times, which are to be set to different values.

Parameter	Index	Sub-index	Data type	Access	Value range	Default	Description
Trigger Settings	73	0	record 64 bit, isolated access to sub-index not possible	RW			
Cascading	73	1 (bit offset = 56)	unsigned 8	RW	0 ... 1	0	0: Not active (constant measurement of the sensor) 1: Active (sensor expects trigger signal)
Function type	73	2 (bit offset = 48)	unsigned 8	RW	0 ... 1	0	0: Slave (expects trigger signal) 1: Master (sends trigger signal)
Trigger delay time → Start measurement	73	3 (bit offset = 32)	unsigned 16	RW	500 ... 65535	500	Unit: µs
Master cycle time	73	5 (bit offset = 0)	unsigned 16	RW	1 ... 6500	1	Unit: ms

Blanking settings (group 8)



Up to four beam areas can be deactivated. Deactivated beams can be assigned the logical values 0, 1 or the value of the adjacent beam. With auto blanking activated, up to four beam areas are automatically suppressed during teaching.

Auto blanking should only be activated during commissioning of the CML 700i to suppress interfering objects. In process mode, auto blanking should be deactivated.

For details on this topic see chapter 14.4.

NOTICE
Perform teach after changing the blanking configuration!
↪ Perform a teach after changing the blanking configuration.
A teach can be performed via the receiver control panel or via the teach command.

Parameter	Index	Sub-index	Data type	Access	Value range	Default	Description
Blanking settings	76	0	record 208 bit, isolated access to sub-index not possible	RW			
Number of auto-blanking areas	76	1 (bit offset = 200)	unsigned 8	RW	0 ... 4	0	Permissible number of auto-blanking areas 0: 0 auto-blanking areas 1: 1 auto-blanking area 2: 2 auto-blanking areas 3: 3 auto-blanking areas 4: 4 auto-blanking areas
Auto blanking (during teaching)	76	2 (bit offset = 192)	unsigned 8	RW	0 ... 1	0	0: Not active (manual blanking area configuration) 1: Active (automatic area configuration through teach)
Logical value for blanking area 1	76	3 (bit offset = 176)	unsigned 16	RW	0 ... 4	0	0: No beams blanked 1: Logical value 0 for blanked beams 2: Logical value 1 for blanked beams 3: Logical value = same as adjacent beam with lower beam number 4: Logical value = same as adjacent beam with higher beam number

Parameter	Index	Sub-index	Data type	Access	Value range	Default	Description
Start beam of blanking area 1	76	4 (bit offset = 160)	unsigned 16	RW	1 ... 1774	1	
End beam of blanking area 1	76	5 (bit offset = 160)	unsigned 16	RW	1 ... 1774	1	
Logical value for blanking area 2	76	6 (bit offset = 128)	unsigned 16	RW	0 ... 4	0	0: No beams blanked 1: Logical value 0 for blanked beams 2: Logical value 1 for blanked beams 3: Logical value = same as adjacent beam with lower beam number 4: Logical value = same as adjacent beam with higher beam number
Start beam of blanking area 2	76	7 (bit offset = 112)	unsigned 16	RW	1 ... 1774	1	
End beam of blanking area 2	76	8 (bit offset = 96)	unsigned 16	RW	1 ... 1774	1	
.....
.....
Logical value for blanking area 4	76	12 (bit offset = 32)	unsigned 16	RW	0 ... 4	0	0: No beams blanked 1: Logical value 0 for blanked beams 2: Logical value 1 for blanked beams 3: Logical value = same as adjacent beam with lower beam number 4: Logical value = same as adjacent beam with higher beam number
Start beam of blanking area 4	76	13 (bit offset = 16)	unsigned 16	RW	1 ... 1774	1	
End beam of blanking area 4	76	14 (bit offset = 0)	unsigned 16	RW	1 ... 1774	1	

Teach settings (group 9)



In most applications, it is recommended that teach values be stored in non-volatile memory (permanent).

Depending on the function reserve selected for the teach event, the sensitivity is higher or lower (high function reserve = low sensitivity; low function reserve = high sensitivity).

Parameter	Index	Sub-index	Data type	Access	Value range	Default	Description
Teach Settings	79	0	record 32 bit, isolated access to sub-index not possible	RW			

Parameter	Index	Sub-index	Data type	Access	Value range	Default	Description
Type of storage for teach values	79	2 (bit offset = 16)	unsigned 8	RW	0 ... 1	0	0: Non-volatile storage of teach values 1: Teach values stored only while voltage is ON
Sensitivity adjustment for teach event	79	3 (bit offset = 8)	unsigned 8	RW	0 ... 3	0	Sensitivity of the measurement system: 0: High function reserve (for stable operation) 1: Medium function reserve 2: Low function reserve 3: Transparent media
Switching threshold	79	4 (bit offset = 0)	unsigned 8	RW	10 ... 98	75	Threshold as percentage of teach threshold (50% = function reserve 2)

Digital IO pin N settings (N = 2, 5, 6, 7) (group 10)



In this group, the inputs/outputs can be set to positive switching (PNP) or to negative switching (NPN). The switching behavior applies the same for all inputs/outputs.

Moreover, the inputs/outputs can be configured via this group: pin 2, 5, 6, 7 for IO-Link devices, pin 2, 5 for analog or fieldbus devices.

Parameter	Index	Sub-index	Data type	Access	Value range	Default	Description
Switching level of the inputs/outputs	77	0	unsigned 8	RW	0 ... 1	1	0: Transistor, NPN 1: Transistor, PNP
Configuration of pin 2							
Digital IO Pin 2 Settings	80	0	record 32 bit, isolated access to sub-index not possible	RW			
Input/output selection	80	1 (bit offset = 24)	unsigned 8	RW	0 ... 1	0	0: Output 1: Input
Switching behavior	80	2 (bit offset = 16)	unsigned 8	RW	0 ... 1	0	0: Normal - light switching 1: Inverted - dark switching
Input function	80	3 (bit offset = 8)	unsigned 8	RW	0 ... 2	0	0: Not active 1: Trigger input 2: Teach input
Output function	80	4 (bit offset = 0)	unsigned 8	RW	0 ... 3	0	0: Not active 1: Switching output (area 1 ... 32) 2: Warning output 3: Trigger output
Configuration of pin 7							
Digital IO Pin 7 Settings	83	0	record 32 bit, isolated access to sub-index not possible	RW			
Input/output selection	83	1 (bit offset = 24)	unsigned 8	RW	0 ... 1	0	0: Output 1: Input

Parameter	Index	Sub-index	Data type	Access	Value range	Default	Description
Switching behavior	83	2 (bit offset = 16)	unsigned 8	RW	0 ... 1	0	0: Normal - light switching 1: Inverted - dark switching
Input function	83	3 (bit offset = 8)	unsigned 8	RW	0 ... 2	0	0: Not active 1: Trigger input 2: Teach input
Output function	83	4 (bit offset = 0)	unsigned 8	RW	0 ... 3	0	0: Not active 1: Switching output (area 1 ... 32) 2: Warning output 3: Trigger output

Settings for digital switching outputs (group 11)



In this group, the beam areas can be mapped to the switching outputs and assigned a time function.

Parameter	Index	Sub-index	Data type	Access	Value range	Default	Description
Configuration of pin 2							
Configuration of switching output pin 2	84	0	record 56 bit, isolated access to sub-index not possible	RW			Four different time functions can be set. Max. time duration that can be set is 65 s. Map the output to switching areas 1 ... 32.
Operating mode of the time module	84	1 (bit offset = 48)	unsigned 8	RW	0 ... 4	0	0: Not active 1: Start-up delay 2: Switch-off delay 3: Pulse stretching 4: Pulse suppression
Time constant for selected function	84	2 (bit offset = 32)	unsigned 8	RW	0 ... 65,000	0	Unit: ms
Area mapping 32 ... 25	84	3 (bit offset = 24)	unsigned 8	RW		0b000 00000	
Area mapping 24 ... 17	84	4 (bit offset = 16)	unsigned 8	RW		0b000 00000	
Area mapping 16 ... 9	84	5 (bit offset = 8)	unsigned 8	RW		0b000 00000	
Area mapping 8 ... 1	84	6 (bit offset = 0)	unsigned 8	RW		0b000 00001	
.....
.....
Configuration of pin 7							
Configuration of switching output pin 7	87	0	record 56 bit, isolated access to sub-index not possible	RW			Four different time functions can be set. Max. time duration that can be set is 65 s. Map the output to switching areas 1 ... 32.
Operating mode of the time module	87	1 (bit offset = 48)	unsigned 8	RW	0 ... 4	0	0: Not active 1: Start-up delay 2: Switch-off delay 3: Pulse stretching 4: Pulse suppression

Parameter	Index	Sub-index	Data type	Access	Value range	Default	Description
Time constant for selected function	87	2 (bit offset = 32)	unsigned 16	RW	0 ... 65,000	8	Unit: ms
Area mapping 32 ... 25	87	3 (bit offset = 24)	unsigned 8	RW		0b00000000	
Area mapping 24 ... 17	87	4 (bit offset = 16)	unsigned 8	RW		0b00000000	
Area mapping 16 ... 9	87	5 (bit offset = 8)	unsigned 8	RW		0b00000000	
Area mapping 8 ... 1	87	6 (bit offset = 0)	unsigned 8	RW		0b00000001	

Analog device settings (group 12)



In this group, various parameters can be used to set the analog device configurations, e.g. the configuration of the analog output level and how the evaluation function that is represented on the analog output is selected.

Parameter	Index	Sub-index	Data type	Access	Value range	Default	Description
Signal level	88	0	unsigned 8	RW	0 ... 6	0	Configuration of the analog output level: voltage: 0 ... 5 V voltage: 0 ... 10 V voltage: 0 ... 11 V current: 4 ... 20 mA current: 0 ... 20 mA current: 0 ... 24 mA 0: Not active 1: Voltage: 0 ... 5 V 2: Voltage: 0 ... 10 V 3: Voltage: 0 ... 11 V 4: Current: 4 ... 20 mA 5: Current: 0 ... 20 mA 6: Current: 0 ... 24 mA
Evaluation function	89	0	record 48 bit, isolated access to sub-index not possible	RW			Selection of the evaluation function that is represented on the analog output: first interrupted/uninterrupted beam (FIB/FNIB), last interrupted/uninterrupted beam (LIB/LNIB), number of interrupted/uninterrupted beams (TIB/TNIB)
Analog Function	89	1 (bit offset = 40)	unsigned 8	RW	0 ... 6	0	0: No evaluation (NOP) 1: First interrupted beam (FIB) 2: First uninterrupted beam (FNIB) 3: Last interrupted beam (LIB) 4: Last uninterrupted beam (LNIB) 5: Number of interrupted beams (TIB) 6: Number of uninterrupted beams (TNIB)
Start beam for analog measurement range	89	2 (bit offset = 16)	unsigned 16	RW	1 ... 1774	1	
End beam for analog measurement range	89	3 (bit offset = 16)	unsigned 16	RW	1 ... 1774	1	

Autosplitting (group 13)



In this group, it is possible to split all logical beams into areas of identical size. The fields of areas 01 ... 32 are thereby automatically configured.

Parameter	Index	Sub-index	Data type	Access	Value range	Default	Description
Automatic splitting	98	0	unsigned 16	RW	1 ... 32 1: (active: all beams free - not active: = one beam interrupted) 257 ... 288 2: (active: one beam free - not active: = all beams interrupted)	1: (active: all beams free - not active: = one beam interrupted)	Splitting of all logical beams into areas of identical size according to the number of areas set under "Number of areas". The fields of areas 01 ... 32 are thereby automatically configured. 1: (active: all beams free - not active: ≥ one beam interrupted) 1: One area ... 32: Thirty-two areas 2: (active: one beam free - not active: = all beams interrupted) 257: One area ... 288: Thirty-two areas
Evaluation of the beams in the area	98	1 (bit offset = 8)	unsigned 8	RW	0 ... 1	0	0: OR combination 1: AND combination
Number of areas (evenly split)	98	2 (bit offset = 0)	unsigned 8	RW	1 ... 32	1	

Configuration for block evaluation of beam areas (group 14)



In this group, a detailed area configuration can be displayed and a beam area configured for the block evaluation.

Parameter	Index	Sub-index	Data type	Access	Value range	Default	Description
Display detailed area configuration	99	0	unsigned 8	RW	0 ... 32	0	Select the desired area (1 ... 32) for which the configuration is to be edited in detail. 0: Area 01 1: Area 02 2: Area 03 ... 31: Area 32
Configuration of area 1							
Configuration of area 01	100	0	record 112 bit, isolated access to sub-index not possible	RW			Configuration of the area: definition of the status conditions so that the area takes on a logical 1 or 0. For diagonal- or crossed-beam scanning, the numbers of the logical beams are to be entered.
Area	100	1 (bit offset = 104)	unsigned 8	RW	0 ... 1	0	0: Not active 1: Active
Active beam	100	2 (bit offset = 96)	unsigned 8	RW	0 ... 1	0	0: Light switching (beam is active if light path is free) 1: Dark switching (beam is active if light path is interrupted)
Start beam of the area	100	3 (bit offset = 80)	unsigned 8	RW	1 ... 1774 65534 65533 65532 65531	1	65534: First interrupted beam (FIB) 65533: First uninterrupted beam (FNIB) 65532: Last interrupted beam (LIB) 65531: Last uninterrupted beam (LNIB)

Parameter	Index	Sub-index	Data type	Access	Value range	Default	Description
End beam of the area	100	4 (bit offset = 64)	unsigned 8	RW	1 ... 1774 65534 65533 65532 65531	1	65534: First interrupted beam (FIB) 65533: First uninterrupted beam (FNIB) 65532: Last interrupted beam (LIB) 65531: Last uninterrupted beam (LNIB)
Number of active beams for area ON	100	5 (bit offset = 48)	unsigned 16	RW	0 ... 1774	0	
Number of active beams for area OFF	100	6 (bit offset = 32)	unsigned 16	RW	0 ... 1774	0	
Specified middle of the area	100	7 (bit offset = 16)	unsigned 16	RW	0 ... 1774	0	
Specified width of the area	100	8 (bit offset = 0)	unsigned 16	RW	0 ... 1774	0	
.....
.....
Configuration of area 32							
Configuration of area 32	131	0	record 112 bit, isolated access to sub-index not possible	RW			Configuration of the area: definition of the status conditions so that the area takes on a logical 1 or 0. For diagonal- or crossed-beam scanning, the numbers of the logical beams are to be entered.
Area	131	1 (bit offset = 104)	unsigned 8	RW	0 ... 1	0	0: Not active 1: Active
Active beam	131	2 (bit offset = 96)	unsigned 8	RW	0 ... 1	0	0: Light switching (beam is active if light path is free) 1: Dark switching (beam is active if light path is interrupted)
Start beam of the area	131	3 (bit offset = 80)	unsigned 8	RW	1 ... 65534	1	
End beam of the area	131	4 (bit offset = 64)	unsigned 16	RW	1 ... 65534	1	
Number of active beams for area ON	131	5 (bit offset = 48)	unsigned 16	RW	1 ... 1774	0	
Number of active beams for area OFF	131	6 (bit offset = 32)	unsigned 16	RW	1 ... 1774	0	
Specified middle of the area	131	7 (bit offset = 16)	unsigned 16	RW	1 ... 1774	0	
Specified width of the area	131	8 (bit offset = 0)	unsigned 16	RW	1 ... 1774	0	

Evaluation functions (group 15)



In this group, all evaluation functions can be configured.

Parameter	Index	Sub-index	Data type	Access	Value range	Default	Description
First interrupted beam (FIB)	150	0	unsigned 16	RO			Logical beam number of the first darkened individual beam. The logical beam numbers change to the "diagonal" or "crossed-beam" mode. Note any changed configuration of the counting direction!
First uninterrupted beam (FNIB)	151	0	unsigned 16	RO			Logical beam number of the first undarkened individual beam. The logical beam numbers change to the "diagonal" or "crossed-beam" mode. Note any changed configuration of the counting direction!
Last interrupted beam (LIB)	152	0	unsigned 16	RO			Logical beam number of the last darkened individual beam. The logical beam numbers change in diagonal- or crossed-beam mode. Note any changed configuration of the counting direction!
Last uninterrupted beam (LNIB)	153	0	unsigned 16	RO			Logical beam number of the last undarkened individual beam. The logical beam numbers change to the "diagonal" or "crossed-beam" mode. Note any changed configuration of the counting direction!
Number of interrupted beams (TIB)	154	0	unsigned 16	RO			Sum of all darkened individual beams. The sum changes to the "diagonal" or "crossed-beam" mode.
Number of uninterrupted beams (TNIB)	155	0	unsigned 16	RO			Sum of all undarkened individual beams. The sum changes to the "diagonal" or "crossed-beam" mode.
Area Out - LoWord	158	0	unsigned 16	RO			Status of areas 01 ... 16 as 2 bytes of process data
Area Out - HiWord	159	0	unsigned 16	RO			Status of areas 17 ... 32 as 2 bytes of process data
Result of the area evaluation mapped to pins	160	0	record 16 bit, isolated access to sub-index not possible	RO			Logical status of the area evaluations mapped to the pin
Reserved	160	1 (bit offset = 4)	unsigned 16	RO			
Pin 7	160	2 (bit offset = 3)	boolean	RO			
Pin 6	160	3 (bit offset = 2)	boolean	RO			
Pin 5	160	4 (bit offset = 1)	boolean	RO			
Pin 2	160	5 (bit offset = 1)	boolean	RO			
HW analog (HWA)	161	0	unsigned 16	RO			
PD beam-stream	171	0	array	RO			8 bytes
PD beam-stream	172	0	array	RO			16 bytes
PD beam-stream	173	0	array	RO			32 bytes

Parameter	Index	Sub-index	Data type	Access	Value range	Default	Description
PD beam-stream	174	0	array	RO			64 bytes
PD beam-stream	175	0	array	RO			128 bytes
PD beam-stream	176	0	array	RO			222 bytes
Beam-stream mask	177	0	array	RO			222 bytes

11 Starting up the device - CANopen interface

The configuration of a CANopen interface involves the following steps on the receiver control panel and in the control-specific configuration software.

General prerequisites:

- The measuring light curtain has been mounted (see chapter 6) and connected (see chapter 7) correctly.
- The basic configuration has been performed (see chapter 8).

11.1 Defining the CANopen basic configuration on the receiver control panel

The parameters for the CANopen interface are defined with the node ID and bit rate configurations. The structure of these configurations in the receiver control panel menu is as follows:

Level 0	Level 1	Level 2	Description
Main Settings	Command		
	Operational setting		
	IO-Link		
	CANopen	Node ID	(enter value) min = 1 max = 127
		Bit rate	1000 kbit/s 500 kbit/s 250 kbit/s 125 kbit/s

Prerequisites:

- The measuring light curtain must be correctly aligned (see chapter 8.1).
- The measuring light curtain must be correctly taught (see chapter 8.2).

The following procedure describes the configurations for CANopen interfaces.

↵ Select **Main Settings > CANopen > Node ID > Enter value.**

↵ Select **Main Settings > CANopen > Bit Rate > Enter value.**

The CANopen address (Node ID) and bit rate are configured.

Other possible configuration steps are performed via the *Sensor Studio* configuration software (see chapter 15).

Process mode is configured via the control-specific CANopen interface of the CANopen master.

11.2 Defining configurations via the PLC-specific software of the CANopen master

General prerequisites:

- The measuring light curtain has been mounted (see chapter 6) and connected (see chapter 7) correctly.
- The basic configuration has been performed (see chapter 8).
- The CANopen basic configurations have been performed:
 - CANopen node ID selected
 - CANopen bit rate selected

Specific prerequisites:

- The CANopen-specific EDS file must be installed on the control.



The CANopen device description (EDS file) can be used for direct configuration with connected light curtain.

An EDS file is supplied with the product. It can also be downloaded from the Internet at www.leuze.com.

NOTICE

Configuration dependent on the control-specific software!

- ↪ The sequence of the configurations is dependent on the control-specific software.
- ↪ First configure the EDS file while *off-line*.
- ↪ Once all parameters have been configured, transmit the EDS configurations to the CML 700i.



Information on using the configuration parameters can be found in the general descriptions of the individual functions of the CML 700i (see chapter 4).

- ↪ Open the interface configuration software.
- ↪ Configure the following parameters:
 - Operating mode (parallel-beam; diagonal-beam; crossed-beam scanning)
 - Blanking settings
 - Teach settings
- ↪ Perform a teach. This is possible via the receiver control panel or the control group in the CANopen process data (CANopen object 0x2200).
- ↪ If necessary, configure additional parameter/process data (see chapter 11.3).
- ↪ Save the configuration via the control group in the CANopen process data (CANopen object 0x2200). The CANopen-specific configurations have been performed and the CML 700i is ready for process mode.

11.3 Parameter- / process data for CANopen

The configuration parameters or process data for CANopen is defined via the following object descriptions.

NOTICE

Boundary conditions for object descriptions!

- ↪ Indices 0x1000 ... 0x1FFF contain the standard communication-specific parameters used with CANopen.
- ↪ The product-specific parameters begin with index 0x2000.
- ↪ Communication-specific parameters are automatically persistent.
- ↪ In order for product-specific parameters to be retained following a power down/up, a save command (index 0x2200) is necessary.



The following **abbreviations for data types** apply in the following group descriptions:

- t08U = type 8 bit unsigned integer
- t08S = type 8 bit signed integer
- t16U = type 16 bit unsigned integer
- t16S = type 16 bit signed integer



The following **abbreviations for max. values** apply in the following group descriptions:

- MAX-BEAM = maximum number of beams (max. 1774)
- MAX_T08U = maximum 8 bit unsigned integer
- MAX_T16U = maximum 16 bit unsigned integer
- MAX_T32U = maximum 32 bit unsigned integer

Group overview

Group	Group name
Group 1	CANopen-specific objects (see page 94)
Group 2	Device description (see page 96)
Group 3	General configurations (see page 96)
Group 4	Extended settings (see page 96)
Group 5	Cascading configuration (see page 97)
Group 6	Teach settings (see page 97)
Group 7	Blanking settings (see page 98)
Group 8	Switching level of the inputs/outputs (see page 100)
Group 9	Area configuration (see page 101)
Group 10	Commands (see page 104)
Group 11	Teach status (see page 105)
Group 12	Check the alignment of the light curtains (see page 105)
Group 13	Process data (see page 105)
Group 14	Status (see page 108)

CANopen-specific objects (group 1)

Parameter	Index (hex)	Sub-index (hex)	Data type	Access	Min. value	Max. value	Default	Description
Device type	1000			RO			0	
Error register	1001			RO				
COB-ID-SYNC	1005			RW			0x00000080	
Receiver product designation	1008			CONST				
Hardware version	1009			CONST				
COB-ID-SYNC EMCY	1014			RW				
Firmware version	100A			CONST				
Producer heartbeat time	1017			RW			0	Necessary for heartbeat mechanism
Identity object	1018			RO				
Transmit PDO communication parameter 1	1800			RW				PDO 1 properties
Transmit PDO communication parameter 2	1801			RW				PDO 2 properties
Transmit PDO communication parameter 3	1802			RW				PDO 3 properties
Transmit PDO communication parameter 4	1803			RW				PDO 4 properties
....
Transmit PDO communication parameter 28	181B			RW				PDO 28 properties

Parameter	Index (hex)	Sub-index (hex)	Data type	Access	Min. value	Max. value	Default	Description
Transmit PDO mapping parameter 1	1A00		t32U	RW				Mapped objects in PDO 1
Transmit PDO mapping parameter 2	1A01		t32U	RW				Mapped objects in PDO 2
Transmit PDO mapping parameter 3	1A02		t32U	RW				Mapped objects in PDO 3
Transmit PDO mapping parameter 4	1A03		t32U	RW				Mapped objects in PDO 4
....
Transmit PDO mapping parameter 28	1A1B		t32U	RW				Mapped objects in PDO 28

 The following standard procedure for the TPDO mapping may vary depending on the used configuration software.

Standard procedure for the TPDO mapping:

- ↵ Set the device to the *Preoperational* state.
- ↵ In the desired TPDO Transmit PDO communication parameter 1 ... 28 (objects 0x1800 ... 0x181B), set the COB-ID (sub-index 1) to 0x8000xxx (where the xxx part is node-dependent) and transmit this COB-ID to the device.
This sets the invalid bit, thereby making the TPDO entry invalid.
- ↵ In the desired TPDO Transmit PDO mapping parameter 1 ... 28 (objects 0x1A00 ... 0x1A1B), set the entry for the number of the following elements (sub-index 0, *numOfEntries*) to 0 and transmit this to the device.
An existing mapping is thereby deleted.
- ↵ Then reset this entry to the number of desired mapping elements, whereby a maximum of 4 elements per TPDO are possible.
Transmit this entry back to the device.
- ↵ Set the mapping entries to the desired values. Each of the mapping sub-indices contains a 32-bit value that is structured as follows: SDO object number, sub-index and length. Normally (depending on the used master), the respective settings can be selected from a list.
- ↵ After completing the mapping, transmit the complete TPDO Transmit PDO mapping parameter 1 ... 28 object to the device.
- ↵ In the TPDO Transmit PDO communication parameter 1 ... 28 object (objects 0x1800 ... 0x181B), set the transmission type (sub-index 2 *Transmission type*) and, if applicable, the event timer (sub-index 5, *Event timer*).
- ↵ In the same TPDO object, set the COB-ID (sub-index 1) to 0x0000xxx (where the xxx part is node-dependent) and transmit the complete TPDO object including all sub-indices to the device. This resets the invalid bit, thereby making the TPDO entry valid.
- ↵ Set the device to the *Operational* state.
With operating mode set to *Transmission type*, the device starts to send process data (PDOs).

NOTICE

Boundary conditions for object descriptions!

↵ Beginning with firmware V2.16, no process data settings are automatically stored in non-volatile memory (remanent). The <Save> command is always to be used.

Device description (group 2)



The device characteristics, beginning with index 0x200B, specify the beam spacing, the number of physical/logical individual beams, the number of cascades (16 individual beams) in the device and the cycle time.

Parameter	Index (hex.)	Sub-index (hex.)	Data type	Access	Min. value	Max. value	Default	Description
Manufacturer name	2000			RO				Leuze electronic
Manufacturer text	2001			RO				The sensor people
Receiver part no.	2002			RO				Receiver
Receiver serial number	2003			RO				Receiver
Transmitter product designation	2008			RO				Transmitter
Transmitter part no.	2009			RO				Transmitter
Transmitter serial number	200A			RO				Transmitter
Beam spacing	200B	1	t16U	RO				
Number of physical individual beams	200B	2	t16U	RO				
Number of configured logical cascades	200B	3	t16U	RO				With parallel scanning, the number of logical individual beams corresponds to the number of physical individual beams; with diagonal scanning, this number is doubled.
Number of optical cascades	200B	4	t16U	RO				
Device cycle time [µs]	200B	5	t16U	RO				Duration for a complete measurement cycle (measurement cycle for one measurement); minimum time is 1 ms.

General configurations (group 3)



Configured in group 3 “General configurations” are the type of scanning (parallel-/diagonal-/crossed-beam), counting direction and minimum object size for the evaluation (smoothing). The minimum hole size for the evaluation, e.g., with web material, is configured via inverted smoothing.

Parameter	Index (hex.)	Sub-index (hex.)	Data type	Access	Min. value	Max. value	Default	Description
Mode	2100	1	t08U	RW	0	2	0	0: Parallel-beam scanning 1: Diagonal-beam scanning 2: Crossed-beam scanning
Counting direction	2100	2	t08U	RW	0	1	0	0: Normal – beginning at the connection side 1: Inverted – beginning opposite the connection side
Smoothing	2100	3	t08U	RW	1	MAX_T08U	1	Less than i interrupted beams are ignored
Smoothing inverted	2100	4	t08U	RW	1	MAX_T08U	1	Less than i free beams are ignored

Extended settings (group 4)



The filter depth indicates the necessary number of consistent beam states before the evaluation of the measurement values.

All measurement values are accumulated and retained over the duration of the integration time.

Parameter	Index (hex.)	Sub-index (hex.)	Data type	Access	Min. value	Max. value	Default	Description
	2101	1	t08U	RO	0			Reserved
Filter Depth	2101	2	t08U	RW	0	MAX_T08U	1	The necessary number of consistent beam states before the evaluation of the measurement values.
Integration/hold time	2101	3	t16U	RW	0	MAX_T16U	0	Hold function in ms All measurement values are accumulated and retained over the duration of the integration time.
Button lock and display	2106		t08U	RW	0	2	0	Lock operational controls on the device. 0: Enabled 1: Locked 2: Temporary

Cascading configuration (group 5)



To prevent mutual interference, multiple light curtains can be operated with a time offset with respect to one another (cascade). Here, the master generates the cyclical trigger signal; the slaves start their measurement after delay times, which are to be set to different values.

Parameter	Index (hex.)	Sub-index (hex.)	Data type	Access	Min. value	Max. value	Default	Description
Cascading	2102	1	t08U	RW		1	0	0: Not active (constant measurement of the sensor) 1: Active (sensor expects trigger signal) Notice: With cascading operation, the master must also be set to 1 (active)!
Function type	2102	2	t08U	RW		1	0	0: Slave (expects trigger signal) 1: Master (sends trigger signal)
Trigger delay time → Start of the measurement	2102	3	t16U	RW		MAX_T16U	500	Delay time in µs (from rising edge at TRIGGER until start of measurement cycle)
Reserved	2102	4	t16U					
Master cycle time	2102	5	t16U	RW		6500	1	Duration of a TRIGGER_cycle in ms

Teach settings (group 6)



In most applications, it is recommended that the teach values be stored in non-volatile memory.

Depending on the function reserve selected for the teach event, the sensitivity is higher or lower (high function reserve = low sensitivity; low function reserve = high sensitivity).

Parameter	Index (hex.)	Sub-index (hex.)	Data type	Access	Min. value	Max. value	Default	Description
Number of teach cycles	2103	1	t08U	RO			10	Depending on the environmental conditions or application, the light curtain may have completed multiple cycles after the triggering of a teach.
Type of storage for teach values	2103	2	t08U	RW	0	1	0	0: Non-volatile storage of teach values 1: Teach values stored only while voltage is ON
Sensitivity adjustment for teach event	2103	3	t08U	RW	0	3	0	Sensitivity of the measurement system: 0: High function reserve (for stable operation) 1: Medium function reserve 2: Low function reserve 3: Transparent media
Switching threshold	2103	4	t08U	RW	10	98	75	Threshold as percentage of teach threshold (50% = function reserve 2)
Teach status	2400	1	t08S	RO	0	MAX_T08U		Information about the last teach: 00: Teach ok 01: Teach busy 80: Teach error (bit 8 = error bit)

Blanking settings (group 7)



Up to four beam areas can be deactivated. Deactivated beams can be assigned the logical values 0, 1 or the value of the adjacent beam. With auto blanking activated, up to four beam areas are automatically suppressed during teaching.

Auto blanking should only be activated during commissioning of the CML 700i to suppress interfering objects. In process mode, auto blanking should be deactivated.

For details on this topic see chapter 14.4.

NOTICE
Perform teach after changing the blanking configuration!
<p>↪ Perform a teach after changing the blanking configuration.</p> <p>A teach can be performed via the receiver control panel or via the teach command.</p>

Parameter	Index (hex.)	Sub-index (hex.)	Data type	Access	Min. value	Max. value	Default	Description
Number of auto-blanking areas	2104	1	t08U	RW	0	4	0	Permissible number of auto-blanking areas 0: 0 auto-blanking areas 1: 1 auto-blanking area 2: 2 auto-blanking areas 3: 3 auto-blanking areas 4: 4 auto-blanking areas
Auto blanking (during teaching)	2104	2	t08U	RW	0	1	0	0: Not active (manual blanking area configuration) 1: Active (automatic blanking area configuration through teach)
Function for blanking area 1	2104	3	t16U	RW	0	4	0	0: No beams blanked 1: Logical value 0 for blanked beams 2: Logical value 1 for blanked beams 3: Logical value = same as adjacent beam with lower beam number 4: Logical value = same as adjacent beam with higher beam number
Start beam of blanking area 1	2104	4	t16U	RW	1	MAX_BEAM	1	Start beam of the blanking area
End beam of blanking area 1	2104	5	t16U	RW	1	MAX_BEAM	1	End beam of the blanking area
Function for blanking area 2	2104	6	t16U	RW	0	4	0	0: No beams blanked 1: Logical value 0 for blanked beams 2: Logical value 1 for blanked beams 3: Logical value = same as adjacent beam with lower beam number 4: Logical value = same as adjacent beam with higher beam number
Start beam of blanking area 2	2104	7	t16U	RW	1	MAX_BEAM	1	Start beam of the blanking area
End beam of blanking area 2	2104	8	t16U	RW	1	MAX_BEAM	1	End beam of the blanking area
Function for blanking area 3	2104	9	t16U	RW	0	4	0	0: No beams blanked 1: Logical value 0 for blanked beams 2: Logical value 1 for blanked beams 3: Logical value = same as adjacent beam with lower beam number 4: Logical value = same as adjacent beam with higher beam number
Start beam of blanking area 3	2104	A	t16U	RW	1	MAX_BEAM	1	Start beam of the blanking area
End beam of blanking area 3	2104	B	t16U	RW	1	MAX_BEAM	1	End beam of the blanking area

Parameter	Index (hex.)	Sub-index (hex.)	Data type	Access	Min. value	Max. value	Default	Description
Function for blanking area 4	2104	C	t16U	RW	0	4	0	0: No beams blanked 1: Logical value 0 for blanked beams 2: Logical value 1 for blanked beams 3: Logical value = same as adjacent beam with lower beam number 4: Logical value = same as adjacent beam with higher beam number
Start beam of blanking area 4	2104	D	t16U	RW	1	MAX_BEAM	1	Start beam of the blanking area
End beam of blanking area 4	2104	E	t16U	RW	1	MAX_BEAM	1	End beam of the blanking area

Switching level of the inputs/outputs (group 8)



The inputs/outputs can be set to positive switching (PNP) or to negative switching (NPN). The switching behavior applies the same for all inputs/outputs.

For details on this topic see chapter 14.

Parameter	Index (hex.)	Sub-index (hex.)	Data type	Access	Min. value	Max. value	Default	Description
Type of level	2150		Bool	RW	0	1	1	0: NPN 1: PNP



Configuration of the inputs/outputs: pin 2 and/or pin 5.

Parameter	Index (hex.)	Sub-index (hex.)	Data type	Access	Min. value	Max. value	Default	Description
Configuration of pin 2								
Pin 2: Output function	2151	1	t08U	RW	0	3	0	0: Not active 1: Switching output (area 1 ... 32) 2: Warning output 3: Trigger output
Pin 2: Input function	2151	2	t08U	RW	0	2	2	0: Not active 1: Trigger input 2: Teach input
Pin 2: Switching behavior	2151	3	t08U	RW	0	1	0	0: Normal - light switching 1: Inverted - dark switching
Pin 2: Input/output selection	2151	4	t08U	RW	0	1	1	0: Output 1: Input
Configuration of pin 5								
Pin 5: Output function	2152	1	t08U	RW	0	3	0	0: Not active 1: Switching output (area 1 ... 32) 2: Warning output 3: Trigger output

Parameter	Index (hex.)	Sub-index (hex.)	Data type	Access	Min. value	Max. value	Default	Description
Pin 5: Input function	2152	2	t08U	RW	0	2	1	0: Not active 1: Trigger input 2: Teach input
Pin 5: Switching behavior	2152	3	t08U	RW	0	1	0	0: Normal - light switching 1: Inverted - dark switching
Pin 5: Input/output selection	2152	4	t08U	RW	0	1	1	0: Output 1: Input

Procedure for the four time ranges:

Four different time functions can be set; the maximum duration that can be set is 65 s.

Mapping of the area 1 ... 32 to output pin 2 = index 0x2155 sub 3 or index 0x2156 sub 3 for pin 5.

↪ Activate the area by entering a 1 at the corresponding position in the 32-bit word. Area 1 ... 32 increasing from right.



For details on this topic see chapter 14.

Parameter	Index (hex.)	Sub-index (hex.)	Data type	Access	Min. value	Max. value	Default	Description
Digital Output Pin 2 Settings								
Operating mode of the time module	2155	1	t08U	RW	0	4	0	0: Not active 1: Start-up delay 2: Switch-off delay 3: Pulse stretching 4: Pulse suppression
Delay time for selected function	2155	2	t16U	RW	0	MAX_T16U	0	0 ... 65535 ms
Area mapping 32 ... 1	2155	3	t32U	RW	0	MAX_T32U	0	Logical OR link mask of the switching outputs
Digital Output Pin 5 Settings								
Operating mode of the time module	2156	1	t08U	RW	0	4	0	0: Not active 1: Start-up delay 2: Switch-off delay 3: Pulse stretching 4: Pulse suppression
Delay time for selected function	2156	2	t16U	RW	0	MAX_T16U	0	0 ... 65535 ms
Area mapping 32 ... 1	2156	3	t32U	RW	0	MAX_T32U	0	Logical OR link mask of the switching outputs

Area configuration (group 9)

Procedure for manual area splitting of the maximum 32 areas:

↪ Definition of the status conditions so that the area takes on a logical 1 or 0.

For diagonal- or crossed-beam mode, the numbers of the logical beams are to be entered.



For details on this topic see chapter 14.

Parameter	Index (hex.)	Sub-index (hex.)	Data type	Access	Min. value	Max. value	Default	Description
Configuration of area 1	2170							
Area	2170	1	t08U	RW	0	1	0	0: Not active 1: Active
Logical behavior of the area	2170	2	t08U	RW	0	1	0	0: Normal - light switching 1: Inverted - dark switching
Start beam of the area	2170	3	t16U	RW	1	FFFE	1	1 ... 1774 65534: First interrupted beam (FIB) 65533: First uninterrupted beam (FNIB) 65532: Last interrupted beam (LIB) 65531: Last uninterrupted beam (LNIB)
End beam of the area	2170	4	t16U	RW	1	FFFE	1	1 ... 1774 65534: First interrupted beam (FIB) 65533: First uninterrupted beam (FNIB) 65532: Last interrupted beam (LIB) 65531: Last uninterrupted beam (LNIB)
Number of active beams for area ON	2170	5	t16U	RW	0	MAX_BEAM	0	0 ... 1774
Number of active beams for area OFF	2170	6	t16U	RW	0	MAX_BEAM	0	0 ... 1774
Specified middle of the area	2170	7	t16U	RW	0	MAX_BEAM	0	0 ... 1774
Specified width of the area	2170	8	t16U	RW	0	MAX_BEAM	0	0 ... 1774
Configuration of area 2	2171							
Area	2171	1	t08U	RW	0	1	0	0: Not active 1: Active
Logical behavior of the area	2171	2	t08U	RW	0	1	0	0: Normal - light switching 1: Inverted - dark switching
Start beam of the area	2171	3	t16U	RW	1	FFFE	1	1 ... 1774 65534: First interrupted beam (FIB) 65533: First uninterrupted beam (FNIB) 65532: Last interrupted beam (LIB) 65531: Last uninterrupted beam (LNIB)
End beam of the area	2171	4	t16U	RW	1	FFFE	1	1 ... 1774 65534: First interrupted beam (FIB) 65533: First uninterrupted beam (FNIB) 65532: Last interrupted beam (LIB) 65531: Last uninterrupted beam (LNIB)
Number of active beams for area ON	2171	5	t16U	RW	0	MAX_BEAM	0	0 ... 1774
Number of active beams for area OFF	2171	6	t16U	RW	0	MAX_BEAM	0	0 ... 1774
Specified middle of the area	2171	7	t16U	RW	0	MAX_BEAM	0	0 ... 1774
Specified width of the area	2171	8	t16U	RW	0	MAX_BEAM	0	0 ... 1774
All other 30 areas are configured in the same way as described for 2170 and 2171:								

Parameter	Index (hex.)	Sub-index (hex.)	Data type	Access	Min. value	Max. value	Default	Description
Configuration of area 3	2172							
Configuration of area 4	2173							
Configuration of area 5	2174							
Configuration of area 6	2175							
Configuration of area 7	2176							
Configuration of area 8	2177							
Configuration of area 9	2178							
Configuration of area 10	2179							
Configuration of area 11	217A							
Configuration of area 12	217B							
Configuration of area 13	217C							
Configuration of area 14	217D							
Configuration of area 15	217E							
Configuration of area 16	217F							
Configuration of area 17	2180							
Configuration of area 18	2181							
Configuration of area 19	2182							
Configuration of area 20	2183							
Configuration of area 21	2184							
Configuration of area 22	2185							
Configuration of area 23	2186							
Configuration of area 24	2187							
Configuration of area 25	2188							
Configuration of area 26	2189							
Configuration of area 27	218A							
Configuration of area 28	218B							
Configuration of area 29	218C							
Configuration of area 30	218D							
Configuration of area 31	218E							
Configuration of area 32	218F							

Commands (group 10)

Procedure for "automatic" area splitting:

- ↵ Send the desired number of areas to the command argument (index 0x2200, sub 2).
- ↵ Perform area splitting: set command argument (index 0x2200, sub 1) to value 8.



For all commands, first the command argument must be written and then the command identifier.

Parameter	Index (hex.)	Sub-index (hex.)	Data type	Access	Min. value	Max. value	Default	Description
Command Identifier	2200	1	t16U	WO				Command to be executed for write access 0: Reserved 1: Reserved 3: Teach 4: Reboot 5: Reset Note Reset deletes the user settings. On the next PowerOn, the factory settings are applied. To reset to factory settings, a reboot must follow a reset. 6: Save Notice: Processing of the Save command takes up to 600 ms. During this time, no other data/telegrams are accepted. 7: Reserved 8: Splitting, division of the evaluation areas
Command argument	2200	2	t16U	WO				Argument for command 8 (splitting): Into how many areas should the beams be split? Number of areas 1 ... i Enter value (max. 32): 1: i = 1: All beams of the light curtain form one area 2: i = 2: Beams are split into 2 equally large areas 3: i = 3: Beams are split into 3 equally large areas, etc. (bit 0 ... 7) Notice on splitting: The result of the splitting function is written in the <i>Configuration of area ...</i> objects with indices 2170 ... 218F. 0: Area result active if a beam is interrupted (AND) 1: Area result active if all beams are interrupted (OR) (bit 8)

Teach status (group 11)

Parameter	Index (hex.)	Sub-index (hex.)	Data type	Access	Min. value	Max. value	Default	Description
Teach status	2400	1	t08U	RO		MAX_T08U		Information about the last teach event: 00: Teach ok 01: Teach busy 80: Teach error (bit 8 = error bit)
Status/state of a beam	2191		t08U	RO	0	255		Reading out of the switch-on thresholds of the individual beams. Notice: The data can be read for 64 beams. The first beam of this block output is selected via the "index section access - only for additional beam data" (0x2912).
Status/state of a beam	2192		t08U	RO	0	255		Reading out of the switch-off thresholds of the individual beams. Notice: The data can be read for 64 beams. The first beam of this block output is selected via the "index for block access for the extended beam data" (0x2912).
Index for block access (for the extended beam data)	2912		t08U	RO	1	1774	1	Defines the first logical beam for the evaluation of extended beam data.

Check the alignment of the light curtains (group 12)



Information on the signal level of the first and last beam.

The value changes depending on the selected function reserve.

Parameter	Index (hex.)	Sub-index (hex.)	Data type	Access	Min. value	Max. value	Default	Description
Signal level of first beam	2404	1	t16U	RO				Signal level on beam no. 1
Signal level of last beam	2404	2	t16U	RO				Signal level on beam no. i

Process data (group 13)



Configuration of the process data:

- First interrupted/uninterrupted beam (FIB/FNIB),
- Last interrupted/uninterrupted beam (LIB/LNIB),
- Number of interrupted/uninterrupted beams (TIB/TNIB);
- Area Out 1 ... 16 or 17 ... 32; digital inputs/outputs

Parameter	Index (hex.)	Sub-index (hex.)	Data type	Access	Min. value	Max. value	Default	Description
First interrupted beam (FIB)	2405		t16U	RO				First interrupted beam
First uninterrupted beam (FNIB)	2406		t16U	RO				First uninterrupted beam
Last interrupted beam (LIB)	2407		t16U	RO				Last interrupted beam
Last uninterrupted beam (LNIB)	2408		t16U	RO				Last uninterrupted beam
Number of interrupted beams (TIB)	2409		t16U	RO				Sum of interrupted beams
Number of uninterrupted beams (TNIB)	240A		t16U	RO				Sum of uninterrupted beams
Area Out - LoWord	240D		t16U	RO				Logical value of areas 1 ... 16
Area Out - HiWord	240E		t16U	RO				Logical value of areas 17 ... 32
Status of the digital inputs/outputs	240F		t16U	RO				Representation of the hardware switching outputs; these are mapped to the areas
CML 700i status information	2411		t16U	RO				Bits 0 ... 11: measurement cycle number of a measurement; Bits 12 ... 13: reserved; Bit 14: 1 = event (is set if the status changes) Cause/reason for event can be seen in index 2162. Bit 15: 1 = valid measurement result exists

Parameter	Index (hex.)	Sub-index (hex.)	Data type	Access	Min. value	Max. value	Default	Description
Beam-stream	2412	1	t16U	RO				Reading out of the beam states of all existing individual beams: One bit per interrupted or uninterrupted beam in inverted operation (i.e., bit i = 1 corresponds to "light path is free"). An object contains 16 individual beams, i.e., beam i to (i+15). <hr/> Read out beam 1 ... 16
		2	t16U	RO				Read out beam 17 ... 32
		3	t16U	RO				Read out beam 33 ... 48
	
		6F	t16U	RO				Read out beam 1761 ... 1774
Status/state of a beam	2402		t18U	RO				Reading out the beams states according to the blanking settings: 0: Beam is interrupted; no blanking settings 1: Beam is interrupted; blanking setting: beam = 0 (interrupted) 2: Beam is interrupted; blanking setting: beam = 1 (free light path) 3: Beam is interrupted; blanking setting: suppressed beam = adjacent beam with smaller beam number 4: Beam is interrupted; blanking setting: suppressed beam = adjacent beam with larger beam number 128: Free light path; no blanking settings 129: Free light path; blanking setting: beam = 0 (interrupted) 130: Free light path; blanking setting: beam = 1 (free light path) 131: Free light path; blanking setting: suppressed beam = adjacent beam with smaller beam number 132: Free light path; blanking setting: suppressed beam = adjacent beam with larger beam number Notice: The data can be read for 64 beams. The first beam of this block output is selected via the "index for block access for the extended beam data" (0x2912).
Index for block access (for the extended beam data)	2912		t16U	RW	1	1774	1	Defines the first logical beam for the evaluation of extended beam data.

Status (group 14)



Information on the status of the light curtain.

Parameter	Index (hex.)	Sub-index	Data type	Access	Min. value	Max. value	Default	Description
Device status	2162		t16S	RO				0: Normal function 1: Teaching error 2: Internal temperature/voltage monitoring 3: Invalid configuration 4: Hardware error 5: 24 V voltage error (supply voltage U _B) 6: Transmitter and receiver incompatible 7: No connection to transmitter 8: Soiling 9: Teaching necessary 10: Measurement not active. The device <ul style="list-style-type: none"> • reconfigures itself • (re)starts • waits for the first trigger pulse • was manually stopped
R _x error field	2600		t16U	RO				For internal diagnosis only
K _x error field	2601		t16U	RO				For internal diagnosis only

12 Starting up the device - Profibus interface

The configuration of a Profibus interface involves the following steps on the receiver control panel and in the control-specific configuration software.

General prerequisites:

- The measuring light curtain has been mounted (see chapter 6) and connected (see chapter 7) correctly.
- The basic configuration has been performed (see chapter 8).

12.1 Defining the Profibus basic configuration on the receiver control panel

The parameters for the Profibus interface are defined with the slave address and bit rate configurations. The structure of these configurations in the receiver control panel menu is as follows:

Level 0	Level 1	Level 2	Description
Main Settings	Command		
	Operational setting		
	IO-Link		
	Profibus	Slave address	(enter value) min = 1 max = 126
		Bit rate	3000 kbit/s 1500 kbit/s 500 kbit/s 187.5 kbit/s 93.75 kbit/s 45.45 kbit/s 19.2 kbit/s 9.6 kbit/s

Prerequisites:

- The measuring light curtain must be correctly aligned (see chapter 8.1).
- The measuring light curtain must be correctly taught (see chapter 8.2).

The following procedure describes the configurations for Profibus interfaces.

↵ Select **Main Settings > Profibus > Slave Address > Enter value.**

↵ Select **Main Settings > Profibus > Bit rate > Enter value.**

The bus address and bit rate are configured.

Other possible configuration steps are performed via the *Sensor Studio* configuration software (see chapter 15).

Process mode is configured via the control-specific Profibus interface.

12.2 Defining configurations via the PLC-specific software

General prerequisites:

- The measuring light curtain has been mounted (see chapter 6) and connected (see chapter 7) correctly.
- The basic configuration has been performed (see chapter 8).
- The Profibus basic configurations have been performed:
 - **Slave address** selected
 - **Bit rate** selected

Specific prerequisites:

- The Profibus-specific GSD file must be installed on the control.



The Profibus device master data file (GSD) can be used both with connected light curtain for direct configuration as well as “off-line” without connected CML 700i for creating device configurations.

The GSD file is supplied with the product. It can also be downloaded from the Internet at www.leuze.com.

NOTICE

Configuration dependent on the control-specific software!

- ↪ The sequence of the configurations is dependent on the control-specific software.
- ↪ First configure the GSD file while *off-line*
- ↪ Once all parameters have been configured, transmit the GSD configuration to the CML 700i.



Information on using the configuration parameters can be found in the general descriptions of the individual functions of the CML 700i (see chapter 4).

- ↪ Open the interface software.
- ↪ Configure the following parameters:
 - Beam mode (parallel-beam, diagonal-beam, crossed-beam scanning)
 - Blanking settings
 - Teach settings
- ↪ Perform a teach. This is possible via the receiver control panel or the control module in the Profibus process data.
- ↪ If necessary, configure additional parameter/process data (see chapter 12.3.2).



The configuration does not need to be stored separately, but is rather automatically transferred from the control to the CML 700i on machine start-up.

The Profibus-specific configurations have been performed and the CML 700i is ready for process mode.

12.3 Parameter/process data for Profibus

12.3.1 General information on Profibus

In addition to the basic configurations (see chapter 8), the functionality of the CML 700i is defined via the GSD modules. The necessary modules are linked and appropriately configured for the given measurement application with a user-specific PLC configuration software program.



During operation of the CML 700i on the Profibus, all configuration parameters are set with adjustment values ex works (see default adjustment values in the following module descriptions). As long as these configuration parameters are not changed, the CML 700i operates with these default parameter values.

NOTICE

Working with the GSD file modules!

- ↪ At least one module must be configured with input data from the GSD file in the control-specific configuration software, e.g., module 1 “evaluation functions (16 bit)”.
- ↪ Some programmable logic controls make available a so-called “universal module”. This module is used for control purposes and must not be activated for the CML 700i.

12.3.2 Configuration parameters or process data

The configuration parameters or process data for Profibus is defined via the following module descriptions.

Module overview

Module no.	Module name	ID (hex)	Parameter	Inputs	Outputs
Module 0	Sensor control module (see page 111)	C0	0	0	2
Module 1	Evaluation functions (16 bit) (see page 112)	F0	1	2	0
Module 2	Beam-stream (16 bit) (see page 112)	B0	1	2	0
Module 3	Beam-stream (32 bit) (see page 112)	B1	1	4	0
Module 4	Beam-stream (64 bit) (see page 113)	B2	1	8	0
Module 5	Beam-stream (128 bit) (see page 113)	B3	1	16	0
Module 6	Beam-stream (256 bit) (see page 113)	B4	1	32	0
Module 7	Beam-stream (512 bit) (see page 113)	B5	1	64	0
Module 8	Beam-stream (1024 bit) (see page 113)	B6	1	128	0
Module 9	Beam-stream (1774 bit) (see page 114)	B7	0	222	0
Module 10	Read device parameters (see page 114)	E0	1	0	0
Module 11	General settings (see page 115)	D0	3	0	0
Module 12	Extended settings (see page 115)	D1	4	0	0
Module 13	Configuration of digital I/Os (see page 115)	D2	16	0	0
Module 14	Teach settings (see page 117)	D3	3	0	0
Module 15	Cascading configuration (see page 117)	D4	7	0	0
Module 16	Blanking configuration (see page 117)	D6	21	0	0
Module 17	Autosplitting configuration (see page 118)	D7	1	0	0
Module 18	Area settings (see page 119)	D8	13	0	0

Sensor control module (module 0)



The sensor control module allows to control the CML 700i via the process data with byte 1 and byte 2. In both cases, the command is triggered in the device by incrementing the data value.

Parameter	Rel. Adr.	Data type	Value range	Default	Description
Sensor control module			Trigger = byte 1 Teach = byte 2		

Evaluation function (16 bit) (module 1)



- Configuration of the process data module (16 bit):
- First interrupted/uninterrupted beam (FIB/FNIB),
 - Last interrupted/uninterrupted beam (LIB/LNIB),
 - Number of interrupted/uninterrupted beams (TIB/TNIB);
 - Status area 1 ... 32

Parameter	Rel. Adr.	Data type	Value range	Default	Description
Evaluation function	0	Unsigned16	0 ... 13	0	Process data module (16 bit) 0: No evaluation (NOP) 1: 1st interrupted beam 2: 1st uninterrupted beam 3: Last interrupted beam 4: Last uninterrupted beam 5: Number of interrupted beams 6: Number of uninterrupted beams 9: Status of beam area 16 ... 1 10: Status of beam area 32 ... 17 11: Status digital inputs/outputs 12: Reserved 13: CML 700i status information <ul style="list-style-type: none"> • Bits 0 ... 11: measurement cycle number of a measurement • Bits 12 ... 13: reserved • Bit 14: 1 = event (is set if the status changes) Cause/reason for event can be seen in index 2162. • Bit 15: 1 = valid measurement result exists



To set different evaluation functions, you must configure the same module multiple times.

Beam-stream (16 bit) (module 2)



Reading out of the beam states of all existing individual beams. The object transmits 16 logical beams beginning with the configured optical cascade. One bit is transmitted for each interrupted or uninterrupted beam.

Parameter	Rel. Adr.	Data type	Value range	Default	Description
Number of the optical cascade	0	Unsigned16	1 ... 111	1	Number of the optical cascade beginning with which the beam-stream data is to be transmitted.

Beam-stream (32 bit) (module 3)



Reading out of the beam states of all existing individual beams. The object transmits 32 logical beams beginning with the configured optical cascade. One bit is transmitted for each interrupted or uninterrupted beam.

Parameter	Rel. Adr.	Data type	Value range	Default	Description
Number of the optical cascade	0	Unsigned32	1 ... 110	1	Number of the optical cascade beginning with which the beam-stream data is to be transmitted.

Beam-stream (64 bit) (module 4)



Reading out of the beam states of all existing individual beams. The object transmits 64 logical beams beginning with the configured optical cascade. One bit is transmitted for each interrupted or uninterrupted beam.

Parameter	Rel. Adr.	Data type	Value range	Default	Description
Number of the optical cascade	0	Unsigned64	1 ... 108	1	Number of the optical cascade beginning with which the beam-stream data is to be transmitted.

Beam-stream (128 bit) (module 5)



Reading out of the beam states of all existing individual beams. The object transmits 128 logical beams beginning with the configured optical cascade. One bit is transmitted for each interrupted or uninterrupted beam.

Parameter	Rel. Adr.	Data type	Value range	Default	Description
Number of the optical cascade	0	Unsigned128	1 ... 104	1	Number of the optical cascade beginning with which the beam-stream data is to be transmitted.

Beam-stream (256 bit) (module 6)



Reading out of the beam states of all existing individual beams. The object transmits 256 logical beams beginning with the configured optical cascade. One bit is transmitted for each interrupted or uninterrupted beam.

Parameter	Rel. addr.	Data type	Value range	Default	Description
Number of the optical cascade	0	Unsigned256	1 ... 96	1	Number of the optical cascade beginning with which the beam-stream data is to be transmitted.

Beam-stream (512 bit) (module 7)



Reading out of the beam states of all existing individual beams. The object transmits 512 logical beams beginning with the configured optical cascade. One bit is transmitted for each interrupted or uninterrupted beam.

Parameter	Rel. Adr.	Data type	Value range	Default	Description
Number of the optical cascade	0	Unsigned512	1 ... 80	1	Number of the optical cascade beginning with which the beam-stream data is to be transmitted.

Beam-stream (1024 bit) (module 8)



Reading out of the beam states of all existing individual beams. The object transmits 1024 logical beams beginning with the configured optical cascade. One bit is transmitted for each interrupted or uninterrupted beam.

Parameter	Rel. Adr.	Data type	Value range	Default	Description
Number of the optical cascade	0	Unsigned1024	1 ... 48	1	Number of the optical cascade beginning with which the beam-stream data is to be transmitted.

Beam-stream (1774 bit) (module 9)



Reading out of the beam states of all existing individual beams. The object transmits 1774 logical beams beginning with the configured optical cascade. One bit is transmitted for each interrupted or uninterrupted beam.

Parameter	Rel. Adr.	Data type	Value range	Default	Description
Number of the optical cascade	0	Unsigned1774	1	1	Number of the optical cascade beginning with which the beam-stream data is to be transmitted.

Read device parameters (module 10)



With the “Read device parameters” module, various data (e.g., manufacturer, device type, serial number, etc.) can be read out for diagnostics or to check the configuration during the start-up phase.

Parameter	Rel. Adr.	Data type	Value range	Default	Description
Parameter	0	Unsigned8 0 ... 255	0 ... 161	0	0: ZERO 16: Manufacturer 17: Manufacturer text 18: Receiver product designation 19: Receiver part no. 20: Product description 21: Receiver serial number 22: Hardware version 23: Firmware version 24: Application-specific name 64: Transmitter product designation 65: Transmitter part no. 66: Transmitter serial number 67: Device description 68: Teach status 69: Status - alignment 70: General settings 71: Process data configuration 72: Cascading configuration 73: Extended settings 75: Blanking area configuration 76: Digital PNP/NPN 80: Digital IO 01 81: Digital IO 02 82: Digital IO 03 83: Digital IO 04 84: Digital output 01 85: Digital output 02 86: Digital output 03 87: Digital output 04 88: Analog output configuration 89: Analog function 100: Area 01 101: Area 02 102: Area 03 ... 129: Area 30 130: Area 31 131: Area 32 150: 1st interrupted beam 151: 1st uninterrupted beam 152: Last interrupted beam 153: Last uninterrupted beam 154: Number of interrupted beams 155: Number of uninterrupted beams 158: Status of areas 16 ... 1 159: Status of areas 32 ... 17 160: Status of digital inputs/outputs 161: Status of analog output

General settings (module 11)



Under general settings, the type of scanning (parallel-/diagonal-/crossed-beam), counting direction and minimum object for evaluation (smoothing) or minimum hole size (inverted smoothing) are set.

Parameter	Rel. Adr.	Data type	Value range	Default	Description
Mode	0	BitArea(4 ... 7) 0 ... 3	0 ... 2	0	0: Parallel-beam scanning 1: Diagonal-beam scanning 2: Crossed-beam scanning
Counting direction	0	Bit(0) 0 ... 1	0 ... 1	0	0: Normal (interface →) 1: Inverted (→ interface)
Smoothing	1	Unsigned8	1 ... 255	1	Smoothing: Less than i interrupted beams are ignored.
Inverted smoothing	2	Unsigned8	1 ... 255	1	Inverted smoothing: Less than i free beams are ignored.

Extended settings (module 12)



The filter depth indicates the necessary number of consistent beam states before the evaluation of the measurement values. All measurement values are accumulated and retained over the duration of the integration time.

Parameter	Rel. Adr.	Data type	Value range	Default	Description
Autoteach on power-on	0	Bit (7) 0 ... 1	0 ... 1	0	Automatic teach on power-on 0: Not active 1: Active
Button lock on the display	0	Bit(0) 0 ... 1	0 ... 1	0	0: Not active 1: Active
Filter Depth	1	Unsigned8	1 ... 255	1	The filter depth indicates the necessary number of consistent beam states before the evaluation of the measurement values. The filter depth corresponds to the number of passes (measurement cycles) with interrupted beam so that the result leads to switching.
Integration/hold time	2	Unsigned16	1 ... 65535	1	All measurement values are accumulated and retained over the duration of the integration time. Hold function in ms.

Configuration of digital IOs (module 13)



Configuration of the inputs/outputs. The inputs/outputs can be set to positive switching (PNP) or to negative switching (NPN). The switching behavior applies the same for all inputs/outputs.

Parameter	Rel. Adr.	Data type	Value range	Default	Description
Switching level of digital I/Os	0	Bit (7) 0 ... 1	0 ... 1	1	0: Transistor, NPN 1: Transistor, PNP



Configuration of the inputs/outputs: pin 2 and/or pin 5.

Teach settings (module 14)



In most applications, it is recommended that the teach values be stored in non-volatile memory.

Depending on the function reserve selected for the teach, the sensitivity is higher or lower (high function reserve = low sensitivity, low function reserve = high sensitivity).

Parameter	Rel. Adr.	Data type	Value range	Default	Description
Type of storage for teach values	0	BitArea(4 ... 7) 0-1	0 ... 1	0	0: Non-volatile storage 1: Teach values stored only in RAM
Sensitivity adjustment for teach event	0	BitArea(0 ... 3) 0 ... 3	0 ... 3	0	Sensitivity of the measurement system: 0: High function reserve (for stable operation) 1: Medium function reserve 2: Low function reserve 3: Transparent media
Number of teach cycles	1	Unsigned8	1 ... 255	1	
Switching threshold after teach	2	Unsigned8	10 ... 98	75	Only when "detecting transparent media"

Cascading configuration (module 15)



To prevent mutual interference, multiple CML 700i can be operated with a time offset with respect to one another (cascade). Here, the master generates the cyclical trigger signal; the slaves start their measurement after delay times, which are to be set to different values.

Parameter	Rel. Adr.	Data type	Value range	Default	Description
Cascading	0	Bit (7) 0 ... 1	0 ... 1	0	0: Not active 1: Active
Function type	0	Bit(0) 0 ..1	0 ... 1	0	0: Slave (expects trigger signal) 1: Master (sends trigger signal)
Delay time Trigger → Scan	1	Unsigned16	500 ... 65535	500	Unit: µs
Pulse width of trigger signal	3	Unsigned16	100 ... 65535	100	Unit: µs
Master cycle time	5	Unsigned16	1 ... 6500	1	Unit: ms

Blanking configuration (module 16)



Up to four beam areas can be suppressed. Deactivated beams can be assigned the logical values 0, 1 or the value of the adjacent beam. With auto blanking activated, up to four beam areas are automatically suppressed during teaching.

Auto blanking should only be activated during commissioning of the CML 700i to suppress interfering objects. In process mode, auto blanking should be deactivated.

For details on this topic see chapter 14.4.

NOTICE

Perform teach after changing the blanking configuration!

👉 Perform a teach after changing the blanking configuration.

A teach can be performed via the receiver control panel or via the teach command.

Parameter	Rel. Adr.	Data type	Value range	Default	Description
Number of auto-blanking areas	0	BitArea(4 ... 7) 0 ... 4	0 ... 4	0	Permissible number of blanking areas 0: 0 auto-blanking areas 1: 1 auto-blanking area 2: 2 auto-blanking areas 3: 3 auto-blanking areas 4: 4 auto-blanking areas
Auto blanking (during teaching)	0	Bit(0) 0 ... 1	0 ... 1	0	0: Not active (manual blanking area configuration) 1: Active (automatic blanking area configuration through teach)
Log. value for blanking area 1	1	BitArea(4 ... 7) 0 ... 4	0 ... 4	0	0: No beams blanked 1: Blanked beams = log. 0 2: Blanked beams = log. 1 3: Value = lower-value neighbor 4: Value = higher-value neighbor
Start beam of blanking area 1	2	Unsigned16	1 ... 1774	1	
End beam of blanking area 1	4	Unsigned16	1 ... 1774	1	
Log. value for blanking area 2	6	BitArea(0 ... 3) 0 ... 4.	0 ... 4	0	0: No beams blanked 1: Blanked beams = log. 0 2: Blanked beams = log. 1 3: Value = lower-value neighbor 4: Value = higher-value neighbor
Start beam of blanking area 2	7	Unsigned16	1 ... 1774	1	
End beam of blanking area 2	9	Unsigned16	1 ... 1774	1	
Log. value for blanking area 3	11	BitArea(4 ... 7) 0 ... 4	0 ... 4	0	0: No beams blanked 1: Blanked beams = log. 0 2: Blanked beams = log. 1 3: Value = lower-value neighbor 4: Value = higher-value neighbor
Start beam of blanking area 3	12	Unsigned16	1 ... 1774	1	
End beam of blanking area 3	14	Unsigned16	1 ... 1774	1	
Log. value for blanking area 4	16	BitArea(0 ... 3) 0 ... 4	0 ... 4	0	0: No beams blanked 1: Blanked beams = log. 0 2: Blanked beams = log. 1 3: Value = lower-value neighbor 4: Value = higher-value neighbor
Start beam of blanking area 4	17	Unsigned16	1 ... 1774	1	
End beam of blanking area 4	19	Unsigned16	1 ... 1774	1	

Autosplitting configuration (module 17)



Configuration of autosplitting (areas).

Parameter	Rel. Adr.	Data type	Value range	Default	Description
Logical behavior of the area	0	Bit(7)0 ... 1	0 ... 1	0	0: Logical OR linked 1: Logical AND linked
Number of areas	0	BitArea(0 ... 6)	1 ... 111	1	Number of areas for autosplitting

Area settings (module 18)



To set multiple areas, you must configure the same module multiple times.

Configuration of the respective area: definition of the status conditions so that the area takes on a logical 1 or 0. For diagonal- or crossed-beam scanning, the numbers of the logical beams are to be entered.

Parameter	Rel. Adr.	Data type	Value range	Default	Description
Area configuration	0	BitArea(0 ... 5) 1 ... 32	1 ... 32	1	1: Area 01 ... 32: Area 32
Area (active/not active)	0	Bit (7) 0 ... 1	0 ... 1	0	0: Not active 1: Active
Logical behavior of the area	0	Bit(6) 0 ... 1	0 ... 1	0	0: Active HIGH 1: Active LOW
Start beam of the area	1	Unsigned16	1 ... 1774 65534 65533 65532 65531	1	65534: First interrupted beam (FIB) 65533: First uninterrupted beam (FNIB) 65532: Last interrupted beam (LIB) 65531: Last uninterrupted beam (LNIB)
End beam of the area	3	Unsigned16	1 ... 1774 65534 65533 65532 65531	1	65534: First interrupted beam (FIB) 65533: First uninterrupted beam (FNIB) 65532: Last interrupted beam (LIB) 65531: Last uninterrupted beam (LNIB)
Number of active beams → ON	5	Unsigned16	0 ... 1774	0	
Number of active beams → OFF	7	Unsigned16	0 ... 1774	0	
Specified middle of the area	9	Unsigned16	0 ... 1774	0	
Specified width of the area	11	Unsigned16	0 ... 1774	0	

13 Starting up the device - RS 485 Modbus interface

The configuration of an RS 485 Modbus interface involves the following steps on the receiver control panel and the RS 485 Modbus interface module of the control-specific configuration software.

General prerequisites:

- The measuring light curtain has been mounted (see chapter 6) and connected (see chapter 7) correctly.
- The basic configuration has been performed (see chapter 8).

13.1 Defining the RS 485 Modbus basic configuration on the receiver control panel

NOTICE

16-bit and 32-bit values in "little endian" format!

↪ Contrary to the Modbus specification, 16-bit and 32-bit values are handled in "little endian" format (low byte first). Example:

Value 25 as 16-bit value: 0x19 0x00

Value 25 as 32-bit value: 0x19 0x00 0x00 0x00

The parameters for the RS 485 Modbus interface are configured with the slave address, bit rate, parity and silent interval configurations.

The structure of these configurations in the receiver control panel menu is as follows:

Level 0	Level 1	Level 2	Description
Main Settings	Command		
	Operational setting		
	IO-Link		
	Modbus	Slave address	(enter value) min = 1 max = 247
		Bit rate	921.6 kbit/s 115.2kbit/s 57.6kbit/s 38.4 kbit/s 19.2 kbit/s 9.6 kbit/s 4.8 kbit/s
	Parity	none Straight Not straight	
	Silent Interval	0 =auto (enter value) min = 1 max = 30000 in 100 µs increments	

↪ Select **Main Settings > Modbus > Slave Address > Enter value.**

↪ Select **Main Settings > Modbus > Bit rate > Enter value.**

↪ Select **Main Settings > Modbus > Parity > Enter value.**

↪ Select **Main Settings > Modbus > Silent Interval > Enter value.**

The bit rate, the parity, the silent interval and the slave address are configured.

Other possible configuration steps are performed via the *Sensor Studio* configuration software (see chapter 15)

Process mode is configured via the RS 485 Modbus interface module of the control-specific software.

13.2 Defining configurations via the RS 485 Modbus interface module of the PLC software

In addition to the basic configurations (see chapter 8), the functionality of the CML 700i is configured according to the measurement application via the PLC with RS 485 Modbus telegrams.



During operation of the CML 700i on the RS 485 Modbus, all configuration parameters are set with adjustment values ex works (see default adjustment values in the following module descriptions). As long as these configuration parameters are not changed, the CML 700i operates with these default parameter values.

RS 485 Modbus protocol

The CML 700i with RS 485 Modbus interface communicates with Modbus protocol RTU (Remote Terminal Unit).

For the RS 485 Modbus protocol configurations, the following applies: 1 module = 2 bytes.

General structure of a serial RS 485 Modbus protocol telegram:

Address field	Function code	User data	Error check
---------------	---------------	-----------	-------------

Depending on the type of the RS 485 Modbus telegram (read access/write access or request/answer), all components can be contained in this general telegram structure or just some of them.

Access via RS 485 Modbus telegrams:

- Read access (see chapter 13.2.1)
The master (PLC) sends the slave (CML 700i) a 16-bit read access request that prompts the slave to send user data (e.g., measurement data and parameter values) as response telegram to the master.
- Write access (see chapter 13.2.2)
The master (PLC) sends a write-access command telegram (e.g., teach or reset) or write-access configuration telegram (e.g., for cascading) for controlling the slave (CML 700i). The response from the slave reflects the write access bit on the master, but without specifying the amount of user data and the user data.
- Error check (CRC calculation) (see chapter 13.2.3)
The CRC calculation is a frame test and is performed over all bytes of the telegram to be transmitted, including the slave address. The CRC bytes are appended to the end of the telegram.

13.2.1 Modbus read access

16-bit read access

Telegram frame:

01	03	00 10	00 10	72 03
(byte 1)	(byte 2)	(byte 3 ... 4)	(byte 5 ... 6)	(byte 7 ... 8)

Description of the bytes:

- Byte 1: 8-bit address, corresponds to the slave address set in the receiver control panel
- Byte 2: read access command = 0x03
- Byte 3: module ID = 0x00
- Byte 4: index (here, e.g., 0x10 returns the manufacturer name, see chapter 13.3)
- Bytes 5 ... 6: maximum accepted number/length of the response data in words (16 bit)
- Bytes 7 ... 8: 16-bit error check (Cyclic Redundancy Check, CRC) (see chapter 13.2.3)

Response to 16-bit read access (example)

Telegram frame:

01	03	20	4C 65 75 7A 65 20 65 6C 65 63 74 72 6F 6E 69 63 20 47 6D 62 48 20 2B 20 43 6F 2E 20 4B 47 00 00	40 E6
(byte 1)	(byte 2)	(byte 3)	(byte 4 ... 35)	(byte 36 ... 37)

Description of the bytes

- Byte 1: slave address
- Byte 2: read access command = 0x03 (repeat of the read command)
- Byte 3: amount of user data (20 – the actual number/length of the sent response data of the read access)
- Bytes 4 ... 35: user data (here, e.g., string with manufacturer designation)
- Bytes 36 ... 37: 16-bit error check (Cyclic Redundancy Check, CRC) (see chapter 13.2.3)

13.2.2 Modbus write access

16-bit write access

Telegram frame:

01	10	00 00	00 02	04	01 01 02 00	3F 36
(byte 1)	(byte 2)	(byte 3 ... 4)	(byte 5 ... 6)	(byte 7)	(byte 8 ... 11)	(byte 12 ... 13)

Description of the bytes:

- Byte 1: slave address
- Byte 2: write access command = 0x10
- Byte 3: module ID = 0x00
- Byte 4: index (here, e.g., 0x10 returns the manufacturer name, see chapter 13.3)
- Bytes 5 ... 6: maximum length of the response data in words (16 bit)
- Byte 7: number of bytes of transferred user data (= 2 x value in bytes 5 ... 6)
- Bytes 8 ... 11: user data
- Bytes 12 ... 13: 16-bit error check (Cyclic Redundancy Check, CRC) (see chapter 13.2.3)

Response to 16-bit write access

Telegram frame:

01	10	00 00	00 02	3F 36
(byte 1)	(byte 2)	(byte 3 ... 4)	(byte 5 ... 6)	(byte 7 ... 8)

Description of the bytes:

- Byte 1: slave address
- Byte 2: write access command = 0x10
- Byte 3: module ID = 0x00
- Byte 4: index (here, e.g., 0x10 returns the manufacturer name, see chapter 13.3)
- Bytes 5 ... 6: maximum length of the response data in words (16 bit)
- Bytes 7 ... 8: 16-bit error check (Cyclic Redundancy Check, CRC) (see chapter 13.2.3)

13.2.3 Error check (CRC calculation)



Example from the reference specification:

“MODBUS over serial line specification and implementation guide V1.0”, chapter 6.2.2

Example

An example of a C language function performing CRC generation is shown in the following. All of the possible CRC values are preloaded into two arrays, which are simply indexed as the function increments through the message buffer. One array contains all of the 256 possible CRC values for the high byte of the 16-bit CRC field, and the other array contains all of the values for the low byte.

Indexing the CRC in this way provides faster execution than would be achieved by calculating a new CRC value with each new character from the message buffer.



This function performs the swapping of the high/low CRC bytes internally. The bytes are already swapped in the CRC value that is returned from the function.

Therefore the CRC value returned from the function can be directly placed into the message for transmission.

The function takes two arguments:

Argument	Description
unsigned char *puchMsg;	A pointer to the message buffer containing binary data to be used for generating the CRC
unsigned short usDataLen;	The quantity of bytes in the message buffer.

CRC generation function:

```

unsigned short CRC16 (puchMsg, usDataLen);           /* The function returns the CRC as a unsigned short type */
unsigned char *puchMsg;                             /* message to calculate CRC upon */
unsigned short usDataLen;                           /* quantity of bytes in message */
{
    unsigned char uchCRCHi = 0xFF;                  /* high byte of CRC initialized */
    unsigned char uchCRCLo = 0xFF;                  /* low byte of CRC initialized */
    unsigned ulIndex;                               /* will index into CRC lookup table */

    while (usDataLen--)                             /* pass through message buffer */
    {
        ulIndex = uchCRCLo ^ *puchMsg++;           /* calculate the CRC */
        uchCRCLo = uchCRCHi ^ auchCRCHi[ulIndex];
        uchCRCHi = auchCRCLo[ulIndex];
    }
    return (uchCRCHi << 8 | uchCRCLo);
}
    
```

High-order byte table:

```

/* Table of CRC values for high-order byte */
static unsigned char auchCRCHi[] = {
0x00, 0xC1, 0x81, 0x40, 0x01, 0xC0, 0x80, 0x41, 0x01, 0xC0, 0x80, 0x41, 0x00, 0xC1, 0x81,
0x40, 0x01, 0xC0, 0x80, 0x41, 0x00, 0xC1, 0x81, 0x40, 0x00, 0xC1, 0x81, 0x40, 0x01, 0xC0,
0x80, 0x41, 0x01, 0xC0, 0x80, 0x41, 0x00, 0xC1, 0x81, 0x40, 0x00, 0xC1, 0x81, 0x40, 0x01,
0xC0, 0x80, 0x41, 0x00, 0xC1, 0x81, 0x40, 0x01, 0xC0, 0x80, 0x41, 0x01, 0xC0, 0x80, 0x41,
0x00, 0xC1, 0x81, 0x40, 0x01, 0xC0, 0x80, 0x41, 0x00, 0xC1, 0x81, 0x40, 0x00, 0xC1, 0x81,
0x40, 0x01, 0xC0, 0x80, 0x41, 0x00, 0xC1, 0x81, 0x40, 0x01, 0xC0, 0x80, 0x41, 0x01, 0xC0,
0x80, 0x41, 0x00, 0xC1, 0x81, 0x40, 0x00, 0xC1, 0x81, 0x40, 0x01, 0xC0, 0x80, 0x41, 0x01,
0xC0, 0x80, 0x41, 0x01, 0xC0, 0x80, 0x41, 0x00, 0xC1, 0x81, 0x40, 0x01, 0xC0, 0x80, 0x41,
0x00, 0xC1, 0x81, 0x40, 0x00, 0xC1, 0x81, 0x40, 0x01, 0xC0, 0x80, 0x41, 0x00, 0xC1, 0x81,
    
```

```

0x40, 0x01, 0xC0, 0x80, 0x41, 0x01, 0xC0, 0x80, 0x41, 0x00, 0xC1, 0x81, 0x40, 0x01, 0xC0,
0x80, 0x41, 0x00, 0xC1, 0x81, 0x40, 0x00, 0xC1, 0x81, 0x40, 0x01, 0xC0, 0x80, 0x41, 0x01,
0xC0, 0x80, 0x41, 0x00, 0xC1, 0x81, 0x40, 0x00, 0xC1, 0x81, 0x40, 0x01, 0xC0, 0x80, 0x41,
0x00, 0xC1, 0x81, 0x40, 0x01, 0xC0, 0x80, 0x41, 0x01, 0xC0, 0x80, 0x41, 0x00, 0xC1, 0x81,
0x40
};

```

13.2.4 Defining configurations via the PLC-specific software

General prerequisites:

- The measuring light curtain has been mounted (see chapter 6) and connected (see chapter 7) correctly.
- The basic configuration has been performed (see chapter 8).
- RS 485 Modbus-specific basic configurations have been performed.
 - Slave address selected
 - Bit rate selected
 - Parity selected
 - Silent interval entered



To configure the CML 700i, the user must set the parameters via RS 485 Modbus telegrams with read/write commands (see chapter 13.2.1/see chapter 13.2.2).



Information on using the configuration parameters can be found in the general descriptions of the individual functions of the CML 700i (see chapter 4).

- ↪ Open the configuration software of the RS 485 Modbus interface module.
- ↪ Configure the following configuration parameters:
 - Operating mode (parallel-beam; diagonal-beam; crossed-beam scanning)
 - Blanking settings
 - Teach settings
- ↪ Perform a teach. This is possible via the receiver control panel or the control group in the RS 485 Modbus process data.
- ↪ If necessary, configure additional parameter/process data (see chapter 13.3).
- ↪ Save the configuration via the control group in the RS 485 Modbus process data.

Saving ensures that the configuration is stored in non-volatile memory. Configurations that are not stored in non-volatile memory have only temporary effect and are lost when the device is switched off.

The RS 485 Modbus-specific configurations have been performed, copied to the CML 700i and the CML 700i is ready for process mode.

13.3 Parameter/process data for RS 485 Modbus

The configuration parameters or process data for RS 485 Modbus are defined via the following module descriptions.



The following **abbreviations for data types** apply in the following module descriptions:

t08U = type: 8 bit, unsigned CHAR

t08S = type: 8 bit, signed CHAR

t16U = type: 16 bit, unsigned SHORT

t16S = type: 16 bit, signed SHORT

Overview

Group	Group name
Group 1	System commands (see page 125)
Group 2	CML 700i status information (see page 126)
Group 3	Device description (see page 126)
Group 4	General configurations (see page 127)
Group 5	Extended settings (see page 127)
Group 6	Process data settings (see page 128)
Group 7	Cascading/trigger settings (see page 128)
Group 8	Blanking settings (see page 129)
Group 9	Teach settings (see page 130)
Group 10	Digital IO pin N settings (N = 2..5) (see page 130)
Group 11	Time module settings for digital outputs (see page 132)
Group 12	Configuration for block evaluation of beam areas (see page 132)
Group 13	Evaluation functions (see page 134)

System commands (group 1)



The system commands trigger a direct action in the CML 700i.

Parameter	Index (hex.)	Answer	Data type	Access	Value range	Default	Description
Command	84	4 bytes	t16U	RW	1 ... 8		1: Reserved 2: Reserved 3: Teach 4: Reboot 5: Reset 6: Save settings Notice: Processing of the Save command takes up to 600 ms. During this time, no other data/telegrams are accepted.

CML 700i status information (group 2)



The CML 700i status information specifies operating state information or error messages.

Parameter	Index (hex.)	Answer	Data type	Access	Value range	Default	Description
CML 700i status information	A2	2 bytes with the status information (counter), valid bit	t16U	RO			Operating state information or error messages
Teach information	45	2 bytes with teach information	t16U	RO	0, 1, 128	0	Status information on teach event 0: Teach successful 1: Teach running 128: Teaching error
Alignment status	46	4 bytes with alignment status		RO			Information on the signal level of the first and last beam. The value changes depending on the selected function reserve.
Signal level of last beam	46		t16U	RO		0	
Signal level of first beam	46		t16U	RO		0	

Device description (group 3)



The device description specifies the device characteristics, e.g., beam spacing, number of physical/logical individual beams, the number of cascades (16 individual beams) in the device and the cycle time.

Parameter	Index (hex.)	Answer	Data type	Access	Value range	Default	Description
Manufacturer name (Manufacturer name)	10	32 bytes with the manufacturer string	string 32 bytes	RO			Leuze electronic GmbH + Co. KG
Manufacturer text	11	64 bytes with the manufacturer text string	string 64 bytes	RO			Leuze electronic - the sensor people
Receiver product designation	12	64-byte string with the product designation	string 64 bytes	RO			Receiver type designation
Product description	13; 14	64-byte string with the product description	string 64 bytes	RO			E.g. "Measuring light curtain CML 730i" Series: CML 730i
Receiver serial number	15	16-byte string with the serial number	string 16 bytes	RO			Serial number of the receiver for unique product identification
Hardware version	16	20-byte string with hardware version	string 20 bytes	RO			
Firmware version	17	20-byte string with firmware version	string 20 bytes	RO			
Application-specific name	18	32-byte string with the application-specific name	string 32 bytes	RW			Device designation defined by the user
Receiver part no.	40	20-byte string with the part number	string 20 bytes	RO			Order number of the receiver (8-digit)

Parameter	Index (hex.)	Answer	Data type	Access	Value range	Default	Description
Transmitter product designation	41	64-byte string with the product designation of the transmitter	string 64 bytes	RO			Type designation
Transmitter part number	42	20-byte string with the part number of the transmitter	string 20 bytes	RO			Order number of the transmitter (8-digit)
Transmitter serial number	43	16-byte string with the transmitter serial number	string 16 bytes	RO			Transmitter serial number for unique product identification
Device description	44	10-byte string with the device description	string 10 bytes	RO			The device characteristics specify the beam spacing, the number of physical/logical individual beams, the number of cascades (16 individual beams) in the device and the cycle time.

General configurations (group 4)



Configured under group 4 “General configurations” are the type of scanning (parallel-/diagonal-/crossed-beam), counting direction and the minimum object diameter for the evaluation (smoothing). The minimum hole size for the evaluation, e.g., with web material, is configured via inverted smoothing.

Parameter	Index (hex.)	Answer	Data type	Access	Value range	Default	Description
General settings	47	4 bytes with the general settings		RW			
Beam mode	47		t08U	RW	0 ... 3	0	Beam mode 0: Parallel-beam scanning 1: Diagonal-beam scanning 2: Crossed-beam scanning 3: Beam matrix
Counting direction	47		t08U	RW	0 ... 1	0	Counting direction 0: Normal – starting with the connection piece 1: Inverted – ending with the connection piece
Smoothing	47		t08U	RW	1 ... 255	1	Smoothing: Less than i interrupted beams are ignored.
InvertedSmoothing	47		t08U	RW	1 ... 255	1	Inverted smoothing: Less than i free beams are ignored.

Extended settings (group 5)



The extended settings specify the autoteach function, filter depth (with respect to the number of interrupted beams as switching trigger) and integration time (hold function).

Parameter	Index (hex.)	Answer	Data type	Access	Value range	Default	Description
Extended settings	4A	4 bytes with the extended settings		RW			
Autoteach	4A		t08U	RW	0 ... 1	0	0: Not active 1: Active
Filter Depth	4A		t08U	RW	0 ... 255	1	The filter depth indicates the necessary number of consistent beam states before the evaluation of the measurement values. The filter depth corresponds to the number of passes with interrupted beam so that the result leads to switching.
Integration time	4A		t16U	RW	0 ... 65535	0	All measurement values are accumulated and retained over the duration of the integration time. Hold function in ms

Process data settings (group 6)



The process data settings describe the cyclically transmitted process data.

Procedure:

1. Write index 0x48
2. Write index 0xC0

After the last desired process data mapping, index 0xC0 is to be filled with the value 0. The position of the last process data mapping determines the length of the AutoSend telegram.

Parameter	Index (hex.)	Answer	Data type	Access	Value range	Default	Description
Process data settings	48	16 bytes with the process configuration data	t08U	RW	0; 0 ... 111; 200 ... 212	0	Process configuration data: 1 ... 111: Number of optical cascades for beam-stream evaluation (16 beams) 0: No evaluation (NOP) 200: First interrupted beam (FIB) 201: First uninterrupted beam (FNIB) 202: Last interrupted beam (LIB) 203: Last uninterrupted beam (LNIB) 204: Number of interrupted beams (TIB) 205: Number of uninterrupted beams (TNIB) 208: Switching state of areas 16 ... 1 209: Switching state of areas 32 ... 17 210: Switching state of the outputs mapped to the areas 212: CML 700i status information
Extended process data settings	C0	96 bytes with the process configuration data	t08U	RW	0; 0 ... 111; 200 ... 212	0	Extended process configuration data: 1 ... 111: Number of optical cascades for beam-stream evaluation (16 beams) 0: No evaluation (NOP) 200: First interrupted beam (FIB) 201: First uninterrupted beam (FNIB) 202: Last interrupted beam (LIB) 203: Last uninterrupted beam (LNIB) 204: Number of interrupted beams (TIB) 205: Number of uninterrupted beams (TNIB) 208: Switching state of areas 16 ... 1 209: Switching state of areas 32 ... 17 210: Switching state of the outputs mapped to the areas 212: CML 700i status information



For reasons of backwards compatibility with earlier device versions, the "Save" command saves extended process data settings in volatile memory. If more than 16 evaluation functions are required, this parameter must be written by the control unit each time the device is restarted.

Cascading/trigger settings (group 7)



To prevent mutual interference, multiple light curtains can be operated with a time offset with respect to one another (cascade). Here, the master generates the cyclical trigger signal; the slaves start their measurement after delay times, which are to be set to different values.

Parameter	Index (hex.)	Answer	Data type	Access	Value range	Default	Description
Cascading/trigger configuration	49	8 bytes with the trigger settings (cascading information)		RW			
Cascading	49		t08U	RW	0 ... 1	0	0: Not active (constant measurement of the sensor) 1: Active (sensor expects trigger signal)
Function type	49		t08U	RW	0 ... 1	0	0: Slave (expects trigger signal) 1: Master (sends trigger signal)

Parameter	Index (hex.)	Answer	Data type	Access	Value range	Default	Description
Trigger delay time → Start measurement	49		t16U	RW	500 ... 65 535	500	Slave: delay of rising edge of the trigger signal until start of the scan pass Unit: µs
Trigger width	49		t16U	RW	100	100	
Master cycle time	49		t16U	RW	1 ... 6500	1	Master: duration of a trigger cycle Unit: ms

Blanking settings (group 8)



Up to four beam areas can be deactivated. Deactivated beams can be assigned the logical values 0, 1 or the value of the adjacent beam. With auto blanking activated, up to four beam areas are automatically suppressed during teaching.

Auto blanking should only be activated during commissioning of the CML 700i to suppress interfering objects. In process mode, auto blanking should be deactivated.

For details on this topic see chapter 14.4.

NOTICE
Perform teach after changing the blanking configuration!
↪ Perform a teach after changing the blanking configuration.
A teach can be performed via the receiver control panel or via the teach command.

Parameter	Index (hex.)	Answer	Data type	Access	Value range	Default	Description
Blanking area configuration	4C	26 bytes with blanking settings		RW			
Number of auto-blanking areas	4C		t08U	RW	0 ... 4	0	Permissible number of auto-blanking areas 0: 0 auto-blanking areas 1: 1 auto-blanking area 2: 2 auto-blanking areas 3: 3 auto-blanking areas 4: 4 auto-blanking areas
Auto blanking (during teaching)	4C		t08U	RW	0 ... 1	0	0: Not active (manual blanking area configuration) 1: Active (automatic area configuration through teach)
Logical value for blanking area 1	4C		t16U	RW	0 ... 4	0	0: No beams blanked 1: Logical value 0 for blanked beams 2: Logical value 1 for blanked beams 3: Logical value = same as adjacent beam with lower beam number 4: Logical value = same as adjacent beam with higher beam number
Start beam of blanking area 1	4C		t16U	RW	1 ... 1774	0	
End beam of blanking area 1	4C		t16U	RW	1 ... 1774	0	
.....
.....

Parameter	Index (hex.)	Answer	Data type	Access	Value range	Default	Description
Logical value for blanking area 4	4C		t16U	RW	0 ... 4	0	0: No beams blanked 1: Logical value 0 for blanked beams 2: Logical value 1 for blanked beams 3: Logical value = same as adjacent beam with lower beam number 4: Logical value = same as adjacent beam with higher beam number
Start beam of blanking area 4	4C		t16U	RW	1 ... 1774	0	
End beam of blanking area 4	4C		t16U	RW	1 ... 1774	0	

Teach settings (group 9)



In most applications, it is recommended that the teach values be stored in non-volatile memory.

Depending on the function reserve selected for the teach event, the sensitivity is higher or lower (high function reserve = low sensitivity; low function reserve = high sensitivity).

Parameter	Index (hex.)	Answer	Data type	Access	Value range	Default	Description
Teach configuration	4F	4 bytes teach configuration		RW			
Number of measurement cycles for minimum value creation during teaching	4F		t08U	RW		128	
Type of storage for teach values	4F		t08U	RW	0 ... 1	0	0: Save the parameters in flash (non-volatile storage of teach values) 1: In RAM (volatile, i.e., teach values only saved while voltage ON)
Sensitivity adjustment for teach event	4F		t08U	RW	0 ... 3	0	Sensitivity of the measurement system 0: High function reserve (for stable operation) 1: Medium function reserve 2: Low function reserve 3: Transparent media
Switching threshold	4F		t08U	RW	10 ... 98	75	Threshold as percentage of teach threshold (50% = function reserve 2)

Digital IO pin N settings (N = 2, 5) (group 10)



In this group, the inputs/outputs can be set to positive switching (PNP) or to negative switching (NPN). The switching behavior applies the same for all inputs/outputs.

Moreover, the inputs/outputs can be configured via this group: pins 2, 5 for fieldbus and analog devices, such as RS 485 Modbus; pins 2, 5, 6, 7 for IO-Link devices (see chapter 10 "Starting up the device - IO-Link interface").

Parameter	Index (hex.)	Answer	Data type	Access	Value range	Default	Description
Switching level of the inputs/outputs	4D	4 bytes, switching level configuration of the inputs/outputs	t08U	RW	0 ... 1	1	Switching level of the inputs/outputs 0: Transistor, NPN 1: Transistor, PNP Notice on the data structure: 0x00000000, 0x00010000, 0x00020000 The last two bytes are filler bytes and are ignored
Keyboard lock	4E	2 bytes keyboard lock configuration	t08U	RW	0 ... 2		Notice on the data structure: ??0x00000000, 0x00010000, 0x00020000 The last two bytes are filler bytes and are ignored. • ??ID: 0x00 • ??Parameter: 0x4E Read: 2 bytes • 0x00 0xFF • 0x01 0xFF • 0x02 0xFF Examples • ReadRequest send string (read access) 01 03 00 4E 00 01 E4 1D • ReadRequest response string (response to read access) 01 03 02 00 FF F8 04 ??Write: 0x00NN, 0x01NN, 0x02NN • 0x00NN: No lock set • 0x01NN: Permanent lock • 0x02NN: Temporary lock • NN: 0xFF; 0x00 allowed Examples • WriteRequest send string (write access): 01 10 00 4E 00 01 02 00 FF E9 FE • WriteRequest response string (response to write access): 01 10 00 4E 00 01 61 DE
Configuration of pin 2							
Digital IO Pin 2 Settings	50	4 bytes, configuration IO1		RW			
Input/output selection	50		t08U	RW	0 ... 1	0	0: Output 1: Input
Switching behavior	50		t08U	RW	0 ... 1	0	0: Not active (normal - light switching) 1: Active (inverted - dark switching)
Input function	50		t08U	RW	0 ... 2	0	0: Not active 1: Trigger input (Trigger In) 2: Teach input (Teach In)
Output function	50		t08U	RW	0 ... 3	0	0: Not active 1: Switching output (area 1 ... 32) 2: Warning output 3: Trigger output
Configuration of pin 5							
Digital IO Pin 5 Settings	51	4 bytes, configuration IO2		RW			
Input/output selection	51		t08U	RW	0 ... 1	0	0: Output 1: Input
Switching behavior	51		t08U	RW	0 ... 1	0	0: Not active (normal - light switching) 1: Active (inverted - dark switching)
Input function	51		t08U	RW	0 ... 2	0	0: Not active 1: Trigger input (Trigger In) 2: Teach input (Teach In)
Output function	51		t08U	RW	0 ... 3	0	0: Not active 1: Switching output (area 1 ... 32) 2: Warning output 3: Trigger output

Settings for digital switching outputs (group 11)



Four different time functions can be configured in this group.

Map the output to areas 1 ... 32. Activate the area by entering a 1 at the corresponding position in the 32-bit word. Area 1 ... 32 increasing from right.

Parameter	Index (hex.)	Answer	Data type	Access	Value range	Default	Description
Configuration of switching output pin 2	54	4 bytes, configuration output 1		RW			Four different time functions can be set. Max. time duration that can be set is 65 s. Map the output to switching areas 1 ... 32.
Operating mode of the time module	54		t08U	RW	0 ... 4	0	0: Not active 1: Start-up delay 2: Switch-off delay 3: Pulse stretching 4: Pulse suppression
Time constant for selected function	54		t16U	RW	0 ... 65535	0	Unit: ms
Area mapping	54		t32U	RW	0 ... 4294967295	1: For DO1 2: For DO2 4: For DO3 8: For DO4	Logical OR link mask of the switching outputs
Digital switching output pin 5	55	4 bytes, configuration output 2		RW			Four different time functions can be set. Max. time duration that can be set is 65 s. Map the output to switching areas 1 ... 32.
Operating mode of the time module	55		t08U	RW	0 ... 4	0	0: Not active 1: Start-up delay 2: Switch-off delay 3: Pulse stretching 4: Pulse suppression
Time constant for selected function	55		t16U	RW	0 ... 65535	0	Unit: ms
Area mapping	55		t32U	RW	0 ... 4294967295	1: For DO1 2: For DO2 4: For DO3 8: For DO4	Logical OR link mask of the switching outputs

Configuration for block evaluation of beam areas (group 12)



In this group, a detailed area configuration can be displayed and a beam area configured for the block evaluation.

Parameter	Index (hex.)	Answer	Data type	Access	Value range	Default	Description
Configuration of area 01	64	14 bytes info area 01		RW			Configuration of area 01: definition of the status conditions so that the area takes on a logical 1 or 0. For diagonal- or crossed-beam mode, the numbers of the logical beams are to be entered.
Area	64		t08U	RW	0 ... 1	0	0: Not active 1: Active
Active beam	64		t08U	RW	0 ... 1	0	0: Light switching (beam is active if light path is free) 1: Dark switching (beam is active if light path is interrupted)

Parameter	Index (hex.)	Answer	Data type	Access	Value range	Default	Description
Start beam of the area	64		t16U	RW	1 ... 1774 65534 65533 65532 65531	1	Dynamic start positions are created by means of entries in the form of impossible beam numbers. 65534: First interrupted beam (FIB) 65533: First uninterrupted beam (FNIB) 65532: Last interrupted beam (LIB) 65531: Last uninterrupted beam (LNIB)
End beam of the area	64		t16U	RW	1 ... FFE E	1	
Number of active beams for area ON	64		t16U	RW	0 ... 1774	0	
Number of active beams for area OFF	64		t16U	RW	0 ... 1774	0	
Specified middle of the area	64		t16U	RW	0 ... 1774	0	
Specified width of the area	64		t16U	RW	0 ... 1774	0	
Configuration of area 02	65	14 bytes info area 02		RW			Configuration of area 02: definition of the status conditions so that the area takes on a logical 1 or 0. For diagonal- or crossed-beam mode, the numbers of the logical beams are to be entered.
Area	65		t08U	RW	0 ... 1	0	0: Not active 1: Active
Active beam	65		t08U	RW	0 ... 1	0	0: Light switching (beam is active if light path is free) 1: Dark switching (beam is active if light path is interrupted)
Start beam of the area	65		t16U	RW	1 ... 1774 65534 65533 65532 65531	1	Dynamic start positions are created by means of entries in the form of impossible beam numbers. 65534: First interrupted beam (FIB) 65533: First uninterrupted beam (FNIB) 65532: Last interrupted beam (LIB) 65531: Last uninterrupted beam (LNIB)
End beam of the area	65		t16U	RW	1 ... 1774 65534 65533 65532 65531	1	Dynamic start positions are created by means of entries in the form of impossible beam numbers. 65534: First interrupted beam (FIB) 65533: First uninterrupted beam (FNIB) 65532: Last interrupted beam (LIB) 65531: Last uninterrupted beam (LNIB)
Number of active beams for area ON	65		t16U	RW	0 ... 1774	0	
Number of active beams for area OFF	65		t16U	RW	0 ... 1774	0	
Specified middle of the area	65		t16U	RW	0 ... 1774	0	
Specified width of the area	65		t16U	RW	0 ... 1774	0	
....
....
Configuration of area 32	83	14 bytes info area 32		RW			Configuration of area 32: definition of the status conditions so that the area takes on a logical 1 or 0. For diagonal- or crossed-beam mode, the numbers of the logical beams are to be entered.
Area	83		t08U	RW	0 ... 1	0	0: Not active 1: Active
Active beam	83		t08U	RW	0 ... 1	0	0: Light switching (beam is active if light path is free) 1: Dark switching (beam is active if light path is interrupted)

Parameter	Index (hex.)	Answer	Data type	Access	Value range	Default	Description
Start beam of the area	83		t16U	RW	1 ... 1774 65534 65533 65532 65531	1	Dynamic start positions are created by means of entries in the form of impossible beam numbers. 65534: First interrupted beam (FIB) 65533: First uninterrupted beam (FNIB) 65532: Last interrupted beam (LIB) 65531: Last uninterrupted beam (LNIB)
End beam of the area	83		t16U	RW	1 ... 1774 65534 65533 65532 65531	1	Dynamic start positions are created by means of entries in the form of impossible beam numbers. 65534: First interrupted beam (FIB) 65533: First uninterrupted beam (FNIB) 65532: Last interrupted beam (LIB) 65531: Last uninterrupted beam (LNIB)
Number of active beams for area ON	83		t16U	RW	0 ... 1774	0	
Number of active beams for area OFF	83		t16U	RW	0 ... 1774	0	
Specified middle of the area	83		t16U	RW	0 ... 1774	0	
Specified width of the area	83		t16U	RW	0 ... 1774	0	

Evaluation functions (group 13)



In this group, all evaluation functions can be configured.

Parameter	Index (hex.)	Answer	Data type	Access	Value range	Default	Description
First interrupted beam (FIB)	96	2 bytes with the number of the first interrupted beam	t16U	RO			Logical beam number of the first darkened individual beam. The logical beam numbers change in diagonal- or crossed-beam mode. Note any changed configuration of the counting direction!
First uninterrupted beam (FNIB)	97	2 bytes with the number of the first uninterrupted beam	t16U	RO			Logical beam number of the first undarkened individual beam. The logical beam numbers change in diagonal- or crossed-beam mode. Note any changed configuration of the counting direction!
Last interrupted beam (LIB)	98	2 bytes with the number of the last interrupted beam	t16U	RO			Logical beam number of the last darkened individual beam. The logical beam numbers change in diagonal- or crossed-beam mode. Note any changed configuration of the counting direction!
Last uninterrupted beam (LNIB)	99	2 bytes with the number of the last uninterrupted beam	t16U	RO			Logical beam number of the last undarkened individual beam. The logical beam numbers change in diagonal- or crossed-beam mode. Note any changed configuration of the counting direction!
Number of interrupted beams (TIB)	9A	2 bytes with the number of interrupted beams	t16U	RO			Sum of all darkened individual beams. The sum changes for diagonal- or crossed-beam scanning.
Number of uninterrupted beams (TNIB)	9B	2 bytes with the number of uninterrupted beams	t16U	RO			Sum of all undarkened individual beams. The sum changes for diagonal- or crossed-beam scanning.
Status of areas 16 ... 1	9E	2 bytes	t16U	RO			Status of areas 01 ... 16 as 2 bytes of process data (Area Out LoWord)
Status of areas 32 ... 17	9F	2 bytes	t16U	RO			Status of areas 17 ... 32 as 2 bytes of process data (Area Out HiWord)
Status digital inputs/outputs	A0	2 bytes	t16U	RO			Result of the area evaluation to which pins are mapped (logical status of the area evaluation mapped to the pin)

Parameter	Index (hex.)	Answer	Data type	Access	Value range	Default	Description
Status of process data object	AA	32 bytes		RO			Representation of the 16 evaluation functions mapped with the <i>process data settings</i> configuration (see *** 'Process data settings (group 6)' on page 128 ***).
Beam-stream object	BD	222 bytes	array	RO			PD beam-stream Notice: This is the only object for which it is permitted to specify a length in the read telegram that is smaller than the object length itself. You can request between 1 ... 222 bytes.

13.4 Autosend mode

In normal mode, the master sends a query to the slave and the slave responds.

In autosend mode, the slave constantly sends datablocks to the master; the master activates this by sending a query to the slave once. In autosend mode, a freely definable datablock (process data – between 32 and 224 bytes) is transmitted by the CML 700i to the PLC as fast as possible with little “overhead”.



Restrictions/boundary conditions:

Autosend mode is not compatible with the Modbus definition.

Autosend communication is only possible between two participants, i.e., for point-to-point connection between master (PLC) and a slave (CML 700i).

The PLC must be able to process the data transmitted by the CML 700i.



The silent interval has no effect on autosend mode. The silent interval only influences the response time in RS 485 Modbus mode.

With a silent interval > 0, the response of the CML 700i to a master query is output with a delay and the RS 485 direction changeover performed (half duplex mode).

To throttle the data output of the CML 700i, select a lower bit rate or use the cascading functions (see chapter 4.9 "Cascading/triggering").

To send data in a meaningful way in autosend mode, proceed as follows:

- ↳ Configure the process data by means of the Modbus command.
- ↳ Use the PLC to switch the CML 700i to autosend mode via the Modbus command described in the following.

Data frame structure

Byte no.	Modbus action (from the perspective of the CML 700i)	Description
0	send	Number of user data bytes (i)
1	send	8-bit checksum of all user data bytes and the number of user data bytes (checksum is the 1-byte sum of all user data, i.e., carryovers on the 9th bit are lost)
2 ... i + 1	send	i user data byte(s)
	changeover	Changeover to receive; CML 700i waits for EOT byte (0x04) from the PLC (Modbus master)
	changeover	Changeover to send if no EOT byte was received
i + x ...	receive	Repeat with byte 0, etc., if autosend is not stopped

Changeover from RS 485 Modbus to autosend mode

Message from master (PLC) to slave (CML 700i): (AUTOSEND ON)

HEX: 01 05 00 00 FF 00 8C 3A

Expected answer from slave (CML 700i) to master (PLC): (AUTOSEND ON)

HEX: 01 05 00 00 FF 00 8C 3A

- 01 = Slave address 1
- 05 = Write-coil command
- 00 00 = Address 1 (application level; counting technically begins with zero)
- 00 00 = *OFF*
- FF 00 = *ON*
- 8C 3A = CRC checksum

Changeover from autosend mode to RS 485 Modbus

To switch back from autosend mode to RS 485 Modbus, the control (RS 485 Modbus master) must send an “End-Of-Transmission” (EOT) byte (0x04) to the CML 700i. In the autosend transmission frame, a time window is provided for receiving the EOT byte. The time window in which the control may send the EOT byte begins after approx. 1.5 characters (start time) after the CML 700i has received the last character. The character must be transmitted within the time window of approx. 3 characters. The times are multiples of 100 µs. For high bit rates, the start time is fixed at 100 µs and the entire EOT-byte time window is 200 µs long.

Bit rate (bit/s)	Pause for EOT byte (i * 100 µs)	Description
4.800	27	Time window for receiving the EOT byte
9.600	13	
19.200	6	
38.400	3	
57.600	2	
115.200	1	
921.600	1	

14 Example configurations

14.1 Example configuration - Reading out 64 beams (beam-stream)

The beam-stream evaluation function is used, e.g., for evaluating the size and position of objects on a transport system.

14.1.1 Configuration of beam-stream process data via IO-Link interface

↪ Map the beam states of the individual optical cascades in the CML 700i to the process data as follows.

Evaluation function 01 (group 6)	Index 72, bit offset 120 = 1	(The first optical cascade (beams 1 ... 16) is transmitted in process data module 01)
Evaluation function 02 (group 6)	Index 72, bit offset 112 = 2	(The second optical cascade (beams 17 ... 32) is transmitted in process data module 02)
Evaluation function 03 (group 6)	Index 72, bit offset 104 = 3	(The third optical cascade (beams 33 ... 48) is transmitted in process data module 03)
Evaluation function 04 (group 6)	Index 72, bit offset 96 = 4	(The fourth optical cascade (beams 49 ... 64) is transmitted in process data module 04)

14.1.2 Configuration of beam-stream process data via CANopen interface

↪ Map the TPDO1 as follows.

MAPPINGENTRY1	24120110	(Index 0x2412 sub-index 01 is mapped, length of the mapped object: 16 bit)
MAPPINGENTRY2	24120210	(Index 0x2412 sub-index 02 is mapped, Length of the mapped object: 16 bit)
MAPPINGENTRY3	24120310	(Index 0x2412 sub-index 03 is mapped, Length of the mapped object: 16 bit)
MAPPINGENTRY4	24120410	(Index 0x2412 sub-index 04 is mapped, Length of the mapped object: 16 bit)

These 32 bits are to be read as follows:

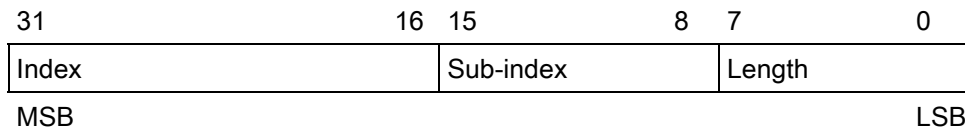

This means that 4 x 16 bit objects can be mapped per PDO → 64 beams.

14.1.3 Configuration of beam-stream process data via Profibus interface

↪ Map the beam states of the 64 beams starting with the first optical cascade in the CML 700i to the beam-stream (64 bits) as follows:

Beam-stream (64 bit) (module 4)	Parameter <i>number of the optical cascade</i> = 1	(The first optical cascade (beams 1 ... 64) is transmitted in the beam-stream module (64 bit))
--	--	--

Digital IO Pin 2 Settings (group 10)	Index 80, bit offset 24:	= 0	(pin 2 as output)
	Index 80, bit offset 16:	= 1	(switching behavior inverted)
	Index 80, bit offset 0:	= 1	(switching output area 32 ... 1)
	Index 84, bit offset 0:	= 1	(bit mapping of area 01 to pin 2)

14.2.3 Configuration of area/output mapping via CANopen interface

↪ Map the beams to output pin 2 as follows.

Configuration of area 01 (module 8)	Index 0x2170 sub 01:	= 1	(area 01 active)
	Index 0x2170 sub 02:	= 0	(light switching)
	Index 0x2170 sub 03:	= 1	(start beam of the area)
	Index 0x2170 sub 04:	= 32	(end beam of the area)
	Index 0x2170 sub 05:	= 32	(number of active beams for area ON)
	Index 0x2170 sub 06:	= 31	(number of active beams for area OFF)
Switching level of the inputs/outputs (module 7)	Index 0x2151 sub 01:	= 0	(pin 2 as output)
	Index 0x2151 sub 03:	= 1	(switching behavior inverted)
	Index 0x2151 sub 04:	= 1	(switching output area 32 ... 1)
	Index 0x2155 sub 03:	= 1	(bit mapping of area 01 to pin 2)

14.2.4 Configuration of area/output mapping via Profibus interface

↪ Map the beams to output pin 2 as follows.

Area settings (module 17)	Parameter <i>Area configuration.</i>	= 1	(area 01 selected)
	Parameter <i>Area.</i>	= 1	(area 01 active)
	Parameter <i>Logical behavior of the area.</i>	= 0	(active HIGH)
	Parameter <i>Start beam of the area.</i>	= 1	(start beam of the area)
	Parameter <i>End beam of the area.</i>	= 32	(end beam of the area)
	Parameter <i>Number of active beams → ON.</i>	= 32	(number of active beams for area ON)
	Parameter <i>Number of active beams → OFF.</i>	= 31	(number of active beams for area OFF)
Configuration of digital I/Os (module 12)	Parameter <i>Pin 2 - Input/output selection.</i>	= 0	(pin 2 as output)
	Parameter <i>Pin 2 - Switching behavior.</i>	= 1	(switching behavior inverted)
	Parameter <i>Pin 2 - Output function.</i>	= 1	(switching output area 1 ... 32)
	Parameter <i>Pin 2 - Area mapping 32 ... 1.</i>	= 1	(bit mapping of area 01 to pin 2)

14.2.5 Configuration of area/output mapping via RS 485 Modbus interface

↪ Map the beams to output pin 2 as follows.

Area 01 (group 12)	Parameter <i>0x64 area 01</i>	Write access (specified middle and specified width remain zero): 01 10 00 64 00 07 0E 01 00 01 00 20 00 20 00 1F 00 00 00 00 00 A6 5F Response to write access: 01 10 00 64 00 07 C0 14
Digital IO Pin 2 Settings (group 10)	Parameter <i>0x50 Digital IO Pin 2 Settings</i>	Write access: 01 10 00 50 00 02 04 01 00 00 00 F7 6F Response to write access: 01 10 00 50 00 02 41 D9
Configuration of switching output pin 2 (group 11)	Parameter <i>0x54 configuration of switching output pin 2 settings</i>	Write access: 01 10 00 54 00 04 08 00 00 00 00 01 86 8A Response to write access: 01 10 00 54 00 04 80 1A

14.3 Example configuration - Hole recognition

The following table shows an example configuration for hole recognition for web material with signaling of a hole at output pin 2. Example for detection beginning with a free beam with fixed/dynamic web position.

↳ First activate and configure a beam area (e.g., area 01).

Description / variables		
Configuration of area 01		
Area Value: 1 = active	01	This area is active and is then mapped to output pin 2.
Logical behavior of the area Value: 0 = normal - light switching	00	Switching in case of free beams.
Start beam of the area Value: FIB for dynamic web position or fixed position value, if specified	FIB	If a hole is to be detected in a web with arbitrary position or width, the value FIB is to be set for the start beam. With fixed position value, the start beam of the area is to be set.
End beam of the area Value: LIB for dynamic web position or fixed position value, if specified	LIB	If a hole is to be detected in a web with arbitrary position or width, the value LIB is to be set for the end beam. With fixed position value, the end beam of the area is to be set.
Number of active beams for area ON Value: 1	1	With this setting, the area (output) switches as soon as one or more beams are not interrupted.
Number of active beams for area OFF Value: 0	0	

↳ Map the area to the corresponding switching output.

Description / variables		
Configuration of pin 2		
Input/output selection	Value: 0 = output	Pin 2 functions as digital output
Function of the switching output	Value: 1 = switching output area 1 ... 32	The switching output signals the logical states of beam areas 1 ... 32
Switching behavior	Switching behavior Value: 0 = normal - light switching Value: 1 = inverted - dark switching	Configuration according to the necessary switching behavior of the output

↳ Map configured area 1 to pin 2.

Digital Output 2 Settings	
Area mapping 32 ... 1 (OR combination)	0b 0000 0000 0000 0000 0000 0000 0001

14.3.1 Configuration of hole recognition via IO-Link interface

↳ For hole recognition for web material map hole indication to output pin 2.

Configuration of area 01 (group 14)	Index 00, bit offset 104:	= 1	(area 01 active)
	Index 100, bit offset 96:	= 0	(light switching)
	Index 100, bit offset 80:	= 65534	(start beam of the area) dynamic: on 65534 (start beam = FIB)
	Index 100, bit offset 64:	= 65532	(end beam of the area) dynamic: on 65532 (start beam = LIB)
	Index 100, bit offset 48:	= 1	(number of active beams for area ON)
	Index 100, bit offset 32:	= 0	(number of active beams for area OFF)
Digital IO Pin 2 Settings (group 10)	Index 80, bit offset 24:	= 0	(pin 2 as output)
	Index 80, bit offset 16:	= 1	(switching behavior inverted)
	Index 80, bit offset 0:	= 1	(switching output area 32 ... 1)
	Index 84, bit offset 0:	= 1	(bit mapping of area 01 to pin 2)

14.3.2 Configuration of hole recognition via CANopen interface

↪ For hole recognition for web material map hole indication to output pin 2.

Configuration of area 01 (module 8)	Index 0x2170 sub 01:	= 1	(area 01 active)
	Index 0x2170 sub 02:	= 0	(light switching)
	Index 0x2170 sub 03:	= 65534	(start beam of the area) dynamic: on 65534 (start beam = FIB)
	Index 0x2170 sub 04:	= 65532	(end beam of the area) dynamic: on 65532 (start beam = LIB)
	Index 0x2170 sub 05:	= 1	(number of active beams for area ON)
	Index 0x2170 sub 06:	= 0	(number of active beams for area OFF)
Switching level of the inputs/outputs (module 7)	Index 0x2151 sub 01:	= 0	(pin 2 as output)
	Index 0x2151 sub 03:	= 1	(switching behavior inverted)
	Index 0x2151 sub 04:	= 1	(switching output area 32 ... 1)
	Index 0x2155 sub 03:	= 1	(bit mapping of area 01 to pin 2)

14.3.3 Configuration of hole recognition via Profibus interface

↪ For hole recognition for web material map hole indication to output pin 2.

Area settings (module 17)	Parameter <i>Area configuration:</i>	= 1	(area 01 selected)
	Parameter <i>Area:</i>	= 1	(area 01 active)
	Parameter <i>Logical behavior of the area:</i>	= 0	(active HIGH)
	Parameter <i>Start beam of the area:</i>	= 65534	(start beam of the area) dynamic: on 65534 (start beam = FIB)
	Parameter <i>End beam of the area:</i>	= 65532	(end beam of the area) dynamic: on 65532 (start beam = LIB)
	Parameter <i>Number of active beams → ON:</i>	= 1	(number of active beams for area ON)
	Parameter <i>Number of active beams → OFF:</i>	= 0	(number of active beams for area OFF)
Configuration of digital I/Os (module 12)	Parameter <i>Pin 2 - Input/output selection:</i>	= 0	(pin 2 as output)
	Parameter <i>Pin 2 - Switching behavior:</i>	= 1	(switching behavior inverted)
	Parameter <i>Pin 2 - Output function:</i>	= 1	(switching output area 1 ... 32)
	Parameter <i>Pin 2 - Area mapping 32 ... 1:</i>	= 1	(bit mapping of area 01 to pin 2)

14.3.4 Configuration of hole recognition via RS 485 Modbus interface

↪ For hole recognition for web material map hole indication to output pin 2.

Area 01 (group 12)	Parameter <i>0x64 area 01</i>	Write access (specified middle and specified width remain zero): 01 10 00 64 00 07 0E 01 00 FF FE FF FC 00 01 00 00 00 00 00 00 4E 48 Response to write access: 01 10 00 64 00 07 C0 14
Digital IO Pin 2 Settings (group 10)	Parameter <i>0x50 Digital IO Pin 2 Settings</i>	Write access: 01 10 00 50 00 02 04 00 00 01 F7 03 Response to write access: 01 10 00 50 00 02 41 D9
Configuration of switching output pin 2 (group 11)	Parameter <i>0x54 configuration of switching output pin 2</i>	Write access: 01 10 00 54 00 04 08 00 00 00 00 00 01 FF C6 A5 Response to write access: 01 10 00 54 00 04 80 1A

14.4 Example configuration - Activating and deactivating blanking areas

14.4.1 Configuration of blanking areas (general)

↳ Perform the following settings to activate or deactivate blanking areas.

Example: automatic blanking of two areas during teaching

Blanking settings	Parameter <i>Number of auto blanking areas:</i>	= 2	(two blanking areas permitted)
	Parameter <i>Auto blanking (during teaching):</i>	= 1	(automatic blanking-area configuration active)
System commands	Parameter <i>Teach command:</i>	= 1	(execute teach command)

Example: Deactivation/resetting of auto blanking

Blanking settings	Parameter <i>Number of auto blanking areas:</i>	= 0	(no blanking areas permitted)
	Parameter <i>Auto blanking (during teaching):</i>	= 0	(automatic blanking area configuration not active)
Blanking settings	Parameter <i>Function for blanking area/logical value for blanking area 1:</i>	= 0	(no beams blanked)
	Parameter <i>Function for blanking area/logical value for blanking area 2:</i>	= 0	(no beams blanked)
System commands	Parameter <i>Teach command:</i>	= 1	(execute teach command)

14.4.2 Configuration of blanking areas via IO-Link interface

↳ Perform blanking area activation and deactivation.

Example: automatic blanking of two areas during teaching

Blanking settings (group 8)	Index 76, bit offset 200:	= 2	(two blanking areas permitted)
	Index 76, bit offset 192:	= 1	(automatic blanking-area configuration active)
System commands (group 1)	Index 2	= 162	(perform teach)

In the background, the values of objects INDEX 76 sub-index 3 et seq. are calculated and stored in non-volatile memory. Upon successful teach completion, all other objects of index 76 are stored in non-volatile memory if index 79, sub-index 2 is set to value 0 = non-volatile storage of teach values.

Example: Deactivation/resetting of auto blanking

Blanking settings (group 8)	Index 76, bit offset 200:	= 0	(no blanking areas permitted)
	Index 76, bit offset 192:	= 0	(automatic blanking area configuration not active)

Blanking settings (group 8)	Index 76, bit offset 176:	= 0	(no beams blanked)
	Index 76, bit offset 176:	= 0	(no beams blanked)
System commands (group 1)	Index 2:	= 162	(perform teach)

14.4.3 Configuration of blanking areas via CANopen interface

↳ Perform blanking area activation and deactivation.

Example: automatic blanking of two areas during teaching

Blanking settings (module 6)	Index 0x2104 sub 01:	= 2	(two blanking areas permitted)
	Index 0x2104 sub 02:	= 1	(automatic blanking-area configuration active)
Commands (module 9)	Index 0x2200 sub 01:	= 3	(perform teach)

In the background, the values of objects 0x2104 sub 04 and 0x2104 sub 05 as well as 0x2104 sub 07 and 0x2104 sub 08 are calculated and stored in non-volatile memory. Following a successful teach, all other 0x2104 objects are stored in non-volatile memory if 0x2103 sub 02 is set to value 0 = non-volatile storage of teach values.

Example: Deactivation/resetting of auto blanking

Blanking settings (module 6)	Index 0x2104 sub 01:	= 0	(no blanking areas permitted)
	Index 0x2104 sub 02:	= 0	(automatic blanking area configuration not active)
Blanking settings (module 6)	Index 0x2104 sub 03:	= 0	(no beams blanked)
	Index 0x2104 sub 03:	= 0	(no beams blanked)
Commands (module 9)	Index 0x2200 sub 01:	= 3	(perform teach)

14.4.4 Configuration of blanking areas via Profibus interface

↳ Perform blanking area activation and deactivation.

Example: automatic blanking of two areas during teaching

Blanking configuration (module 5)	Parameter <i>Number of auto blanking areas</i>	= 2	(two blanking areas permitted)
	Parameter <i>Auto blanking (during teaching)</i>	= 1	(automatic blanking-area configuration active)
Sensor control module (module 0)	Change value of byte 2		(perform teach)

In the background, the configuration for blanking areas 01 and 02 is calculated and stored in non-volatile memory. Upon successful teach completion, all other objects of the blanking configuration are stored in non-volatile memory if the *Type of storage for teach values* parameter is set to value 0 = non-volatile storage of teach values.

Example: Deactivation/resetting of auto blanking

Blanking configuration (module 15)	Parameter <i>Number of auto blanking areas</i>	= 0	(no blanking areas permitted)
	Parameter <i>Auto blanking (during teaching)</i>	= 0	(automatic blanking area configuration not active)
Blanking configuration (module 15)	Parameter <i>Log. value for blanking area 1</i>	= 0	(no beams blanked)
	Parameter <i>Log. value for blanking area 2</i>	= 0	(no beams blanked)
Sensor control module (module 0)	Change value of byte 2		(perform teach)

14.4.5 Configuration of blanking areas via RS 485 Modbus interface

↪ Perform blanking area activation and deactivation.

Example: automatic blanking of two areas during teaching

Blanking area configuration (group 8)	Parameter <i>0x4C configuration of blanking areas</i>	Write access: 01 10 00 4C 00 0D 1A 02 01 00 00 01 00 01 00 00 00 01 00 01 00 00 00 01 00 01 00 00 00 01 00 01 00 B2 52 Response to write access: 01 10 00 4C 00 0D C0 1B
Rx command (group 1)	Parameter <i>0x84 Rx command (teach)</i>	Write access: 01 10 00 84 00 02 04 03 00 00 00 FA 78 Response to write access: 01 10 00 84 00 02 01 E1

Example: Deactivation/resetting of auto blanking

Blanking area configuration (group 8)	Parameter <i>0x4C configuration of blanking areas</i>	Write access: 01 10 00 4C 00 0D 1A 00 01 00 00 01 00 01 00 00 00 01 00 01 00 00 00 01 00 01 00 00 00 01 00 01 00 41 ED Response to write access: 01 10 00 4C 00 0D C0 1B
Command (group 1)	Parameter <i>0x84 command (teach)</i>	Write access: 01 10 00 84 00 02 04 03 00 00 00 FA 78 Response to write access: 01 10 00 84 00 02 01 E1

14.5 Example configuration – smoothing

14.5.1 Smoothing configuration (general)

↪ Make the following settings for smoothing.

Example: Smoothing of four interrupted beams

Smoothing settings	Parameter <i>Smoothing – less than i interrupted beams are ignored.</i>	= 4	(Beams are taken into account in the evaluation once there are four or more interrupted beams)
--------------------	---	-----	--

Example: Inverted smoothing of four interrupted beams

Smoothing settings	Parameter <i>Inverted smoothing - less than i free beams are ignored.</i>	= 4	(Beams are taken into account in the evaluation once there are four or more free beams)
--------------------	---	-----	---

14.5.2 Configuration of smoothing via IO-Link interface

↪ Assign the desired value for smoothing.

Example: Smoothing of four interrupted beams

General configuration (group 4)	Index 71, bit offset 8:	= 4	(Beams are taken into account in the evaluation once there are four or more interrupted beams)
--	-------------------------	-----	--

Example: Inverted smoothing of four interrupted beams

General configuration (group 4)	Index 71, bit offset 0:	= 4	(Beams are taken into account in the evaluation once there are four or more free beams)
--	-------------------------	-----	---

14.5.3 Configuration of smoothing via CANopen interface

↪ Assign the desired value for smoothing.

Example: Smoothing of four interrupted beams

General configuration (module 3)	Index 2100 sub 03: = 4	(Beams are taken into account in the evaluation once there are four or more interrupted beams)
---	------------------------	--

Example: Inverted smoothing of four interrupted beams

General configuration (module 3)	Index 2100 sub 4: = 4	(Beams are taken into account in the evaluation once there are four or more free beams)
---	-----------------------	---

14.5.4 Configuration of smoothing via Profibus interface

↳ Assign the desired value for smoothing.

Example: Smoothing of four interrupted beams

General settings (module 8)	Parameter <i>Smoothing</i> : = 4	(Beams are taken into account in the evaluation once there are four or more interrupted beams)
------------------------------------	----------------------------------	--

Example: Inverted smoothing of four interrupted beams

General settings (module 8)	Parameter <i>Inverted smoothing</i> : = 4	(Beams are taken into account in the evaluation once there are four or more free beams)
------------------------------------	---	---

14.5.5 Configuration of smoothing via RS 485 Modbus interface

↳ Assign the desired value for smoothing

Example: Smoothing of four interrupted beams

General settings/smoothing (group 4)	Parameter <i>0x47 smoothing</i>	Write access: 01 10 00 47 00 02 04 00 00 04 01 75 79 Response to write access: 01 10 00 47 00 02 F1 DD
---	---------------------------------	---

Example: Inverted smoothing of four interrupted beams

General settings/smoothing (group 4)	Parameter <i>0x47 smoothing</i>	Write access: 01 10 00 47 00 02 04 00 00 01 04 B6 2A Response to write access: 01 10 00 47 00 02 F1 DD
---	---------------------------------	---

14.6 Example configuration - Cascading

14.6.1 Configuration of a cascading arrangement (general)

The following figure shows an example for a timing sequence of a cascading arrangement with three light curtains.

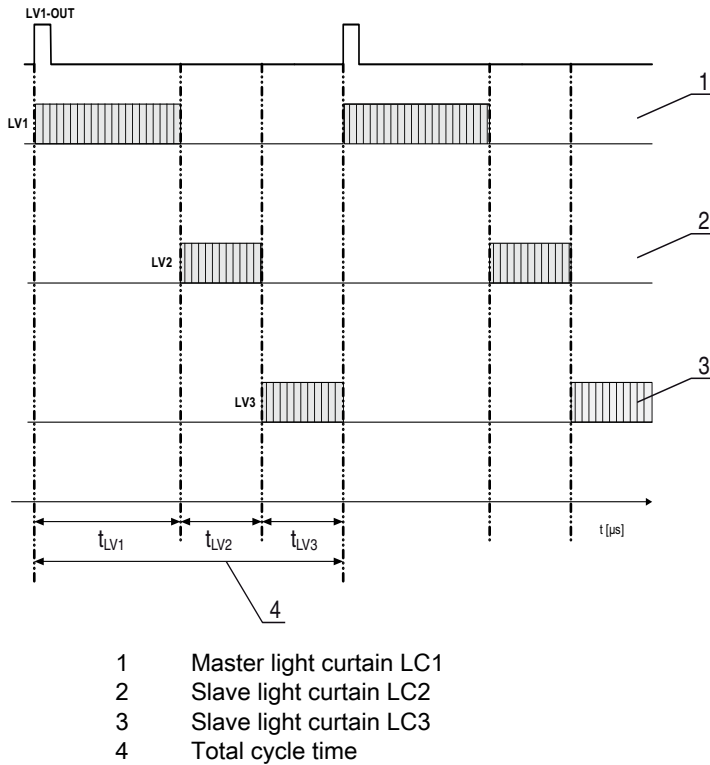

Figure 14.1: Example: cascading with three light curtains

Configuring light curtain 1:

Configure the trigger settings (triggered, master, total cycle time).

Cascading configuration	
Cascading	1: Active Notice: With cascading operation, the master must also be set to 1 (active)!
Function type	1: Master (sends trigger signal)
Master cycle time	Total cycle time (= sum of cycle times of the light curtains LC1+LC2+LC3) duration of a TRIGGER cycle in ms

Configure the digital IOs (pin 5) settings.

Digital IO1 (pin 5) settings	
Pin 5 - Input/output selection	1: Output
Pin 5 - Switching behavior	0: Light switching
Pin 5 - Output function	3: Trigger output

Configuring light curtain 2:

Configure the trigger settings (triggered, slave, delay time).

Cascading configuration	
Cascading	1: Active Notice: With cascading operation, the master must also be set to 1 (active)!
Function type	0: Slave (expects trigger signal)
Delay time Trigger → Scan [us]	Enter cycle time of light curtain 1 (LC1)

Configure the digital IOs (pin 5) settings.

Digital IO1 (pin 5) settings	
Pin 5 - Input/output selection	1: Input
Pin 5 - Switching behavior	0: Light switching
Pin 5 - Output function	1: Trigger input

Configuring light curtain 3:

↳ Configure the trigger settings (triggered, slave, delay time).

Cascading configuration	
Cascading	1: Active Notice: With cascading operation, the master must also be set to 1 (active)!
Function type	0: Slave (expects trigger signal)
Delay time Trigger → Scan [us]	Enter cycle time of light curtain 1 and light curtain 2 (= sum of cycle times of light curtains LC1+LC2)

↳ Configure the digital IOs (pin 5) settings.

Digital IO1 (pin 5) settings	
Pin 5 - Input/output selection	1: Input
Pin 5 - Switching behavior	0: Light switching
Pin 5 - Output function	1: Trigger input

14.6.2 Configuration of a cascading arrangement via IO-Link interface

CML700i frame arrangement for cascading with IO-Link interface wiring

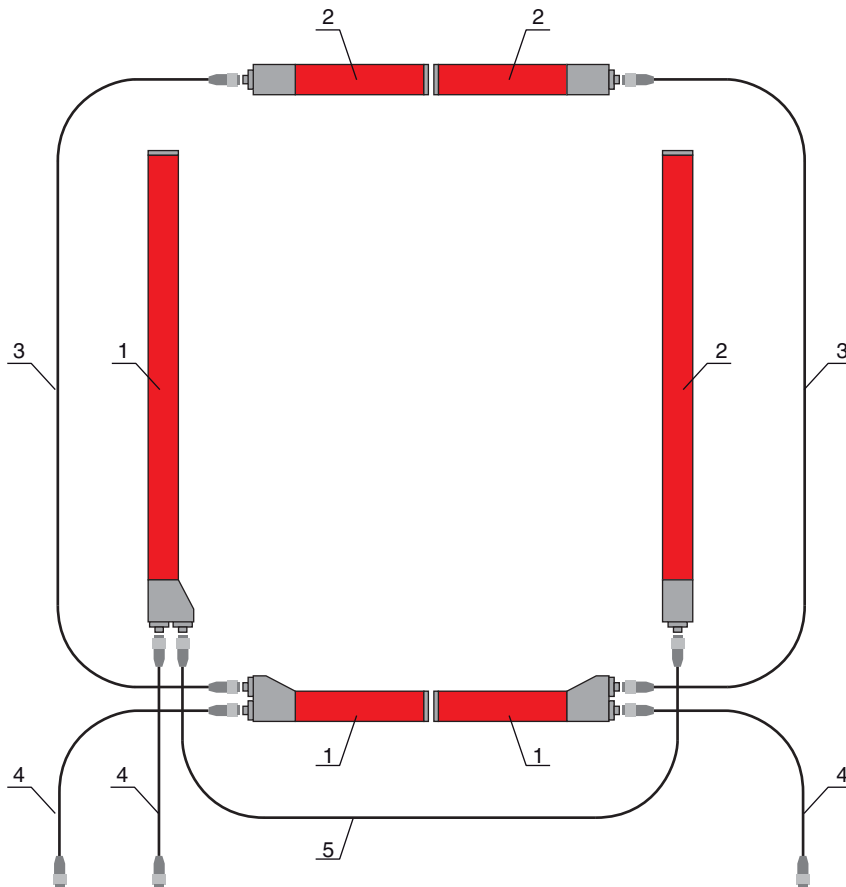

- 1 Receiver
- 2 Transmitter
- 3 Interconnection cable 5 m, see table 20.11
- 4 Connection cable 5 m, see table 20.3
- 5 Interconnection cable 2 m, see table 20.11

Configuring light curtain 1:

↪ Configure the trigger settings (triggered, master, total cycle time).

Cascading configuration (group 7)	Index 73, bit offset 56 = 1 (cascading: active) Notice: With cascading operation, the master must also be set to 1 (active)!
	Index 73, bit offset 48 = 1 (function type: master - sends trigger signal)
	Index 73, bit offset 32 (master cycle time: total cycle time of all light curtains (LC1+LC2+LC3)) duration of a TRIGGER cycle in ms

↪ Configure the digital IOs (pin 5) settings.

Digital IO1 (pin 5) settings (group 10)	Index 81, bit offset 24 = 0 (pin 5 - input/output selection: output)
	Index 81, bit offset 16 = 0 (pin 5 - switching behavior: light switching)
	Index 81, bit offset 00 = 3 (pin 5 - output function: trigger output)

Configuring light curtain 2:

↪ Configure the trigger settings (triggered, slave, delay time).

Cascading configuration (group 7)	Index 73, bit offset 56 = 1 (cascading: active) Notice: With cascading operation, the master must also be set to 1 (active)!
	Index 73, bit offset 48 = 0 (function type: slave - expects trigger signal)
	Index 73, bit offset 00 (delay time Trigger → Scan [µs]: enter cycle time of light curtain 1 (LC1))

↳ Configure the digital IOs (pin 5) settings.

Digital IO1 (pin 5) settings (group 10)	Index 81, bit offset 24 = 1	(pin 5 - input/output selection: input)
	Index 81, bit offset 16 = 0	(pin 5 - switching behavior: light switching)
	Index 81, bit offset 08 = 1	(pin 5 - output function: trigger input)

Configuring light curtain 3:

↳ Configure the trigger settings (triggered, slave, delay time).

Cascading configuration (group 7)	Index 73, bit offset 56 = 1	(cascading: active) Notice: With cascading operation, the master must also be set to 1 (active)!
	Index 73, bit offset 48 = 0	(function type: slave - expects trigger signal)
	Index 73, bit offset 32	(delay time Trigger → Scan [µs]: enter cycle time of light curtain 1 and light curtain 2 (= sum of the cycle times of light curtains LC1+LC2))

↳ Configure the digital IOs (pin 5) settings.

Digital IO1 (pin 5) settings (group 10)	Index 81, bit offset 24 = 1	(pin 5 - input/output selection: input)
	Index 81, bit offset 16 = 0	(pin 5 - switching behavior: light switching)
	Index 81, bit offset 08 = 1	(pin 5 - output function: trigger input)

14.6.3 Configuration of a cascading arrangement via CANopen interface

CML700i frame arrangement for cascading with CANopen interface wiring

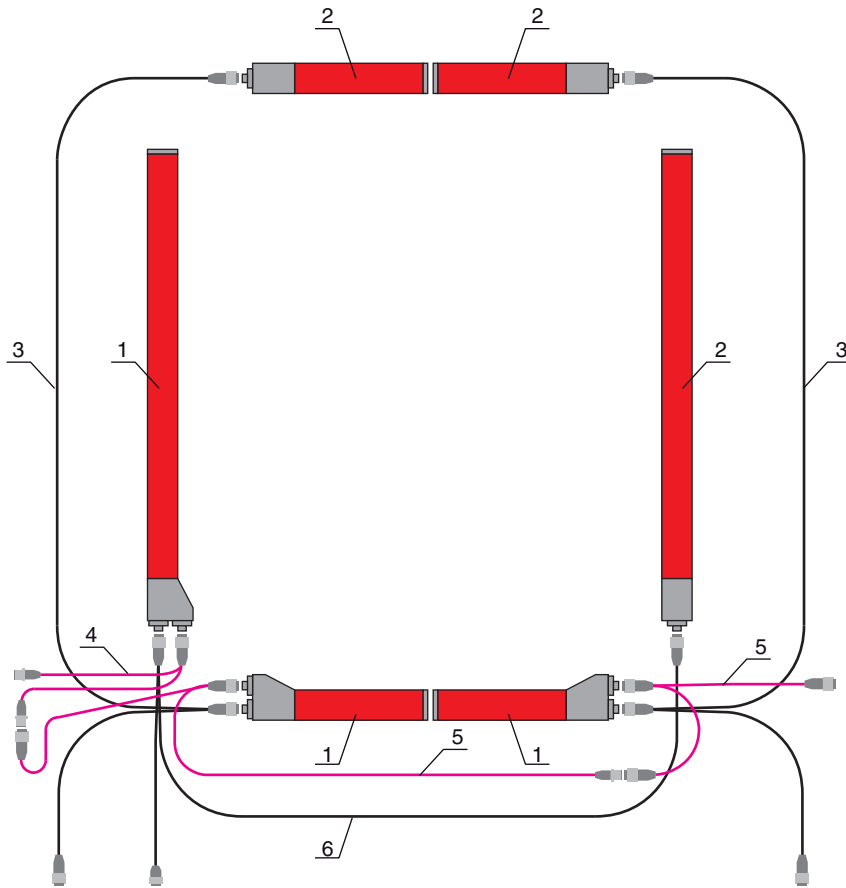

- 1 Receiver
- 2 Transmitter
- 3 Y-connection and interconnection cable, 0.15 m/5 m, see table 20.7
- 4 Y-CAN fieldbus interconnection cable, 0.25 m/0.35 m, see table 20.9
- 5 Y-CAN fieldbus interconnection cable, 0.25 m/5 m, see table 20.9
- 6 Y-connection and interconnection cable, 0.15 m/2 m, see table 20.7

Configuring light curtain 1:

↪ Configure the trigger settings (triggered, master, total cycle time).

Cascading configuration (module 12)	Index 0x2102 sub 01 = 1 (cascading: active) Notice: With cascading operation, the master must also be set to 1 (active)!
	Index 0x2102 sub 02 = 1 (function type: master - sends trigger signal)
	Index 0x2102 sub 05 (master cycle time: total cycle time of all light curtains (LC1+LC2+LC3)) duration of a trigger cycle in ms

↪ Configure the digital IOs (pin 5) settings.

Switching level of the inputs/outputs (module 10)	Index 0x2152 sub 04 = 1 (pin 5 - input/output selection: output)
	Index 0x2152 sub 03 = 0 (pin 5 - switching behavior: light switching)
	Index 0x2152 sub 01 = 3 (pin 5 - output function: trigger output)

Configuring light curtain 2:

↪ Configure the trigger settings (triggered, slave, delay time).

Cascading configuration (module 12)	Index 0x2102 sub 01 = 1 (cascading: active) Notice: With cascading operation, the master must also be set to 1 (active)!
	Index 0x2102 sub 02 = 0 (function type: slave - expects trigger signal)
	Index 0x2102 sub 03 (delay time Trigger → Scan [µs]: enter cycle time of light curtain 1 (LC1))

↪ Configure the digital IOs (pin 5) settings.

Switching level of the inputs/outputs (module 10)	Index 0x2152 sub 04	= 1	(pin 5 - input/output selection: input)
	Index 0x2152 sub 03	= 0	(pin 5 - switching behavior: light switching)
	Index 0x2152 sub 02	= 1	(pin 5 - input function: trigger input)

Configuring light curtain 3:

↪ Configure the trigger settings (triggered, slave, delay time).

Cascading configuration (module 12)	Index 0x2102 sub 01	= 1	(cascading: active) Notice: With cascading operation, the master must also be set to 1 (active)!
	Index 0x2102 sub 02	= 0	(function type: slave - expects trigger signal)
	Index 0x2102 sub 03		(delay time Trigger → Scan [µs]: enter cycle time of light curtain 1 and light curtain 2 (= sum of the cycle times of light curtains LC1+LC2))

↪ Configure the digital IOs (pin 5) settings.

Switching level of the Inputs/outputs (module 10)	Index 0x2152 sub 04	= 1	(pin 5 - input/output selection = input)
	Index 0x2152 sub 03	= 0	(pin 5 - switching behavior = light switching)
	Index 0x2152 sub 02	= 1	(pin 5 - input function = trigger input)

14.6.4 Configuration of a cascading arrangement via Profibus interface

CML700i frame arrangement for cascading with Profibus interface wiring

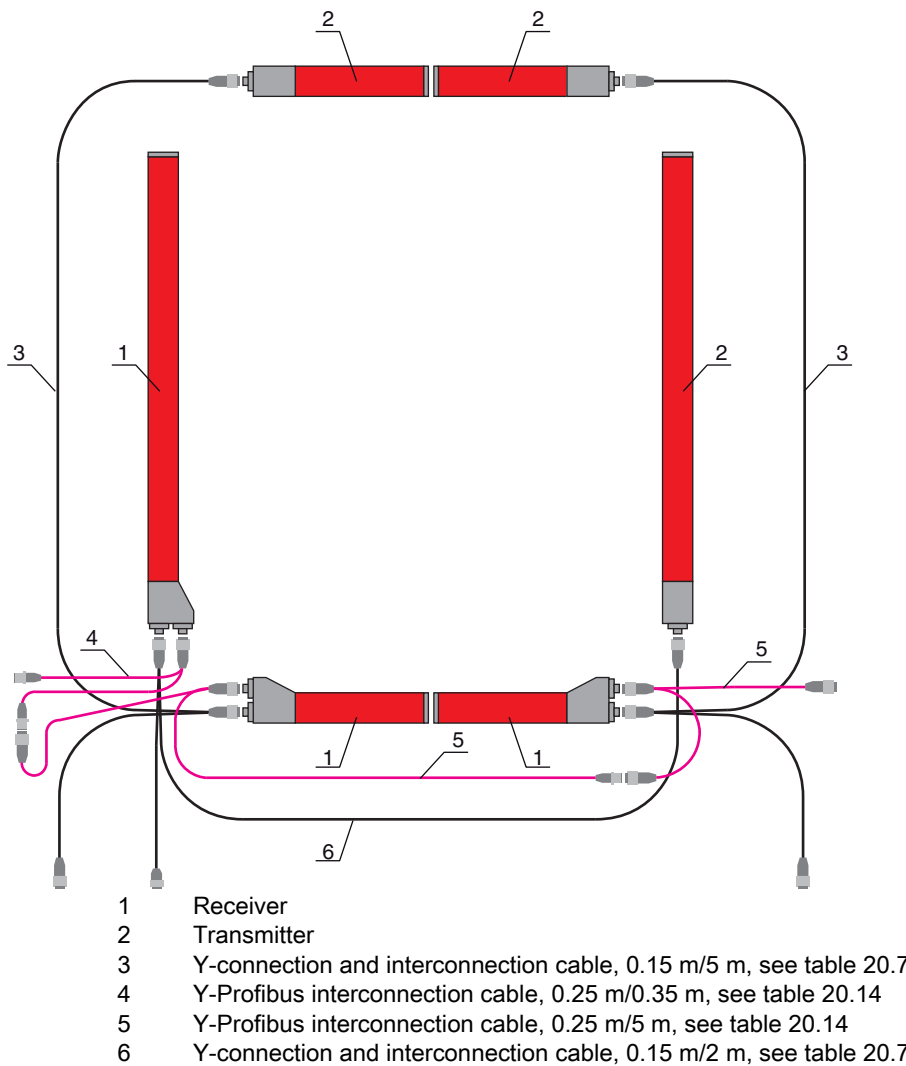

Configuring light curtain 1:

↪ Configure the trigger settings (triggered, master, total cycle time).

Cascading configuration (module 14)	Parameter <i>Cascading</i> = 1 (active) Notice: With cascading operation, the master must also be set to 1 (active)!
	Parameter <i>Function type</i> = 1 (master - sends trigger signal)
	Parameter <i>Master cycle time [ms]</i> (total cycle time of all light curtains (LC1+LC2+LC3)) duration of a TRIGGER cycle in ms

↪ Configure the digital IOs (pin 5) settings.

Digital IO1 (pin 5) settings (module 12)	Parameter <i>Pin 5 - Input/output selection</i> = 0 (output)
	Parameter <i>Pin 5 - Input/output selection</i> = 0 (light switching)
	Parameter <i>Pin 5 - Output function</i> = 3 (trigger output)

Configuring light curtain 2:

↪ Configure the trigger settings (triggered, slave, delay time).

Cascading configuration (module 14)	Parameter <i>Cascading</i> = 1 (active) Notice: With cascading operation, the master must also be set to 1 (active)!
	Parameter <i>Function type</i> = 0 (slave - expects trigger signal)
	Parameter <i>Delay time Trigger → Scan [μs]</i> (enter cycle time of light curtain 1 (LC1))

↪ Configure the digital IOs (pin 5) settings.

Digital IO1 (pin 5) settings (module 12)	Parameter <i>Pin 5 - Input/output selection</i> = 1 (input)
	Parameter <i>Pin 5 - Input/output selection</i> = 0 (light switching)
	Parameter <i>Pin 5 - Input function</i> = 1 (trigger input)

Configuring light curtain 3:

↪ Configure the trigger settings (triggered, slave, delay time).

Cascading configuration (module 14)	Parameter <i>Cascading</i> = 1 (active) Notice: With cascading operation, the master must also be set to 1 (active)!
	Parameter <i>Function type</i> = 0 (slave - expects trigger signal)
	Parameter <i>Delay time Trigger → Scan [μs]</i> (enter cycle time of light curtain 1 and light curtain 2 (= sum of cycle times of light curtains LC1+LC2))

↪ Configure the digital IOs (pin 5) settings.

Digital IO1 (pin 5) settings (module 12)	Parameter <i>Pin 5 - Input/output selection</i> = 1 (input)
	Parameter <i>Pin 5 - Switching behavior</i> = 0 (light switching)
	Parameter <i>Pin 5 - Output function</i> = 1 (trigger input)

14.6.5 Configuration of a cascading arrangement via RS 485 Modbus interface

CML700i frame arrangement for cascading with RS 485 Modbus interface wiring

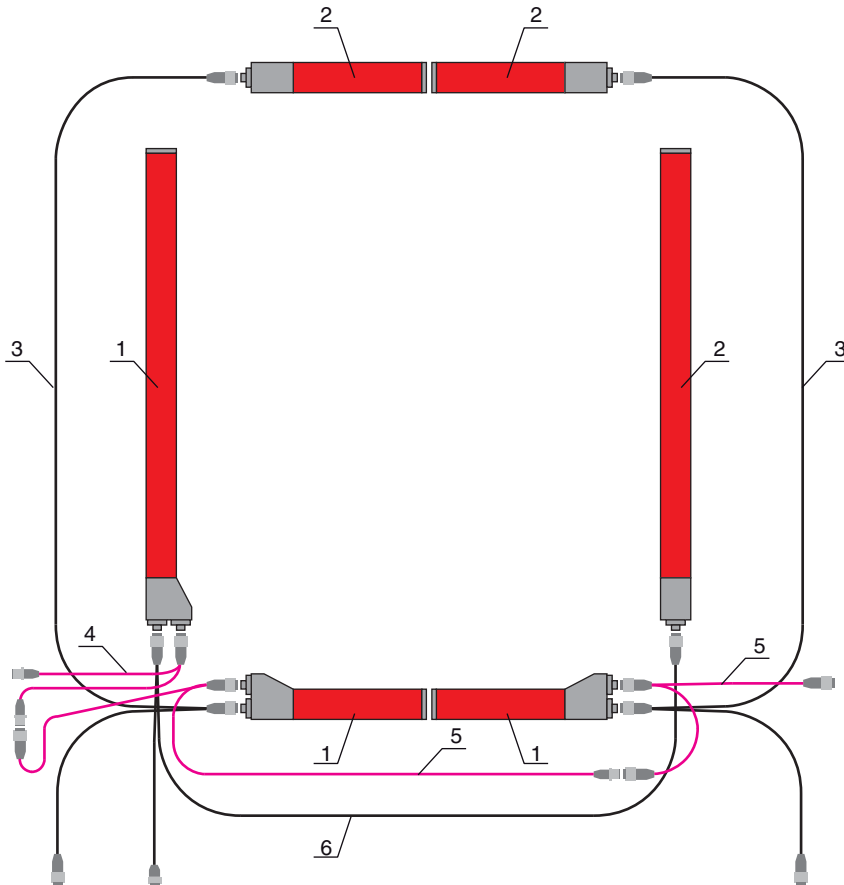

- 1 Receiver
- 2 Transmitter
- 3 Y-connection and interconnection cable, 0.15 m/5 m, see table 20.7
- 4 Y-Modbus interconnection cable, 0.25 m/0.35 m, see table 20.14
- 5 Y-Modbus interconnection cable, 0.25 m/5 m, see table 20.14
- 6 Y-connection and interconnection cable, 0.15 m/2 m, see table 20.7

Configuring light curtain 1:

↪ Configure the trigger settings (triggered, master, total cycle time (e.g., 255 ms)).

Cascading information (group 7)	Parameter <i>0x49 cascading</i>	Write access: 01 10 00 49 00 04 08 01 01 F4 01 64 00 FF 00 0C 21
		Response to write access: 01 10 00 49 00 04 10 1C

↪ Configure the digital IOs (pin 5 = trigger output) settings.

Digital IOs (pin 5) settings (group 10)	Parameter <i>0x51 Digital IO Pin 5 Settings</i>	Write access: 01 10 00 51 00 02 04 03 00 00 00 37 1B
		Response to write access: 01 10 00 51 00 02 10 19

Configuring light curtain 2:

↪ Configure the trigger settings (triggered, slave, delay time (e.g., 10 ms = 10,000 µs)).

Cascading information (group 7)	Parameter <i>0x49 cascading</i>	Write access: 01 10 00 49 00 04 08 01 00 10 27 64 00 01 00 42 A2
		Response to write access: 01 10 00 49 00 04 10 1C

↪ Configure the digital IOs (pin 5) settings.

Digital IOs (pin 5) settings (group 10)	Parameter <i>0x51 Digital IO Pin 5 Settings</i>	Write access: 01 10 00 51 00 02 04 00 01 00 01 A7 5F Response to write access: 01 10 00 51 00 02 10 19
--	---	---

Configuring light curtain 3:

↳ Configure the trigger settings (triggered, slave, delay time (e.g., 25 ms = 25,000 µs)).

Cascading information (group 7)	Parameter <i>0x49 cascading</i>	Write access: 01 10 00 49 00 04 08 01 00 61 A8 64 00 01 00 1D 9C Response to write access: 01 10 00 49 00 04 10 1C
--	---------------------------------	---

↳ Configure the digital IOs (pin 5) settings.

Digital IOs (pin 5) settings (group 10)	Parameter <i>0x51 Digital IO Pin 5 Settings</i>	Write access: 01 10 00 51 00 02 04 00 01 00 01 A7 5F Response to write access: 01 10 00 51 00 02 10 19
--	---	---

15 Connecting to a PC – *Sensor Studio*

The *Sensor Studio* configuration software – in combination with an IO-Link USB master – provides a graphical user interface for the operation, configuration and diagnosis of sensors with IO-Link configuration interface (IO-Link devices), independent of the selected process interface.

Each IO-Link device is described by a corresponding IO Device Description (IODD file). After importing the IODD file into the configuration software, the IO-Link device connected to the IO-Link USB master can be operated, configured and checked – conveniently and in multiple languages. An IO-Link device that is not connected to the PC can be configured offline.

Configurations can be saved and reopened as projects for transferring back to the IO-Link device at a later time.



Only use the *Sensor Studio* configuration software for products manufactured by **Leuze electronic**.

The *Sensor Studio* configuration software is offered in the following languages: German, English, French, Italian and Spanish.

The FDT frame application of the *Sensor Studio* supports all languages; all languages may not be supported in the IO-Link device DTM (Device Type Manager).

The *Sensor Studio* configuration software is designed according to the FDT/DTM concept:

- Make individual configuration settings for the light curtain in the Device Type Manager (DTM).
- The individual DTM configurations of a project can be called up via the frame application of the Field Device Tool (FDT).
- Communication DTM: IO-Link USB master
- Device DTM: IO-Link device/IODD for CML 700i

NOTICE

Configuration changes only via the control and the fieldbus interface!

↪ **Always** perform the configuration for process mode via the control and, if applicable, the fieldbus interface.

In process mode, only the configuration conveyed via the control is active. The configuration changes made via *Sensor Studio* are only active in process mode if they were previously transmitted 1:1 to the control.

Procedure for the installation of the software and hardware:

- ↪ Install the *Sensor Studio* configuration software on the PC.
- ↪ Install the driver for the IO-Link USB master on the PC.
- ↪ Connect the IO-Link USB master to the PC.
- ↪ Connect the CML 700i (IO-Link device) to the IO-Link USB master.
- ↪ Install IO-Link device DTM with IODD file for CML 700i in the *Sensor Studio* FDT frame.

15.1 System requirements

To use the *Sensor Studio* configuration software, you need a PC or laptop with the following specifications:

Table 15.1: *System requirements for Sensor Studio installation*

Operating system	Windows 7 Windows 8
Computer	<ul style="list-style-type: none"> • Processor type: 1 GHz or higher • USB interface • CD drive • Main memory <ul style="list-style-type: none"> • 1 GB RAM (32-bit operating system) • 2 GB RAM (64-bit operating system) • Keyboard and mouse or touchpad
Graphics card	DirectX 9 graphic device with WDDM 1.0 or higher driver
Additionally required capacity for <i>Sensor Studio</i> and IO-Link device DTM	350 MB hard drive memory 64 MB main memory



Administrator privileges on the PC are necessary for installing *Sensor Studio*.

15.2 Installing *Sensor Studio* configuration software and IO-Link USB master



The installation of the *Sensor Studio* configuration software is done via supplied data carrier **Sensor Studio & IO-Link USB master**.

For subsequent updates, you can find the most recent version of the *Sensor Studio* configuration software on the Internet at www.leuze.com

15.2.1 Installing the *Sensor Studio* FDT frame

NOTICE

First install the software!

⚡ Do not yet connect the IO-Link USB master to the PC.
First install the software.



If FDT frame software is already installed on your PC, you do not need the *Sensor Studio* installation.

You can install the communication DTM (IO-Link USB master) and the device DTM (IO-Link device CML 700i) in the existing FDT frame.

⚡ Start the PC and insert the **Sensor Studio & IO-Link USB Master** data carrier.

The language selection menu starts automatically.

If the language selection menu does not start automatically, double-click the *start.exe* file.

⚡ Select a language for the interface text in the Installation Wizard and software.

The installation options are displayed.

⚡ Select **Leuze electronic Sensor Studio** and follow the instructions on the screen.

The Installation Wizard installs the software and places a shortcut on the desktop ().

15.2.2 Installing drivers for IO-Link USB master

☞ Select the **IO-Link USB Master** installation option and follow the instruction on the screen. The Installation Wizard installs the software and places a shortcut on the desktop ().

15.2.3 Connecting IO-Link USB master to the PC

The light curtain is connected to the PC via the IO-Link USB master (see table 20.22).

☞ Connect the IO-Link USB master to the plug-in power supply unit or the mains supply.



Included in the delivery contents of the IO-Link USB master is a USB interconnection cable for connecting the PC to the IO-Link USB master as well as a plug-in power supply unit and a short description.

The mains supply of the IO-Link USB master via the plug-in power supply unit is only activated if IO-Link USB master and PC are connected via the USB interconnection cable.

☞ Connect the PC to the IO-Link USB master.

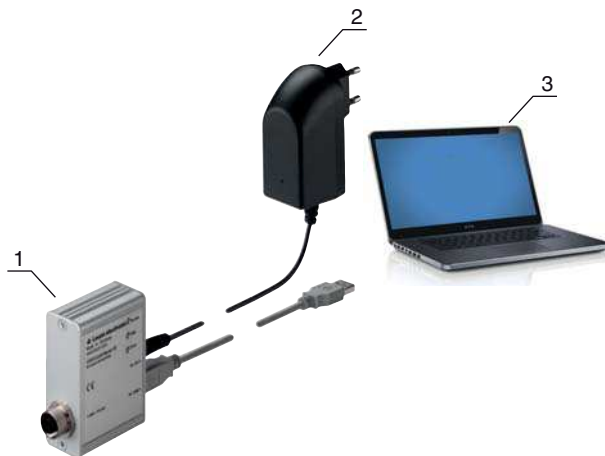

- 1 IO-Link USB master
- 2 Plug-in power supply unit
- 3 PC

Figure 15.1: PC connection via the IO-Link USB master

☞ The **wizard for searching for new hardware** starts and installs the driver for the IO-Link USB master on the PC.

15.2.4 Connect the IO-Link USB master to the light curtain

Prerequisites:

- IO-Link USB master and PC are connected via the USB interconnection cable.
- IO-Link USB master is connected to the mains supply with the plug-in power supply unit.

NOTICE

Connect the plug-in power supply unit for IO-Link USB master!

☞ To connect a light curtain, the plug-in power supply unit must be connected to the IO-Link USB master and the mains supply.

The voltage supply via the USB interface of the PC is permissible only for IO-devices with a current consumption of up to 40 mA at 24 V.



Included in the delivery contents of the IO-Link USB master is a USB interconnection cable for connecting the PC to the IO-Link USB master as well as a plug-in power supply unit and a short description.

The voltage supply of the IO-Link USB master and the light curtain via the plug-in power supply unit is only activated if IO-Link USB master and PC are connected via the USB interconnection cable.

↪ Connect the IO-Link USB master to the receiver.

↪ CML 700i with analog output or IO-Link interface:

Connect the IO-Link USB master to interface X1 on the receiver with the connection cable (see figure 15.2).

The connection cable is not included in the delivery contents and must be ordered separately if needed (see chapter 20.5).

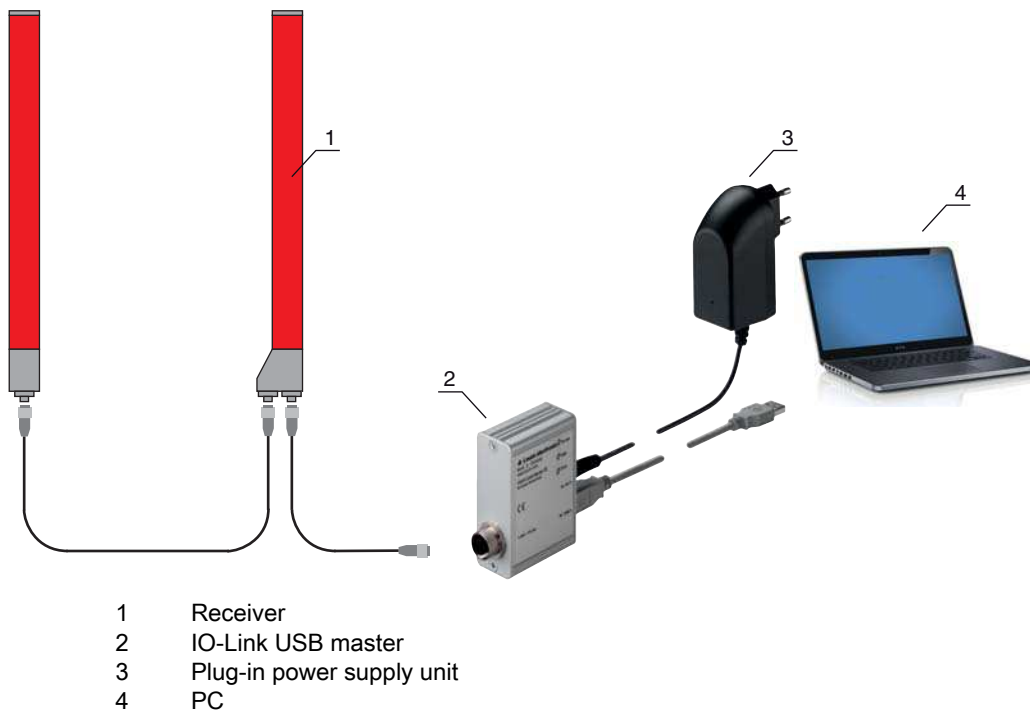
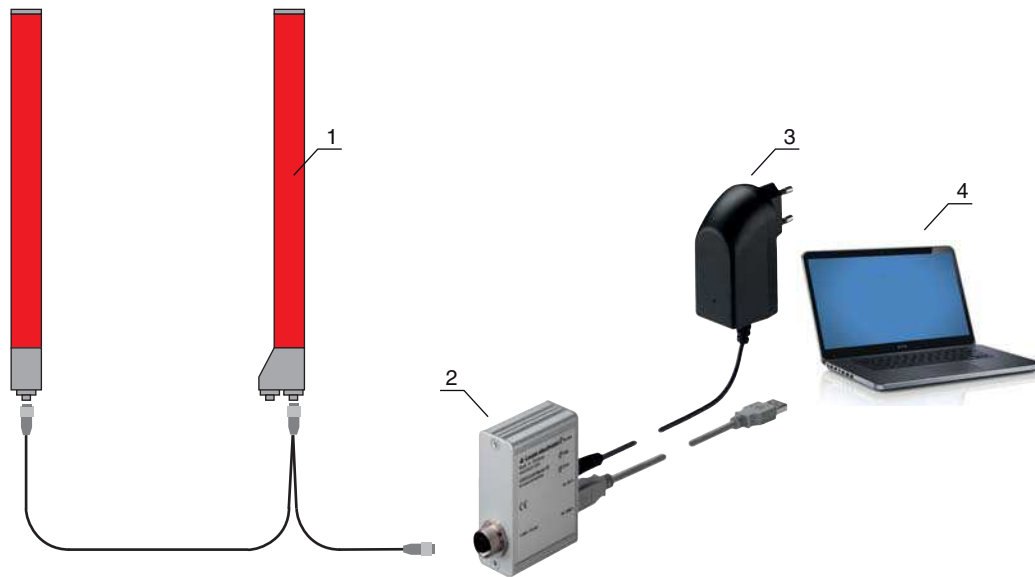

Figure 15.2: CML 700i (analog/IO-Link) connection to the IO-Link USB master

↪ CML 700i with Profibus, RS 485 Modbus, CANopen or IO-Link interface:

Connect the IO-Link USB master to the short end of the Y-connection cable (see figure 15.3).

If the Y-connection cable is too short to connect the IO-Link USB master, use a interconnection/synchronization cable to extend the cable (to be ordered separately, see table 20.4).



- 1 CML 700i receiver
- 2 IO-Link USB master
- 3 Plug-in power supply unit
- 4 PC

Figure 15.3: CML 700i (fieldbus) connection to the IO-Link USB master

15.2.5 Installing the DTM and IODD

Prerequisites:

- The light curtain is connected to the PC via the IO-Link USB master.
- FDT frame and driver for IO-Link USB master are installed on the PC.

☞ Select the **IO-Link device DTM (User Interface)** installation option and follow the instructions on the screen.

The Installation Wizard installs the DTM and the IO Device Description (IODD) for the light curtain.



DTM and IODD for all IO-Link devices currently available from Leuze electronic are installed.

15.3 Starting the *Sensor Studio*

configuration software

Prerequisites:

- The light curtain has been mounted (see chapter 6) and connected (see chapter 7) correctly.
- The *Sensor Studio* configuration software is installed on the PC (see chapter 15.2 "Installing Sensor Studio configuration software and IO-Link USB master").
- The light curtain is connected to the PC via the IO-Link USB master (see chapter 15.2 "Installing Sensor Studio configuration software and IO-Link USB master").

☞ Start the *Sensor Studio* configuration software by double-clicking the *Sensor Studio* icon ().

The **Mode selection** of the Project Wizard is displayed automatically or under the **File** menu item.

☞ Select the **Device selection without communication connection (offline)** configuration mode and click on [Next].

The **Project Wizard** displays the **device selection** list of the configurable devices.

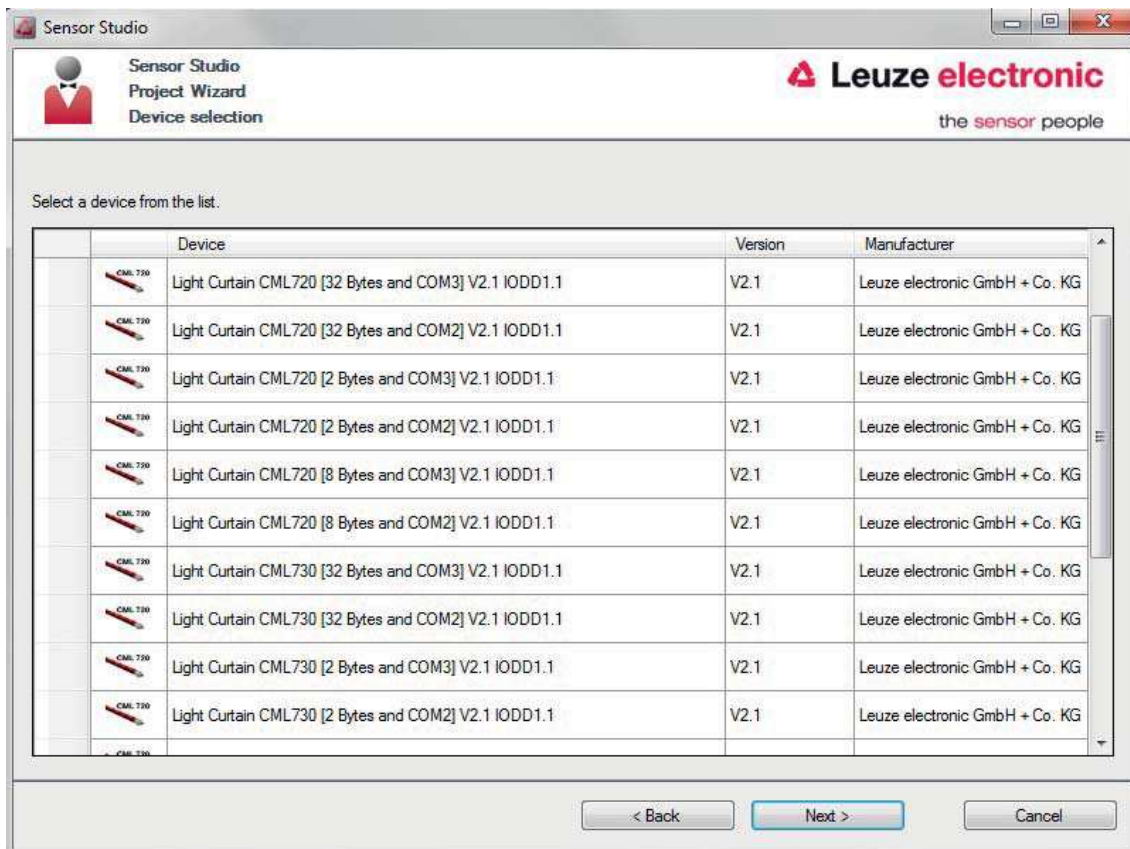

Figure 15.4: Device selection for CML 700i measuring light curtain

☞ Select the connected light curtain according to the configuration in the **device selection** and click on [Next].

In the **Device** description in the **Device selection** list, the values for the bit rate and PD length configuration parameters for the respective light curtain are listed. Factory settings on delivery:

Bit rate: COM2

PD length: 2 bytes

The device manager (DTM) of the connected light curtain starts with the offline view for the *Sensor Studio* configuration project.

☞ Establish the online connection to the connected light curtain.

In the *Sensor Studio* FDT frame, click on the [Establish connection with device] button ().

In the *Sensor Studio* FDT frame, click on the [Online parameters] button ().

The IO-Link USB master synchronizes with the connected light curtain and the current configuration data and process data are displayed in the device manager (DTM).

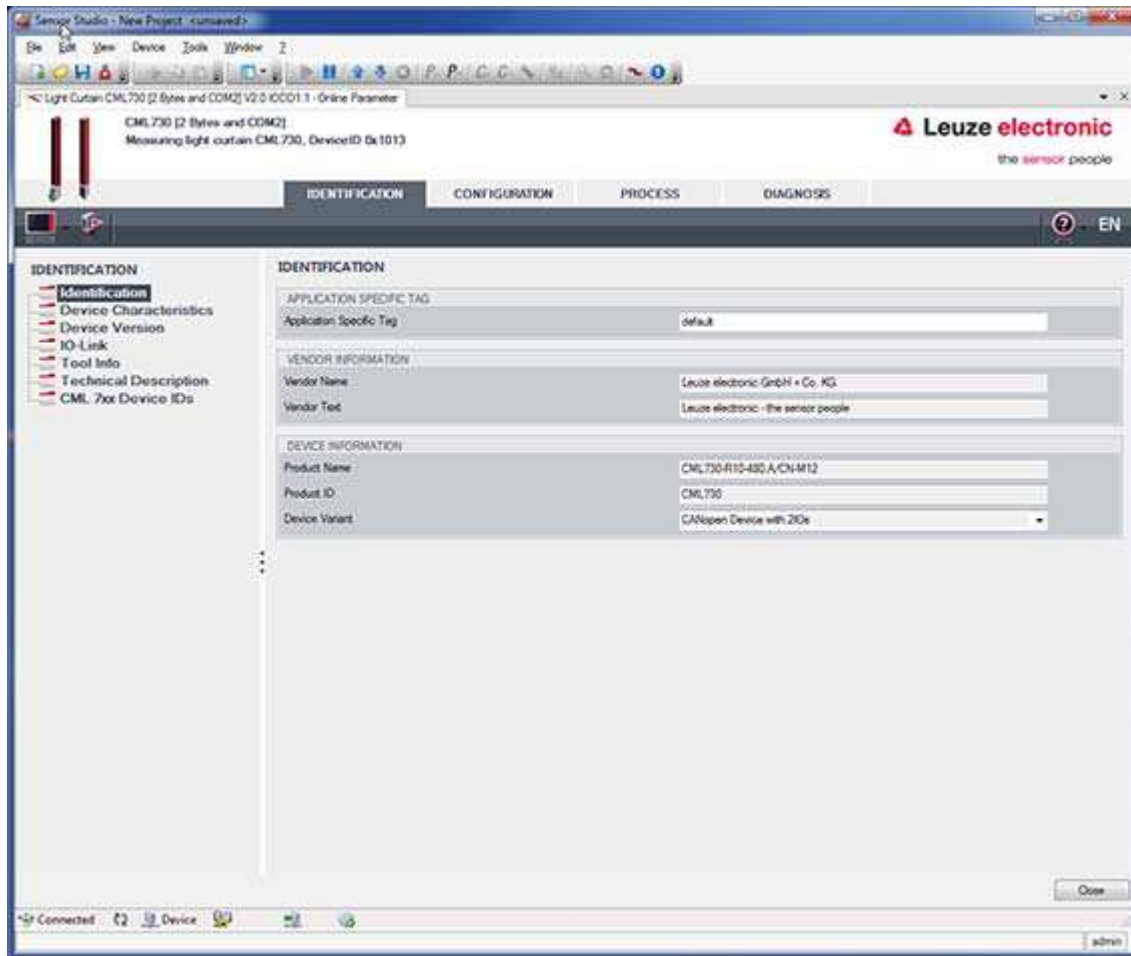

Figure 15.5: Configuration project: *Sensor Studio* device manager (DTM) for CML 700i

↪ The menus of the *Sensor Studio* device manager (DTM) can be used to change or read out the configuration of the connected light curtain.

The user interface of the *Sensor Studio* device manager (DTM) is largely self-explanatory.

The online help system provides information on the menu items and adjustment parameters. Select the **Help** menu item in the menu [?].

Error message when [establishing connection with the device]

If the device selected in the **Device selection** list of the *Sensor Studio* Project Wizard does not match the configuration (bit rate and PD length) of the connected light curtain, an error message is displayed.

Under **IDENTIFICATION > CxL-7XX Device IDs**, you will find a list with the assignment of the device IDs displayed in the error message to the **device** description in the **device selection** list.

↪ Change the device selection in the **Device selection** list according to the configuration (bit rate and PD length) of the connected light curtain.

Alternatively, you can set the configuration (bit rate and PD-length) of the light curtain in the receiver control panel corresponding to the device selection in the **Device selection** list.

↪ In the *Sensor Studio* FDT frame, click on the [Establish connection with device] button ().

15.4 Short description of the *Sensor Studio* configuration software

This chapter contains information and explanations on the individual menu items and adjustment parameters of the *Sensor Studio* configuration software and the device manager (DTM) for CML 700i measuring light curtains.



This chapter does not include a complete description of the *Sensor Studio* configuration software.

Complete information on the FDT frame menu and on the functions in the device manager (DTM) can be found in the online help system.

The device managers (DTM) for light curtains of the *Sensor Studio* configuration software have the following main menus and functions:

- *IDENTIFICATION* (see chapter 15.4.2)
- *CONFIGURATION* (see chapter 15.4.3)
- *PROCESS* see chapter 15.4.4
- *DIAGNOSIS* (see chapter 15.4.5)



The online help system displays information on the menu items and adjustment parameters for each function. Select the **Help** menu item in the menu [?]

15.4.1 FDT frame menu



You can find complete information on the FDT frame menu in the online help system. Select the **Help** menu item in the menu [?].

15.4.2 IDENTIFICATION function

- *Operating information*: Information on operating the device manager (DTM)
- *Technical description*: The available original operating instructions of the device in pdf format
- *CML-7XX*: Table with the assignment of device IDs to the **device** description in the **device selection** list in the *Sensor Studio* Project Wizard.

The information is needed if an error message is displayed when connecting with the device.

15.4.3 CONFIGURATION function

- *Save permanently*: Configuration changes via *Sensor Studio* are effective immediately but are lost if the device is de-energized.
With *Save permanently*, the configuration set via *Sensor Studio* is stored in non-volatile memory in the device.



NOTICE

Configuration for process mode only via the control!

↳ **Always** configure process mode via the control and, if applicable, the fieldbus interface.

In process mode, only the configuration conveyed via the control is active. The configuration changes made via *Sensor Studio* are only active in process mode if they were previously transmitted 1:1 to the control.

- *Teach*: The sensitivity of the teach event (see chapter 8.2 "Teaching the environmental conditions") can only be set via the *Sensor Studio* configuration software.
- *Upload device data set from device* (): The configuration is uploaded from the device to the device manager (DTM), e.g., to update the online view in *Sensor Studio* after the configuration was changed via the receiver control panel.
- *Upload device data set from device* () / *Synchronize with device* ():
 - If the [Upload device data set from device] button () is displayed in the device manager (DTM), the *Sensor Studio* display shows the current configuration of the light curtain.
 - If the [Synchronize with device] button () is displayed in the device manager (DTM), the *Sensor Studio* display is not consistent with the current configuration of the light curtain.

If parameters are changed in the device manager (DTM) that affect other parameters (e.g., if changing the beam mode causes the configured logical beams to change), the changes to these parameters are configured in the device – but are not yet displayed in the *Sensor Studio* display. Click on the [Synchronize with device] button () to synchronize the *Sensor Studio* display with the current configuration of the light curtain. Following successful synchronization, the [Upload device data set from device] button () is displayed in the device manager(DTM).

15.4.4 PROCESS function

- The *Process* function offers graphical visualizations of the process data of the connected light curtain.

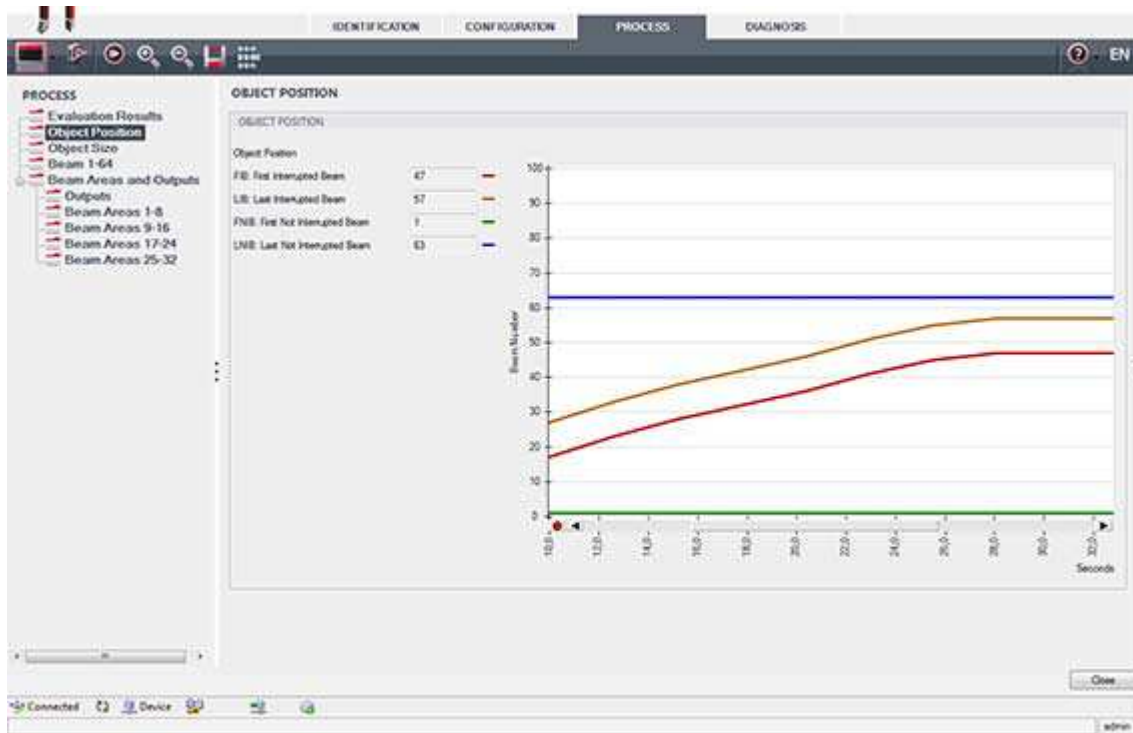



Figure 15.6: Graphical visualization: object position

- [Cyclical refresh] button (): Starts the cyclical acquisition of the process data, which are graphically depicted under *Numerical display*, *Beam-stream display* and *Areas and outputs*. Each graphical display covers up to 300 seconds.
- *Beam-stream display*: Using the [Show or hide the graphical cursor] button (), you can move the graphical cursor in the visualization, e.g., to evaluate the time difference between two events.

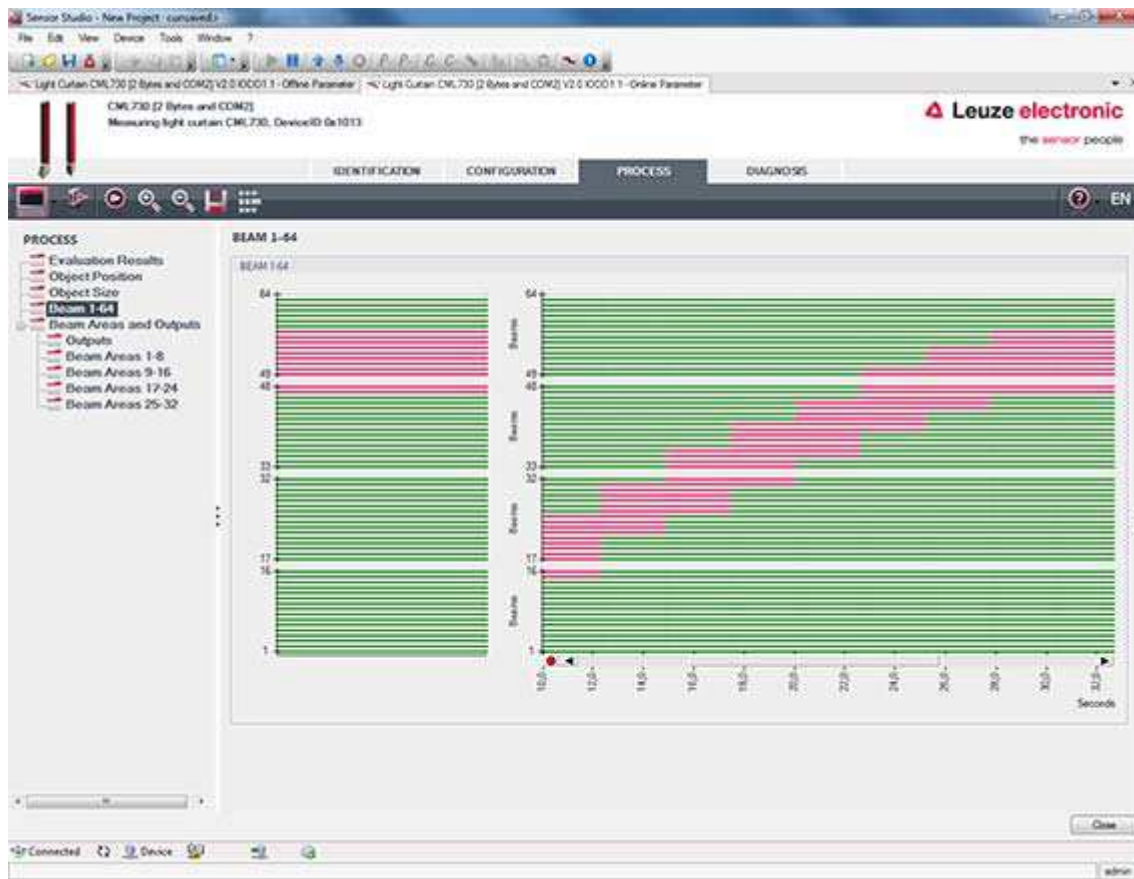

Figure 15.7: Graphical visualization: Beam-stream display

15.4.5 DIAGNOSIS function

The *DIAGNOSIS* function offers the following commands.

- Reset device, i.e., restart the connected light curtain
- Store configuration in non-volatile memory (see chapter 15.4.3)

15.4.6 Exiting *Sensor Studio*

After completing the configuration settings, close the *Sensor Studio* configuration software

↳ Exit the program via **File > Exit**.

↳ Save the configuration settings as a configuration project on the PC.

You can open the configuration project again at later time via **File > Open** or via the *Sensor Studio Project Wizard* ().

16 Troubleshooting

16.1 What to do in case of error?

After switching on the light curtain, display elements (see chapter 3.4) assist in checking the proper function and troubleshooting.

In case of error, you can determine the error from the LED displays. With the error message you can determine the cause of the error and initiate measures to rectifying it.

NOTICE
If the light curtain responds with an error display, you will often be able to eliminate the cause yourself!
↳ Switch off the system and leave it switched off.
↳ Analyze and eliminate the cause of the fault using the following table.
↳ If you are unable to rectify the fault, contact the Leuze electronic branch responsible for you or call the Leuze electronic customer service (see chapter 18 "Service and support").

16.2 Operating displays of the LEDs

Table 16.1: Receiver LED displays - state and causes

LED green	LED yellow	State	Possible cause
ON (continuous light)	-	Sensor ready	
OFF	OFF	Sensor not ready	Interruption of the operating voltage; Light curtain in start-up phase
OFF	Flashing (15 Hz)	Missing function reserve	Soiling of the lens covers Misalignment of transmitter or receiver Operating range exceeded
Flashing synchronously (3 Hz)		Teach running	
Flashing synchronously (9 Hz)		Teach error	Soiling of the lens covers Operating range exceeded
Flashing alternately (9 Hz)		System error	No connection between transmitter and receiver Operating voltage too low Receiver is not compatible with the transmitter

Table 16.2: LED displays - causes and measures

Faults	Possible cause	Measure
Teach error	Soiling of the lens covers Poor alignment of transmitter and receiver	Clean the lens cover on the receiver and on the transmitter. Check alignment.
Function reserve too low	Poor alignment of transmitter and receiver Soiling of the lens covers	Adjust alignment. Test with shorter distance between transmitter and receiver. Clean the lens cover on the receiver and on the transmitter.
Alignment signal too low	Poor alignment of transmitter and receiver Soiling of the lens covers	Adjust alignment. Test with shorter distance between transmitter and receiver. Clean the lens cover on the receiver and on the transmitter.
Outputs are not active or change their state without a contour change in the measurement field	Configuration data is read or written	End configuration communication.



During teaching, the system checks whether the signals of all beams are within a certain corridor. If there are considerable deviations in the signal strength, this results in a teaching error and is indicated on the LEDs. The cause may be partial soiling of the lens cover.

Measure: clean the lens covers on the transmitter and receiver!

16.3 Error codes in the display

The following error messages can be output in the form of error codes in the device display.

Table 16.3: Normal mode

Error code	Description
RxS 0x0100	CxL in normal mode, start-up phase still running
RxS 0x0180	CxL reconfigures itself after a configuration. Process data is invalid.
RxS 0x0190	The measurement system is not active (after a stop command or if the first trigger pulse is missing).
RxS 0x0200	The “Leuze AutoControl ACON function” has detected soiling.
RxS 0x0300	Teach parameters have been changed (teaching must be done) or default values are active.
RxS 0x0FFF	CxL shuts down. Process data is invalid.

Table 16.4: Warnings

Error code	Description	Possible cause (s)
RxS 0x1000	Device in teach mode, no new process data available	<ul style="list-style-type: none"> • Distance between transmitter and receiver too large or too small • Poor alignment • Soiling • Extraneous light, especially mutual interference • Beams are interrupted, but blanking is deactivated • The maximum number of blanking areas is not sufficient • The number of beams to be blanked is greater than or equal to the number of all logical beams
RxS 0x1100 RxS 0x11xy	Teaching error The device could not end teach, no new process data available	
RxS 0x111x	Blanking error	
RxS 0x112x	Error due to weak signal Individual beams do not reach the minimum reception level	
RxS 0x113x	Internal error Device has reached the power limit	

Table 16.5: Errors (can be corrected)

Error code	Description	Measures
RxS 0x2000	No communication possible between transmitter and receiver.	Check cable.
RxS 0x2001	Receiver/transmitter inconsistency. The receiver is not compatible with the transmitter.	Replace transmitter.
RxS 0x2100	The supply voltage is not sufficient.	Check voltage supply.
RxS 0x2200	EEPROM data corrupt.	Reset device to factory settings.
RxS 0x23xy	Configuration error. xy gives information on the type of configuration error.	Contact service (see chapter 18). Reset device to factory settings. Check parameters and parameter relation.

Table 16.6: Serious errors (cannot be corrected)

Faults	Description	Measures
RxS 0x3000	Hardware error, no details available	Return device following consultation with Service department (see chapter 18)
RxS 0x3001	Hardware error, transmitter 9V supply	
RxS 0x3002	Hardware error, transmitter 5V supply	
RxS 0x3003	Hardware error, receiver 5V supply	
RxS 0x3004	Hardware error, no Rx/Tx cascade	
RxS 0x3005	Hardware error, receiver cascade No receiver cascade or different LED number of transmitter and receiver	
RxS 0x3006	Hardware error, transmitter	
RxS 0x3007	Hardware error, inter-controller communication is interrupted	
RxS 0x3008	Hardware error, different number of diodes at transmitter and receiver	
RxS 0x3100 RxS 0x3101	Error in the factory settings. Can only be rectified by reprogramming the device firmware.	

17 Care, maintenance and disposal

17.1 Cleaning

In the event of dust build-up on the sensor:

- ↳ Clean the sensor with a soft cloth; use a cleaning agent (commercially available glass cleaner) if necessary.

NOTICE
Do not use aggressive cleaning agents!
↳ Do not use aggressive cleaning agents such as thinner or acetone for cleaning the light curtains. Use of improper cleaning agents can damage the lens cover.

17.2 Servicing

Usually, the light curtain does not require any maintenance by the operator.

Repairs to the device must only be carried out by the manufacturer.

- ↳ For repairs, contact your responsible Leuze electronic subsidiary or Leuze electronic customer service (see chapter 18).

17.2.1 Firmware update

A firmware update can only be performed by Leuze electronic customer service on-site or at the company headquarters.

- ↳ For firmware updates, contact your responsible Leuze electronic subsidiary or Leuze electronic customer service (see chapter 18).

17.3 Disposing

For disposal observe the applicable national regulations regarding electronic components.

18 Service and support

Defective devices are repaired in our service center competently and quickly. Leuze electronic offers you an extensive service packet to keep any necessary system downtimes to a minimum.

Our service center requires the following information:

- Customer number
- Part designation or part number
- Serial number or batch number
- Reason for return with description

Telephone number for 24-hour standby service:

+49 (0) 7021 573-0

Service hotline:

+49 (0) 7021 573-123

Monday to Thursday, 8.00 a.m. to 5.00 p.m. (UTC+1)

Friday, 8.00 a.m. to 4.00 p.m. (UTC+1)

E-mail:

service.detect@leuze.de

Repair service and returns:

Procedure and Internet form can be found at

www.leuze.com/repair

Return address for repairs:

Service Center

Leuze electronic GmbH + Co. KG

In der Braike 1

D-73277 Owen / Germany

19 Technical data

19.1 General specifications

Table 19.1: Optical data

Light source	LED (modulated light)
Wavelength	850 nm (infrared light)

Table 19.2: Measurement field data: Operating range limit and measurement field length of the CML 730i

Beam spacing [mm]	Typ. op. range limit ^{a)} [m]		Measurement field length ^{b)} [mm]	
	min.	max.	min.	max.
5	0.1	5.0	160	2960
10	0.2	10.5	160	2880
20	0.2	10.5	150	2870
40	0.2	10.5	290	2850

a) Typ. operating range limit: min./max. attainable range without function reserve for parallel-beam scanning.

b) Measurement field lengths and beam spacings specified in fixed rasters, see ordering table.

Table 19.3: CML 730i Operating ranges

Beam spacing [mm]	Operating range [m] Parallel-beam		Operating range [m] Diagonal-beam		Operating range [m] Crossed-beam	
	min.	max.	min.	max.	min.	max.
5	0.1	4.0	0.2	3.0	0.2	2.5
10	0.3	8.0	0.3	6.1	0.3	5.0
20	0.3	8.0	0.3	6.1	0.3	5.0
40	0.3	8.0	0.3	6.1	0.6	5.0

NOTICE

Reduction in operating range if sensitivity is set "for the detection of transparent media"!

↳ If the sensitivity is set for the detection of transparent media, the operating range is reduced to 0.3 ... 3.5 m (with beam spacing 10 mm, parallel-beam operation)

Table 19.4: CML 730i profile and measurement field lengths

Measurement field length B [mm] with beam spacing A 5 mm	Measurement field length B [mm] with beam spacing A 10 mm	Measurement field length B [mm] with beam spacing A 20 mm	Measurement field length B [mm] with beam spacing A 40 mm	Profile length L [mm]
160	160	150	-	168
240	-	-	-	248
320	320	310	290	328

Measurement field length B [mm] with beam spacing A 5 mm	Measurement field length B [mm] with beam spacing A 10 mm	Measurement field length B [mm] with beam spacing A 20 mm	Measurement field length B [mm] with beam spacing A 40 mm	Profile length L [mm]
400	-	-	-	408
480	480	470	-	488
560	-	-	-	568
640	640	630	610	648
720	-	-	-	728
800	800	790		808
880	-	-	-	888
960	960	950	930	968
1040	-	-	-	1048
1120	1120	1110	-	1128
1200	-	-	-	1208
1280	1280	1270	1250	1288
1360	-	-	-	1368
1440	1440	1430	-	1448
1520	-	-	-	1528
1600	1600	1590	1570	1608
1680	-	-	-	1688
1760	1760	1750	-	1768
1840	-	-	-	1848
1920	1920	1910	1890	1928
2000	-	-	-	2008
2080	2080	2070	-	2088
2160	-	-	-	2168
2240	2240	2230	2210	2248
2320	-	-	-	2328
2400	2400	2390	-	2408
2480	-	-	-	2488
2560	2560	2550	2530	2568
2640	-	-	-	2648
2720	2720	2710	-	2728

Measurement field length B [mm] with beam spacing A 5 mm	Measurement field length B [mm] with beam spacing A 10 mm	Measurement field length B [mm] with beam spacing A 20 mm	Measurement field length B [mm] with beam spacing A 40 mm	Profile length L [mm]
2800	-	-	-	2808
2880	2880	2870	2850	2888
2960	-	-	-	2968

Table 19.5: Data on the time behavior of the CML 730i

Response time per beam ^{a)}	10 μ s
Readiness delay	\leq 450 ms

a) cycle time = number of beams x 0.01 ms + 0.15 ms. The minimum cycle time is 1 ms.

Table 19.6: Electrical data

Operating voltage U_B	18 ... 30 VDC (incl. residual ripple)
Residual ripple	\leq 15 % within the limits of U_B
Open-circuit current	see table 19.7

Table 19.7: CML 730i open-circuit current

Measurement field length [mm]	Current consumption [mA] (without load at switching output)		
	at U_B 24 VDC	at U_B 18 VDC	at U_B 30 VDC
160	135	165	125
320	165	200	145
640	215	275	190
960	270	345	235
1440	350	455	300
1920	435	650	365
2880	600	780	500

Table 19.8: Interface data

Inputs/outputs	2 or 4 pins can be configured as input or output
Switching output current	Max. 100 mA
Signal voltage active/not active	\geq 8 V / \leq 2 V
Activation delay	\leq 1 ms

Input resistance	Approx. 6 k Ω
Analog interfaces	0 ... 10(11) V and 0(4) ... 20(24) mA
Digital interfaces	IO-Link (230.4 kbit/s; 38.4 kbit/s) CANopen (max. 1 Mbit/s) Profibus (max. 3 Mbit/s) RS 485 Modbus (921 kbit/s)

Table 19.9: Mechanical data

Housing	Continuous-cast aluminum
Lens cover	PMMA plastic
Connection technology	M12 connectors (8-pin / 5-pin)

Table 19.10: Environmental data

Temperature range (operation)	-30 °C ... +60 °C Dry cold, non-condensing; Detection of transparent media to -20 °C
Ambient temperature (storage)	-30 °C ... +70 °C
Protective circuit	Transient protection; polarity reversal protection; short circuit protection for all outputs (provide external protective circuit for inductive load for this purpose!)

Table 19.11: Certifications

Degree of protection	IP 65
Safety class	III
Certifications	UL 508, CSA C22.2 No.14 light source: exempt group (in acc. with EN 62471)
Standards applied	IEC 60947-5-2

19.2 Timing

In principle, the individual beams are always processed sequentially for light curtains. The internal controller starts transmitter 1 and then activates only the corresponding receiver 1 to measure the received light power. If the measured value exceeds the switch-on threshold, this first beam is evaluated as an uninterrupted/free beam.

The time between activation of the transmitter and evaluation in the receiver is referred to as the response time per beam.

In the CML 730i the response time per beam is = 10 µs.

The total cycle time for the evaluation of all beams and transmission to the interface is calculated as follows:

Cycle time = number of beams x response time per beam + constant

Example: cycle time = 192 beams x 0.01 ms + 0.20 ms = 2.22 ms



The minimum cycle time is 1 ms, i.e., the cycle time is never less than 1 ms, even with very short light curtains with a small number of beams.

Table 19.12: Profile and measurement field lengths, cycle times for CML 730i

Measurement field length B [mm]		Measurement field length B [mm]		Measurement field length B [mm]		Measurement field length B [mm]		Profile length L [mm]
with beam spacing A 5 [mm]	Cycle time [ms]	with beam spacing A 10 [mm]	Cycle time [ms]	with beam spacing A 20 [mm]	Cycle time [ms]	with beam spacing A 40 [mm]	Cycle time [ms]	
160	1.00	160	1.00	150	1.00	-	-	168
240	1.00	-	-	-	-	-	-	248
320	1.00	320	1.00	310	1.00	290	1.00	328
400	1.00	-	-	-	-	-	-	408
480	1.16	480	1.00	470	1.00	-	-	488
560	1.36	-	-	-	-	-	-	568
640	1.48	640	1.00	630	1.00	610	1.00	648
720	1.68	-	-	-	-	-	-	728
800	1.80	800	1.00	790	??			808
880	1.96	-	-	-	-	-	-	888
960	2.12	960	1.16	950	1.00	930	1.00	968
1040	2.28	-	-	-	-	-	-	1048
1120	2.40	1120	1.32	1110	1.00	-	-	1128
1200	2.60	-	-	-	-	-	-	1208
1280	2.76	1280	1.48	1270	1.00	1250	1.00	1288
1360	3.92	-	-	-	-	-	-	1368
1440	3.08	1440	1.64	1430	1.00	-	-	1448
1520	3.24	-	-	-	-	-	-	1528
1600	3.40	1600	1.80	1590	1.00	1570	1.00	1608
1680	3.56	-	-	-	-	-	-	1688
1760	3.62	1760	1.96	1750	1.08	-	-	1768
1840	4.88	-	-	-	-	-	-	1848
1920	4.04	1920	2.12	1910	1.16	1890	1.00	1928
2000	4.20	-	-	-	-	-	-	2008
2080	4.36	2080	2.28	2070	1.24	-	-	2088
2160	4.52	-	-	-	-	-	-	2168
2240	4.68	2240	2.44	2230	1.32	2210	1.00	2248
2320	4.84	-	-	-	-	-	-	2328
2400	5.00	2400	2.60	2390	1.40	-	-	2408
2480	5.16	-	-	-	-	-	-	2488
2560	5.32	2560	2.76	2550	1.48	2530	1.00	2568
2640	5.48	-	-	-	-	-	-	2648
2720	5.64	2720	2.92	2710	1.56	-	-	2728
2800	5.80	-	-	-	-	-	-	2808
2880	5.96	2880	3.18	2870	1.64	2850	1.00	2888
2960	6.12	-	-	-	-	-	-	2968

Limits for detecting objects

The detection of objects and the evaluation of the data depend on the following factors:

- Beam resolution and cycle time of the light curtain
- Movement speed of the objects
- Transmission rate of the data bytes
- Cycle time of the PLC

Minimum object diameter for detection perpendicular to beam plane

For a moving object, the cycle time of the light curtain must be shorter than the period of time that the object to be detected is located in the beam plane.

For an object that moves vertically to the beam plane, the following apply:

$$v_{max} = (L - 10mm) / (t_z)$$

- v_{max} [m/s] = Maximum object speed
- L [m] = Length of the object in the direction of movement
- t_z [s] = Cycle time of the light curtain

or

$$L_{min} = v \cdot t_z + 10mm$$

- L_{min} [m] = Length of the object in the direction of movement (minimum length)
- v [m/s] = Speed of the object
- t_z [s] = Cycle time of the light curtain

NOTICE

Minimum length of the gap between two successive objects!

↪ The gap between two successive objects must be greater than the minimum object diameter.

19.3 Minimum object diameter for stationary objects

The minimum object diameter of a stationary object is determined by the beam spacing and optic diameter.

Minimum object diameter for “parallel”-beam mode:

Because objects also need to be reliably detected in the transition area between two beams, the minimum object diameter is:

Beam spacing	Minimum object diameter	
5 mm	Beam spacing + 5 mm	= 10 mm
10 mm / 20 mm / 40 mm	Beam spacing + 10 mm	= 20 mm / 30 mm / 50 mm

NOTICE

Minimum object diameter for “crossed beam” mode!

↪ In “crossed beam” mode, the object diameter in the center area is reduced to 1/2 x beam spacing.

19.5 Dimensional drawings: Accessories

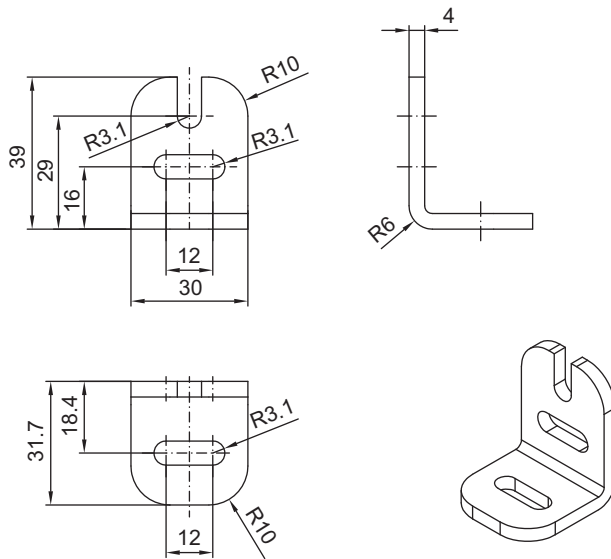

Figure 19.2: BT-2L mounting bracket

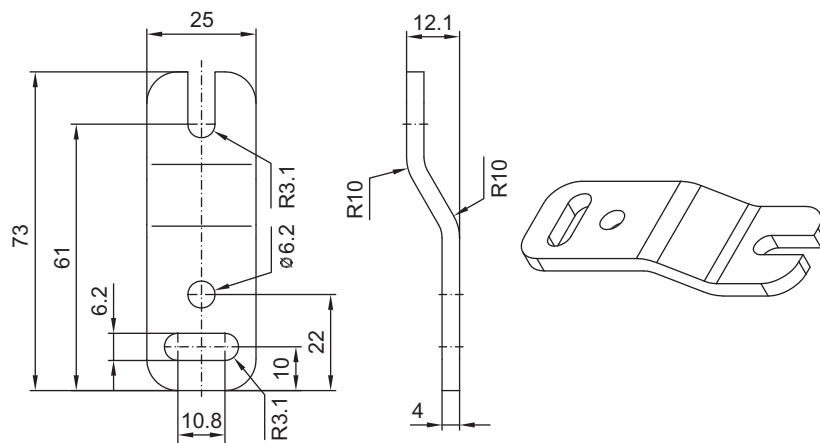

Figure 19.3: BT-2Z parallel bracket

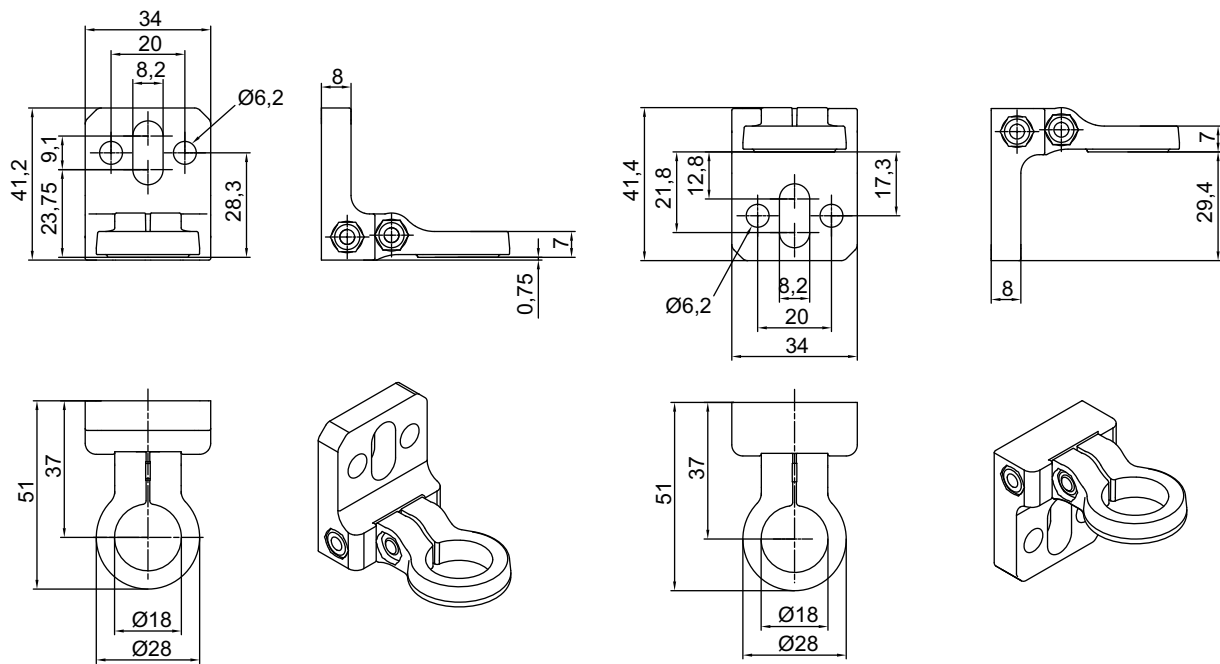

Figure 19.4: BT-2R1 swivel mount (shown in two mounting views)

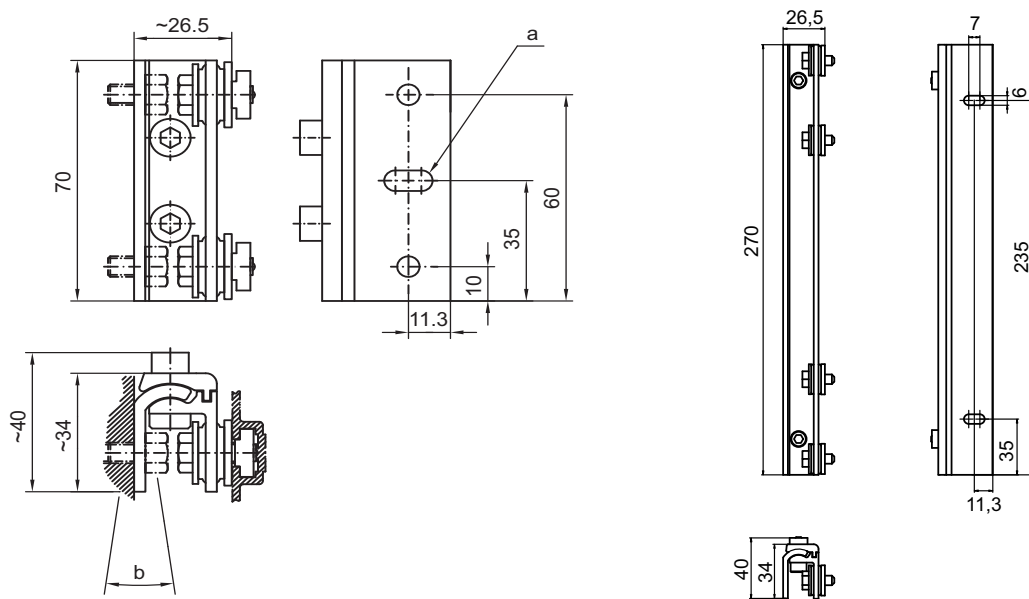

Figure 19.5: BT-2SSD and BT-2SSD-270 swiveling mounting brackets

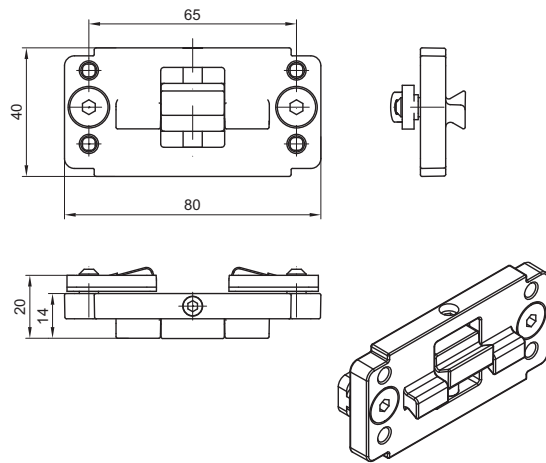

Figure 19.6: BT-2P40 clamp bracket

20 Ordering information and accessories

20.1 Nomenclature

Part designation:

CMLbbbi- fss-xxxx.a/ii-eee-ooo

Table 20.1: Part number code

CML	Operating principle: measuring light curtain
bbbi	Series: 720i for CML 720i Series: 730i for CML 730i**
f	Function classes: T: Transmitter R: Receiver
ss	Beam spacing: 05: 5 mm 10: 10 mm 20: 20 mm 40: 40 mm
xxxx	Measurement field length [mm], dependent on beam spacing: For values see tables
a	Equipment: A: axial connector outlet R: rear connector outlet
ii	Interface: L: IO-Link CN: CANopen PB: Profibus CV: Analog current and voltage output D3: RS 485 Modbus
eee	Electrical connection: M12: M12 connector
ooo	Option: EX: Explosion protection
**: Not available in the design with explosion protection.	

Table 20.2: Part descriptions, examples

Part designation	Features
CML720i-T10-1580.A/ CN-M12-EX	CML 720i, transmitter, beam spacing 10 mm, measurement field length 1580 mm, axial connector outlet, CANopen interface, M12 connector, explosion protection (zones 2 + 22)
CML720i-T05-1920.A/ CN-M12	CML 720i, transmitter, beam spacing 5 mm, measurement field length 1920 mm, axial connector outlet, CANopen interface, M12 connector
CML720i-T05-1920.A/ D3-M12	CML 720i, transmitter, beam spacing 5 mm, measurement field length 1920 mm, axial connector outlet, RS 485 Modbus interface, M12 connector

Part designation	Features
CML730i-T20-2720.A-M12	CML 730i, transmitter, beam spacing 20 mm, measurement field length 2720 mm, axial connector outlet, M12 connector
CML730i-R20-2720.R/PB-M12	CML 730i, receiver, beam spacing 20 mm, measurement field length 2720 mm, rear connector outlet, Profibus interface, M12 connector
CML730i-R20-2720.R/D3-M12	CML 730i, transmitter, beam spacing 20 mm, measurement field length 2720 mm, rear connector outlet, RS 485 Modbus interface, M12 connector

20.2 Accessories – CML 700i with IO-Link/analog interface

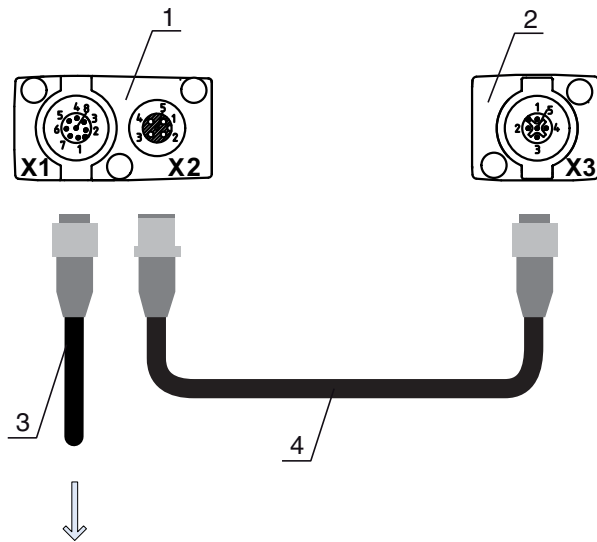

PWR IN/OUT

- 1 Receiver (R)
- 2 Transmitter (T)
- 3 Connection cable (M12 socket, 8-pin)
- 4 Synchronization cable (M12 plug/socket, 5-pin)

Figure 20.1: Electrical connection – CML 700i with IO-Link/analog interface

20.2.1 IO-Link analog interface (connection in the switch cabinet: screw terminals)

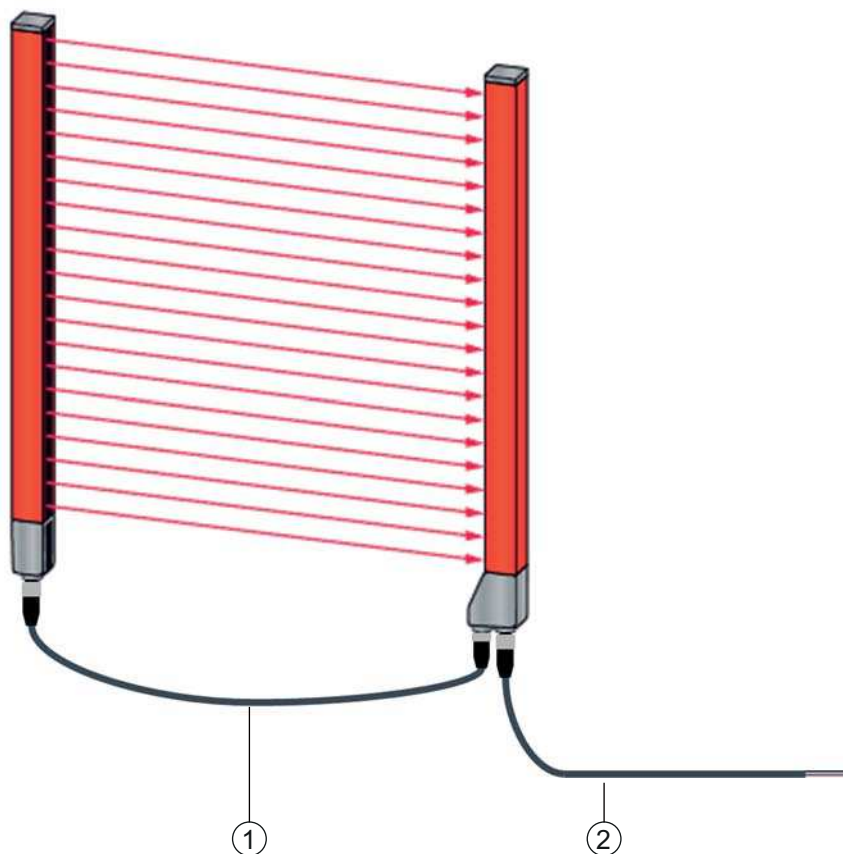

- 1 X2/X3 interconnection cable (transmitter – receiver synchronization), see table 20.4
- 2 X1 connection cable (IO-Link/analog signal, digital IO, power for connection to control in switch cabinet), see table 20.3

Figure 20.2: IO-Link interface (analog)

Table 20.3: X1 cable accessories – CML 700i with IO-Link/analog interface

Part no.	Part designation	Description
X1 connection cables for CML 700i (IO-Link/analog signal, digital IO, power for connection to control in switch cabinet); see figure 20.2		
50104591	K-D M12A-8P-2m-PUR	Connection cable, M12 socket, axial, 8-pin, length 2,000 mm, shielded PUR cable, open cable end
50104590	K-D M12A-8P-5m-PUR	Connection cable, M12 socket, 8-pin, length 5,000 mm, shielded PUR cable, open cable end
50106882	K-D M12A-8P-10m-PUR	Connection cable, M12 socket, 8-pin, length 10,000 mm, shielded PUR cable, open cable end
429178	CB-M12-8GF	M12 socket, axial, 8-pin, user configurable

X1 cable (IO-Link/analog): core colors

- Pin1 = white
- Pin2 = brown
- Pin3 = green
- Pin4 = yellow
- Pin5 = gray
- Pin6 = pink
- Pin7 = blue
- Pin8 = red



The specified core colors apply only if the cables from Leuze electronic are used.

Table 20.4: X2/X3 cable accessories – CML 700i with IO-Link/analog interface

Part no.	Part designation	Description
X2/X3 interconnection cables for CML 700i (transmitter – receiver synchronization); see figure 20.2		
50129779	KDS DN-M12-5A-M12-5A-P3-010	Interconnection cable, M12 plug/socket, axial, 5-pin, A-coded, length 1,000 mm, shielded, PUR
50129780	KDS DN-M12-5A-M12-5A-P3-020	Interconnection cable, M12 plug/socket, axial, 5-pin, A-coded, length 2,000 mm, shielded, PUR
50129781	KDS DN-M12-5A-M12-5A-P3-050	Interconnection cable, M12 plug/socket, axial, 5-pin, A-coded, length 5,000 mm, shielded, PUR
50129782	KDS DN-M12-5A-M12-5A-P3-100	Interconnection cable, M12 plug/socket, axial, 5-pin, A-coded, length 10,000 mm, shielded, PUR
50129783	KDS DN-M12-5A-M12-5A-P3-200	Interconnection cable, M12 plug/socket, axial, 5-pin, A-coded, length 20,000 mm, shielded, PUR

20.2.2 IO-Link interface (connection to IO-Link master)

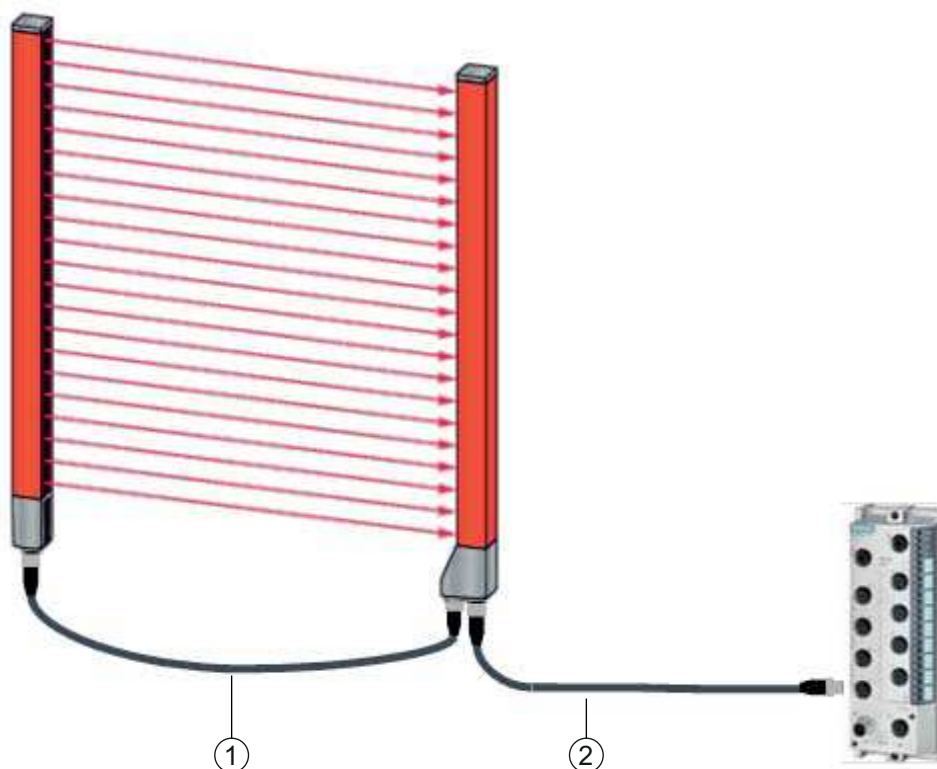

- 1 X2/X3 interconnection cables (transmitter – receiver synchronization), see table 20.6
- 2 X1 connection cable (IO-Link, power to IO-Link master with M12 connections), see table 20.5

Figure 20.3: IO-Link interface (connection to IO-Link master)

Table 20.5: X1 cable accessories – CML 700i with IO-Link interface

Part no.	Part designation	Description
X1 interconnection cables for CML 700i (IO-Link, power to IO-Link master with M12 connections); see figure 20.3		
50120999	K-DS M12A-8P-4P-2m-L-PUR	Interconnection cable: M12 socket, 8-pin, A-coded; shielded PUR cable, length 2,000 mm; M12 plug, 4-pin, A-coded
50121000	K-DS M12A-8P-4P-5m-L-PUR	Interconnection cable: M12 socket, 8-pin, A-coded; shielded PUR cable, length 5,000 mm; M12 plug, 4-pin, A-coded

Table 20.6: X2/X3 cable accessories – CML 700i with IO-Link interface

Part no.	Part designation	Description
X2/X3 interconnection cables for CML 700i (transmitter – receiver synchronization); see figure 20.3		
50129779	KDS DN-M12-5A-M12-5A-P3-010	Interconnection cable, M12 plug/socket, axial, 5-pin, A-coded, length 1,000 mm, shielded, PUR
50129780	KDS DN-M12-5A-M12-5A-P3-020	Interconnection cable, M12 plug/socket, axial, 5-pin, A-coded, length 2,000 mm, shielded, PUR

Part no.	Part designation	Description
50129781	KDS DN-M12-5A-M12-5A-P3-050	Interconnection cable, M12 plug/socket, axial, 5-pin, A-coded, length 5,000 mm, shielded, PUR
50129782	KDS DN-M12-5A-M12-5A-P3-100	Interconnection cable, M12 plug/socket, axial, 5-pin, A-coded, length 10,000 mm, shielded, PUR
50129783	KDS DN-M12-5A-M12-5A-P3-200	Interconnection cable, M12 plug/socket, axial, 5-pin, A-coded, length 20,000 mm, shielded, PUR

20.3 Accessories – CML 700i with CANopen, Profibus or RS 485 Modbus interface

20.3.1 CANopen interface

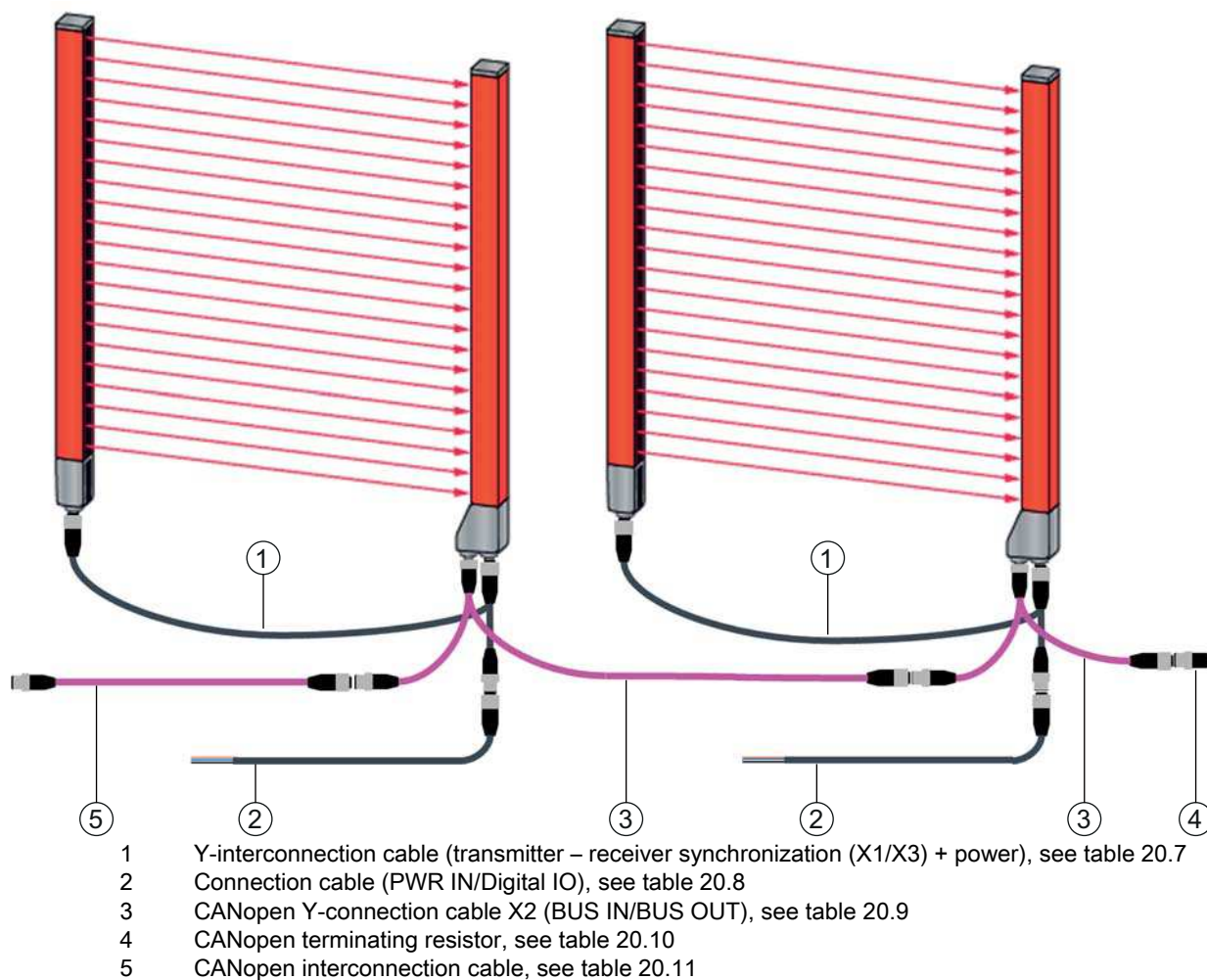

Figure 20.4: CANopen interface

Table 20.7: X1/X3 cable accessories – CML 700i with CANopen interface

Part no.	Part designation	Description
X1/X3 Y-connection and interconnection cables for CML 700i (transmitter – receiver synchronization (X1/X3) + power); see figure 20.4		
50118182	K-Y1 M12A-2m-M12A-S-PUR	Y-connection cable: duo-socket M12 (receiver X3), 8-pin, A-coded; shielded PUR cable, length 150 mm, M12 plug, 5-pin (power); shielded PUR cable, length 2,000 mm, M12 socket, 5-pin (transmitter)
50118183	K-Y1 M12A-5m-M12A-S-PUR	Y-connection cable: duo-socket M12 (receiver X3), 8-pin, A-coded; shielded PUR cable, length 150 mm, M12 plug, 5-pin (power); shielded PUR cable, length 5,000 mm, M12 socket, 5-pin (transmitter)
50122336	K-Y1 M12A-10m-M12A-S-PUR	Y-connection cable: duo-socket M12 (receiver X3), 8-pin, A-coded; shielded PUR cable, length 150 mm, M12 plug, 5-pin (power); shielded PUR cable, length 10,000 mm, M12 socket, 5-pin (transmitter)
50122337	K-Y1 M12A-20m-M12A-S-PUR	Y-connection cable: duo-socket M12 (receiver X3), 8-pin, A-coded; shielded PUR cable, length 150 mm, M12 plug, 5-pin (power); shielded PUR cable, length 20,000 mm, M12 socket, 5-pin (transmitter)

Table 20.8: PWR IN/digital IO cable accessories – CML 700i with CANopen interface

Part no.	Part designation	Description
X1 short open end of the Y-connection cable for CML 700i (PWR IN/digital IO); see figure 20.4		
50104555	K-D M12A-5P-2m-PVC	Connection cable: M12 socket, 5-pin, A-coded; PVC cable, length 2,000 mm, open cable end
50104557	K-D M12A-5P-5m-PVC	Connection cable: M12 socket, 5-pin, A-coded; PVC cable, length 5,000 mm, open cable end
50104559	K-D M12A-5P-10m-PVC	Connection cable: M12 socket, 5-pin, A-coded; PVC cable, length 10,000 mm, open cable end
50104567	K-D M12A-5P-2m-PUR	Connection cable: M12 socket, 5-pin, A-coded; PUR cable, length 2,000 mm, open cable end
50104569	K-D M12A-5P-5m-PUR	Connection cable: M12 socket, 5-pin, A-coded; PUR cable, length 5,000 mm, open cable end

PWR IN/digital IO cable accessories: core colors

- Pin1 = brown
- Pin2 = white
- Pin3 = blue
- Pin4 = black
- Pin5 = gray



The specified core colors apply only if the cables from Leuze electronic are used.

Table 20.9: X2 cable accessories – CML 700i with CANopen interface

Part no.	Part designation	Description
X2 Y-interconnection cables CANopen for CML 700i (BUS IN, BUS OUT); see figure 20.4		
50118185	K-YCN M12A-M12A-S-PUR	Y-connection cable CANopen: duo-socket M12, 5-pin, A-coded (receiver X2); shielded PUR cable, length 250 mm to M12 plug, 5-pin (BUS IN); shielded PUR cable, length 350 mm, M12 socket, 5-pin (BUS OUT)
50118184	K-YCN M12A-5m-M12A-S-PUR	Y-connection cable CANopen: duo-socket M12, 5-pin, A-coded (receiver X2); shielded PUR cable, length 250 mm to M12 plug, 5-pin (BUS IN); shielded PUR cable, length 5,000 mm, M12 socket, 5-pin (BUS OUT)

Table 20.10: Termination/bus termination accessories – CML 700i with CANopen interface

Art. no.	Part designation	Description
Termination/bus termination for CML 700i (terminating resistor);see figure 20.4		
50040099	TS 01-5-SA	Terminating connector for CANopen interface (BUS OUT), with integrated terminating resistor

Table 20.11: Cable accessories – CML 700i with CANopen interface

Part no.	Part designation	Description
Y-interconnection cables CANopen for CML 700i;see figure 20.4		
50129779	KDS DN-M12-5A-M12-5A-P3-010	Interconnection cable, M12 plug/socket, axial, 5-pin, A-coded, length 1,000 mm, shielded, PUR
50129780	KDS DN-M12-5A-M12-5A-P3-020	Interconnection cable, M12 plug/socket, axial, 5-pin, A-coded, length 2,000 mm, shielded, PUR
50129781	KDS DN-M12-5A-M12-5A-P3-050	Interconnection cable, M12 plug/socket, axial, 5-pin, A-coded, length 5,000 mm, shielded, PUR
50129782	KDS DN-M12-5A-M12-5A-P3-100	Interconnection cable, M12 plug/socket, axial, 5-pin, A-coded, length 10,000 mm, shielded, PUR
50129783	KDS DN-M12-5A-M12-5A-P3-200	Interconnection cable, M12 plug/socket, axial, 5-pin, A-coded, length 20,000 mm, shielded, PUR

20.3.2 Profibus or RS 485 Modbus interface

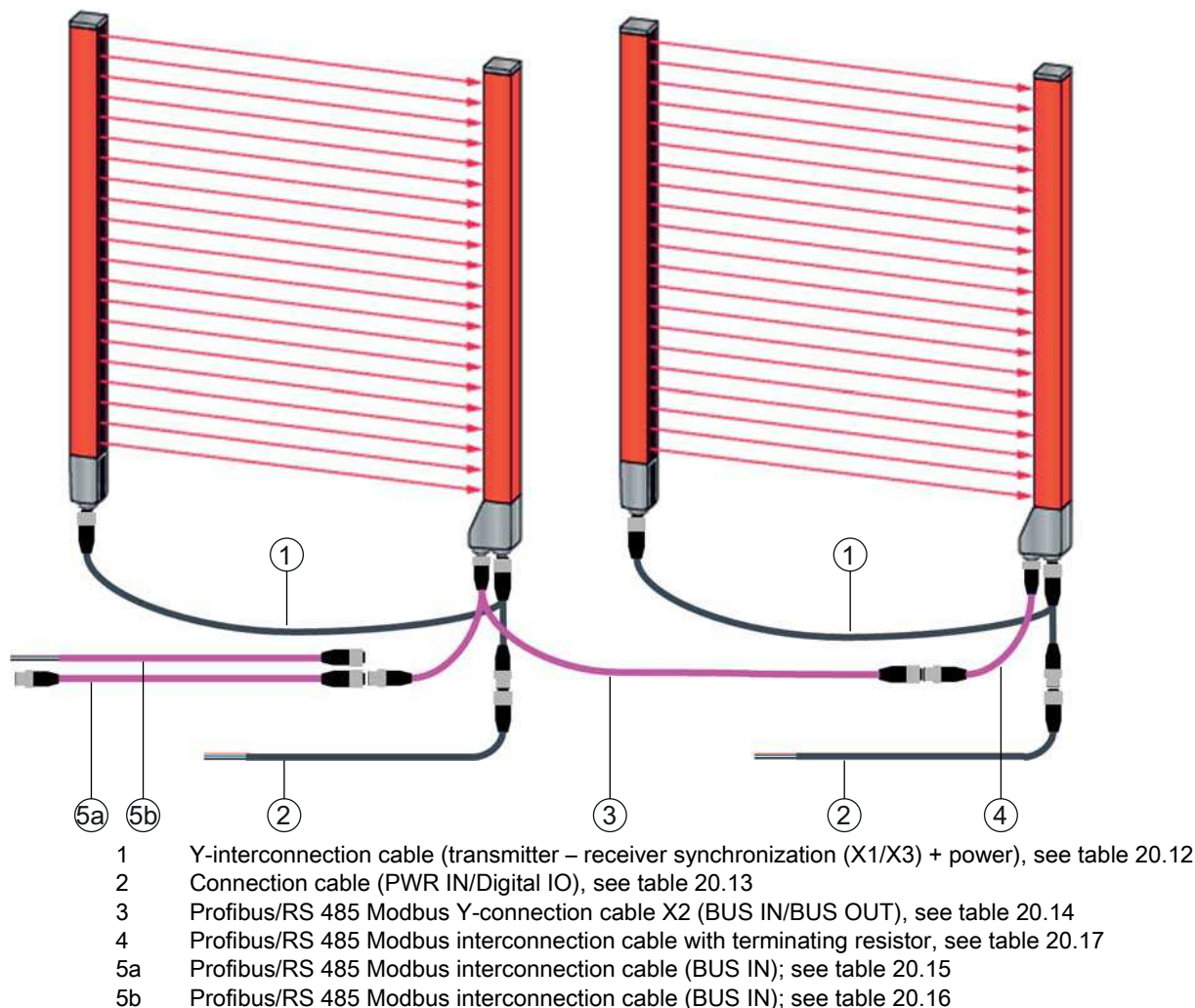

Figure 20.5: Profibus or RS 485 Modbus interface

Table 20.12: X1/X3 cable accessories – CML 700i with Profibus or RS 485 Modbus interface

Part no.	Part designation	Description
X1/X3 Y-connection and interconnection cables for CML 700i (transmitter – receiver synchronization (X1/X3) + power); see figure 20.5		
50118182	K-Y1 M12A-2m-M12A-S-PUR	Y-connection cable: duo-socket M12 (receiver X3), 8-pin, A-coded; shielded PUR cable, length 150 mm, M12 plug, 5-pin (power); shielded PUR cable, length 2,000 mm, M12 socket, 5-pin (transmitter)

Part no.	Part designation	Description
50118183	K-Y1 M12A-5m-M12A-S-PUR	Y-connection cable: duo-socket M12 (receiver X3), 8-pin, A-coded; shielded PUR cable, length 150 mm, M12 plug, 5-pin (power); shielded PUR cable, length 5,000 mm, M12 socket, 5-pin (transmitter)
50122336	K-Y1 M12A-10m-M12A-S-PUR	Y-connection cable: duo-socket M12 (receiver X3), 8-pin, A-coded; shielded PUR cable, length 150 mm, M12 plug, 5-pin (power); shielded PUR cable, length 10,000 mm, M12 socket, 5-pin (transmitter)
50122337	K-Y1 M12A-20m-M12A-S-PUR	Y-connection cable: duo-socket M12 (receiver X3), 8-pin, A-coded; shielded PUR cable, length 150 mm, M12 plug, 5-pin (power); shielded PUR cable, length 20,000 mm, M12 socket, 5-pin (transmitter)

Table 20.13: PWR IN/digital IO cable accessories – CML 700i with Profibus or RS 485 Modbus interface

Part no.	Part designation	Description
X1 short open end of the Y-connection cable for CML 700i (PWR IN/digital IO); see figure 20.5		
50104555	K-D M12A-5P-2m-PVC	Connection cable: M12 socket, 5-pin, A-coded; PVC cable, length 2,000 mm, open cable end
50104557	K-D M12A-5P-5m-PVC	Connection cable: M12 socket, 5-pin, A-coded; PVC cable, length 5,000 mm, open cable end
50104559	K-D M12A-5P-10m-PVC	Connection cable: M12 socket, 5-pin, A-coded; PVC cable, length 10,000 mm, open cable end
50104567	K-D M12A-5P-2m-PUR	Connection cable: M12 socket, 5-pin, A-coded; PUR cable, length 2,000 mm, open cable end
50104569	K-D M12A-5P-5m-PUR	Connection cable: M12 socket, 5-pin, A-coded; PUR cable, length 5,000 mm, open cable end

PWR IN/digital IO cable accessories: core colors

- Pin1 = brown
- Pin2 = white
- Pin3 = blue
- Pin4 = black
- Pin5 = gray



The specified core colors apply only if the cables from Leuze electronic are used.

Table 20.14: X2 cable accessories – CML 700i with Profibus or RS 485 Modbus interface

Part no.	Part designation	Description
X2 Y-connection cables Profibus/RS 485 Modbus for CML 700i (X2, BUS IN, BUS OUT, potential-free), see figure 20.5		
50123263	K-YPB M12A-M12A-S-PUR	Profibus Y-connection cable: duo-plug M12 axial, 5-pin (2 wires), B-coded (receiver X2); shielded PUR cable, length 250 mm to M12 plug, 5-pin (2 wires; BUS IN); shielded PUR cable, length 350 mm to M12 socket, 5-pin (2 wires; BUS OUT)
50123265	K-YPB M12A-5m-M12A-S-PUR	Profibus Y-connection cable: duo-plug M12 axial, 5-pin (2 wires), B-coded (receiver X2); shielded PUR cable, length 250 mm to M12 plug, 5-pin (2 wires; BUS IN); shielded PUR cable, length 5,000 mm to M12 socket, 5-pin (2 wires; BUS OUT)

Table 20.15: Cable accessories – CML 700i with Profibus or RS 485 Modbus interface

Part no.	Part designation	Description
Interconnection cables for CML 700i (BUS IN); see figure 20.5		
50104096	KB PB-1000-SBA	Interconnection cable, M12 plug, 4-pin, B-coded; shielded PUR cable, length 1,000 mm; M12 socket, axial, 4-pin, B-coded
50104097	KB PB-2000-SBA	Interconnection cable, M12 plug, 4-pin, B-coded; shielded PUR cable, length 2,000 mm; M12 socket, axial, 4-pin, B-coded
50104098	KB PB-5000-SBA	Interconnection cable, M12 plug, 4-pin, B-coded; shielded PUR cable, length 5,000 mm; M12 socket, axial, 4-pin, B-coded
50104099	KB PB-10000-SBA	Interconnection cable, M12 plug, 4-pin, B-coded; shielded PUR cable, length 10,000 mm; M12 socket, axial, 4-pin, B-coded

Table 20.16: Cable accessories – CML 700i with Profibus or RS 485 Modbus interface

Part no.	Part designation	Description
Connection cables for CML 700i (BUS IN); see figure 20.5		
50104181	KB PB-2000-BA	Connection cable: M12 socket, 5-pin (2 wires), B-coded; shielded PUR cable, length 2,000 mm; open cable end
50104180	KB PB-5000-BA	Connection cable: M12 socket, 5-pin (2 wires), B-coded; shielded PUR cable, length 5,000 mm; open cable end
50104179	KB PB-10000-BA	Connection cable: M12 socket, 5-pin (2 wires), B-coded; shielded PUR cable, length 10,000 mm; open cable end
50104178	KB PB-15000-BA	Connection cable: M12 socket, 5-pin (2 wires), B-coded; shielded PUR cable, length 15,000 mm; open cable end

Table 20.17: Interconnection cable/terminating resistor accessories – CML 700i with Profibus or RS 485 Modbus-interface

Part no.	Part designation	Description
Interconnection cable with terminating resistor for CML 700i (X2 (Bus IN), potential-free), see figure 20.5		
50124297	K-SSPB M12A-M12A-2P-0.3m-S-PUR	Profibus connection cable: M12 plug, 5-pin (2 wires), B-coded (BUS IN); shielded PUR cable, length 300 mm; M12 plug, 4-pin, B-coded with integrated terminating resistor for Profibus / RS 485 Modbus (receiver X2)

Table 20.18: Cable socket accessories – CML 700i with Profibus or RS 485 Modbus interface

Part no.	Part designation	Description
Cable socket for CML 700i (for configuring connection cables with ground reference)		
50038538	KD 02-5-BA	Cable socket: M12 socket, 5-pin, B-coded; user configurable

20.3.3 Profibus/RS 485 Modbus interface (alternative terminating resistor)

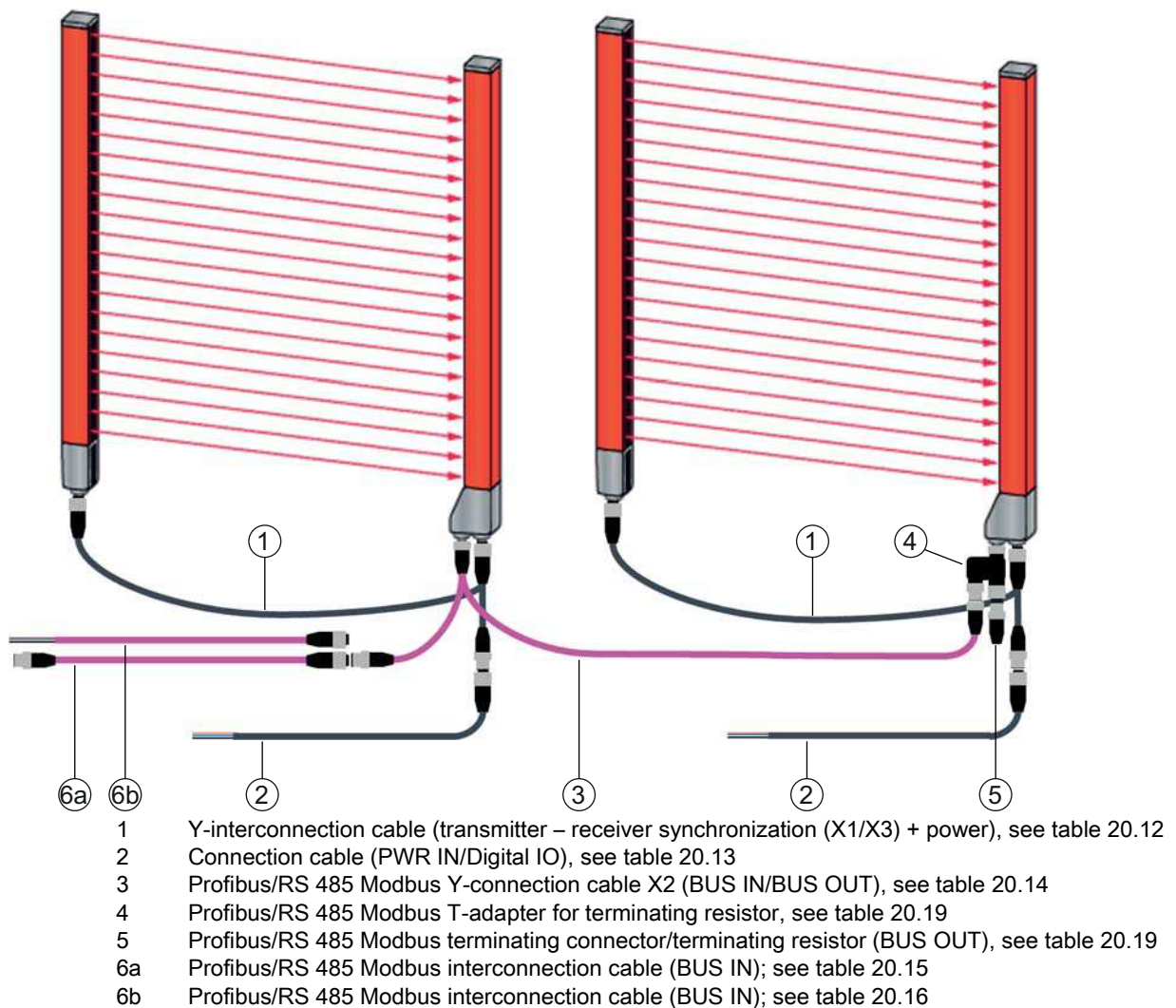

Figure 20.6: Profibus or RS 485 Modbus interface (alternative terminating resistor)

Table 20.19: Terminating resistor accessories – CML 700i with Profibus or RS 485 Modbus interface

Part no.	Part designation	Description
T-adapter for CML 700i (X2 (BUS IN, BUS OUT)); see figure 20.6		
50109834	KDS BUS OUT M12-T-5P	T-adapter Profibus: M12 plug, 5-pin, B-coded (receiver X2); M12 plug, 5-pin, B-coded (BUS IN); M12 socket, 5-pin, B-coded (BUS OUT)
Terminating resistor for CML 700i (BUS OUT); see figure 20.6		
50038539	TS 02-4-SA	Terminating connector for Profibus or RS 485 Modbus interface (BUS OUT), with integrated terminating resistor

20.3.4 Profibus/RS 485 Modbus interface (configuration with subsequent slave)

Table 20.20: Cable accessories – CML 700i with Profibus or RS 485 Modbus interface

Part no.	Part designation	Description
Interconnection cables for CML 700i (BUS OUT)		
50104188	K-PB-2000-SA	Interconnection cable: M12 socket, 5-pin (2 wires), B-coded; shielded PUR cable, length 2,000 mm; open cable end
50104187	K-PB-5000-SA	Interconnection cable: M12 socket, 5-pin (2 wires), B-coded; shielded PUR cable, length 5,000 mm; open cable end

20.4 Accessories - fastening technology

Table 20.21: Fastening technology accessories

Part no.	Part designation	Description
Mounting technology		
429056	BT-2L	L mounting bracket (angled), 2 x
429057	BT-2Z	Z mounting bracket (parallel), 2 x
429046	BT-2R1	360° swivel mount, 2 x incl. 1 MLC cylinder
429058	BT-2SSD	Swiveling mounting bracket with shock absorber, ± 8°, 70 mm long, 2 x
429059	BT-4SSD	Swiveling mounting bracket with shock absorber, ± 8°, 70 mm long, 4 x
429049	BT-2SSD-270	Swiveling mounting bracket with shock absorber, ± 8°, 270 mm long, 2 x
424417	BT-2P40	Clamp bracket
425740	BT-10NC60	Sliding block with M6 thread, 10 x
425741	BT-10NC64	Sliding block with M6 and M4 thread, 10 x
425742	BT-10NC65	Sliding block with M6 and M5 thread, 10 x

20.5 Accessories – PC connection

Table 20.22: Accessories - PC connection configuration

Part no.	Part designation	Description
IO-Link USB master V2.0		
50121098	SET MD12-US2-IL1.1 + accessories	IO-Link USB master V2.0 Plug-in power supply unit (24 V/24 W) with international adapters High-speed USB 2.0 connection cable; USB A to Mini-USB Data carrier with software, drivers and documentation
Adapter cables for CML 700i (IO-Link, analog)		
50120999	K-DS M12A-8P-4P-2m L-PUR	Adapter cable: M12 socket, 8-pin, B-coded; PUR cable, length 2,000 mm; M12 plug, 5-pin, B-coded
50121000	K-DS M12A-8P-4P-5m L-PUR	Adapter cable: M12 socket, 8-pin, B-coded; PUR cable, length 5,000 mm; M12 plug, 5-pin, B-coded

20.6 Scope of delivery

- 1 transmitter incl. 2 sliding blocks (profile length from 2 m: 3 sliding blocks; profile length from 2.5 m: 4 sliding blocks)
- 1 receiver incl. 2 sliding blocks, (profile length from 2 m: 3 sliding blocks; profile length from 2.5 m: 4 sliding blocks)
- 1 set of operating instructions (PDF file on data carrier)



Connection and interconnection cables, mounting brackets, IO-Link USB master (incl. *Sensor Studio* configuration software), etc., are not included in the delivery contents but must rather be ordered separately.



Devices with rear connector outlet are also delivered with a cylinder and a screw. These extra parts are needed for mounting with the BT-2R1 swivel mount; see table 20.21.

21 EC Declaration of Conformity

The measuring light curtains of the CML series have been developed and manufactured in accordance with the applicable European standards and directives.

The manufacturer of the product, Leuze electronic GmbH + Co. KG in D-73277 Owen, possesses a certified quality assurance system in accordance with ISO 9001.



BSD-disclaimer for Modbus

Copyright (c) 2006 Christian Walter <wolti@sil.at>

All rights reserved.

Redistribution and use in source and binary forms, with or without modification, are permitted provided that the following conditions are met:

1. Redistributions of source code must retain the above copyright notice, this list of conditions and the following disclaimer.
2. Redistributions in binary form must reproduce the above copyright notice, this list of conditions, and the following disclaimer in the documentation and/or other materials provided with the distribution.
3. The name of the author may not be used to endorse or promote products derived from this software without specific prior written permission.

THIS SOFTWARE IS PROVIDED BY THE AUTHOR "AS IS" AND ANY EXPRESS OR IMPLIED WARRANTIES, INCLUDING, BUT NOT LIMITED TO, THE IMPLIED WARRANTIES OF MERCHANTABILITY AND FITNESS FOR A PARTICULAR PURPOSE ARE DISCLAIMED.

IN NO EVENT SHALL THE AUTHOR BE LIABLE FOR ANY DIRECT, INDIRECT, INCIDENTAL, SPECIAL, EXEMPLARY, OR CONSEQUENTIAL DAMAGES (INCLUDING, BUT NOT LIMITED TO, PROCUREMENT OF SUBSTITUTE GOODS OR SERVICES; LOSS OF USE, DATA, OR PROFITS; OR BUSINESS INTERRUPTION) HOWEVER CAUSED AND ON ANY THEORY OF LIABILITY, WHETHER IN CONTRACT, STRICT LIABILITY, OR TORT (INCLUDING NEGLIGENCE OR OTHERWISE) ARISING IN ANY WAY OUT OF THE USE OF THIS SOFTWARE, EVEN IF ADVISED OF THE POSSIBILITY OF SUCH DAMAGE.