

the sensor people

AMS 348*i* SSI
Optical Laser Measurement System
PROFINET / SSI

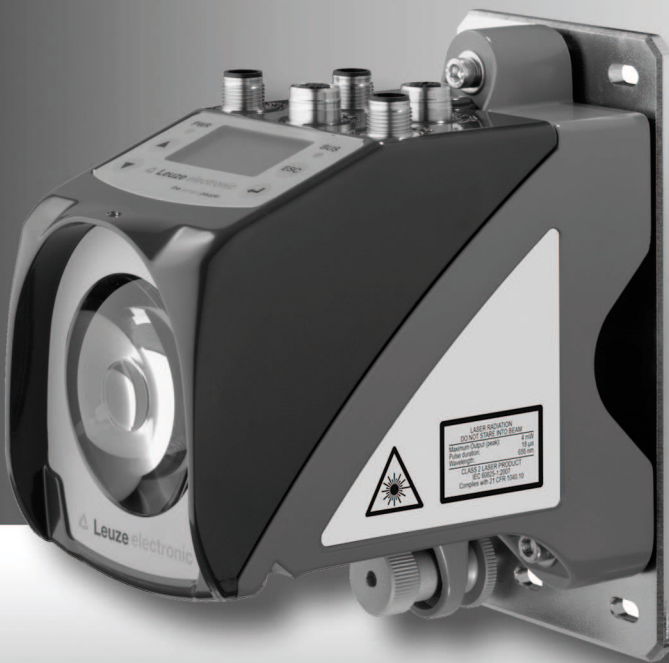

en.01-2014/11 50125898
We reserve the right to
make technical changes

© 2014

Leuze electronic GmbH + Co. KG

In der Braike 1

D-73277 Owen / Germany

Phone: +49 7021 573-0

Fax: +49 7021 573-199

<http://www.leuze.com>

info@leuze.de

The main menus

```
AMS 348i 120 SSI
Leuze electronic
    GmbH & Co. KG
SM: V 1.3.0 HW:1
SN: -----
```

Device information - main menu

This menu item contains detailed information on

- Device model,
- Manufacturer,
- Software and hardware version,
- Serial number.

No entries can be made via the display.



```
Network information
Address:  ---.---.---.---
Net mask: ---.---.---.---
Gateway: ---.---.---.---
MAC ID:  ---.---.---.---
DevName: -----
```

Network information - main menu

Under this menu item, you will find detailed information on the network addresses.

No entries can be made via the display.



```
IO1 LSR PLB LNK0
IO2 TMP ATT LNK1
ERR SSI
+ 87.000m
```

Status and measurement data - main menu

- Display of status-, warning-, and error messages.
- Status overview of the switching inputs/outputs.
- Bar graph for the reception level.
- Activated interface.
- Measurement value.

No entries can be made via the display.

See "Indicators in the display" on page 41.



```
Parameter
Parameter handlin
PROFINET
SSI
Maximum position value
I/O
```

Parameter - main menu

Configuration for PROFi NET is carried out via the modules of the GSDML file.



Device buttons:

-  Navigate upward/laterally
-  Navigate downward/laterally
-  ESCAPE leave
-  ENTER confirm

Input of values

```
100
<-10123456789 save
Standard ---- Unit
126 | |
```

```
Language selection
o Deutsch
● English
o Español
o Français
o Italiano
```

Language selection - main menu

- Selection of the display language.

See "Language selection menu" on page 52.



```
Service
Status messages
Diagnostics
Expanded diagnostics
```

Service - main menu

- Display of status messages.
- Display of diagnostic data.

No entries can be made via the display.

See "Service menu" on page 52.

 +  Delete character

... +  Enter digit

save +  Save input

1	General information	5
1.1	Explanation of symbols	5
1.2	Declaration of conformity	5
1.3	Description of functions AMS 348i SSI	6
2	Safety	7
2.1	Intended use	7
2.2	Foreseeable misuse	8
2.3	Competent persons	8
2.4	Disclaimer	9
2.5	Laser safety notices	9
3	Fast commissioning / operating principle	12
3.1	Mounting the AMS 348i SSI	12
3.1.1	Mounting the device	12
3.1.2	Reflector mounting	12
3.2	Connecting the voltage supply	13
3.3	Display	13
3.4	AMS 348i SSI on the PROFINET	13
4	Specifications	14
4.1	Specifications of the laser measurement system	14
4.1.1	General specifications AMS 348i SSI	14
4.1.2	Dimensioned drawing AMS 348i SSI	16
4.1.3	Type overview AMS 348i SSI	17
5	Installation and mounting	18
5.1	Storage, transportation	18
5.2	Mounting the AMS 348i SSI	19
5.2.1	Optional mounting bracket	21
5.2.2	Parallel mounting of the AMS 348i SSI	22
5.2.3	Parallel mounting of AMS 348i SSI and DDLS optical data transmission	23
5.3	Mounting the AMS 348i SSI with laser beam deflector unit	24
5.3.1	Mounting the laser beam deflector unit With integrated mounting bracket	24
5.3.2	Dimensioned drawing of US AMS 01 deflector unit	25
5.3.3	Mounting the US 1 OMS deflector unit without mounting bracket	26

6	Reflectors	27
6.1	General information	27
6.2	Description of the reflective tape	27
6.2.1	Specifications of the self-adhesive foil	28
6.2.2	Specifications of the reflective tape on a metal plate	28
6.2.3	Dimensioned drawing of reflective tape on a metal plate	29
6.2.4	Specifications of heated reflectors	30
6.2.5	Dimensioned drawing of heated reflectors	31
6.3	Selecting reflector sizes	32
6.4	Mounting the reflector	33
6.4.1	General information	33
6.4.2	Mounting the reflector	33
6.4.3	Table of reflector pitches	36
7	Electrical connection	37
7.1	Safety notices for the electrical connection	37
7.2	PWR – voltage supply / switching input/output	38
7.3	PROFINET BUS IN	38
7.4	PROFINET BUS OUT	39
7.5	SSI	39
7.6	Service	40
8	Display and control panel AMS 348i SSI	41
8.1	Structure of the control panel	41
8.2	Status display and operation	41
8.2.1	Indicators in the display	41
8.2.2	LED status displays	43
8.2.3	Control buttons	45
8.3	Menu description	46
8.3.1	The main menus	46
8.3.2	Parameter menu	48
8.3.3	Language selection menu	52
8.3.4	Service menu	52
8.4	Operation	53

9	PROFINET interface	55
9.1	General information on PROFINET	55
9.2	Identification & Maintenance Functions	55
9.3	PROFINET – Star topology	55
9.4	PROFINET – Linear topology	56
9.5	PROFINET – General information on wiring	56
9.6	PROFINET – Cable lengths and shielding	57
9.7	PROFINET - Electrical connection	58
9.8	PROFINET – Commissioning and configuration	59
9.8.1	PROFINET implementation of the AMS 348i	59
9.8.2	Measures to be performed prior to the initial commissioning	60
9.8.3	Starting the device	61
9.8.4	Configuration steps for a Siemens Simatic S7 control	61
9.9	PROFINET GSD file	67
9.9.1	General information on the GSD file	67
9.9.2	Overview of the GSD modules	69
9.9.3	Detail description of the modules	71
10	SSI	100
10.1	Principle functionality of the SSI interface	100
10.1.1	SSI sequence diagram	101
10.1.2	Cable length as a function of the data rate	102
10.2	SSI - Electrical connection	102
10.3	General Information to the AMS 348i SSI parameters	103
10.4	Default settings of the SSI interface	103
10.4.1	Changing the SSI settings via the display	104
11	Diagnostics and troubleshooting	105
11.1	Service and diagnostics in the display of the AMS 348i SSI	106
11.1.1	Status messages	106
11.1.2	Diagnostics	107
11.1.3	Expanded diagnostics	107
11.2	General causes of errors	108
11.2.1	Power LED	108
11.3	Interface errors	109
11.3.1	BUS LED	109
11.4	Status display in the display of the AMS 348i SSI	109

12	Type overview and accessories	111
12.1	Type key	111
12.2	Type overview AMS 348 <i>i</i> SSI (PROFINET + SSI).....	111
12.3	Overview of reflector types	112
12.4	Accessories.....	112
12.4.1	Accessory mounting bracket.....	112
12.4.2	Accessory deflector unit	112
12.4.3	Accessory M12 connector.....	112
12.4.4	Accessory ready-made cables for voltage supply.....	113
12.4.5	Accessory ready-made cables for PROFINET.....	114
12.4.6	Accessory ready-made cables for SSI	116
13	Maintenance	118
13.1	General maintenance information	118
13.2	Repairs, servicing	118
13.3	Disassembling, packing, disposing	118

1 General information

1.1 Explanation of symbols

The symbols used in this operating manual are explained below.



Attention!

This symbol precedes text messages which must strictly be observed. Failure to comply with this information results in injuries to personnel or damage to the equipment.



Attention Laser!

This symbol warns of possible danger caused by hazardous laser radiation.



Notice!

This symbol indicates text passages containing important information.

1.2 Declaration of conformity

The AMS 348*i* SSI absolute measuring optical laser measurement system was designed and manufactured in accordance with applicable European directives and standards.

The AMS series is "UL LISTED" according to American and Canadian safety standards and fulfills the requirements of Underwriter Laboratories Inc. (UL).



Notice!















The Declaration of Conformity for these devices can be requested from the manufacturer.

The manufacturer of the product, Leuze electronic GmbH + Co. KG in D-73277 Owen, possesses a certified quality assurance system in accordance with ISO 9001.

1.3 Description of functions AMS 348*i* SSI

The AMS 348*i* SSI optical laser measurement system calculates distances to fixed as well as moving system parts. The distance to be measured is calculated according to the principle of the propagation time of radiated light. Here, the light emitted by the laser diode is reflected by a reflector onto the receiving element of the laser measurement system. The AMS 348*i* SSI uses the "propagation time" of the light to calculate the distance to the reflector. The high absolute measurement accuracy of the laser measurement system and the fast integration time are designed for position control applications.

With the AMS 3xx*i* product series, Leuze electronic makes available a range of internationally relevant interfaces. Note that each interface version listed below corresponds to a different AMS 3xx*i* model.

		AMS 304<i>i</i>
		AMS 348<i>i</i>
		AMS 348<i>i</i> with SSI
		AMS 355<i>i</i>
		AMS 358<i>i</i>
		AMS 335<i>i</i>
		AMS 338<i>i</i>
		AMS 308<i>i</i>
		AMS 384<i>i</i>
		AMS 301<i>i</i>
		AMS 300<i>i</i>

2 Safety

This sensor was developed, manufactured and tested in line with the applicable safety standards. It corresponds to the state of the art.

2.1 Intended use

The AMS is an absolute measuring optical laser measurement system which allows distance measurement of up to 300m against a reflector.

Areas of application

The AMS is designed for the following areas of application:

- Positioning of automated, moving plant components
- Travel and lifting axes of high-bay storage devices
- Repositioning units
- Gantry crane bridges and their trolleys
- Lifts
- Electroplating plants



CAUTION

Observe intended use!

↪ Only operate the device in accordance with its intended use. The protection of personnel and the device cannot be guaranteed if the device is operated in a manner not complying with its intended use.

Leuze electronic GmbH + Co. KG is not liable for damages caused by improper use.

↪ Read the technical description before commissioning the device. Knowledge of this technical description is an element of proper use.

NOTICE

Comply with conditions and regulations!

↪ Observe the locally applicable legal regulations and the rules of the employer's liability insurance association.



Attention

For UL applications, use is permitted exclusively in Class 2 circuits according to NEC (National Electric Code).

2.2 Foreseeable misuse

Any use other than that defined under "Intended use" or which goes beyond that use is considered improper use.

In particular, use of the device is not permitted in the following cases:

- Rooms with explosive atmospheres
- Circuits relevant to safety
- For medicinal purposes

NOTICE

Do not modify or otherwise interfere with the device.

- ↳ Do not carry out modifications or otherwise interfere with the device. The device must not be tampered with and must not be changed in any way. The device must not be opened. There are no user-serviceable parts inside. Repairs must only be performed by Leuze electronic GmbH + Co. KG.

2.3 Competent persons

Connection, mounting, commissioning and adjustment of the device must only be carried out by competent persons.

Prerequisites for competent persons:

- They have a suitable technical education.
- They are familiar with the rules and regulations for occupational safety and safety at work.
- They are familiar with the technical description of the device.
- They have been instructed by the responsible person on the mounting and operation of the device.

Certified electricians

Electrical work must be carried out by a certified electrician.

Due to their technical training, knowledge and experience as well as their familiarity with relevant standards and regulations, certified electricians are able to perform work on electrical systems and independently detect possible dangers.

In Germany, certified electricians must fulfill the requirements of accident-prevention regulations BGV A3 (e.g. electrician foreman). In other countries, there are respective regulations that must be observed.

2.4 Disclaimer

Leuze electronic GmbH + Co. KG is not liable in the following cases:

- The device is not being used properly.
- Reasonably foreseeable misuse is not taken into account.
- Mounting and electrical connection are not properly performed.
- Changes (e.g., constructional) are made to the device.

2.5 Laser safety notices

	<p>ATTENTION LASER RADIATION – LASER CLASS 2</p>
<p>Never look directly into the beam!</p> <p>The device satisfies the requirements of IEC 60825-1:2007 (EN 60825-1:2007) safety regulations for a product in laser class 2 as well as the U.S. 21 CFR 1040.10 regulations with deviations corresponding to "Laser Notice No. 50" from June 24th, 2007.</p> <ul style="list-style-type: none"> ☞ Never look directly into the laser beam or in the direction of reflecting laser beams. If you look into the beam path over a longer time period, there is a risk of injury to the retina. ☞ Do not point the laser beam of the device at persons! ☞ Interrupt the laser beam using a non-transparent, non-reflective object if the laser beam is accidentally directed towards a person. ☞ When mounting and aligning the device, avoid reflections of the laser beam off reflective surfaces! ☞ CAUTION! The use of operating or adjusting devices other than those specified here or carrying out of differing procedures may lead to dangerous exposure to radiation. ☞ Adhere to the applicable legal and local regulations regarding protection from laser beams. ☞ The device must not be tampered with and must not be changed in any way. There are no user-serviceable parts inside the device. Repairs must only be performed by Leuze electronic GmbH + Co. KG. 	

NOTICE**Affix laser information and warning signs!**

Laser information and warning signs are attached to the device (see figure 2.1):

In addition, self-adhesive laser warning and information signs (stick-on labels) are supplied in several languages (see figure 2.2).

↪ Affix the laser information sheet to the device in the language appropriate for the place of use.

When using the device in the US, use the stick-on label with the "Complies with 21 CFR 1040.10" notice.

↪ Affix the laser information and warning signs near the device if no signs are attached to the device (e.g., because the device is too small) or if the attached laser information and warning signs are concealed due to the installation position.

Affix the laser information and warning signs so that they are legible without exposing the reader to the laser radiation of the device or other optical radiation.

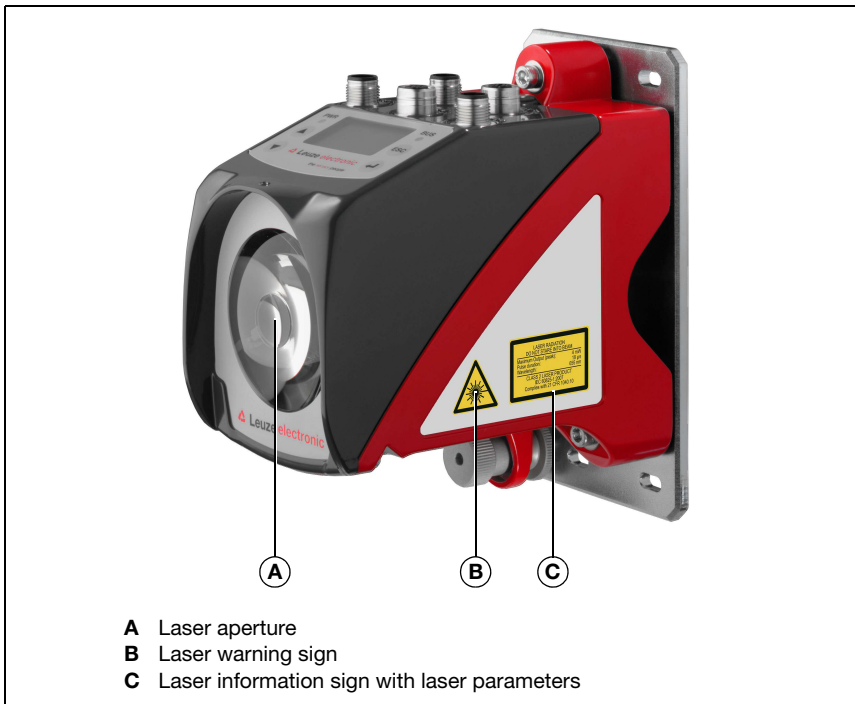

Figure 2.1: Laser apertures, laser warning signs

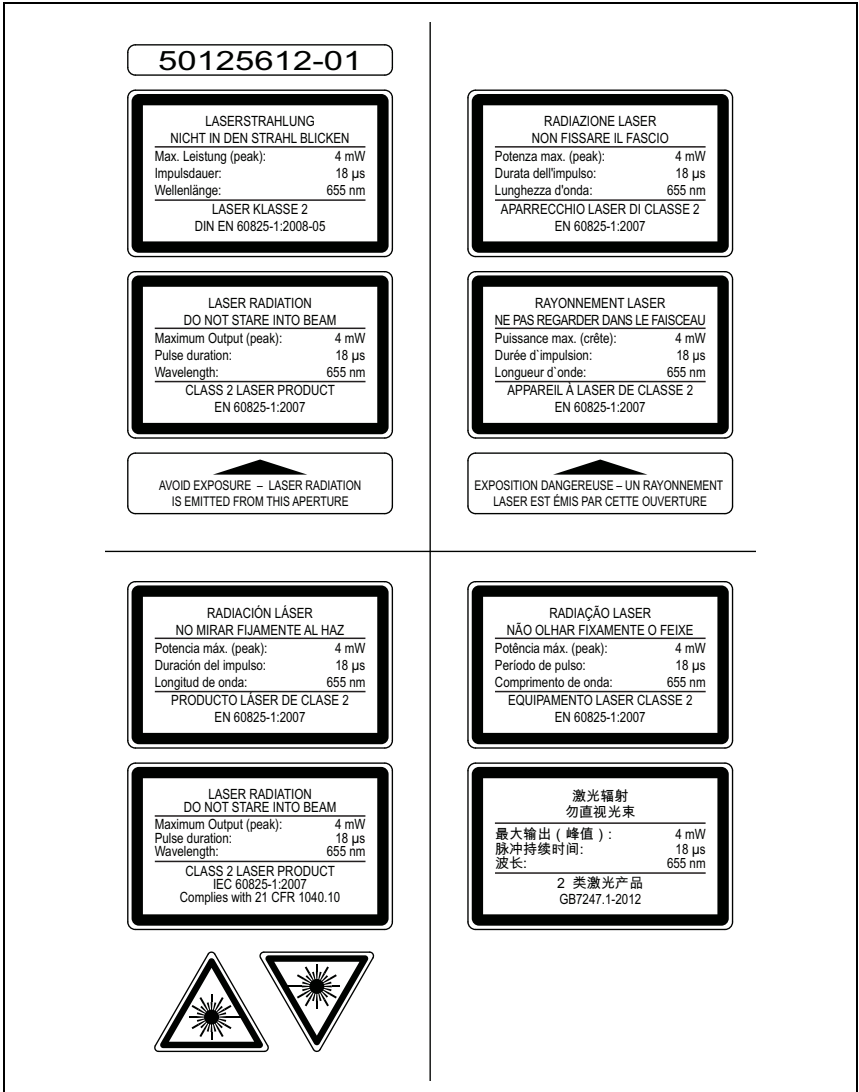

Figure 2.2: Laser warning and information signs – supplied stick-on labels

3 Fast commissioning / operating principle

**Notice!**

Below, you will find a **short description for the initial commissioning** of the AMS 348*i* SSI. Detailed explanations for the listed points can be found throughout the handbook.

3.1 Mounting the AMS 348*i* SSI

The AMS 348*i* and the corresponding reflector are mounted on two mutually opposing, plane-parallel, flat walls.



Figure 3.1: Schematic illustration of mounting

**Attention!**

For error-free position measurement, there must be an unobstructed line-of-sight between the AMS 348*i* and the reflector.

3.1.1 Mounting the device

The laser is mounted using 4 screws (M5).

Alignment is performed using 2 adjustment screws. Adjust so that the laser light spot is positioned at the center of the reflector. The alignment is to be secured with the knurled nut and locked with the M5 nut.

Further information can be found in chapter 5.2 and chapter 5.3.

3.1.2 Reflector mounting

The reflector is mounted using 4 screws (M5). The reflector is angled using the spacer sleeves included. Incline the reflector by approx. 1°.

Detailed information can be found in chapter 6.4.

3.2 Connecting the voltage supply

The laser measurement system is connected using M12 connectors. The voltage supply is connected via the PWR M12 connection (18 ... 30VDC). 2 freely programmable switching inputs/outputs for individual adaptation to the respective application are also available here.

Detailed information can be found in chapter 7.

3.3 Display

Once the laser measurement system is supplied with voltage, the device status as well as the measured position values can be read on the display. The display automatically switches to the display of the measurement values.

Use the up/down buttons (▲ ▼) to the left of the display to read and change a wide range of data and parameters.

Detailed information can be found in chapter 8.

3.4 AMS 348*i* SSI on the PROFINET

Install the GSDML file associated with the AMS 348*i* SSI in the PROFINET Manager of your control. Activate the desired modules (at least one module).

The network address for PROFINET is assigned via the PROFINET Manager.

Standalone operation in PROFINET

During standalone operation of the AMS 348*i* SSI, the PROFINET network is connected to BUS IN. BUS OUT requires no terminating resistor.

Network operation in PROFINET

In network mode the AMS 348*i* SSI is connected to PROFINET via BUS IN. Further PROFINET participants can be connected to the integrated switch of the AMS 348*i* SSI via the BUS OUT connection.

Commissioning of the AMS 348*i* SSI

The procedures described below are for the configuration of an AMS 348*i* SSI with a Siemens Simatic S7 PLC.

- Switching on the supply voltage.
The AMS 348*i* SSI displays the "**Status and measurement data**" main menu.
- Installation of the corresponding GSD file in the Simatic Hardware Manager.
- Projection of the PROFINET network including the AMS 348*i* SSI GSD file. Definition of the IP addresses, sub-network mask and definition of a device name assigned to the IP address.
- Download of the project to the connected Siemens control.

Further information regarding the individual commissioning steps is provided in see chapter 9.8.4 "Configuration steps for a Siemens Simatic S7 control".

Detailed information can be found in chapter 9.

4 Specifications

4.1 Specifications of the laser measurement system

4.1.1 General specifications AMS 348*i* SSI

Measurement data	AMS 348 <i>i</i> 40 (H) SSI	AMS 348 <i>i</i> 120 (H) SSI	AMS 348 <i>i</i> 200 (H) SSI	AMS 348 <i>i</i> 300 (H) SSI
Measurement range	0.2 ... 40 m	0.2 ... 120 m	0.2 ... 200 m	0.2 ... 300 m
Accuracy	± 2 mm	± 2 mm	± 3 mm	± 5 mm
Consistency ¹⁾	0.3 mm	0.5 mm	0.7 mm	1.0 mm
Light spot diameter	≤ 40 mm	≤ 100 mm	≤ 150 mm	≤ 225 mm
Measurement value output			1.7 ms	
Integration time			8 ms	
Resolution		adjustable, see chapter of the individual interfaces		
Temperature drift			≤ 0.1 mm/K	
Ambient temperature sensitivity			1 ppm/K	
Air pressure sensitivity			0.3 ppm/hPa	
Traverse rate			≤ 10 m/s	
Electrical data				
Supply voltage V_{in} ²⁾			18 ... 30VDC	
Current consumption			without device heating: ≤ 250 mA / 24VDC with device heating: ≤ 500 mA / 24VDC	
Optical data				
Transmitter		laser diode, red light, wavelength 650 ... 690 nm		
Laser class		2 in accordance with IEC 60825-1:2007, CDRH		
PROFINET interface				
Interface type		PROFINET-RT with integrated switch for BUS IN and BUS OUT		
Protocol		PROFINET-RT communication		
Conformance Class		B		
SSI interface				
Interface type		SSI interface		
SSI clock rate		50 kHz ... 800 kHz		
Data format		see chapter 10.4		
Operating and display elements				
Keyboard		4 buttons		
Display		monochromatic graphical display, 128 x 64 pixels		
LED		4 LEDs, 2 of which are used to display the PROFINET connection		

Inputs/outputs

Quantity	2, programmable
Input	protected against polarity reversal
Output	max. 60 mA, short-circuit proof

Mechanical data

Housing	cast zinc and aluminum
Optics	glass
Weight	approx. 2.45 kg
Degree of protection	IP 65 acc. to EN 60529 ³⁾

Environmental conditions

Operating temperature	
without device heating	-5 °C ... +50 °C
with device heating	-30 °C ... +50 °C ⁴⁾
Storage temperature	-30 °C ... +70 °C
Air humidity	max. 90% rel. humidity, non-condensing

Mechanical/electrical loading capacity

Vibrations	acc. to EN 60068-2-6
Noise	acc. to EN 60060-2-64
Shock	acc. to EN 60068-2-27
EMC	acc. to EN 61000-6-2 and EN 61000-6-4 ⁵⁾

- 1) Statistical error: 1 sigma; minimum switch-on time: 2 min.
- 2) For UL applications: only for use in "Class 2" circuits acc. to NEC.
- 3) With screwed-on M12 plugs or mounted caps.
- 4) With devices with heating, the switch on/off area of the internal heating can be extended to prevent condensation from forming. A 100% prevention of the formation of condensation cannot be guaranteed due to the limited heating capacity of the AMS 348i SSI.
- 5) This is a Class A product. In a domestic environment this product may cause radio interference, in which case the operator may be required to take adequate measures.



The AMS 348i SSI is designed in accordance with safety class III for supply with PELV (protective extra-low voltage).

4.1.2 Dimensioned drawing AMS 348*i* SSI

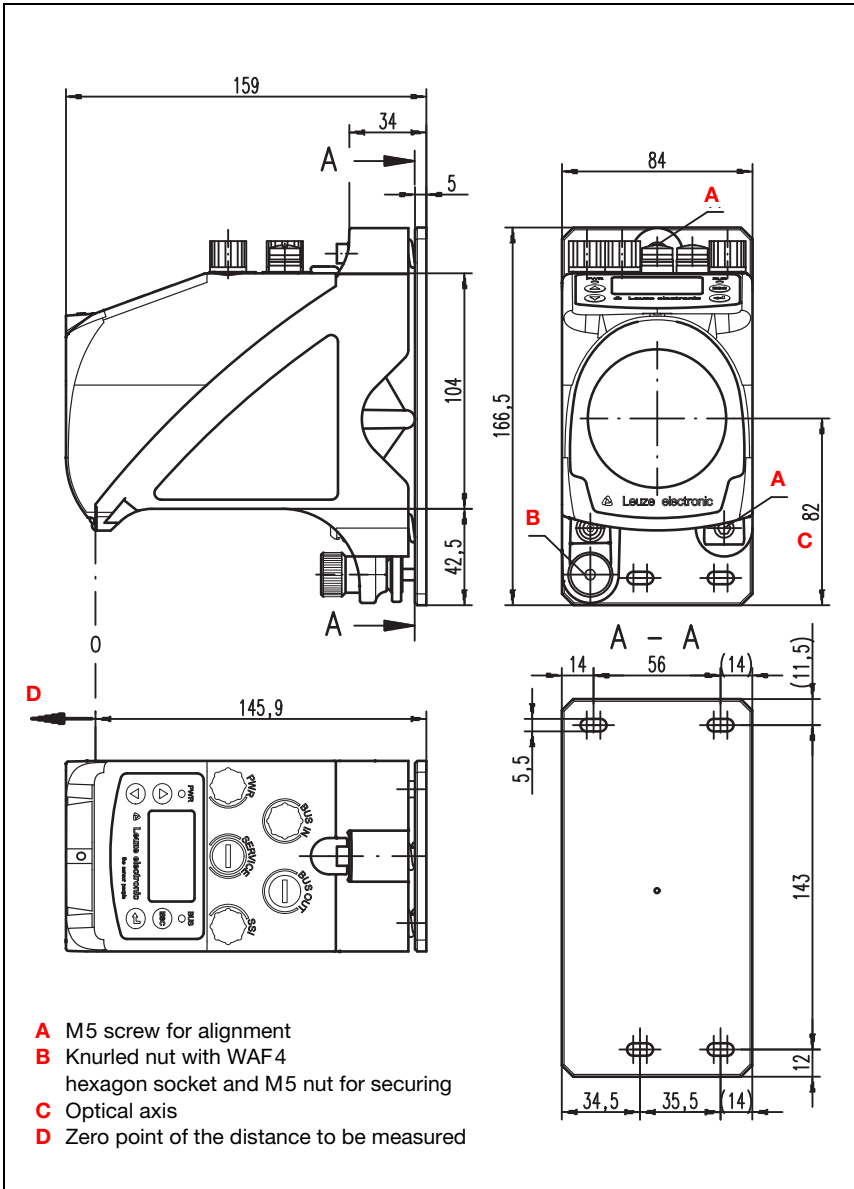

Figure 4.1: Dimensioned drawing AMS 348*i* SSI

4.1.3 Type overview AMS 348*i* SSI

AMS 348*i* SSI (PROFINET + SSI)

Type designation	Description	Part no.
AMS 348/40 SSI	40m operating range, PROFINET/SSI interface	50127219
AMS 348/120 SSI	120m operating range, PROFINET/SSI interface	50127220
AMS 348/200 SSI	200m operating range, PROFINET/SSI interface	50127221
AMS 348/300 SSI	300m operating range, PROFINET/SSI interface	50127222
AMS 348/40 H SSI	40m operating range, PROFINET/SSI interface, integrated heating	50127223
AMS 348/120 H SSI	120m operating range, PROFINET/SSI interface, integrated heating	50127224
AMS 348/200 H SSI	200m operating range, PROFINET/SSI interface, integrated heating	50127225
AMS 348/300 H SSI	300m operating range, PROFINET/SSI interface, integrated heating	50127226

Table 4.1: Type overview AMS 348*i* SSI

5 Installation and mounting

5.1 Storage, transportation



Attention!

When transporting or storing, package the device so that it is protected against collision and humidity. Optimum protection is achieved when using the original packaging. Heed the required environmental conditions specified in the technical data.

Unpacking

- ✎ Check the packaging for any damage. If damage is found, notify the post office or shipping agent as well as the supplier.
- ✎ Check the delivery contents using your order and the delivery papers:
 - Delivered quantity
 - Device type and model as indicated on the nameplate
 - Brief manual

The name plate provides information as to what AMS 348*i* SSI type your device is. For specific information, please refer to chapter 12.2.

Name plates

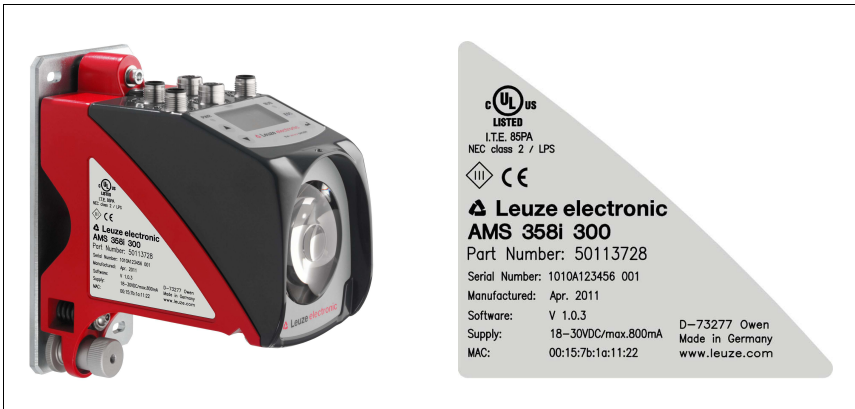

Figure 5.1: Device name plate using the AMS 358*i* as an example



Notice!

Please note that the shown name plate is for illustration purposes only; the contents do not correspond to the original.

- ✎ Save the original packaging for later storage or shipping.

If you have any questions concerning your shipment, please contact your supplier or your local Leuze electronic sales office.

↳ Observe the applicable local regulations when disposing of the packaging materials.

5.2 Mounting the AMS 348i SSI

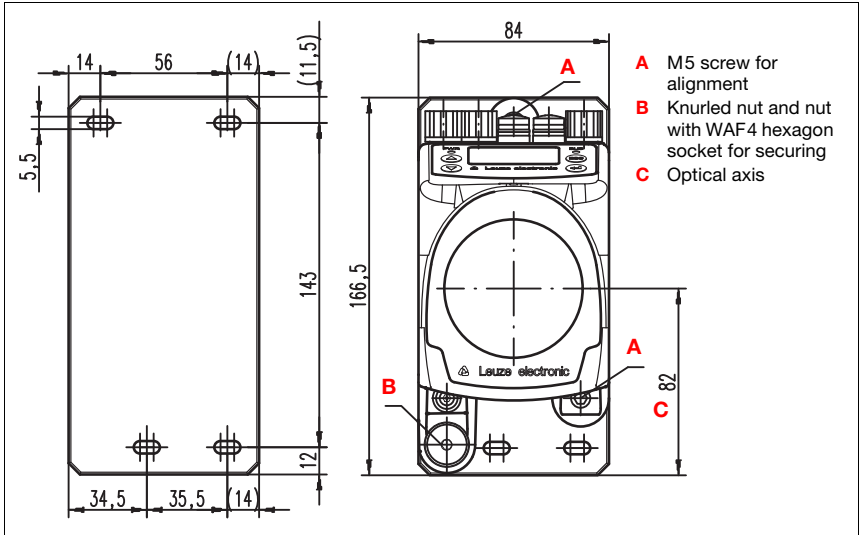

Figure 5.2: Mounting the device

The AMS 348i SSI and the corresponding reflector are mounted on two mutually opposing, plane-parallel, flat walls or system parts. For error-free position measurement, there must be an unobstructed line-of-sight connection between the AMS 348i SSI and the reflector.

Use M5 screws to fasten the laser measurement system. Secure the screws with a toothed lock washer to protect against loosening caused by vibrations.

Aligning the laser light spot in the center of the reflector

The laser light spot has to be aligned so that it always hits the center of the opposing reflector, both at close range as well as at the maximum measurement distance. **To align, use the two M5 Allen screws ("A" in figure 5.2).** When aligning please ensure that the knurled nut and the lock nut ("B" in figure 5.2) are opened wide.



Attention!

To prevent the laser measurement system from moving out of alignment during continuous operation, subsequently hand-tighten the knurled nut and counterlock with the nut with WAF4 hexagon socket ("B" in figure 5.2). Knurled nut and nut must not be tightened until alignment has been completed.



Attention!

The device must not be opened. Failure to comply will render the guarantee void. Warranted features cannot be guaranteed after the device has been opened.

5.2.1 Optional mounting bracket

A mounting bracket for mounting the AMS 348*i* SSI on a flat, horizontal surface is available as an optional accessory.

Type designation: MW OMS/AMS 01

Part no.: 50107255

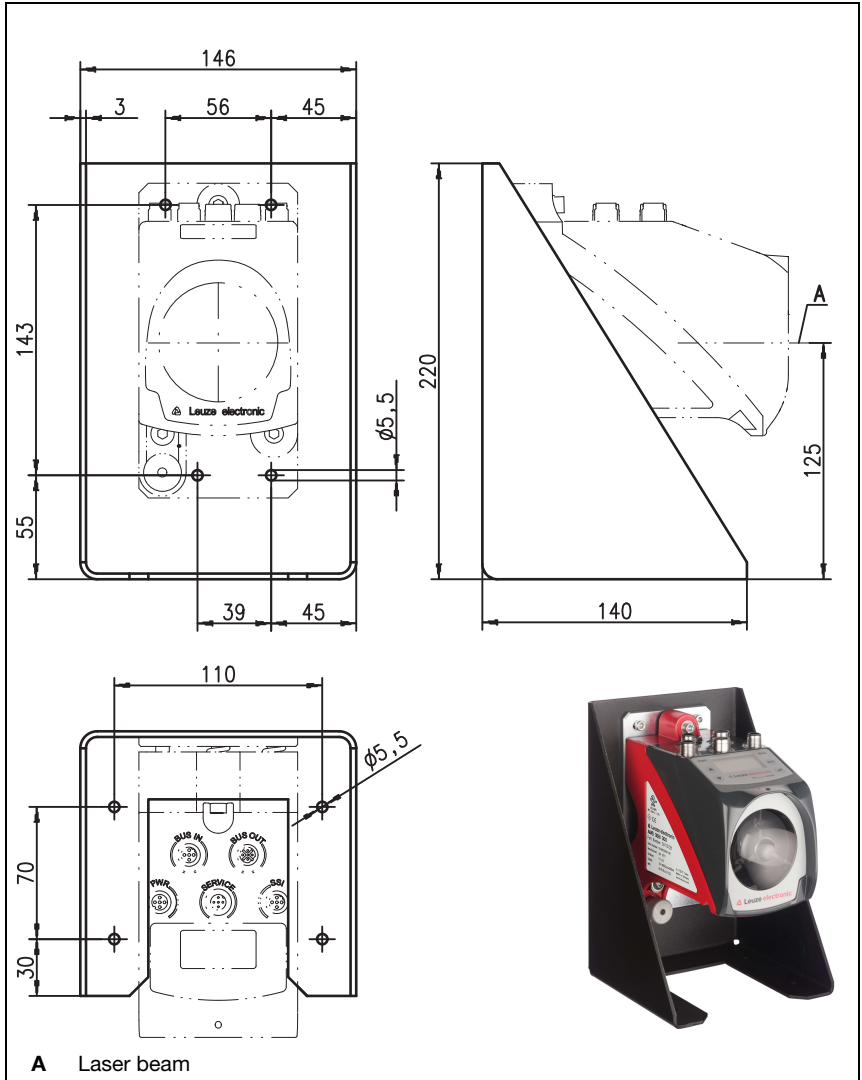

Figure 5.3: Optional mounting bracket

5.2.2 Parallel mounting of the AMS 348*i* SSI

Definition of the term "parallel spacing"

As shown in figure 5.4, dimension X describes the "parallel spacing" of the inner edges of the two laser light spots on the reflector.

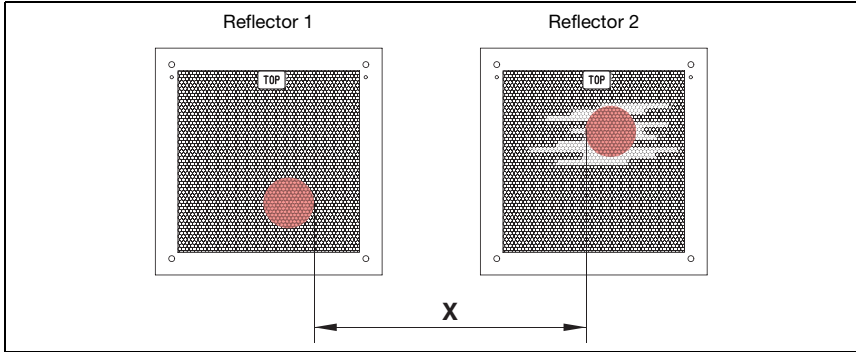

Figure 5.4: Minimum parallel spacing X between adjacent AMS 348*i* SSI

The diameter of the light spot increases with distance.

	AMS 348 <i>i</i> 40 (H) SSI	AMS 348 <i>i</i> 120 (H) SSI	AMS 348 <i>i</i> 200 (H) SSI	AMS 348 <i>i</i> 300 (H) SSI
Max. measurement distance	40m	120m	200m	300m
Light spot diameter	≤ 40mm	≤ 100mm	≤ 150mm	≤ 225mm

Thus, the center-to-center spacing of the two AMS 348*i* SSI devices with respect to one another can be calculated as a function of the maximum measurement distance.

To define the minimum parallel spacing between two AMS 348*i* SSI, it is necessary to distinguish between three different arrangements of AMS 348*i* SSI and reflectors.

The AMS 348*i* SSI are mounted stationary and in parallel on one plane. Both reflectors move independently of one another at different distances to the AMS 348*i* SSI.

Minimum parallel spacing X of the two laser light spots:

$$X = 100\text{mm} + (\text{max. measurement distance in mm} \times 0.01)$$

The AMS 348*i* SSI are mounted stationary and in parallel on one plane. Both reflectors move in parallel at the same distance to the AMS 348*i* SSI.

Measurement distance **up to 120m**: minimum parallel spacing **X ≥ 600mm**

Measurement distance **up to 200m**: minimum parallel spacing **X ≥ 750mm**

Measurement distance **up to 300m**: minimum parallel spacing **X ≥ 750mm**

The reflectors are mounted stationary and in parallel on one plane.

Both AMS 348i SSI move independently of one another at different or the same distances to the reflectors.

Measurement distance **up to 120m**: minimum parallel spacing **X ≥ 600mm**

Measurement distance **up to 200m**: minimum parallel spacing **X ≥ 750mm**

Measurement distance **up to 300m**: minimum parallel spacing **X ≥ 750mm**



Notice!

Please note that when the AMS 348i SSI are mounted in a mobile manner, travel tolerances could cause the two laser light spots to move towards each other.

Take the travel tolerances of the vehicle into account when defining the parallel spacing of adjacent AMS 348i SSI.

5.2.3 Parallel mounting of AMS 348i SSI and DDLS optical data transmission

The optical data transceivers of the DDLS series and the AMS 348i SSI do not interfere with one another. Depending on the size of the used reflector, the DDLS can be mounted with a minimum parallel spacing of 100mm to the AMS 348i SSI. The parallel spacing is independent of the distance.

5.3 Mounting the AMS 348*i* SSI with laser beam deflector unit

General information

The two available deflector units are used for the 90° deflection of the laser beam, see "Accessory deflector unit" on page 112.



Attention!

The deflector units are designed for a maximum range of 40m. Longer distances on request.

5.3.1 Mounting the laser beam deflector unit With integrated mounting bracket

The AMS 348*i* SSI is screwed onto the mechanism of the US AMS 01 deflector unit. The mirror can be mounted for three deflection directions:

1. Upward beam deflection
2. Beam deflection to the left
3. Beam deflection to the right

The deflector unit is mounted on plane-parallel, flat walls or plant components. For error-free position measurement, there must be an interruption-free line-of-sight between the AMS 348*i* SSI... and the deflection mirror as well as between the mirror and the reflector.

Use the M5 screws to mount the deflector unit. Secure the screws with a toothed lock washer to protect against loosening caused by vibrations.

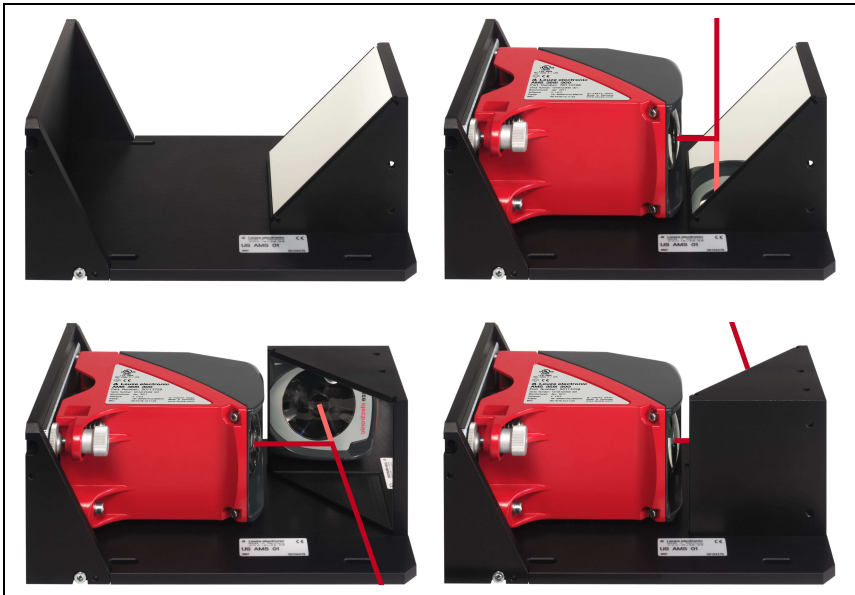

Figure 5.5: Mounting variants of the US AMS 01 laser beam deflector unit

5.3.3 Mounting the US 1 OMS deflector unit without mounting bracket

The US 1 OMS deflector unit and the AMS 348*i* SSI are mounted separately.



Notice!

When mounting, make certain that the laser light spot of the AMS 348*i* SSI is aligned in the center of the deflection mirror.

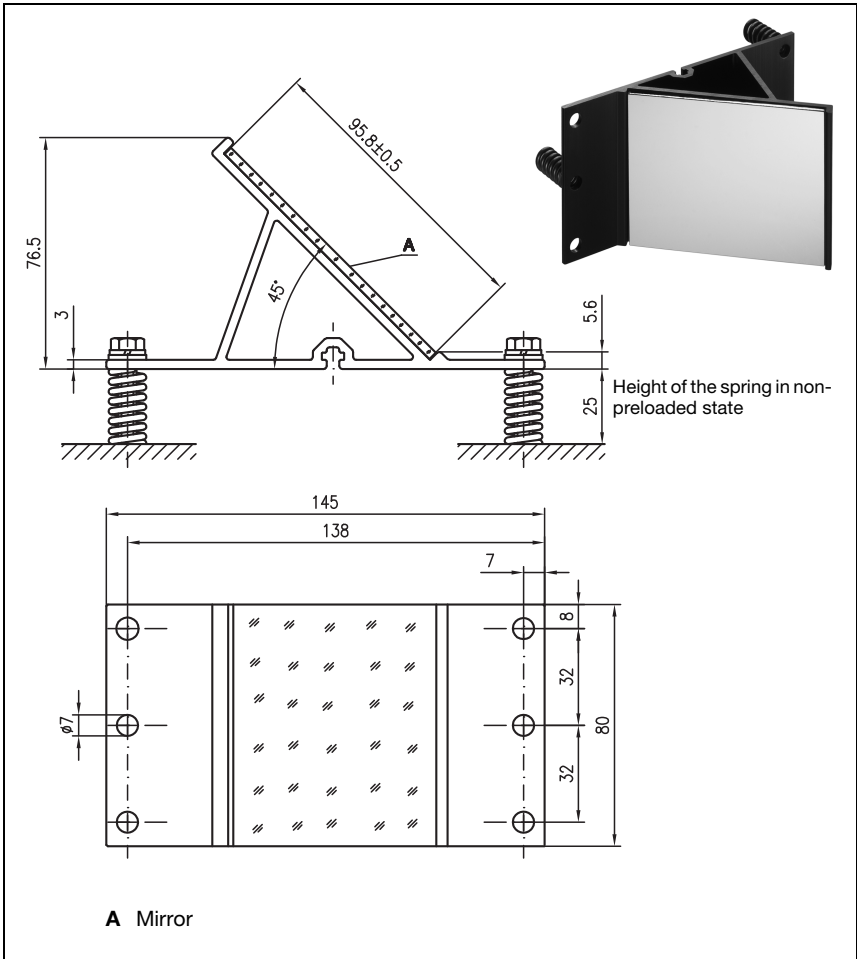

Figure 5.7: Photo and dimensioned drawing of the US 1 OMS deflector unit

Alignment of the laser light spot on the reflector is performed as described in chapter 5.2.

6 Reflectors

6.1 General information

The AMS 348*i* SSI measures distances against a reflective tape specified by Leuze electronic. All provided specifications for the AMS 348*i* SSI, such as the operating range or accuracy, can only be achieved with the reflective tape specified by Leuze electronic.

The reflective tapes are available as adhesive tapes, affixed to a metal plate and with an integrated heater especially for use at low temperatures. Reflective tapes with heating have the designation "**Reflective tape ...x...-H**", where "**H**" is an abbreviation for the heating variant.

The reflective tapes/reflectors must be ordered separately. The choice of size is left to the user. In Chapter 6.3, recommendations on reflector size are provided as a function of the distance that is to be measured. In any case, the user must check to determine whether the recommendation is suitable for the respective application.

6.2 Description of the reflective tape

The reflective tape consists of a white, microprism-based reflective material. The microprisms are protected with a highly transparent, hard protective layer.

Under certain circumstances, the protective layer may lead to surface reflections. The surface reflections can be directed past the AMS 348*i* SSI by positioning the reflective tape at a slight incline. The inclination of the reflective tape/reflectors is described in Chapter 6.4.2. The required pitch can be found in table 6.1 "Reflector pitch resulting from spacer sleeves" on page 36.

The reflective tapes are provided with a protective foil that can easily be pulled off. This must be removed from the reflector before the complete system is put into operation.

6.2.1 Specifications of the self-adhesive foil

	Part		
Type designation	Reflective tape 200x200-S	Reflective tape 500x500-S	Reflective tape 914x914-S
Part no.	50104361	50104362	50108988
Foil size	200x200mm	500x500mm	914x914mm
Recommended application temperature for adhesive tape	+5°C ... +25°C		
Temperature resistance, affixed	-40°C ... +80°C		
Mounting surface	The mounting surface must be clean, dry and free of grease.		
Cutting the tape	Cut with a sharp tool, always on the side of the prism structure.		
Cleaning	Do not use any agents that act with a grinding effect. A conventional household detergent can be used as a cleaning agent. Rinse with clear water and dry the surface.		
Storing the foil	Store in a cool and dry place.		

6.2.2 Specifications of the reflective tape on a metal plate

The reflective tape is affixed to a metal plate. Included with the metal plate are spacers for positioning at an incline - for avoiding surface reflections - (see chapter 6.4.2 "Mounting the reflector").

	Part		
Type designation	Reflective tape 200x200-M	Reflective tape 500x500-M	Reflective tape 914x914-M
Part no.	50104364	50104365	50104366
Foil size	200x200mm	500x500mm	914x914mm
Outer dimensions of the metal plate	250x250mm	550x550mm	964x964mm
Weight	0.8kg	4kg	25kg
Cleaning	Do not use any agents that act with a grinding effect. A conventional household detergent can be used as a cleaning agent. Rinse with clear water and dry the surface.		
Storing the reflector	Store in a cool and dry place.		

6.2.3 Dimensioned drawing of reflective tape on a metal plate

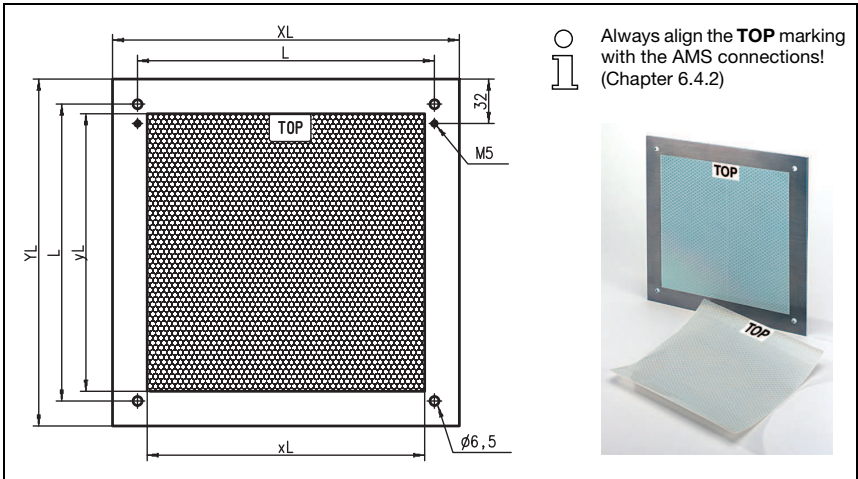

Figure 6.1: Dimensioned drawing of reflectors

Part	Reflective tape (mm)		Reflector plate (mm)		
	xL	yL	XL	YL	L
Reflective tape 200x200-M	200	200	250	250	214
Reflective tape 500x500-M	500	500	550	550	514
Reflective tape 914x914-M	914	914	964	964	928

6.2.4 Specifications of heated reflectors

The reflective tape is affixed to a heated, thermally insulated base. The insulation results in a very high energetic efficiency.

Only the reflective tape is kept at the specified temperature by the integrated heater. Through the insulation on the back, the generated heat cannot be transferred via the steel construction. Energy costs are greatly reduced in the case of continuous heating.

Type designation	Part		
	Reflective tape 200x200-H	Reflective tape 500x500-H	Reflective tape 914x914-H
Part no.	50115020	50115021	50115022
Voltage supply	230VAC		
Power	100W	600W	1800W
Current consumption	~ 0.5A	~ 3A	~ 8A
Length of the supply line	2 m		
Size of the reflective tape	200x200mm	500x500mm	914x914mm
Outer dimensions of the base material	250x250mm	550x550mm	964x964mm
Weight	0.5kg	2.5kg	12kg
Temperature control	Controlled heating with the following switch-on and switch-off temperatures, measured at the reflector surface.		
Switch-on temperature	~ 5°C		
Switch-off temperature	~ 20°C		
Operating temperature	-30°C ... +70°C		
Storage temperature	-40°C ... +80°C		
Air humidity	Max. 90%, non-condensing.		
Cleaning	Do not use any agents that act with a grinding effect. A conventional household detergent can be used as a cleaning agent. Rinse with clear water and dry the surface.		
Storing the reflector	Store in a cool and dry place.		

6.2.5 Dimensioned drawing of heated reflectors

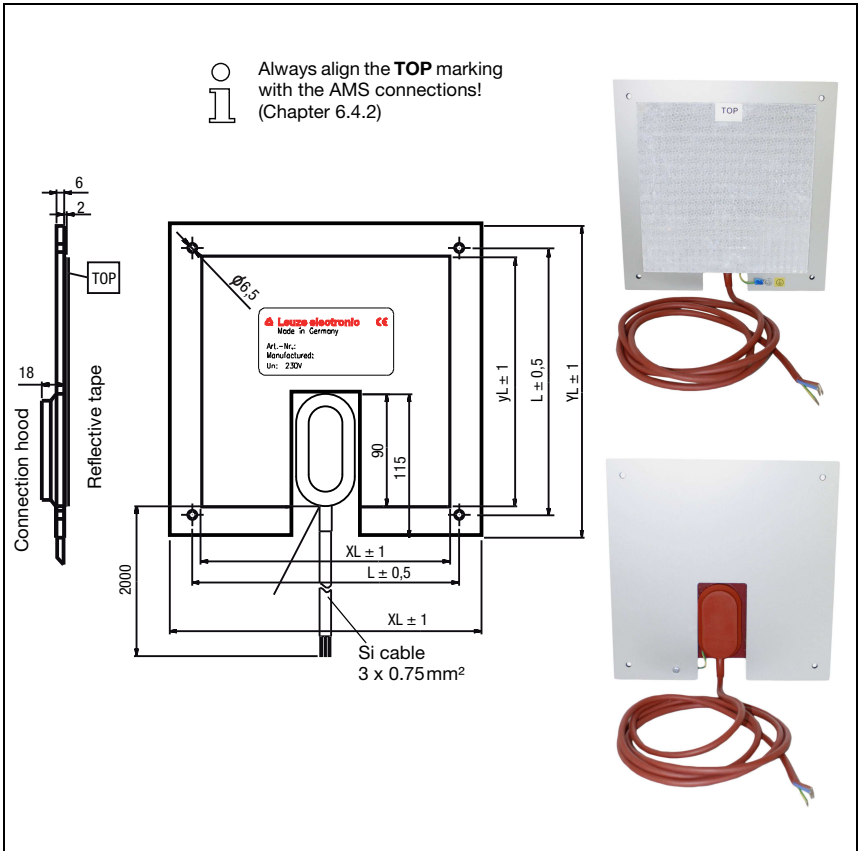

Figure 6.2: Dimensioned drawing of heated reflectors

Part	Reflective tape (mm)		Insulated base plate (mm)		
	xL	yL	XL	YL	L
Reflective tape 200x200-H	200	200	250	250	214
Reflective tape 500x500-H	500	500	550	550	514
Reflective tape 914x914-H	914	914	964	964	928

6.3 Selecting reflector sizes

Depending on system design, the reflector can be mounted so that it travels on the vehicle or it can be mounted at a fixed location.



Attention!

The reflector sizes shown below are a recommendation from Leuze electronic for on-vehicle mounting of the AMS 348*i* SSI. For stationary mounting of the AMS 348*i* SSI, a smaller reflector is generally sufficient for all measurement distances.

On the basis of the system planning and design, always check whether mechanical travel tolerances may require the use of a reflector larger than that which is recommended. This applies, in particular, when the laser measurement system is mounted on a vehicle. During travel, the laser beam must reach the reflector without interruption. For on-vehicle mounting of the AMS 348*i* SSI, the reflector size must accommodate any travel tolerances that may arise and the associated "wandering" of the light spot on the reflector.

Overview of reflector types

Recommended reflector sizes			
AMS 348 <i>i</i> SSI selection (operating range in m)	Recommended reflector size (H x W)	Type designation ...-S = self-adhesive ...-M = metal plate ...-H = heating	Part no.
AMS 348 <i>i</i> 40 (H) SSI (max. 40m)	200x200mm	Reflective tape 200x200-S	50104361
		Reflective tape 200x200-M	50104364
		Reflective tape 200x200-H	50115020
AMS 348 <i>i</i> 120 (H) SSI (max. 120m)	500x500mm	Reflective tape 500x500-S	50104362
		Reflective tape 500x500-M	50104365
		Reflective tape 500x500-H	50115021
AMS 348 <i>i</i> 200 (H) SSI (max. 200m)	749x914mm 914x914mm	Reflective tape 749x914-S	50104363
		Reflective tape 914x914-M	50104366
		Reflective tape 914x914-S	50108988
		Reflective tape 914x914-H	50115022
AMS 348 <i>i</i> 300 (H) SSI (max. 300m)	749x914mm 914x914mm	Reflective tape 749x914-S	50104363
		Reflective tape 914x914-M	50104366
		Reflective tape 914x914-S	50108988
		Reflective tape 914x914-H	50115022

6.4 Mounting the reflector

6.4.1 General information

Self-adhesive reflective tapes

The reflective tapes of the "Reflective tape ...x...-S" self-adhesive series must be affixed to a flat, clean and grease-free surface. We recommend using a separate metal plate, which is to be provided on-site.

As described in table 6.1, the reflective tape must be angled.

Reflective tapes on metal

The reflective tapes of the "Reflective tape ...x...-M" series are provided with corresponding mounting holes. Spacer sleeves are provided in the packet for achieving the necessary pitch angle. For further information see table 6.1.

Heated reflectors

The reflective tapes of the "Reflective tape ...x...-H" series are provided with corresponding mounting holes. Due to the voltage supply affixed on the rear, the reflector cannot be mounted flat. Included in the package are four distance sleeves in two different lengths. Use the distance sleeves to achieve a base separation to the wall as well as the necessary pitch for avoiding surface reflection. For further information see table 6.1.

The reflector is provided with a 2m-long connection cable for supplying with 230VAC. Connect the cable to the closest power outlet. Observe the current consumptions listed in the specifications.



Attention!

Connection work must be carried out by a certified electrician.

6.4.2 Mounting the reflector

The combination of laser measurement system and reflective tape/reflector is mounted so that the laser light spot hits the tape as centered as possible and without interruption.

For this purpose, use the alignment elements provided on the AMS 348i SSI... (see chapter 5.3 "Mounting the AMS 348i SSI with laser beam deflector unit"). If necessary, remove the protective foil from the reflector.



Attention!

The "TOP" label mounted on the reflectors should be aligned the same as the connections of the AMS 348i SSI.

Example:

If the AMS 348i SSI is mounted so that the M12 connections are on the top, the "TOP" label of the reflector is also on the top. If the AMS 348i SSI is mounted so that the M12 connections are on the side, the "TOP" label of the reflector is also on the side.



Notice!

The reflector must be angled. To do this, use the spacer sleeves. Angle the reflectors so that the **surface reflections of the foil seal are deflected to the left, right or upwards**. Chapter 6.4.3 gives the correct pitch with respect to the reflector size and, thus, the length of the spacers.

Reflective tapes ...-S and ...-M

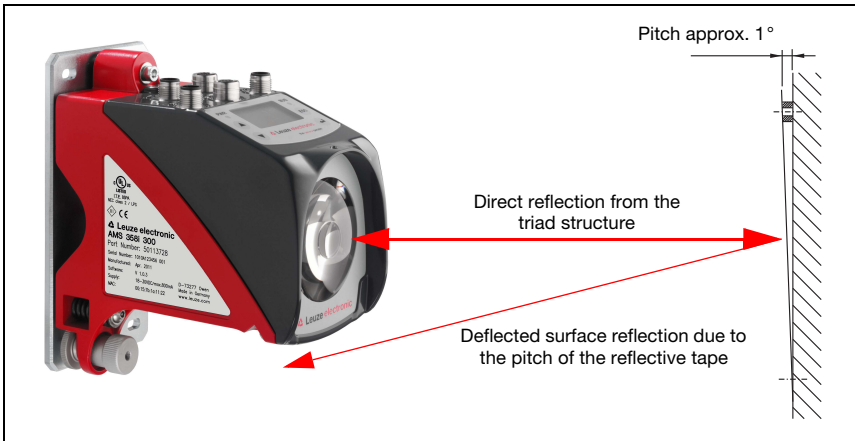

Figure 6.3: Reflector mounting

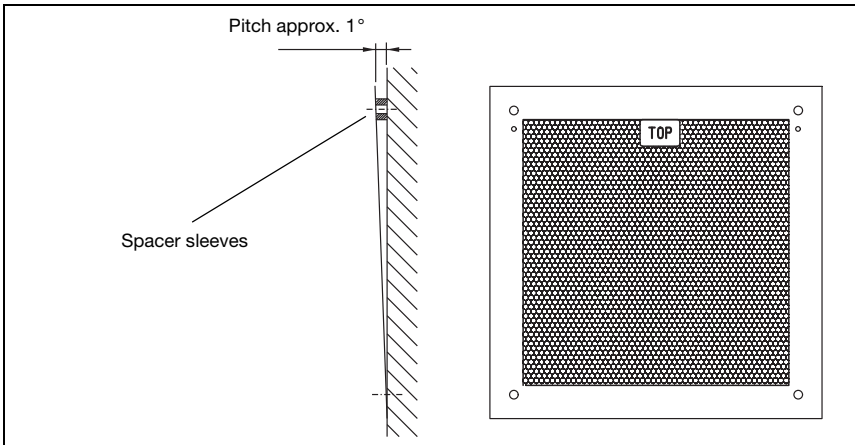

Figure 6.4: Pitch of the reflector

Reflective tapes ...-H

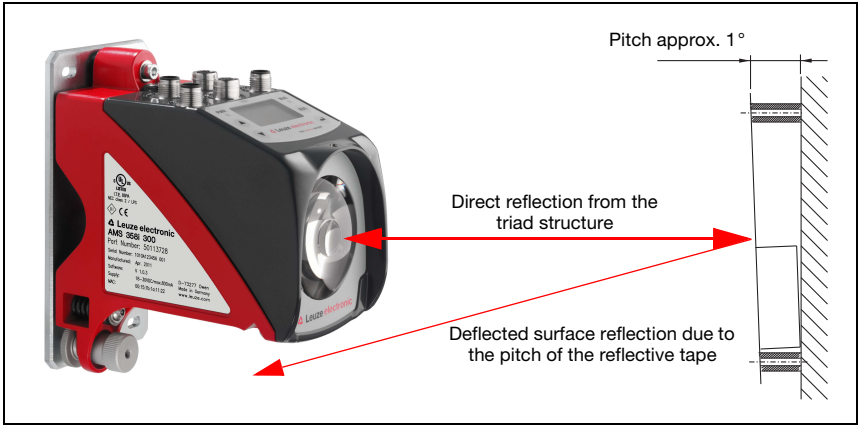

Figure 6.5: Mounting of heated reflectors

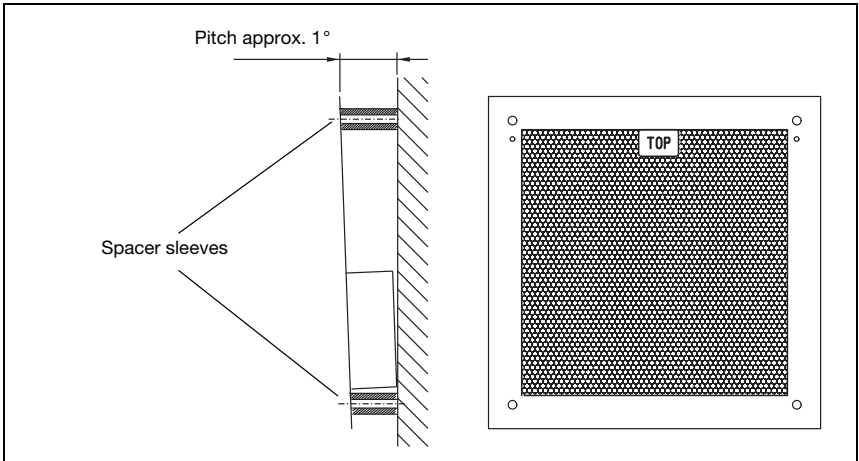

Figure 6.6: Pitch of the heated reflector

6.4.3 Table of reflector pitches

Reflector type	Pitch resulting from spacer sleeves ¹⁾	
Reflective tape 200x200-S Reflective tape 200x200-M	2 x 5mm	
Reflective tape 200x200-H	2 x 15mm	2 x 20mm
Reflective tape 500x500-S Reflective tape 500x500-M	2 x 10mm	
Reflective tape 500x500-H	2 x 15mm	2 x 25mm
Reflective tape 749x914-S	2 x 20mm	
Reflective tape 914x914-S Reflective tape 914x914-M	2 x 20mm	
Reflective tape 914x914-H	2 x 15mm	2 x 35mm

1) Spacer sleeves are included in the delivery contents of reflective tape ...-M and ...-H

Table 6.1: Reflector pitch resulting from spacer sleeves



Notice!

Reliable function of the AMS 348i SSI and, thus, max. operating range and accuracy can only be achieved with the reflective tape specified by Leuze electronic. No function can be guaranteed if other reflectors are used!

7 Electrical connection

The AMS 348*i* SSI laser measurement systems are connected using variously coded M12 connectors. This ensures unique connection assignments.



Notice!

The corresponding mating connectors and ready-made cables are available as accessories for all cables. For further information, see chapter 12 "Type overview and accessories".



Figure 7.1: Connections of the AMS 348*i* SSI

7.1 Safety notices for the electrical connection



Attention!

Before connecting the device, be sure that the supply voltage agrees with the value printed on the name plate.

The device may only be connected by a qualified electrician.

Ensure that the functional earth (FE) is connected correctly. Unimpaired operation is only guaranteed when the functional earth is connected properly.

If faults cannot be corrected, the device should be removed from operation and protected against possible use.



Attention!

For UL applications, use is permitted exclusively in Class 2 circuits according to NEC (National Electric Code).



The laser measurement systems are designed in accordance with safety class III for supply by PELV (protective extra-low voltage with reliable disconnection).

**Notice!**

Degree of protection IP65 is achieved only if the connectors and caps are screwed into place!

Described in detail in the following are the individual connections and pin assignments.

7.2 PWR – voltage supply / switching input/output

PWR (5-pin plug, A-coded)			
	Pin	Name	Remark
		1	VIN
	2	I/O 1	Switching input/output 1
	3	GND	Negative supply voltage 0VDC
	4	I/O 2	Switching input/output 2
	5	FE	Functional earth
	Thread	FE	Functional earth (housing)

Table 7.1: Pin assignment PWR

Further information on configuring the input/output can be found in chapter 8 and chapter 9.

7.3 PROFINET BUS IN

BUS IN (4-pin socket, D-coded)			
	Pin	Name	Remark
		1	TD+
	2	RD+	Receive Data +
	3	TD-	Transmit Data -
	4	RD-	Receive Data -
	Thread	FE	Functional earth (housing)

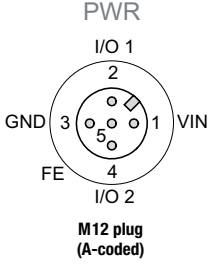
Table 7.2: Pin assignments for BUS IN

7.4 PROFINET BUS OUT

BUS OUT (4-pin socket, D-coded)			
 <p>BUS OUT RD+ 2 TD+ 1 3 TD- RD- 4 M12 socket (D-coded)</p>	Pin	Name	Remark
	1	TD+	Transmit Data +
	2	RD+	Receive Data +
	3	TD-	Transmit Data -
	4	RD-	Receive Data -
Thread	FE	Functional earth (housing)	

Table 7.3: Pin assignment BUS OUT

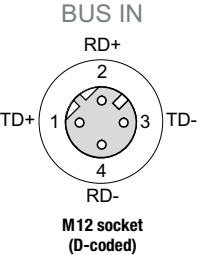
7.5 SSI

SSI (5-pin plug, B-coded)			
 <p>SSI DATA- 2 CLK+ 3 1 DATA+ FE 5 CLK- 4 M12 connector (B-coded)</p>	Pin	Name	Remark
	1	DATA+	+ Data line SSI (output)
	2	DATA-	- Data line SSI (output)
	3	CLK+	+ Clock line SSI (input electrically insulated)
	4	CLK-	- Clock line SSI (input electrically insulated)
	5	FE	Functional earth
	Thread	FE	Functional earth (housing)

Table 7.4: SSI pin assignment

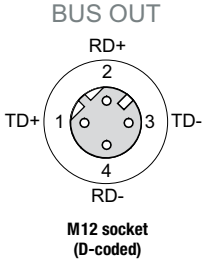
7.6 Service

Service (5-pin socket, A-coded)			
 <p>SERVICE</p> <p>RS232-TX</p> <p>NC 1 2 3 GND</p> <p>4 NC</p> <p>RS232-RX</p> <p>M12 socket (A-coded)</p>	Pin	Name	Remark
	1	NC	Not used
	2	RS232-TX	Transmission line RS 232/service data
	3	GND	Voltage supply 0VDC
	4	RS232-RX	Receiving line RS 232/service data
	5	NC	Not used
Thread	FE	Functional earth (housing)	

Table 7.5: Service pin assignments

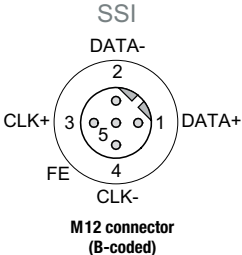

Notice!

The service interface is designed only for use by Leuze electronic!

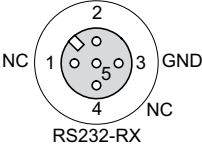
8 Display and control panel AMS 348i SSI

8.1 Structure of the control panel

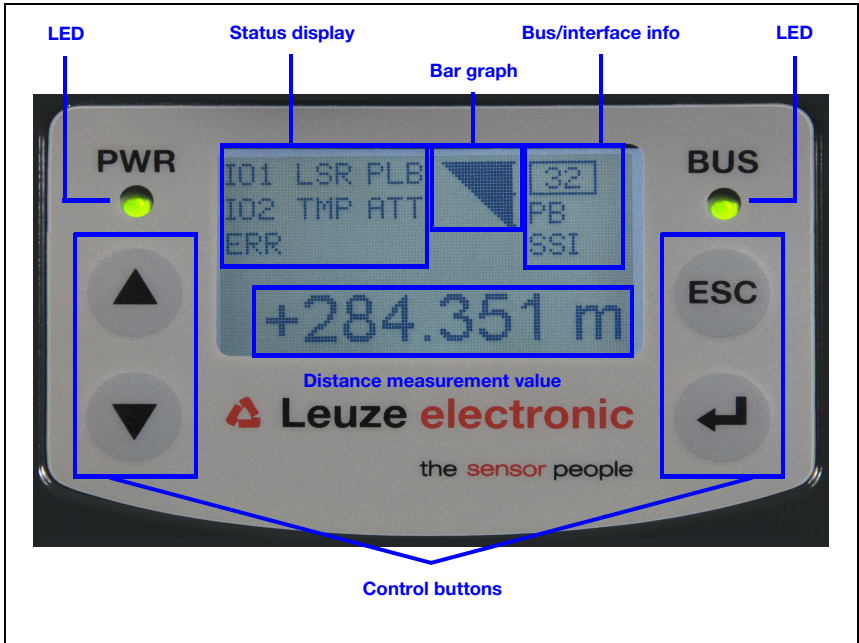

Figure 8.1: Structure of the control panel using the AMS 304i PROFIBUS device variant as an example



Notice!

The figure is for illustration purposes only and does not correspond to AMS 348i SSI with respect to bus/interface info.

8.2 Status display and operation

8.2.1 Indicators in the display

Status and warning messages in the display

- IO1 **Input 1 or output 1 active:**
Function depending on configuration.
- IO2 **Input 2 or output 2 active:**
Function depending on configuration.

- LSR **Warning - laser prefailure message:**
Laser diode old, device still functional, exchange or have repaired.
- TMP **Warning - temperature monitoring:**
Permissible internal device temperature exceeded / not met.
- PLB **Plausibility error:**
Implausible measurement value. Possible causes: light beam interruption, outside of measurement range, permissible internal device temperature considerably exceeded or traverse rate >10m/s.
Depending on the configuration, either zero or the last valid measurement value is output at the interfaces.
- ATT **Warning received signal:**
Laser outlet window or reflector soiled or fogged by rain, water vapor or fog. Clean or dry surfaces.
- ERR **Internal hardware error:**
The device must be sent in for inspection.

Bar graph



Indicates the **strength of the received laser light**.
The center bar represents the **ATT** warning threshold. The distance value remains valid and is output at the interfaces.
If no bar graph is available, the **PLB** status information appears at the same time. The measurement value has thus been assessed as being implausible. Depending on the configuration, either zero or the last valid measurement value is output at the interfaces.

Interface info

"LNK0" and "LNK1" in the display indicate an existing EtherNet connection for BUS IN and BUS OUT. If the status info "LNK0" or "LNK1" is not displayed although the data line is connected, the connection is faulty. The abbreviation "SSI" stands for an activated SSI interface.



- ← Display of existing EtherNet connections
- ← Display of activated SSI interface
- ← Maximum position value

The connection status is additionally signaled by a green/orange multicolor LED below the BUS IN and BUS OUT plug connector, see chapter "LINK LED for BUS IN and BUS OUT".

Position value

The measured position value is displayed in the configured unit of measurement.

+87.000m With the **metric** setting, the measurement value is always displayed in meters with **three decimal places**.

+87.0in With the **inch** setting, the measurement value is always displayed in inches with **one decimal place**.

8.2.2 LED status displays

PWR LED

PWR



Off

Device OFF

- No supply voltage

PWR



Flashing green

Power LED flashes green

- No measurement value output
- Voltage connected
- Self test running
- Initialization running
- Parameter download running
- Boot process running

PWR



Green continuous light

Power LED green

- AMS 348i SSI ok
- Measurement value output
- Self test successfully finished
- Device monitoring active

PWR



Red flashing

Power LED flashes red

- Device ok but warning message (ATT, TMP, LSR) set in display
- Light beam interruption
- Plausibility error (PLB)

PWR



Red continuous light

Power LED red

- No measurement value output; for details, see Display

PWR



Orange flashing

Power LED flashes orange

- PROFINET wave function

PWR



Orange continuous light **Power LED orange**

- Configuration via the display
- No data on the host interface

BUS LED

BUS



Off **BUS LED off**

- No supply voltage (Power)
- No communication possible
- PROFINET communication not initialized or inactive

BUS



Flashing green **BUS LED flashes green**

- Initialization of the AMS 348i SSI, establishing communication

BUS



Green continuous light **BUS LED green**

- Network operation ok
- Connection and communication to controller (PLC) established ("data exchange")

BUS



Red flashing **BUS LED flashes red**

- Bus error, communication error
- Parameterization or configuration failed ("parameter failure")
- IO error
- No data exchange

BUS



Red continuous light **BUS LED red**

- Bus error, network error
- No communication (protocol) to Controller established ("no data exchange")

BUS



Orange flashing **BUS LED flashes orange**

- PROFINET wave function

LINK LED for BUS IN and BUS OUT

A green/orange multicolor LED below the BUS IN and BUS OUT connectors indicates the EtherNet/PROFINET connection status.



Green continuous light

Power LINK green

- The link exists, the hardware connection to the next connected participant is OK. The LED signals the same status as "LNK0" and "LNK1" in the display.



Orange flashing

LINK LED flashes orange (ACT0/ACT1)

- Data is exchanged with the connected participants.

8.2.3 Control buttons



Up

Navigate upward/laterally.



Down

Navigate downward/laterally.



ESC

Exit menu item.



ENTER

Confirm/enter value, change menu levels.

Navigating within the menus

The menus within a level are selected with the up/down buttons .

The selected menu item is activated with the enter button .







Press the ESC button to move up one menu level.

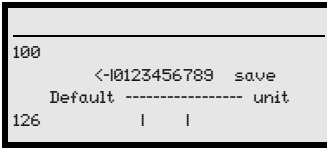



When one of the buttons is actuated, the display illumination is activated for 10min.



Setting values

If input of a value is possible, the display looks like this:



-  +  Delete character
-  ...  +  Enter digit
- save +  Save

Use the   and  buttons to set the desired value. An accidental, incorrect entry can be corrected by selecting <-| and then pressing .

Then use the   buttons to select save and save the set value by pressing .

Selecting options

If options can be selected, the display looks like this:

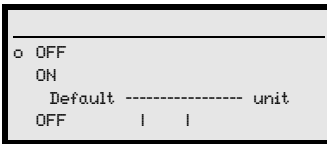

Select the desired option with the   buttons. Activate the option by pressing .

8.3 Menu description

8.3.1 The main menus

After voltage has been applied to the laser, device information is displayed for several seconds. The display then shows the measurement window with all status information.

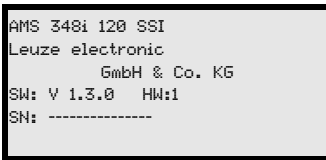

Device information - main menu

This menu item contains detailed information on

- Device model,
- Manufacturer,
- Software and hardware version,
- Serial number.

No entries can be made via the display.

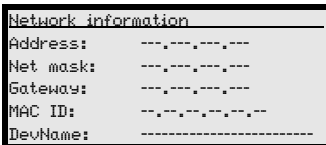

Network information - main menu

- Display of the network settings.

No entries can be made via the display.



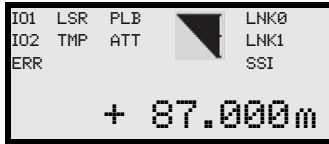

Status and measurement data - main menu

- Display of status-, warning-, and error messages.
- Status overview of the switching inputs/outputs.
- Bar graph for the reception level.
- Link.
- Measurement value.

No entries can be made via the display.
See "Indicators in the display" on page 41.

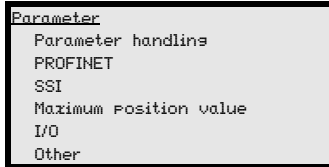

Parameter - main menu

- Configuration of the AMS.
- See "Parameter menu" on page 48.

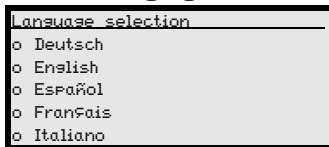

Language selection - main menu

- Selection of the display language.
- See "Language selection menu" on page 52.

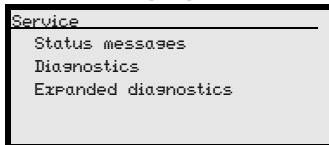

Service - main menu

- Display of status messages.
 - Display of diagnostic data.
- No entries can be made via the display.
See "Service menu" on page 52.



Notice!

The rear cover of this manual includes a **fold-out page** with the complete **menu structure**. It describes the menu items in brief.

A detailed description of the individual parameters can be found in the description of the PROFINET GSD modules (see chapter 9.9.2 "Overview of the GSD modules").



Attention!

If parameters are changed via the display during bus operation, the AMS 348i SSI is separated from the PROFINET at the moment parameter enabling is activated via the display. Parameters set by the PROFINET are moved to the background, and changes to parameters can be made via the display. When parameter enabling is exited, the AMS 348i SSI is automatically reconnected to the PROFINET. Upon connection to the PROFINET, the AMS 348i SSI receives all parameters from the PROFINET Controller (PLC).

Changes made via the display are overwritten!

Device settings for operating the AMS 348i SSI on the PROFINET are managed and configured exclusively by the PROFINET Controller (PLC).

8.3.2 Parameter menu

Parameter handling submenu

The following functions can be called up in the Parameter handling submenu:

- Lock and enable parameter entry
- Set up a password
- Reset the AMS 348i SSI to default settings.

Table 8.1: Parameter handling submenu

Level 3	Level 4	Level 5	Selection/configuration option Description	Standard
Parameter enabling			ON / OFF The standard setting (OFF) prevents unintended parameter changes. With parameter enabling activated (ON), the display is inverted. In this state, it is possible to change parameters manually. As long as parameter enabling is activated, the AMS 348i SSI is disconnected from the PROFINET.	OFF
Password	Activate password		ON / OFF To enter a password, parameter enabling must be activated. If a password is assigned, changes to the AMS 348i SSI can only be made after the password is entered. The master password 2301 bridges the individually set password.	OFF
	Password entry		Configuration option of a four-digit numerical password	
Parameters to default			By pressing the enter button  after selecting Parameters to default , all parameters are reset to their standard settings without any further security prompts. In this case, English is selected as the display language.	

Additional important information on parameter handling can be found at the end of the chapter.

PROFINET submenu

Table 8.2: PROFINET submenu

Level 3	Level 4	Level 5	Selection/configuration option Description	Standard
Activation			ON / OFF Activates or deactivates the AMS 348i SSI as an PROFINET participant. If the AMS 348i SSI is deactivated as a PROFINET participant, all subsequent participants connected via the internal switch (Bus OUT) continue to be active.	ON

SSI submenu

Table 8.3: SSI submenu

Level 3	Level 4	Level 5	Selection/configuration option Description	Standard
Activation			ON / OFF Activates or deactivates the AMS 348i SSI as an SSI participant.	ON
Coding			Binary/gray Specifies the output format of the measurement value.	Gray
Number of data bits			24-bit/25-bit/26-bit The measurement value can be displayed on the SSI interface in this data width.	24 bit
SSI resolution			0.001 mm / 0.01 mm / 0.1 mm / 1 mm / 10 mm / free resolution The measurement value can be displayed in these resolutions. The value of the free resolution is determined in the "Position value" sub-menu in the "Value of free resolution" parameter.	0.1 mm
Error bit			ON/OFF This parameter determines whether an error bit is also attached to the "number of data bits". The error bit is the LSB and is not converted in the case of gray representation of the measurement value.	ON
Error bit function			The error bit can be set with the following status messages: Overflow / intensity (ATT) / temperature (TMP) /laser (LSR) / plausibility (PLB) / hardware (ERR) In the case of multiple namings, the individual states in the error bit are processed in an OR function.	Plausibility (PLB) Hardware (ERR)
Clock frequency			50 - 79kHz / 80 - 800 kHz Selection of the clock frequency.	80 - 800kHz

Position value submenu



Notice!

The parameters mentioned in the "Position value", "I/O" and "Other" sub-menus must be set via the GSDML file of the AMS 348i SSI. For test purposes, the parameters can be changed directly on the AMS 348i SSI via the display structure described below. After deactivation of the parameter enable, however, the parameters stored in the GSDML file continue to be valid. The parameters changed directly on the AMS 348i SSI for test purposes are overwritten again.

Table 8.4: Position value submenu

Level 3	Level 4	Level 5	Selection/configuration option Description	Standard
Measurement unit			Metric/Inch Specifies the units of the measured distances	Metric
Count direction			Positive/Negative Positive: The measurement value begins at 0 and increases with increasing distance. Negative: The measurement value begins at 0 and decreases with increasing distance. Negative distance values may need to be compensated with an offset or preset.	Positive

Table 8.4: Position value submenu

Level 3	Level 4	Level 5	Selection/configuration option Description	Standard
Offset			Output value=measurement value+offset The resolution of the offset value is independent of the selected "Resolution position" and is entered in mm or inch/100. The offset value is effective immediately following entry. If the preset value is activated, this has priority over the offset. Preset and offset are not offset against each other.	0 mm
Preset			The preset value is accepted by means of teach pulse. The teach pulse can be applied to a hardware input of the M 12 PWR connector. The hardware input must be appropriately configured. See also configuration of the I/Os.	0 mm
Free resolution value			The measurement value can be resolved in increments of 1/1000 within the 5 ... 50000 value range. If, e.g., a resolution of 0.875 mm per digit is required, the parameter is set to 875. In the activated interface, the measurement value display must also be set to "free resolution" ("SSI resolution" parameter).	1000
Error delay			ON / OFF Specifies whether, in the event of an error, the position value immediately outputs the value of the "Position value in the case of error" parameter or the last valid position value for the configured error delay time.	ON/100 ms
Position value in the case of error			Last valid value / zero Specifies which position value is output after the error delay time elapses.	Zero

I/O submenu

Table 8.5: I/O submenu

Level 3	Level 4	Level 5	Selection/configuration option Description	Standard
I/O 1	Port configuration		Input/Output Defines whether I/O 1 functions as an output or input.	Output
	Switching input	Function	No function/preset teach/laser ON/OFF	No function
		Activation	Low active/High active	Low active
	Switching output	Function	Pos. limit value 1 / Pos. limit value 2 / Velocity / Intensity (ATT) / Temp. (TMP) / Laser (LSR) / Plausibility (PLB) / Hardware (ERR) The individual functions are "ORed" on the selected switching output.	Plausibility (PLB), hardware (ERR)
Activation		Low active/High active	Low active	
I/O 2	Port configuration		Input/Output Defines whether I/O 2 functions as an output or input.	Output
	Switching input	Function	No function/preset teach/laser ON/OFF	No function
		Activation	Low active/High active	Low active
	Switching output	Function	Pos. limit value 1 / Pos. limit value 2 / Velocity / Intensity (ATT) / Temp. (TMP) / Laser (LSR) / Plausibility (PLB) / Hardware (ERR) The individual functions are "ORed" on the selected switching output.	Intensity (ATT), Temp. (TMP), Laser (LSR)
Activation		Low active/High active	Low active	
Limit values	Upper pos. limit 1	Activation	ON / OFF	OFF

Table 8.5: I/O submenu

Level 3	Level 4	Level 5	Selection/configuration option Description	Standard
		Limit value input	Value input in mm or inch/100	0
	Lower pos. limit 1	Activation	ON / OFF	OFF
		Limit value input	Value input in mm or inch/100	0
	Upper pos. limit 2	Activation	ON / OFF	OFF
		Limit value input	Value input in mm or inch/100	0
	Lower pos. limit 2	Activation	ON / OFF	OFF
		Limit value input	Value input in mm or inch/100	0

Other submenu

Table 8.6: Other submenu

Level 3	Level 4	Level 5	Selection/configuration option Description	Standard
Heating control			Standard (10°C ... 15°C)/Extended (30°C ... 35°) Defines a switch-on/switch-off range for the heating control. The extended switch-on/switch-off range for heating may provide relief in the event of condensation problems. There is no guarantee that no condensation will occur on the optics in the extended switch-on/switch-off range due to the limited heating capacity. This parameter is available as standard, but functions only for devices with integrated heating (AMS 348i SSI... H).	Standard
Display illumination			10 minutes/ON Display illumination is switched off after 10 minutes or, if the parameter is set to "ON", illumination is always on.	10 min.
Display contrast			Weak/Medium/Strong The display contrast may change at extreme temperature values. The contrast can subsequently be adapted using the three levels.	Medium
Service RS232	Baud rate		57.6kbit/s / 115.2kbit/s The service interface is only available to Leuze internally.	115.2kbit/s
	Format		8,e,1 / 8,n,1 The service interface is only available to Leuze internally.	8,n,1

8.3.3 Language selection menu

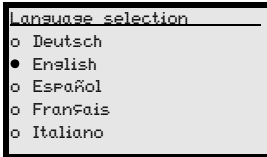

There are 5 display languages available:

- German
- English
- Spanish
- French
- Italian

The AMS 348i SSI is delivered from the factory with the display preset to English.



Notice!

When operating the AMS 348i SSI on the PROFINET, the language configured in the GSD file is used in the display.

To change the language, no password needs to be entered nor must password enabling be activated. The display language is a passive operational control and is, thus, not a function parameter, per se.

8.3.4 Service menu

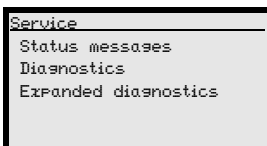

A more detailed description of the individual functions can be found in chapter 11.

8.4 Operation

Described here is an operating process using parameter enabling as an example.

Parameter enabling

During normal operation parameters can only be viewed. If parameters are to be changed, the ON menu item in the Parameter → Parameter handling → Parameter enable menu must be activated. To do this, proceed as follows:

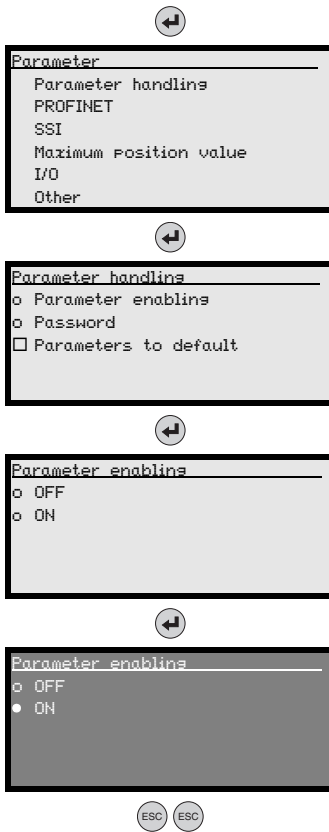

In the main menu, press the enter button to enter the Parameter menu.

Use the buttons to select the Parameter handling menu item.

Press the enter button to enter the Parameter handling menu.

In the Parameter handling menu, use the buttons to select the Parameter enabling menu item.

Press the enter button to enter the Parameter enabling menu.

In the Parameter enabling menu, use the buttons to select the ON menu item.

Press the enter button to switch on parameter enabling.

The PWR LED illuminates orange; the display is inverted. You can now set the individual parameters on the display.

Press the ESC button twice to return to the Parameter menu.



Viewing and editing parameters

As long as parameter enabling is activated, the entire AMS 348i SSI display is inverted.

As long as parameter enabling is activated, communication between control and AMS 348i SSI is interrupted. The continued networking via BUS OUT is retained.

Attention!

The AMS 348i SSI is deactivated on the PROFINET if parameter enabling is activated via the display. The device is reactivated on the PROFINET after parameter enabling is exited.

**Notice!**

In the PROFINET network, configuration is performed exclusively via the PROFINET Controller.

Parameters set via the display when operating the AMS 348i SSI on the PROFINET are overwritten by the parameters set in the GSD modules. For GSD modules which are not actively used on the PROFINET, the default settings of the AMS 348i SSI, see "Overview of the GSD modules" on page 69. Thus, the PROFINET presets values to all parameters.

**Notice!**

If a password was stored, parameter enabling is not possible until this password is entered, see "Password for parameter enabling" below.

Password for parameter enabling**Notice!**

The **master password 2301** can enable the AMS 348i SSI at any time.

9 PROFINET interface

9.1 General information on PROFINET

The AMS 348*f* is designed as a PROFINET-RT (Real Time) device (acc. to IEEE 802.3). It supports a transmission rate of up to 100 Mbit/s (100Base TX/FX), full duplex, as well as auto-negotiation and auto-crossover.

The functionality of the device is defined via parameter sets which are organized in modules. The modules form part of the GSD file.

Each AMS 348*f* has a unique MAC-ID which is described on the name plate. This is linked to an IP address during the course of configuration. In the Simatic Manager for creation of PROFINET networks, the IP address is also linked to a freely selectable device name which may only exist once in the network (see chapter 9.8.4.3 "Step 3 – Hardware configuration of the S7 PLC: Configuration").

9.2 Identification & Maintenance Functions

The AMS 348*f* supports the base record I&M0:

Contents	Index	Data type	Description	Value
Header	0	10 bytes	Manufacturer specific	-
MANUFACTURER_ID	10	UNSIGNED16	Leuze manufacturer ID	338
ORDER_ID	12	ASCII string 20 bytes	Leuze order no.	-
SERIAL_NUMBER	32	ASCII string 16 bytes	Unique device serial number	Device-dependent
HARDWARE_REVISION	48	UNSIGNED16	Hardware revision number, e.g., "0...65535"	Device-dependent
SOFTWARE_REVISION	50	1xCHAR, 3xUNSIGNED8	Software version number, e.g. V130 correspond to "V1.3.0"	Device-dependent
REVISION_COUNTER	54	UNSIGNED16	Is incremented when updating individual modules. This function is not supported.	0
PROFILE_ID	56	UNSIGNED16	PROFINET application profile number	0xF600 (Generic Device)
PROFILE_SPECIFIC_TYPE	58	UNSIGNED16	Info about subchannels and submodules. Not relevant	0x01,0x01
IM_VERSION	60	2xUNSIGNED8	Implemented I&M version V 1.1	0x01,0x01
IM_SUPPORTED	62	Bit[16]	Optional I&M records available	0

Table 9.1: Base record I&M0

9.3 PROFINET – Star topology

The AMS 348*f* can be operated as a single device (standalone) with an individual device name in a star topology. The PLC must communicate this device name to the participant during the "device naming".

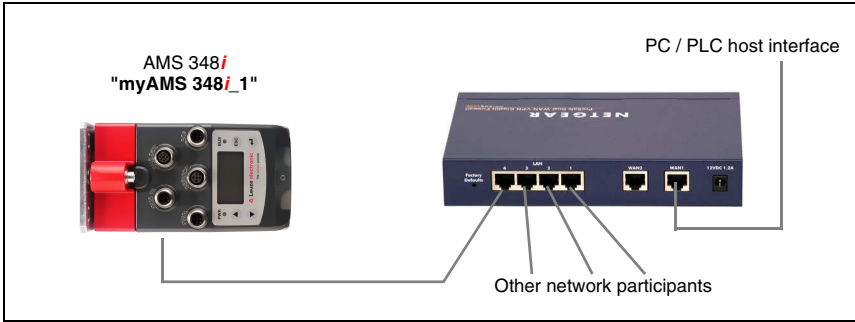

Figure 9.1: PROFINET in a star topology

9.4 PROFINET – Linear topology

The innovative further development of the AMS 348*i* with integrated switch functionality offers the option of connecting multiple laser measurement systems of type AMS 348*i* to one another without direct connection to a switch. In addition to the classic "star topology", a "linear topology" is thus also possible.

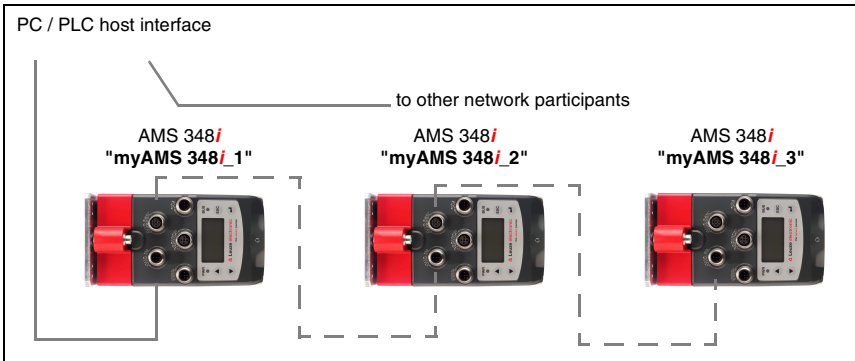

Figure 9.2: PROFINET in a linear topology

The maximum length of a segment (from the host to the furthest participant) is limited to 100m.

9.5 PROFINET – General information on wiring

A Cat. 5 Ethernet cable should be used for wiring.

For the connection technology transition from M12 to RJ45, a "KDS ET M12 / RJ 45 W - 4P" adapter is available that lets you connect standard network cables.

If no standard network cables are to be used (e.g. due to lacking IP... degree of protection), you can use the "KB ET - ... - SA" ready-made cable on the AMS 348*i*, see table 12.4.5 "Accessory ready-made cables for PROFINET" on page 114.

The individual AMS 348*i* devices in a linear topology are connected with the "KB ET - ... - SSA" cable, see table 12.4.5 "Accessory ready-made cables for PROFINET" on page 114.

For unavailable cable lengths, you can configure your cables yourself. For this purpose, Leuze electronic offers a D-coded M12 round plug connector for Bus IN and Bus Out, see table 12.4.3 "Accessory M12 connector" on page 112.

9.6 PROFINET – Cable lengths and shielding

↳ *Observe the following maximum cable lengths and shielding types:*

Connection	Interface	Max. cable length	Shielding
AMS – host	PROFINET-RT	100m	Absolutely required
Network from the first AMS to the last AMS	PROFINET-RT	The maximum segment length must not exceed 100m for 100Base-TX Twisted Pair (min. cat. 5)	Absolutely required

Table 9.2: Cable lengths and shielding

9.7 PROFINET - Electrical connection

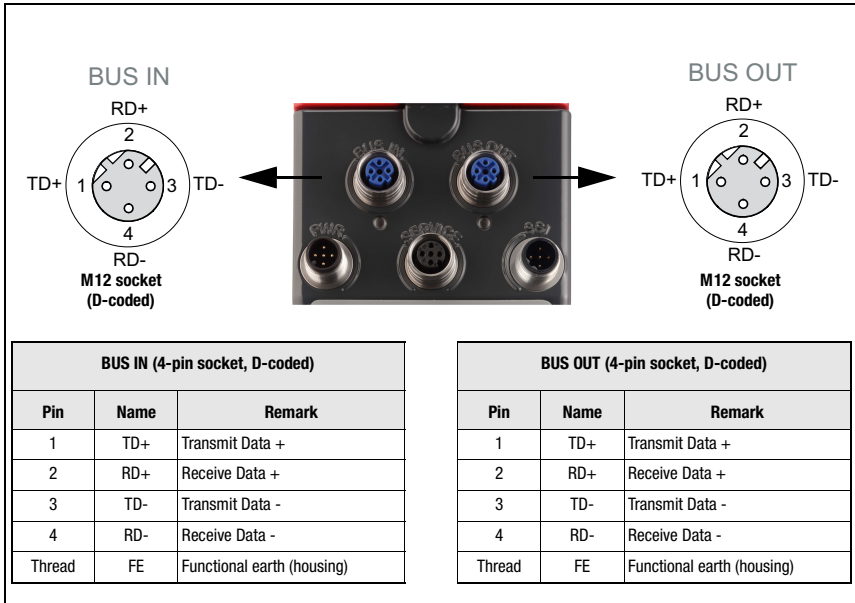

Figure 9.3: PROFINET - Electrical connection



Notice!

For contacting **BUS IN** and **BUS OUT**, we recommend our ready-made PROFINET cable (see chapter 12.4.5 "Accessory ready-made cables for PROFINET").

To set up a PROFINET network with other participants with linear topology, the AMS 348*i* makes available another PROFINET-RT interface. The use of this interface drastically reduces the cabling requirements, as only the first AMS 348*i* requires a direct connection to the switch, via which it can communicate with the host. All other AMS 348*i* can be connected in series to the first AMS 348*i*, see figure 9.2.

✎ For the connection of two AMS 348*i*, the "KB ET - ... - SSA" ready-made cables are preferred, see table 12.4.5 "Accessory ready-made cables for PROFINET" on page 114.

If you use user-configurable cables, note the following:



Notice!

The entire interconnection cable must be shielded. The shielding connection must be at the same potential on both ends of the data line. This prevents potential compensating currents over the shield and possible interference coupling by compensating currents. The signal lines must be stranded in pairs.
Use CAT 5 cable for the connection.

**Notice!**

For the AMS 348*i* as standalone device or as the last participant in a linear topology, termination on the BUS OUT socket is not mandatory!

9.8 PROFINET – Commissioning and configuration

9.8.1 PROFINET implementation of the AMS 348*i*

PROFINET communication profile

The **communication profile** defines how participants serially transmit their data via the transmission medium.

The **PROFINET** communication profile is designed for efficient data exchange on the field level. The data exchange with the devices is mainly **cyclical**. For the configuration, operation, monitoring and alarm handling, however, **acyclic** communication services are also used.

Depending on the communication requirements, PROFINET offers suitable protocols and transfer methods:

- **Real Time communication (RT)** via prioritized Ethernet frames for
 - Cyclical process data (I/O data stored in the I/O area of the control)
 - Alarms
 - Clock synchronization
 - Neighborhood information
 - Address assignment/address resolution via DCP.

- **TCP/UDP/IP communication** via standard Ethernet TCP/UDP/IP frames for
 - Establishing communication and
 - Acyclic data exchange, and also for the transfer of various information types such as:
 - Parameters for the configuration of the modules during the establishment of the communication
 - I&M data (Identification & Maintenance functions)
 - Reading diagnostic information
 - Reading I/O data
 - Writing device data

Conformance Classes

PROFINET devices are categorized into conformance classes to simplify the evaluation and selection of the devices for the users. The AMS 348*i* can use an existing Ethernet network infrastructure and corresponds to Conformance Class B (CC-B). Thus, it supports the following features:

- Cyclical RT communication
- Acyclic TCP/IP communication
- Alarms/diagnostics
- Automatic address assignment
- I&M 0 functionality
- Neighborhood detection basic functionality
- FAST Ethernet 100 Base-TX
- Convenient device exchange without engineering tools
- SNMP support

9.8.2 Measures to be performed prior to the initial commissioning

- ↳ *Before commissioning, familiarize yourself with the operation and configuration of the AMS 348*i*.*
- ↳ *Before connecting the supply voltage, recheck all connections and ensure that they have been properly made.*



Figure 9.4: Connections of the AMS 348*i*

- ↳ *Check the applied voltage. It must be in the range between +18V ... 30VDC.*

Connecting functional earth FE

- ↳ *Ensure that the functional earth (FE) is connected correctly.*

Unimpaired operation is only guaranteed when the functional earth is connected properly. All electrical disturbances (EMC couplings) are discharged via the functional earth connection.

9.8.3 Starting the device

- ↳ Connect the supply voltage; the AMS 348*i* boots and the Status and measurement data main menu appears in the display:

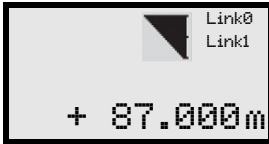

This section describes how the AMS 348*i* is configured in a Siemens Simatic S7 for PROFINET.

9.8.4 Configuration steps for a Siemens Simatic S7 control

The following steps are necessary for commissioning with a Siemens S7 control:

1. Preparing the control system (S7 PLC)
2. Installing the GSD file
3. Hardware configuration of the S7 PLC
4. Transfer of the PROFINET configuration to the IO Controller (S7 PLC)
5. Device naming
 - Configuration of the device name
 - Device naming
 - Assigning the device names to the configured IO devices(see figure 9.6)
 - Assignment of MAC address - IP address -individual device name (see figure 9.10)
6. Check device name

9.8.4.1 Step 1 – Preparing the control system (S7 PLC)

The first step involves the assignment of an IP address to the IO Controller (PLC - S7) and the preparation of the control for consistent data transmission.



Notice!

If an S7 control is used, you need to ensure that Simatic-Manager Version 5.4 + service pack 5 (V5.4+SP5) or higher is used.

9.8.4.2 Step 2 – Installation of the GSD file

For the subsequent configuration of the IO devices, e.g., AMS 348*i*, the corresponding GSD file must be loaded first.

General information on the GSD file

The term GSD stands for the textual description of a PROFINET device model.

For the description of the more complex PROFINET device model, the XML-based GSDML (Generic Station Description Markup Language) was introduced.

In the following, the terms "GSD" or "GSD file" always refer to the GSDML-based format.

The GSDML file can support an arbitrary number of languages in one file. Every GSDML file contains a version of the AMS 348*i* device model. This is also reflected in the file name.

File name structure

The file name of the GSD file is constructed according to the following rule:

GSDML-[GSDML schema version]-Leuze-AMS348i-[date].xml

Explanation:

- GSDML schema version:
Version identifier of the GSDML schema version used, e.g., V2.2.
- Date:
Release date of the GSD file in the format `yyyymmdd`.
This date doubles as the version identifier of the file.

Example:

GSDML-V2.2-Leuze-AMS348i-20090503.xml

You can find the GSD file at www.leuze.com

All data in modules required for operating the **AMS 348i** is described in this file. These are input and output data and device parameters for the functioning of the **AMS 348i** and the definition of the control and status bits.

If parameters are changed, e.g., in the project tool, these changes are stored on the PLC side in the project, not in the GSD file. The GSD file is a certified and integral part of the device and must not be changed manually. The file is not changed by the system either.

The functionality of the **AMS 348i** is defined via GSD parameter sets. The parameters and their functions are structured in the GSD file using module. A user-specific configuration tool is used during PLC program creation to integrate the required modules and configure them appropriately for their respective use. During operation of the **AMS 348i** on the PROFINET, all parameters are set to default values. If these parameters are not changed by the user, the device functions with the default settings delivered by Leuze electronic.

For the default settings of the **AMS 348i**, please refer to the following module descriptions.

9.8.4.3 Step 3 – Hardware configuration of the S7 PLC: Configuration

The AMS 348*i* is activated by "Drag and Drop" and receives the IP address and a unique device name.

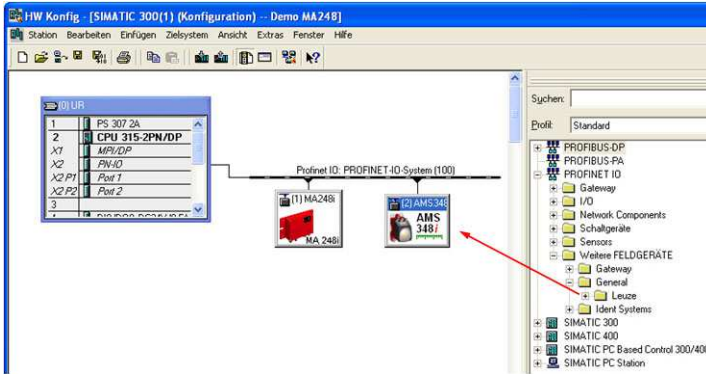

Figure 9.5: Insert AMS 348*i* into the project

Double-clicking the participant opens the properties window. Here you can assign a unique device name that exists only once in the network. If desired, an IP address can be assigned manually (not mandatory). As the assignment of the device name takes place in offline mode, unique assignment must take place between the MAC ID of the installed device and the device name assigned in offline mode during the further course of configuration, see also step 5.

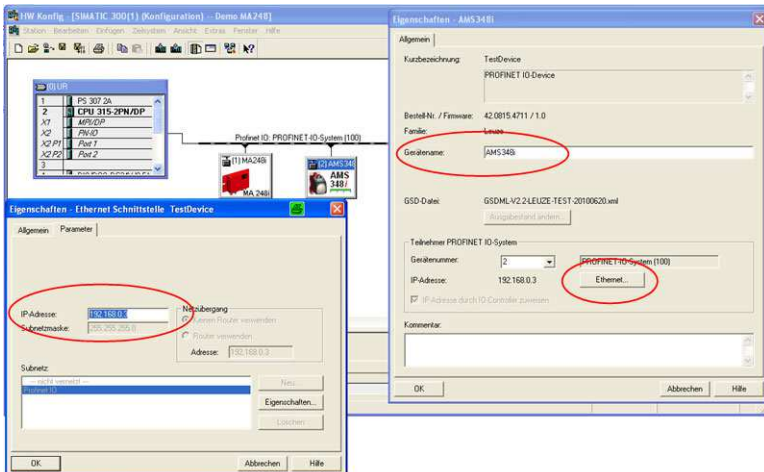

Figure 9.6: Assign unique device name in the properties window

9.8.4.4 Step 4 – Transfer of the configuration to the IO Controller (S7 PLC)

After the correct transfer to the IO Controller (S7 PLC), the PLC automatically carries out the following activities:

- Check device names
- Assignment of the IP addresses that were configured in the HW Config to the IO devices
- Establishment of a connection between the IO Controller and configured IO devices
- Cyclical data exchange



Notice!

Participants without assigned device names cannot yet be addressed at this point in time!

9.8.4.5 Step 5 – Configuration of the device name - naming the device

Each AMS 348*i* has an individual and unique MAC ID. The MAC ID can be found on the name plate of the device.

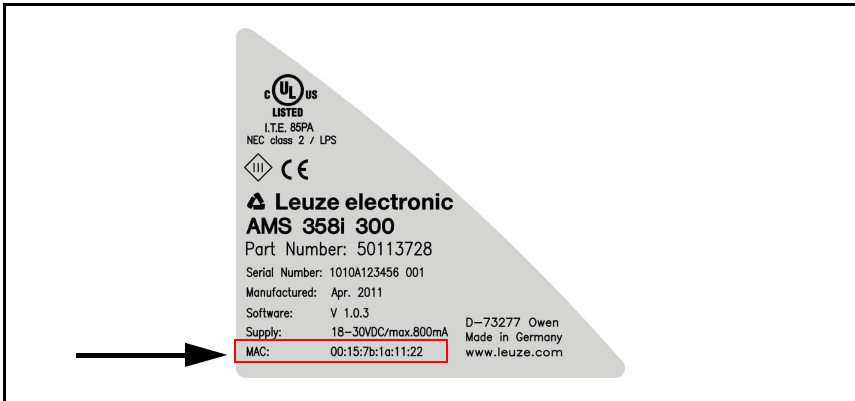
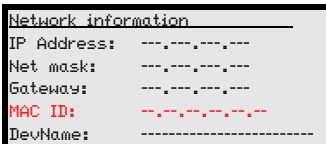

Figure 9.7: MAC ID on the name plate



Notice!

*This figure is for illustration only and does not correspond in all details to the AMS 348*i*. The MAC ID in particular must be read separately from each individual device. The MAC ID is also shown in the display of the AMS 348*i*.*



After successful naming, the device name can be read here under DEVName.



Notice!

All AMS 348i participants in a PROFINET network must be located in the same subnet!

Device naming

The so-called "device naming" under PROFINET is understood as the unique assignment of the device name from the PLC program generation (see step 3) to the PROFINET participant mounted in the system. The device name is linked to the MAC ID of the mounted PROFINET participant.

It is mandatory that the device name corresponds to the device name assigned in hardware configuration (step 3).

- ↳ Under "Target systems", select item "Edit Ethernet participant".
- ↳ Click "Search" to scan the connected PROFINET network for MAC addresses.

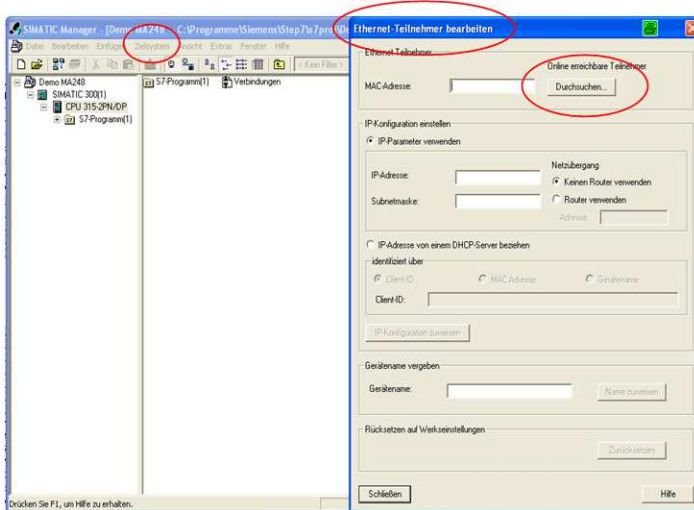

Figure 9.8: Scan the PROFINET network for connected devices (MAC addresses)

➤ Mark the desired MAC address to which you wish to assign a device name.

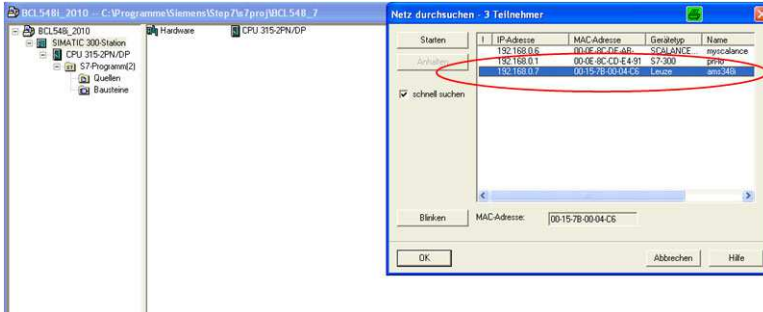

Figure 9.9: Select desired device (MAC address)



Notice!

The Simatic Manager offers the possibility of having the found and marked participant (marking of the MAC ID in the Simatic Manager) flash/wave. The mounting location of the participant in the system can then be uniquely assigned to the MAC ID. The marked MAC ID "waves".

During flashing/waving, the Power LED and BUS LED of the AMS 348i flash orange.

The found MAC ID is "linked" to the device name assigned in the hardware configurator. Please be sure to pay attention that the names are the same and that the installed device is correctly assigned to the hardware configuration. This is particularly important if identical devices are installed several times in the same system.



Figure 9.10: Linking of the device name to the MAC ID of the participant

The same configuration mask can be used, if necessary, to manually assign an IP address. Alternatively, the IP address can be assigned via a DHCP server.

9.8.4.6 Neighborhood detection

Neighborhood detection in Step 7 takes place using a port assignment:

- BUS IN corresponds to port 1 (X1 P1).
- BUS OUT corresponds to port 2 (X1 P2).

9.9 PROFINET GSD file

9.9.1 General information on the GSD file

The functionality of the AMS 348*i* is defined via an XML-based GSD file. The GSD file is the same for all AMS 348*i* and forms a mandatory part of the device. The GSD file has a modular architecture and contains all the functions of the AMS 348*i* in modules.

The AMS 348*i* offers 17 different modules. Each of these modules can only be activated once per AMS.

The AMS 348*i* checks its max. permissible number of modules. The control also reports an error if the input and output data across all modules exceed a total length of 1024 bytes.

The specific limits of the individual modules of the AMS 348*i* are stored in the module description and in the GSD file.



Notice!

*You can find the current GSD file for the AMS 348*i* on our homepage under: www.leuze.com.*

The participant (here AMS 348*i*) is configured via the GSD file with a user-specific configuration tool such as the Siemens Simatic Manager.

The exchange of data and the configuration of parameters is organized by means of the GSD file.

All the parameters of the AMS 348*i* are preset default values. These can be altered, depending on the application. The user activates only the modules from the GSD file whose parameters should be changed or whose input/output data are to be read.

For this purpose, the corresponding module from the GSD file is activated and configured or prepared for control and reading of inputs and outputs.

All parameters and accesses to the AMS 348*i* are thus stored in the control. If necessary, the configuration is written to the AMS according to predefined control criteria.



Notice!

*Parameters can be changed via the display on the AMS 348*i* for test purposes. As soon as parameter enabling is activated on the display, the AMS 348*i* is deactivated on the PROFINET. All the parameters set via the GSD file initially remain active in the AMS 348*i*. Parameter changes can now be made via the display for test purposes. If parameter enabling is deactivated via the display, only the parameters entered in the PROFINET modules and the PROFINET default settings are in effect.*

Parameter changes made via the display are no longer in effect on the PROFINET!



Attention!

The laser measurement system does not permanently store parameters changed via the PROFINET. Following power OFF/ON the currently configured parameters are downloaded by the PROFINET master. If the PROFINET master is no longer available after power OFF/ON, the default parameters are valid.



Notice!

*All input and output modules described in this documentation are described **from the controller's perspective**:*

Described inputs (I) are inputs of the control.

Described outputs (O) are outputs of the control.

Described parameters (P) are parameters of the GSD file in the control.

9.9.2 Overview of the GSD modules

Module	Module name	Module contents (P) = Parameter, (O) = Output, (I) = Input
M1 page 72	Maximum position value	(I) Position value
		(P) Sign
		(P) Unit
		(P) Resolution
		(P) Count direction
		(P) Offset
M2 page 74	Static preset	(P) Preset value
		(O) Preset teach
		(O) Preset reset
M3 page 75	Dynamic preset	(O) Preset value
		(O) Preset teach
		(O) Preset reset
M4 page 76	I/O 1	(P) Output or input defined
		(P) Level/edge input/output
		(P) Function for output wiring
		(P) Function for input wiring
		(I) Signal level input/output
		(O) Output activated
M5 page 78	I/O 2	(P) Output or input defined
		(P) Level/edge input/output
		(P) Function for output wiring
		(P) Function for input wiring
		(I) Signal level input/output
		(O) Output activated
M6 page 80	Status and control	(I) Diagnosis and status of AMS 348/SSI (O) Laser control ON/OFF
M7 page 82	Position limit value 1	(P) Upper and lower position limit value
M8 page 83	Position limit value 2	(P) Upper and lower position limit value
M9 page 84	Error handling procedures	(P) Position value in case of error
		(P) Position error message delay ON/OFF
		(P) Position error message delay
		(P) Velocity value in case of error
		(P) Velocity error message delay ON/OFF
		(P) Velocity error message delay
M10 page 85	Velocity	(I) Velocity value
		(P) Velocity value resolution
		(P) Velocity integration time
M11 page 87	Velocity Limit value 1	(P) Monitoring for over/under values
		(P) Monitoring direction dependent yes/no
		(P) Velocity limit value 1
		(P) Hysteresis of velocity limit value
		(P) Start of velocity monitoring range
		(P) End of velocity monitoring range

M12 page 89	Velocity Limit value 2	(P) Monitoring for over/under values
		(P) Monitoring direction dependent yes/no
		(P) Velocity limit value 2
		(P) Hysteresis of velocity limit value
		(P) Start of velocity monitoring range
		(P) End of velocity monitoring range
M13 page 90	Velocity Limit value 3	(P) Monitoring for over/under values
		(P) Monitoring direction dependent yes/no
		(P) Velocity limit value 3
		(P) Hysteresis of velocity limit value
		(P) Start of velocity monitoring range
		(P) End of velocity monitoring range
M14 page 91	Velocity Limit value 4	(P) Monitoring for over/under values
		(P) Monitoring direction dependent yes/no
		(P) Velocity limit value 4
		(P) Hysteresis of velocity limit value
		(P) Start of velocity monitoring range
		(P) End of velocity monitoring range
M15 page 92	Velocity Limit value Dynamic	(O) Release/lock limit value control
		(P) Monitoring for over/under values
		(P) Monitoring direction dependent yes/no
		(O) Dynamic velocity limit value
		(O) Hysteresis of velocity limit value
		(O) Start of velocity monitoring range
(O) End of velocity monitoring range		
M16 page 93	Velocity status	(I) Status of velocity monitoring
M17 page 95	SSI interface	(P) Gray/Binary coding
		(P) Number of data bits
		(P) Resolution
		(P) Update rate
		(P) Function of the error bit
M18 page 98	Other	(P) Display language selection
		(P) Display illumination
		(P) Display contrast
		(P) Activate/inhibit password
		(P) Password
		(P) Heating control
M19	–	–
M20 page 99	Free resolution	(P) Position resolution
		(P) Velocity resolution

Table 9.3: Overview of the GSD modules

9.9.3 Detail description of the modules

**Notice!**

In the following detailed descriptions of the modules you will find in the last column of the tables **cross references (CR) to parameters and input/output data of other modules** which are directly related to the described parameter. These cross references must absolutely be observed during configuration.

The individual **modules** are numbered from **1 ... 20**.

The **parameters and input/output data** within a module are from **a ... z**.

Example:

The **a preset** parameter in module 2 becomes active only when the preset teach occurs via module 2.b, 4.d or 5.d.

9.9.3.1 Module 1: Position value

PROFINET module identifier

Module-ID 1001
 Submodule-ID 1

Description

Outputs the current position value.

The parameters for sign, unit, resolution, count direction and offset remain adjustable.

Parameter

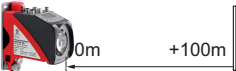
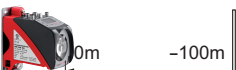
Parameter	Description	Rel. addr.	Data type	Value range	Default	Unit		CR to module
						Metr.	Inch	
a Sign	Output mode of the sign. Sign affects position and velocity output	0.0	Bit	0: two's complement 1: sign + quantity	0	-		-
b Measurement unit	Selection of the measurement unit ¹⁾ . The parameter applies to all values with measurement units. The parameter applies to all interfaces.	0.1	Bit	0: metric 1: inch (in)	0	-		-
c Resolution	Resolution of the position value. Affects only the PROFINET output. The resolution does not apply to: - Static preset - Dynamic preset - Offset	0.2 ... 0.4	Bit	001 = 1: 0.001 010 = 2: 0.01 011 = 3: 0.1 100 = 4: 1 101 = 5: 10 110 = 6: free resolution	4	mm	in/100	20a
d Count direction	Counting direction positive:  Counting direction negative:  The parameter applies to all interfaces. The count direction changes the sign during velocity measurement.	0.5	Bit	0: positive 1: negative	0	-		-
e Offset	Output value = measurement value+offset. The parameter applies to all interfaces. Attention: If the preset is activated, it has priority over the offset. Preset and offset are not offset against each other. The resolution of the offset value is independent of the resolution selected in module 1. The entered offset applies immediately without any further release.	1 - 4	sign 32 bit	-999999 ... +999999	0	mm	in/100	-

Parameter length: 6 bytes

1) see following notice!



Notice!

If the **unit of measurement is changed from metric to inch** (or vice versa), **previously entered numerical values** (e.g. for offset, preset, limit values etc.) **are not automatically converted**. This must be performed manually!

Example:

Preset = 10000mm -> Change from metric to inch -> Preset = 10000 inch/100

Input data

Input data	Description	Rel. addr.	Data type	Value	Default	Unit		CR to module
						Metr.	Inch	
f Position value	Output of the current position.	0	sign 32 bit	-999999 ... +999999	-	scaled		9a
Input data length: 4 bytes consistently								

Output data

None

9.9.3.2 Module 2: Static preset

PROFINET module identifier

Module-ID 1002
 Submodule-ID 1

Description

With this module, a preset value can be specified. The specified preset value becomes active in the position in which preset teaching is performed.



Notice!

In the event of a device change the preset value is retained in the PROFINET manager. The activation of the preset value (preset teach) at the intended position must, however, be performed again.

Parameter

Parameter	Description	Rel. addr.	Data type	Value	Default	Unit		CR to module
						Metr.	Inch	
a Preset	Preset value. The value is accepted during a corresponding teach event (see output data). The resolution of the preset value is independent of the resolution selected in module 1.	0	sign 32 bit	-999999 ... +999999	0	mm	in/100	2b 4d 5d
Parameter length: 4 bytes								

Input data

None

Output data

Output data	Description	Rel. addr.	Data type	Value	Default	Unit		CR to module
						Metr.	Inch	
b Preset teach	Read in the preset value.	0.0	Bit	0→1 Preset teach	–	–	–	4d 5d
c Preset reset	Preset value is deactivated.	0.1	Bit	0→1 Preset teach	–	–	–	4d 5d
Output data length: 1 byte								

9.9.3.3 Module 3: Dynamic preset

PROFINET module identifier

Module-ID 1003
 Submodule-ID 1

Description

With this module, a preset value can be specified. The specified preset value becomes active in the position in which preset teaching is performed. The preset value can be adjusted within the control to meet plant requirements without intervening in the static parameter structure.

Parameter

None

Input data

None

Output data

Output data	Description	Rel. addr.	Data type	Value	Default	Unit		CR to module
						Metr.	Inch	
a Preset teach	Read in the preset value.	0.0	Bit	0→1 Preset teach	–	–		4d 5d
b Preset reset	Preset value is deactivated. Output value=measurement value+off-set	0.1	Bit	0→1 Preset teach	–	–		4d 5d
c Preset	The value is accepted during a corresponding teach event. The resolution of the preset value is independent of the resolution selected in module 1.	1	sign 32 bit	-999999 ... +999999	–	mm	in/100	3a 4d 5d
Output data length: 5 bytes								

9.9.3.4 Module 4: I/O 1 Input/Output

PROFINET module identifier

Module-ID 1004
 Submodule-ID 1

Description

The module defines the mode of operation of the digital input/output I/O 1.

Parameter

Parameter	Description	Rel. addr.	Data type	Value	Default	Unit		CR to module
						Metr.	Inch	
a Function	The parameter defines whether I/O 1 functions as an input or as an output.	0.0	Bit	0: Input 1: Output	1	–		4cd
b Activation	The parameter defines the level of the output when the "output" event is received. If I/O 1 is configured as an input, the response is edge-controlled.	0.1	Bit	0: Low 1-0 transition 1: High 0-1 transition	0	–		–
c Output	The parameter defines which event triggers activation of the output. The individual functions are OR -linked to one another.					–		4a
	Position limit value 1 If the position value lies outside of configured limit range 1, the output is set.	1.0	Bit	0 = OFF 1 = ON	0	–		
	Position limit value 2 If the position value lies outside of configured limit range 2, the output is set.	1.1	Bit	0 = OFF 1 = ON	0	–		
	Velocity limit value If the velocity value lies outside of the configured values, the output is set. Monitoring from modules 11 to 15 is OR-linked.	1.2	Bit	0 = OFF 1 = ON	0	–		
	Intensity (ATT) If the intensity of the received signal is less than the warning threshold, the output is set.	1.3	Bit	0 = OFF 1 = ON	0	–		
	Temperature (TMP) If the internal device temperature exceeds the set limit value, the output is set.	1.4	Bit	0 = OFF 1 = ON	0	–		
	Laser (LSR) Laser preailure message.	1.5	Bit	0 = OFF 1 = ON	0	–		
	Plausibility (PLB) If implausible measurement values are diagnosed, the output is set.	1.6	Bit	0 = OFF 1 = ON	1	–		

c	Hardware (ERR) If a hardware error is diagnosed, the output is set.	1.7	Bit	0 = OFF 1 = ON	1	–	4a
	Pseudodynamic output If bit 0.0 is set in the output data, the output is set.	2.0	Bit	0 = OFF 1 = ON	0	–	
d	Preset The HW input is used as preset teach input (valid for static or dynamic preset).	3.0 ...	unsign 8 bit	000 = HW input no function 001 = HW input as preset teach function 010 = HW input as laser OFF function	000	–	4a
	Laser The HW input is used as laser OFF.	3.2					
Parameter length: 4 bytes							



Notice!

Behaviour of the AMS 348i SSI on Laser ON/OFF:

If the laser light spot is positioned on the reflector when the laser diode is switched on, the AMS 348i SSI returns valid measurement values after approx. 330ms.

If the laser light spot is **not** positioned on the reflector when the laser diode is switched on, the AMS 348i SSI cannot calculate any distance values. If the laser beam hits the reflector at a later point in time while switched-on, the AMS 348i SSI 200 returns valid measurement values after the following time span:

$t = (\text{measurement distance} / 20m) \text{ sec.}$

Example: Corridor change of a high-bay storage device during which the laser diode is not switched off while traveling around curves.
Measurement distance 100m -> t = 5sec., measurement distance 200m -> t = 10sec.

Input data

Input data	Description	Rel. addr.	Data type	Value	Default	Unit		CR to module
						Metr.	Inch	
e	Signal state of the input or output.	0.0	Bit	0: Input/Output at signal level not active	–	–	–	–
State				1: Input/Output at signal level active				
Input data length: 1 byte								

Output data

Output data	Description	Rel. addr.	Data type	Value	Default	Unit		CR to module
						Metr.	Inch	
f	The output can be activated/deactivated with this bit. The corresponding release is performed in module 4, output parameter bit 2.0.	0.0	Bit	0: Output at signal level not active	–	–	–	4c
State				1: Output at signal level active				
Output data length: 1 byte								

9.9.3.5 Module 5: I/O 2 Input/Output

PROFINET module identifier

Module-ID 1005
 Submodule-ID 1

Description

The module defines the mode of operation of the digital input/output I/O 2.

Parameter

Parameter	Description	Rel. addr.	Data type	Value	Default	Unit		CR to module
						Metr.	Inch	
a Function	The parameter defines whether I/O 2 functions as an input or as an output.	0.0	Bit	0: Input 1: Output	1	–		5cd
b Activation	The parameter defines the level of the output when the "output" event is received. If I/O 2 is configured as an input, the response is edge-controlled.	0.1	Bit	0: Low 1-0 transition 1: High 0-1 transition	0	–		–
c Output	The parameter defines which event triggers activation of the output. The individual functions are OR -linked to one another.					–		5a
	Position limit value 1 If the position value lies outside of configured limit range 1, the output is set.	1.0	Bit	0 = OFF 1 = ON	0	–		
	Position limit value 2 If the position value lies outside of configured limit range 2, the output is set.	1.1	Bit	0 = OFF 1 = ON	0	–		
	Velocity limit value If the velocity value lies outside of the configured values, the output is set. Monitoring from modules 11 to 15 is OR-linked.	1.2	Bit	0 = OFF 1 = ON	0	–		
	Intensity (ATT) If the intensity of the received signal is less than the warning threshold, the output is set.	1.3	Bit	0 = OFF 1 = ON	1	–		
	Temperature (TMP) If the internal device temperature exceeds the set limit value, the output is set.	1.4	Bit	0 = OFF 1 = ON	1	–		
	Laser (LSR) Laser prefailure message.	1.5	Bit	0 = OFF 1 = ON	1	–		
	Plausibility (PLB) If implausible measurement values are diagnosed, the output is set.	1.6	Bit	0 = OFF 1 = ON	0	–		

c Output	Hardware (ERR) If a hardware error is diagnosed, the output is set.	1.7	Bit	0 = OFF 1 = ON	0	–	5a
	Pseudodynamic output If bit 0.0 is set in the output data, the output is set.	2.1	Bit	0 = OFF 1 = ON	0	–	
d Input	Preset The HW input is used as preset teach input (valid for static or dynamic preset). Laser The HW input is used as laser OFF.	3.0 ... 3.2	unsign 8 bit	000 = HW input no function 001 = HW input as preset teach function 010 = HW input as laser OFF function	000	–	5a
Parameter length: 4 bytes							



Notice!

Behaviour of the AMS 348i SSI on Laser ON/OFF:

If the laser light spot is positioned on the reflector when the laser diode is switched on, the AMS 348i SSI returns valid measurement values after approx. 330ms.

If the laser light spot is **not** positioned on the reflector when the laser diode is switched on, the AMS 348i SSI cannot calculate any distance values. If the laser beam hits the reflector at a later point in time while switched-on, the AMS 348i SSI returns valid measurement values after the following time span:

$$t = (\text{measurement distance} / 20m) \text{ sec.}$$

Example: Corridor change of a high-bay storage device during which the laser diode is not switched off while traveling around curves.
Measurement distance 100m -> t = 5sec., measurement distance 200m -> t = 10sec.

Input data

Input data	Description	Rel. addr.	Data type	Value	Default	Unit		CR to module
						Metr.	Inch	
e State	Signal state of the input or output.	0.0	Bit	0: Input/Output at signal level not active 1: Input/Output at signal level active	–	–	–	–
Input data length: 1 byte								

Output data

Output data	Description	Rel. addr.	Data type	Value	Default	Unit		CR to module
						Metr.	Inch	
f State	The output can be activated/deactivated with this bit. The corresponding release is performed in module 5, output parameter bit 2.1.	0.0	Bit	0: Output at signal level not active 1: Output at signal level active	–	–	–	5c
Output data length: 1 byte								

9.9.3.6 Module 6: Status and control

PROFINET module identifier

Module-ID 1006
 Submodule-ID 1

Description

The module signals various status information of the AMS 348*f*. The laser can be controlled via the master's output data.

Parameter

None

Input data

Input data	Description	Rel. addr.	Data type	Value	Default	Unit		CR to module
						Metr.	Inch	
a Laser status	Signals the laser status.	1.0	Bit	0: Laser ON 1: Laser OFF	–	–	–	–
b Preset status	Status of the preset value.	1.1	Bit	0: Preset not active 1: Preset active	–	–	–	–
c Preset teach	This bit toggles on each teach event of a preset value.	1.2	Bit	0 or 1	–	–	–	–
d Reserved		1.3	Bit		–	–	–	–
e Intensity (ATT)	If the intensity of the received signal is less than the warning threshold, the status bit is set.	1.4	Bit	0: OK 1: Warning	–	–	–	–
f Temperature (TMP)	If the internal device temperature exceeds or drops below the set limit value, the status bit is set.	1.5	Bit	0: OK 1: Temperature above/below limit	–	–	–	–
g Laser (LSR)	Laser prefailure message.	1.6	Bit	0: OK 1: Laser warning	–	–	–	–
h Plausibility (PLB)	If implausible measurement values are diagnosed, the status bit is set.	1.7	Bit	0: OK 1: Implausible measurement value	–	–	–	–
i Hardware (ERR)	If a hardware error is diagnosed, the status bit is set.	0.0	Bit	0: OK 1: Hardware error	–	–	–	–
j Lower position limit value 1	Signals that the value is less than lower limit value 1.	0.4	Bit	0: OK 1: Value less than limit	–	–	–	–
k Upper position limit value 1	Signals that the value is greater than upper limit value 1.	0.5	Bit	0: OK 1: Value greater than limit	–	–	–	–

l Lower position limit value 2	Signals that the value is less than lower limit value 2.	0.6	Bit	0: OK 1: Value less than limit	-	-	-
m Upper position limit value 2	Signals that the value is greater than upper limit value 2.	0.7	Bit	0: OK 1: Value greater than limit	-	-	-

Input data length: 2 bytes

Output data

Output data	Description	Rel. addr.	Data type	Value	Default	Unit		CR to module
						Metr.	Inch	
n Laser	Laser control.	0.0	Bit	0: Laser ON 1: Laser OFF	-	-	-	-

Output data length: 2 bytes

9.9.3.7 Module 7: Position limit value range 1

PROFINET module identifier

Module-ID 1007
Submodule-ID 1

Description

The position limit value range 1 parameter defines a distance range with lower and upper limits. If the measured value lies outside of the configured range, the corresponding bit is set in module 6 or, if configured, an output is set.

Parameter

Parameter	Description	Rel. addr.	Data type	Value	Default	Unit		CR to module
						Met.	Inch	
a Lower pos. limit 1	Specifies the lower position limit.	0...3	sign 32 bit	-999999 ... +999999	0	mm	in/100	–
b Upper pos. limit 1	Specifies the upper position limit.	4...7	sign 32 bit	-999999 ... +999999	0	mm	in/100	–
Parameter length: 8 bytes								

Input data

None

Output data

None

9.9.3.8 Module 8: Position limit value range 2

PROFINET module identifier

Module-ID 1008
 Submodule-ID 1

Description

The position limit value range 2 parameter defines a distance range with lower and upper limits. If the measured value lies outside of the configured range, the corresponding bit is set in module 6 or, if configured, an output is set.

Parameter

Parameter	Description	Rel. addr.	Data type	Value	Default	Unit		CR to module
						Metr.	Inch	
a Lower pos. limit 2	Specifies the lower position limit.	0...3	sign 32 bit	-999999 ... +999999	0	mm	in/100	-
b Upper pos. limit 2	Specifies the upper position limit.	4...7	sign 32 bit	-999999 ... +999999	0	mm	in/100	-
Parameter length: 8 bytes								

Input data

None

Output data

None

9.9.3.9 Module 9: Error handling procedures

PROFINET module identifier

Module-ID	1009
Submodule-ID	1

Description

The module makes parameters available to handle any errors should they occur.

In the event of a temporary error in the value/velocity calculation (e.g. plausibility error caused by light beam interruption) the laser measurement system transmits the last valid measurement value for a length of time xx which is to be configured.

If the configured time is exceeded, the error display or the faulty measurement value output is activated.

Parameter

Parameter	Description	Rel. addr.	Data type	Value	Default	Unit		CR to module
						Metr.	Inch	
a Position value in the case of error	Specifies which position value is to be output in the event of an error after the position suppression time has elapsed.	0.0	Bit	0: Last valid value 1: Zero	1	mm	in/100	–
	No function.	0.1	Bit	Always 0	0	–	–	–
b Suppress position status	Specifies whether the PLB status bit is set immediately in the event of an error or if it is suppressed for the configured position suppression time.	0.2	Bit	0: OFF 1: ON	1	–	–	–
c Error delay (position)	Specifies in the event of an error whether the position value immediately outputs the value of the "position value in the case of error" parameter or outputs the last valid position value for the duration of the configured "error delay time".	0.3	Bit	0: OFF 1: ON	1	–	–	–
d Error delay time (position)	Errors which occur are suppressed for the configured time. If no valid position value can be ascertained during the configured time, the last valid position value is output. If the error persists after the time elapses, the value stored in the "position value in the case of error" parameter is output.	1...2	unsign 16 bit	100 ... 1000	100	ms	–	–
e Velocity in the case of error	Specifies which velocity is to be output in the event of an error after the velocity suppression time has elapsed.	3.0	Bit	0: Last valid value 1: Zero	1	–	–	–
	No function.	3.1	Bit	Always 0	0	–	–	–
f Suppress velocity status	Specifies whether the PLB status bit is set immediately in the event of an error or if it is suppressed for the configured velocity suppression time.	3.2	Bit	0: OFF 1: ON	1	–	–	–

g Error delay (velocity)	Specifies in the event of an error whether the velocity immediately outputs the value of the "velocity in the case of error" parameter or outputs the last valid velocity for the duration of the configured "error delay time".	3.3	Bit	0: OFF 1: ON	1	-	-
h Error delay time (velocity)	Errors which occur are suppressed for the configured time. If no velocity position value can be ascertained during the configured time, the last valid velocity value is output. If the error persists after the time elapses, the value stored in the "velocity in the case of error" parameter is output.	4...5	unsign 16 bit	200 ... 1000	200	ms	-
Parameter length: 6 bytes							

Input data

None

Output data

None

9.9.3.10 Module 10: Velocity

PROFINET module identifier

Module-ID 1010
Submodule-ID 1

Description

Outputs the current velocity with the configured resolution. The unit (metric or inch) is set in module 1 (position value) and also applies to the velocity. If module 1 is not configured, the AMS 348*i* SSI operates with the default unit (metric).

The sign of the velocity is dependent on the count direction in module 1d.

In the default setting a positive velocity is output when the reflector moves away from the AMS 348*i* SSI. When the reflector moves towards the AMS 348*i* SSI, negative velocities are output. If the "negative" count direction is configured in module 1, the velocity signs are reversed.

Measurement value preparation averages all velocity values calculated during the selected period (averaging) to yield a velocity output value.

Parameter

Parameter	Description	Rel. addr.	Data type	Value	Default	Unit		CR to module
						Metr.	Inch	
a Velocity resolution	The parameter specifies the resolution for the velocity value.	0.0 ... 0.2	Bit	001=1: 1 010=2: 10 011=3: 100 100=4: 1000 101 = 5: free resolution	1	mm/s	(in/ 100) /s	20b
b Average	The parameter specifies the integration time (averaging time) of the calculated velocity values.	0.3 ... 0.5	Bit	000=0: 2 001=1: 4 010=2: 8 011=3: 16 100=4: 32 101=5: 64 110=6: 128	3	ms		–
Parameter length: 2 bytes								

Input data

Input data	Description	Rel. addr.	Data type	Value	Default	Unit		CR to module
						Metr.	Inch	
c Velocity	Current velocity.	0	sign 32 bit	-999999 ... +999999	0	scaled		–
Input data length: 4 bytes consistently								

Output data

None

9.9.3.11 Module 11: Static velocity limit value 1

PROFINET module identifier

Module-ID 1011
 Submodule-ID 1

Description

The **static velocity limit value 1** function compares the current velocity with a velocity stored in the configuration. This occurs in the configured range, which is defined by **range start** and **range end**.



Notice!

If **range start** and **range end** are identical, velocity monitoring is not activated.

If a direction-dependent limit value check is activated via the **direction selection** parameter, the values of **range start** and **range end** also define the direction. The check is always performed from **range start** to **range end**. For example, if the range start is "5500" and the range end is "5000", the direction-dependent check is only performed in the direction from "5500" to "5000". The limit value is not active in the opposite direction.

If the check is independent of direction, the order of **range start** and **range end** is irrelevant. Depending on the selected **switching mode**, if the value is above or below the defined limits, the limit value status in module 16 is set and, if configured, the output is appropriately set via module 4 or 5.



Notice!

The explanations given above on the "Range start" and "Range end" parameters apply analogously for modules 12-15.

Parameter

Parameter	Description	Rel. addr.	Data type	Value	Default	Unit		CR to module
						Metr.	Inch	
a Switching mode	Condition for the "velocity limit value 1" signal, which applies to the output (module 4/5) and the status bit (module 16).	0.0	Bit	0: Value greater than limit 1: Value less than limit	0	–		–
b Direction selection	Selection of direction-dependent or direction-independent limit value checking.	0.1	Bit	0: Direction independent 1: Direction dependent	0	–		–
c Velocity limit value 1	Limit value is compared to the current velocity.	1...2	unsigned 16 bit	0 ... 20000	0	mm/s	(in/100)/s	16d
d Velocity hysteresis 1	Relative shift to prevent signal bouncing.	3...4	unsigned 16 bit	0 ... 20000	100	mm/s	(in/100)/s	–

e Limit value 1 range start	The velocity limit value is monitored beginning at this position.	5...8	sign 32 bit	-999999 ... +999999	0	mm	in/100	-
f Limit value 1 range end	The velocity limit value is monitored up to this position.	9 ... 12	sign 32 bit	-999999 ... +999999	0	mm	in/100	-
Parameter length: 13 bytes								

Input data

None

Output data

None

9.9.3.12 Module 12: Static velocity limit value 2

PROFINET module identifier

Module-ID 1012
 Submodule-ID 1

Description

The **static velocity limit value 2** function compares the current velocity with a velocity stored in the configuration. This occurs in the configured range, which is defined by **range start** and **range end**.



Notice!

Further explanations on the "Range start" and "Range end" parameters see chapter 9.9.3.11 "Module 11: Static velocity limit value 1".

Parameter

Parameter	Description	Rel. addr.	Data type	Value	Default	Unit		CR to module
						Metr.	Inch	
a Switching mode	Condition for the "velocity limit value 2" signal, which applies to the output (module 4/5) and the status bit (module 16).	0.0	Bit	0: Value greater than limit 1: Value less than limit	0	–		–
b Direction selection	Selection of direction-dependent or direction-independent limit value checking.	0.1	Bit	0: Direction independent 1: Direction dependent	0	–		–
c Velocity limit value 2	Limit value is compared to the current velocity.	1...2	unsign 16 bit	0 ... 20000	0	mm/s	(in/100)/s	16e
d Velocity hysteresis 2	Relative shift to prevent signal bouncing.	3...4	unsign 16 bit	0 ... 20000	100	mm/s	(in/100)/s	–
e Limit value 2 range start	The velocity limit value is monitored beginning at this position.	5...8	sign 32 bit	-999999 ... +999999	0	mm	in/100	–
f Limit value 2 range end	The velocity limit value is monitored up to this position.	9...12	sign 32 bit	-999999 ... +999999	0	mm	in/100	–
Parameter length: 13 bytes								

Input data

None

Output data

None

9.9.3.13 Module 13: Static velocity limit value 3

PROFINET module identifier

Module-ID 1013
 Submodule-ID 1

Description

The **static velocity limit value 3** function compares the current velocity with a velocity stored in the configuration. This occurs in the configured range, which is defined by **range start** and **range end**.



Notice!

Further explanations on the "Range start" and "Range end" parameters see chapter 9.9.3.11 "Module 11: Static velocity limit value 1".

Parameter

Parameter	Description	Rel. addr.	Data type	Value	Default	Unit		CR to module
						Metr.	Inch	
a Switching mode	Condition for the "velocity limit value 3" signal, which applies to the output (module 4/5) and the status bit (module 16).	0.0	Bit	0: Value greater than limit 1: Value less than limit	0	-		-
b Direction selection	Selection of direction-dependent or direction-independent limit value checking.	0.1	Bit	0: Direction independent 1: Direction dependent	0	-		-
c Velocity limit value 3	Limit value is compared to the current velocity.	1...2	unsign 16 bit	0 ... 20000	0	mm/s	(in/100)/s	16f
d Velocity hysteresis 3	Relative shift to prevent signal bouncing.	3...4	unsign 16 bit	0 ... 20000	100	mm/s	(in/100)/s	-
e Limit value 3 range start	The velocity limit value is monitored beginning at this position.	5...8	sign 32 bit	-999999 ... +999999	0	mm	in/100	-
f Limit value 3 range end	The velocity limit value is monitored up to this position.	9 ... 12	sign 32 bit	-999999 ... +999999	0	mm	in/100	-
Parameter length: 13 bytes								

Input data

None

Output data

None

9.9.3.14 Module 14: Static velocity limit value 4

PROFINET module identifier

Module-ID 1014
 Submodule-ID 1

Description

The **static velocity limit value 4** function compares the current velocity with a velocity stored in the configuration. This occurs in the configured range, which is defined by **range start** and **range end**.



Notice!

Further explanations on the "Range start" and "Range end" parameters see chapter 9.9.3.11 "Module 11: Static velocity limit value 1".

Parameter

Parameter	Description	Rel. addr.	Data type	Value	Default	Unit		CR to module
						Metr.	Inch	
a Switching mode	Condition for the "velocity limit value 4" signal, which applies to the output (module 4/5) and the status bit (module 16).	0.0	Bit	0: Value greater than limit 1: Value less than limit	0	–		–
b Direction selection	Selection of direction-dependent or direction-independent limit value checking.	0.1	Bit	0: Direction independent 1: Direction dependent	0	–		–
c Velocity limit value 4	Limit value is compared to the current velocity.	1...2	unsign 16 bit	0 ... 20000	0	mm/s	(in/100)/s	16 g
d Velocity hysteresis 4	Relative shift to prevent signal bouncing.	3...4	unsign 16 bit	0 ... 20000	100	mm/s	(in/100)/s	–
e Limit value 4 range start	The velocity limit value is monitored beginning at this position.	5...8	sign 32 bit	-999999 ... +999999	0	mm	in/100	–
f Limit value 4 range end	The velocity limit value is monitored up to this position.	9...12	sign 32 bit	-999999 ... +999999	0	mm	in/100	–
Parameter length: 13 bytes								

Input data

None

Output data

None

9.9.3.15 Module 15: Dynamic velocity limit value

PROFINET module identifier

Module-ID 1015
Submodule-ID 1

Description

The **dynamic velocity limit value** compares the current velocity with a stored velocity within the defined range. If the value is above or below the limit value, the dynamic limit value status in module 16 is set and, if configured, the output is appropriately set. **Limit value, hysteresis, range start** and **range end** are transferred with the output data of this module by the PROFINET master. The transferred values are activated by **Bit 0.0**, i.e. if this bit is set, the AMS 348f SSI compares the current velocity with the new limit value conditions.



Notice!

Further explanations on the “Range start” and “Range end” parameters see chapter 9.9.3.11 “Module 11: Static velocity limit value 1”.

Parameter

None

Input data

None

Output data

Output data	Description	Rel. addr.	Data type	Value	Default	Unit		CR to module
						Metr.	Inch	
a Limit value control	Controls internal processing of the transferred dynamic limit value parameters.	0.0	Bit	0: Do not process 1: Process parameter	–	–	–	–
b Switching mode	Condition for the signal change of the output/status bit.	0.1	Bit	0: Value greater than limit 1: Value less than limit	–	–	–	–
c Direction selection	Selection of direction-dependent or direction-independent limit value checking.	0.2	Bit	0: Direction independent 1: Direction dependent	–	–	–	–
d Velocity limit value	Limit value is compared to the current velocity.	1...2	unsign 16 bit	0 ... +20000	–	mm/s	(in/100)/s	16 h
e Velocity hysteresis	Relative shift to prevent signal bouncing.	3...4	unsign 16 bit	0 ... +20000	–	mm/s	(in/100)/s	–
f Limit value range start	The velocity limit value is monitored beginning at this position.	5...8	sign 32 bit	-999999 ... +999999	0	mm	in/100	–
g Limit value range end	The velocity limit value is monitored up to this position.	9...12	sign 32 bit	-999999 ... +999999	0	mm	in/100	–
Output data length: 13 bytes consistently								

9.9.3.16 Module 16: Velocity status

PROFINET module identifier

Module-ID 1016
 Submodule-ID 1

Description

This module supplies the PROFINET master with various status information for velocity measurement.

Parameter

None

Input data

Input data	Description	Rel. addr.	Data type	Value	Default	Unit		CR to module
						Metr.	Inch	
a Velocity measurement error	Signals that no valid velocity could be ascertained.	1.0	Bit	0: OK 1: Error	–	–	–	–
b Movement status	Signals whether a movement >0.1 m/s is currently being detected.	1.1	Bit	0: No movement 1: Movement	–	–	–	–
c Movement direction	When the movement status is activated, this bit indicates the direction.	1.2	Bit	0: Positive direction 1: Negative direction	–	–	–	–
d Velocity limit value status 1	Signals that limit value 1 has been exceeded.	1.3	Bit	0: Limit value maintained 1: Limit value violated	–	–	–	11c
e Velocity limit value status 2	Signals that limit value 2 has been exceeded.	1.4	Bit	0: Limit value maintained 1: Limit value violated	–	–	–	12c
f Velocity limit value status 3	Signals that limit value 3 has been exceeded.	1.5	Bit	0: Limit value maintained 1: Limit value violated	–	–	–	13c
g Velocity limit value status 4	Signals that limit value 4 has been exceeded.	1.6	Bit	0: Limit value maintained 1: Limit value violated	–	–	–	14c
h Dynamic velocity limit value status	Signals that the dynamic limit value has been exceeded.	1.7	Bit	0: Limit value maintained 1: Limit value violated	–	–	–	15bd
i Velocity comparison Limit value 1	Signals whether the current velocity is compared with this limit value.	0.3	Bit	0: Comparison not active 1: Comparison active	–	–	–	–

j Velocity comparison Limit value 2	Signals whether the current velocity is compared with this limit value.	0.4	Bit	0: Comparison not active 1: Comparison active	–	–	–
k Velocity comparison Limit value 3	Signals whether the current velocity is compared with this limit value.	0.5	Bit	0: Comparison not active 1: Comparison active	–	–	–
l Velocity comparison Limit value 4	Signals whether the current velocity is compared with this limit value.	0.6	Bit	0: Comparison not active 1: Comparison active	–	–	–
m Dynamic velocity comparison	Signals whether the current velocity is compared with this limit value.	0.7	Bit	0: Comparison not active 1: Comparison active	–	–	–
Input data length: 2 bytes							

Output data

None

9.9.3.17 Module 17: SSI interface

PROFINET module identifier

Module ID	1017
Submodule-ID	1

Description

The module defines the parameters for the SSI interface.



Attention!

The SSI interface can only represent positive distance values. If negative output values are ascertained due to the offset or count direction, a zero value is output at the SSI interface! In the event of a number overflow, all data bits are set to "1".

The **unit**, **offset** and **count direction** parameters of module 1 also apply to the SSI interface.



Notice!

If the SSI interface is not configured via module 17 (SSI interface) in PROFINET operation, the SSI interface is deactivated.

If the SSI interface is operated without PROFINET (PROFINET OFF/SSI ON), configuration is performed via the display.

Parameter

Parameter	Description	Rel. addr.	Data type	Value	Default	Unit		CR to module
						Metr.	Inch	
a Coding	The parameter defines the coding of the SSI data.	0.0	Bit	0: Binary 1: Gray	1	-		-
b Mode	The parameter defines the number of data bits.	0.1 ... 0.2	Bit	00=0: 24Bit 01=1: 25Bit 10=2: 26Bit	0	-		-
c Resolution	The parameter defines the resolution of the SSI position value.	0.3 ... 0.5	Bit	001=1: 0.001 010=2: 0.01 011=3: 0.1 100=4: 1 101=5: 10 110=6: Free resolution	3	mm	in/100	1b 6d 19a
d Clock frequency		0.7	Bit	0: 80kHz - 800kHz monoflop time 20us 1: 50kHz - 79 kHz monoflop time 30us	0			
e Error bit Attention! The attached error bit always has the following significance: 0: No error 1: Error	Error bit off/on The parameter defines the meaning of the error bit. If the error bit = OFF , no bit is attached to the data. The remaining bits 1 to 6 activate the various events which apply to the error bit. The bits are OR -linked to each other.	1.0	Bit	0: OFF 1: ON	1	-		-
	Overflow Output value exceeds the maximum value which can be represented. In the event of an overflow, all data bits are set to 1.	1.1	Bit	0: OFF 1: ON	0	-		-
	Intensity (ATT) If the intensity of the received signal is less than the warning threshold, the bit is set.	1.2	Bit	0: OFF 1: ON	0	-		-
	Temperature (TMP) Maximum internal device temperature exceeded.	1.3	Bit	0: OFF 1: ON	0	-		-
	Laser (LSR) Laser prefailure message.	1.4	Bit	0: OFF 1: ON	0	-		-
	Plausibility (PLB) Plausibility error.	1.5	Bit	0: OFF 1: ON	1	-		-
	Hardware (ERR) Hardware error.	1.6	Bit	0: OFF 1: ON	1	-		-
Parameter length: 2 bytes								



Notice!

Resolution and maximum position value which can be represented:

SSI setting	Max. distance which can be represented metric	Max. distance which can be represented inches (in)	
24-bit; resolution 0.1	1,677 m	16,777 in	≈ 426m
24-bit; resolution 0.01	167 m	1,677 in	≈ 42m
24-bit; resolution 0.001	16 m	167 in	≈ 4m
25-bit; resolution 0.1	3,355 m	33,554 in	≈ 852m
25-bit; resolution 0.01	335 m	3,355 in	≈ 85m
25-bit; resolution 0.001	33 m	335 in	≈ 8m
26-bit; resolution 0.1	6,710 m	67,108 in	≈ 1,704m
26-bit; resolution 0.01	671 m	6,710 in	≈ 170m
26-bit; resolution 0.001	67 m	671 in	≈ 17m

Figure 9.18: SSI interface - resolution and maximum position value which can be represented

9.9.3.19 Module 18: Other

PROFINET module identifier

Module-ID 1018
 Submodule-ID 1

Description

General operating parameters such as display language, lighting and contrast, password, heating control, etc. are set in this module.

Parameter

Parameter	Description	Rel. addr.	Data type	Value	Default	Unit		CR to module
						Metr.	Inch	
a Language selection	Language selection for the display. A language which was selected via the display is overwritten by this parameter.	0.0 ... 0.2	Bit	000=0: English 001=1: German 010=2: Italian 011=3: Spanish 100=4: French	0	-		-
b Display illumination	Off after 10 min. or always on.	0.3	Bit	0: Off after 10 min. 1: Always on	0	-		-
c Display contrast	Contrast setting of the display. The contrast changes under extreme ambient temperatures and can be adjusted with this parameter.	0.4 ... 0.5	Bit	000=0: Weak 001=1: Medium 010=2: Strong	1	-		-
d Password protection	Password protection on/off	0.7	Bit	0: OFF 1: ON	0	-		-
e Password	Specifies the password. Password protection must be on.	1...2	unsign 16 bit	0000 ... 9999	0000	-		-
f Heating control	Defines a switch-on/switch-off range for the heating control. The extended switch-on/switch-off range for heating may provide relief in the event of condensation problems. There is no guarantee that no condensation will occur on the optics in the extended switch-on/switch-off range due to the limited heating capacity. This parameter is available as standard, but functions only for devices with integrated heating (AMS 348i SSI... H).	3.0	Bit	0 = Standard (10°C ... 15°C) 1 = Extended (30°C ... 35°C)	0	-		-
Parameter length: 4 bytes								

Input data

None

Output data

None

9.9.3.20 Module 20: free resolution

PROFINET module identifier

Module-ID 1020
 Submodule-ID 1

Description

Free resolution is used when the resolutions set in the standard are not appropriate. If a free resolution is used, this must be activated in module 1c for the position or in module 10a for the velocity.

Both module 20 and module 1c or 10a must be set for configuration of the free resolution.

Parameter

Parameter	Description	Rel. addr.	Data type	Value	Default	Unit		CR to module
						Metr.	Inch	
a Free resolution position	This module allows the output measurement values for position and velocity to be freely scaled.	0 ... 1	unsign 16 bit	5 ... 50000	1000	mm/10 ³	in/10 ⁵	1c
b Free resolution velocity	The parameters apply to all interfaces for which the "free resolution" resolution was selected. The internal measurement value is multiplied by the set value on the basis of (mm/1000). Example: Value "3000" means that in the event of a change in the measurement value by 3 mm, the position value in the binary code changes by binary 1. Due to the free resolution in the example, an internal measurement value of 3333mm gives an output value of "1111". The resolution of the "Offset", "Preset" and "Limit values" parameters is not affected by free resolution.	2 ... 3	unsign 16 bit	5 ... 50000	1000	(mm/10 ³)/s	(in/10 ⁵)/s	10a
Parameter length: 4 bytes								

10 SSI

10.1 Principle functionality of the SSI interface

Data communication of the SSI interface is based on differential transmission as used for RS 422 interfaces. Transmission of the position value, beginning with the MSB (most significant bit), is thus synchronised with a clock cycle (CLOCK) specified by the control.

In the quiescent state both the clock line as well as the data line are at HIGH level. At the first HIGH-LOW edge (point ① in figure 10.1) the data in the internal register are stored. Thus it is ensured that the data cannot change during serial transmission.

When the next clock signal change from LOW to HIGH level (point ② in figure 10.1) occurs transmission of the position value begins with the most significant bit (MSB). With each successive change of the clock signal from LOW to HIGH level the next least-significant bit is transmitted on the data line. After the least significant bit (LSB) has been output, the clock signal switches from LOW to HIGH for one last time and the data line switches to LOW level (end of transmission).

A monoflop retriggered by the clock signal determines the time span before the SSI interface can be called for the next transmission. This results in the minimum pause time between two successive clock cycles. If time $t_m = 20\mu\text{s}$ has elapsed, the data line is returned to the quiescent level (HIGH) (point ③ in figure 10.1). This signals completed data communication and that the device is again ready for transmission.



Notice!

If the off-cycle of data transmission is interrupted for longer than $t_m = 20\mu\text{s}$, the next cycle will begin with a completely new transmission cycle with a newly calculated value.

If a new transmission cycle is started before time t_m has elapsed, the previous value is output again.



Attention!

The SSI interface can only represent positive distance values. If negative output values are ascertained due to the offset or count direction, a zero value is output at the SSI interface! In the event of a number overflow, all data bits are set to "1".

10.1.1 SSI sequence diagram

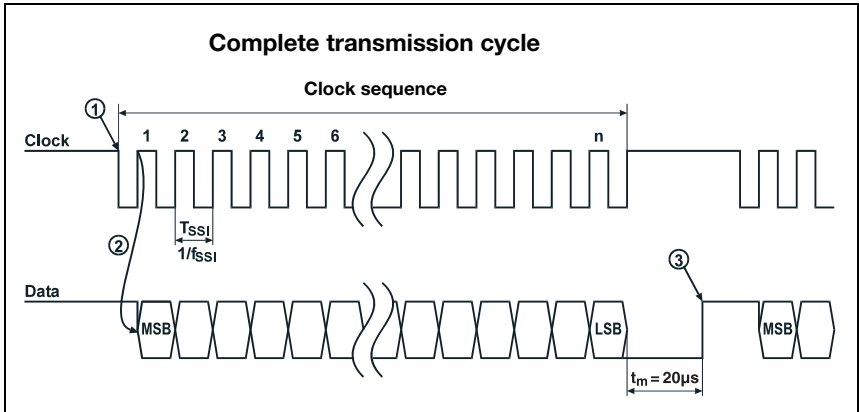

Figure 10.1: SSI data transmission sequence diagram



Notice!

In the default setting the **LSB** bit is the error bit.



Attention!

Significance of the error bit:

By default a 25th error bit (LSB) is appended to the 24-bit measurement value.

The error bit is not included in the Gray coding of the measurement value.

The error bit is 1 = active, 0 = not active.



Notice!

The data can be read out with a clock rate between 80kHz and 800kHz.



Attention!

Updating the measurement values on the SSI interface of the AMS 348i SSI:

The measurement value on the SSI interface of the AMS 348i SSI is updated every 1.7ms (default) independent of the clock frequency.

The update rate on the interface can be reduced to 0.2ms via the display under the SSI menu item or in PROFINET module 17.

The shorter update rate is only valid for the SSI interface and has no influence on the PROFINET interface.

10.1.2 Cable length as a function of the data rate

Only shielded and twisted pair lines (pin 1 with 2 and pin 3 with 4) are permitted as data lines for the SSI interface (see chapter 10.2 "SSI - Electrical connection").

↳ The shielding must be connected at both ends.

↳ Do not lay the cable parallel to power cables.

The maximum possible cable length is dependent on the cable used and the clock rate:

Data rate	80kBit/s	100kBit/s	200kBit/s	300kBit/s	400kBit/s	500kBit/s	1,000kBit/s
Max. cable length (typical)	500m	400m	200m	100m	50m	25m	10m

Table 10.1: Max. cable length as a function of the clock rate

10.2 SSI - Electrical connection

SSI connector (5-pin plug, B-coded)		
Pin	Name	Remark
1	DATA+	+ Data line SSI (output)
2	DATA-	- Data line SSI (output)
3	CLK+	+ Clock line SSI (input electrically insulated)
4	CLK-	- Clock line SSI (input electrically insulated)
5	FE	Functional earth
Thread	FE	Functional earth (housing)

Figure 10.2: SSI - electrical connection



Notice!

To connect the SSI interface we recommend our ready-made SSI cables, see "Order codes for SSI connection cables" on page 117.

10.3 General Information to the AMS 348i SSI parameters



Attention!

Using the PROFINET and SSI interface simultaneously:

The SSI interface settings are performed by the PROFINET. If settings which differ from the default settings for the parameters, are to be used, they must be configured via module 17 (SSI interface).

Using the SSI interface without PROFINET:

For this operating mode deactivate the PROFINET via the display (PROFINET = OFF). Default parameters are stored in the laser measurement system for the sole use of the SSI interface. The preset default parameters can be changed at any time via the display. This also applies when using parameters which do not relate directly to the SSI interface (for example: I/O 1 or I/O 2, position value or others). The SSI interface remains active even during parameter enabling. Changes to parameters have an immediate effect.

10.4 Default settings of the SSI interface

Default parameters which apply only to the SSI interface.	
SSI activation	ON
Measurement value coding	Gray
Transmission mode	24-bit measurement value + 1-bit error (error: 1 = active), error bit = LSB
Resolution	0.1 mm
Default error bit	Plausibility error or hardware error
Update rate	1.7 ms
Default parameters which apply to both PROFINET and SSI.	
Measurement unit	Metric
Count direction	Positive (the SSI interface cannot represent negative values)
I/O 1	Output – plausibility error or hardware error
I/O 2	Output – temperature error, intensity error or laser prefailures message
Static preset	+000.000
Dynamic preset	+000.000
Position limit value range 1	Lower limit and upper limit: both 0
Position limit value range 2	Lower limit and upper limit: both 0
Error handling procedures	Position output: 0
	Suppress position status: active
	Position suppression time: 100ms
Display language	English
Display illumination	OFF after 10 min.
Display contrast	Medium
Password protection	Off
Password	0000

Table 10.2: Default settings of the SSI interface

10.4.1 Changing the SSI settings via the display

**Notice!**

For basic operation of the display please refer to chapter 8.2.3.

In order to change the parameters please activate parameter enabling.

The SSI interface remains active even during parameter enabling. Changes to parameters have an immediate effect.

11 Diagnostics and troubleshooting

For the PROFINET, there are two different options for diagnosis.

Event-related diagnostics

PROFINET transmits events within an automation process as alarms that must be acknowledged by the application process.

The following events are possible:

- Process alarms: Events that originate from the process and are reported to the control.
- Diagnostic alarms: Events that indicate the malfunctioning of an IO device.
- Maintenance alarms: Transmission of information to avoid the failure of a device through preventative maintenance work.
- Manufacturer-specific diagnostics

To identify the alarms uniquely, they are always reported via a slot/subslot. The user can prioritize diagnostic and process alarms differently.

State-related diagnostics

In addition, all alarms are entered into the diagnostics buffer. If required, this buffer can be read by a primary instance via acyclic read services.

A further option to report malfunctioning or status changes in a field device to a plant control is to enter low-priority diagnostic or status messages into the diagnostic buffer only instead of actively reporting them to the primary control.

This option can also be used for preventative maintenance or for low-priority warnings, for example.

The AMS 348*i* uses both the event-related diagnostics for high-prioritized events/errors as well as the state-related diagnostics for preventative maintenance and the signaling of low-prioritized events or warnings.

The following alarms and diagnostics messages are supported:

Diagnostics	Description	AMS 348/ category	API/ Slot/ Subslot	Type	Coming/ going	Remark
Parameter error	Error in the configuration of a module.	Error	0/n ¹⁾ /0	Diagnostics alarm ²⁾	Coming only	
Configuration error	Error in the configuration of a module.	Error	0/n/0	Diagnostics alarm	Coming only	

1) n = module number

2) Only diagnostics or process alarms actually trigger the transmission of an alarm. All other types (preventative maintenance and status messages) only lead to an entry into the diagnostics buffer and are thus part of the state-based diagnostics.

Table 11.1: AMS 348*i* alarm and diagnostics messages

11.1 Service and diagnostics in the display of the AMS 348i SSI

In the main menu of the AMS 348i SSI, expanded "Diagnostics" can be called up under the Service heading.

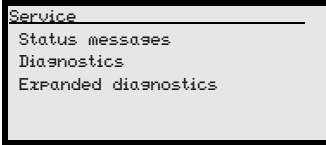

From the *Service* main menu, press the enter button (↵) to access the underlying menu level.

Use the up/down buttons (▲▼) to select the corresponding menu item in the selected level; use the enter button (↵) to activate the selection.

Return from any sub-level to the next-higher menu item by pressing the ESC button (⏏).

11.1.1 Status messages

The status messages are written in a ring memory with 25 positions. The ring memory is organized according to the FIFO principle. No separate activation is necessary for storing the status messages. Power OFF clears the ring memory.

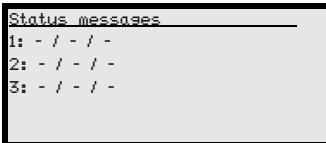

Basic representation of the status messages

n: Type / No. / 1

Meaning:

n: memory position in the ring memory

Type: type of message:

I = info, **W** = warning, **E** = error, **F** = severe system error

No: internal error detection

1: frequency of the event (always "1", since no summation occurs)

The status messages within the ring memory are selected with the up/down buttons (▲▼). The enter button (↵) can be used to call up **detailed information** on the corresponding status messages with the following details:

Detailed information about a status message

Type: type of message + internal counter

UID: Leuze internal coding of the message

ID: description of the message

Info: not currently used

Within the detailed information, the enter button (↵) can be pressed again to activate an **action menu** with the following functions:

- Acknowledge message
- Delete message
- Acknowledge all
- Delete all

11.1.2 Diagnostics

The diagnostics function is activated by selecting the `Diagnostics` menu item. The ESC button (ESC) deactivates the diagnostics function and clears the contents of the recordings.

The recorded diagnostic data are displayed in 2 fields. In the upper half of the display, status messages of the AMS and the bar graph are displayed. The lower half contains information that assists in a Leuze-internal evaluation.

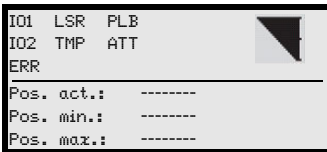

Use the up/down buttons (▲▼) to scroll in the bottom half between various displays. The contents of the scrollable pages are intended solely for Leuze for internal evaluation.

The diagnostics have no influence on the communication to the host interface and can be activated during operation of the AMS 348i SSI.

11.1.3 Expanded diagnostics

The `Expanded diagnostics` menu item is used for Leuze-internal evaluation.

11.2 General causes of errors

LINK LED for BUS IN and BUS OUT

A green/orange multicolor LED below the BUS IN and BUS OUT connectors indicates the EtherNet/PROFINET connection status.



Green continuous light

Power LINK green

- The link exists, the hardware connection to the next connected participant is OK. The LED signals the same status as "LNK0" and "LNK1" in the display.



Orange flashing

LINK LED flashing orange (ACT0/ACT1)

- Data is exchanged with the connected participants.

11.2.1 Power LED

See also chapter 8.2.2.

Error	Possible error cause	Measure
PWR LED "OFF"	No supply voltage connected Hardware error	Check supply voltage. Send in device.
PWR-LED "flashes red"	Light beam interruption Plausibility error	Check alignment. Traverse rate >10m/s.
PWR-LED "static red"	Hardware error	For error description, see display, It may be necessary to send in the device.

Table 11.2: General causes of errors

11.3 Interface errors

11.3.1 BUS LED

11.4 Status display in the display of the AMS 348i SSI

Error	Possible error cause	Measure
BUS LED "OFF"	No supply voltage connected to the device	Check supply voltage.
	Device not yet recognized by the PROFINET	Send device to customer service.
	Hardware error	
BUS-LED "flashes red"	Incorrect wiring.	Check wiring.
	Communication error: parameterization or configuration failed ("parameter failure")	<ul style="list-style-type: none"> Check configuration, in particular with respect to address assignment (device names/IP address/MAC ID). Carry out a reset on the control.
	IO Error: no data exchange	
BUS LED "static red"	Incorrect wiring.	Check wiring.
	Communication error on the PROFINET. No communication established to the controller (no data exchange)	<ul style="list-style-type: none"> Check protocol settings. Check configuration, in particular with respect to address assignment (device names/IP address/MAC ID).
	Different protocol settings	Check protocol settings.
	Protocol not released	Activate TCP/ IP or UDP.
	Wrong device name set	<ul style="list-style-type: none"> Check configuration, in particular with respect to address assignment (device names/IP address/MAC ID).
Sporadic network error	Check wiring for proper contacting	Check wiring, <ul style="list-style-type: none"> In particular, check wire shielding. Check wires used.
	EMC coupling	<ul style="list-style-type: none"> Observe contact quality of screwed or soldered contacts in the wiring. Avoid EMC coupling caused by power cables laid parallel to device lines. Separate laying of power and data communications cables.
	Network expansion exceeded	Check max. network expansion as a function of the max. cable lengths.

Table 11.3: Bus error

Display	Possible error cause	Measure
PLB (implausible measurement values)	Laser beam interruption	Laser spot must always be incident on the reflector.
	Laser spot outside of reflector	Traverse rate < 10 m/s?
	Measurement range for maximum distance exceeded	Restrict traversing path or select AMS with larger measurement range.
	Velocity greater than 10 m/s	Reduce velocity.
	Ambient temperature far outside of the permissible range (TMP display; PLB)	Select AMS with heating or ensure cooling.

Display	Possible error cause	Measure
ATT (insufficient received signal level)	Reflector soiled	Clean reflector or glass lens.
	Glass lens of the AMS soiled	
	Performance reduction due to snow, rain, fog, condensing vapor, or heavily polluted air (oil mist, dust)	Optimize usage conditions.
	Laser spot only partially on the reflector	Check alignment.
	Protective foil on the reflector	Remove protective foil from reflector.
TMP (operating temperature outside of specification)	Ambient temperatures outside of the specified range	In case of low temperatures, remedy may be an AMS with heating. If temperatures are too high, provide cooling or change mounting location.
LSR Laser diode warning	Laser diode prefailure message	Send in device at next possible opportunity to have laser diode replaced. Have replacement device ready.
ERR Hardware error	Indicates an uncorrectable error in the hardware	Send in device for repair.



Notice!

Please use **chapter 11 as a master copy** should servicing be required.

Cross the items in the "Measures" column which you have already examined, fill out the following address field and fax the pages together with your service contract to the fax number listed below.

Customer data (please complete)

Device type:	
Company:	
Contact partner / department:	
Phone (direct):	
Fax:	
Street / No:	
ZIP code/City:	
Country:	

Leuze Service fax number:

+49 7021 573 - 199

12 Type overview and accessories

12.1 Type key

AMS	3xx	i	yyy	H	SSI
				Heating option	SSI = With SSI interface
				Sensing distance	H = With heating
					40 Max. operating range in m
					120 Max. operating range in m
					200 Max. operating range in m
					300 Max. operating range in m
				Interface	i = Integrated fieldbus technology
					00 RS 422/RS 232
					01 RS 485
					04 PROFIBUS DP / SSI
					08 TCP/IP
					35 CANopen
					38 EtherCAT
					48 PROFINET RT
					55 DeviceNet
					58 Ethernet/IP
					84 Interbus
					AMS Absolute Measuring System

12.2 Type overview AMS 348*i* SSI (PROFINET + SSI)

Type designation	Description	Part no.
AMS 348/40 SSI	40m operating range, PROFINET/SSI interface	50127219
AMS 348/120 SSI	120m operating range, PROFINET/SSI interface	50127220
AMS 348/200 SSI	200m operating range, PROFINET/SSI interface	50127221
AMS 348/300 SSI	300m operating range, PROFINET/SSI interface	50127222
AMS 348/40 H SSI	40m operating range, PROFINET/SSI interface, integrated heating	50127223
AMS 348/120 H SSI	120m operating range, PROFINET/SSI interface, integrated heating	50127224
AMS 348/200 H SSI	200m operating range, PROFINET/SSI interface, integrated heating	50127225
AMS 348/300 H SSI	300m operating range, PROFINET/SSI interface, integrated heating	50127226

Table 12.1: Type overview AMS 348*i* SSI

12.3 Overview of reflector types

Type designation	Description	Part no.
Reflective tape 200x200-S	Reflective tape, 200x200mm, self-adhesive	50104361
Reflective tape 500x500-S	Reflective tape, 500x500mm, self-adhesive	50104362
Reflective tape 914x914-S	Reflective tape, 914x914mm, self-adhesive	50108988
Reflective tape 200x200-M	Reflective tape, 200x200mm, affixed to aluminum plate	50104364
Reflective tape 500x500-M	Reflective tape, 500x500mm, affixed to aluminum plate	50104365
Reflective tape 914x914-M	Reflective tape, 914x914mm, affixed to aluminum plate	50104366
Reflective tape 200x200-H	Heated reflective tape, 200 x 200mm	50115020
Reflective tape 500x500-H	Heated reflective tape, 500 x 500mm	50115021
Reflective tape 914x914-H	Heated reflective tape, 914 x 914mm	50115022

Table 12.2: Overview of reflector types

12.4 Accessories

12.4.1 Accessory mounting bracket

Type designation	Description	Part no.
MW OMS/AMS 01	Mounting bracket for mounting the AMS 348/SSI to horizontal surfaces	50107255

Table 12.3: Accessory mounting bracket

12.4.2 Accessory deflector unit

Type designation	Description	Part no.
US AMS 01	Deflector unit with integrated mounting bracket for the AMS 348/SSI. Variable 90° deflection of the laser beam in various directions	50104479
US 1 OMS	Deflector unit without mounting bracket for simple 90° deflection of the laser beam	50035630

Table 12.4: Accessory deflector unit

12.4.3 Accessory M12 connector

Type designation	Description	Part no.
S-M12A-ET	M12 connector, Ethernet, D-coded, BUS IN, BUS OUT	50112155
KDS ET M12/RJ45 W - 4P	Converter from M12 D-coded to RJ45 socket	50109832
KD 02-5-BA	M12 connector, B-coded socket, SSI	50038538
KD 02-5-SA	M12 connector, B-coded plug, SSI	50038537
KD 095-5A	M12 connector, A-coded socket, Power (PWR)	50020501

Table 12.5: Accessory M12 connector

12.4.5 Accessory ready-made cables for PROFINET

General

- Cable **KB ET...** for connecting to PROFINET via M12 connector
- Standard cable available in lengths from 2 ... 30m
- Special cables on request.

Contact assignments M12 PROFINET connection cable KB ET ...-SA

M12 PROFINET connection cable (4-pin connector, D-coded, on both sides)			
EtherNet	Pin	Name	Core color
<p>M12 connector (D-coded)</p>	1	TD+	yellow
	2	RD+	white
	3	TD-	orange
	4	RD-	blue
	SH (thread)	FE	bare

Core colors	
	WH
	YE
	BU
	OG
Conductor class: VDE 0295, EN 60228, IEC 60228 (Class 5)	

Accessories M12 PROFINET connection cable, open cable end

Cable designation: KB ET - ... - SA

Accessories PROFINET connection cable with both-sided D-coded M12 plug

Cable designation: KB ET - ... - SSA, cable assignment 1:1, not crossed

Accessories PROFINET connection cable, M12/RJ45

Cable designation: KB ET - ... - SA-RJ45



Notice for connecting the PROFINET interface!

The entire interconnection cable must be shielded. The shielding connection must be at the same potential on both ends of the data line. This prevents potential compensating currents over the shield and possible interference coupling by compensating currents. The signal lines must be stranded in pairs.

Use CAT 5 cable for the connection.

Specifications of the PROFINET connection cable

Operating temperature range in rest state: -50°C ... +80°C
 in motion: -25°C ... +80°C
 in motion: -25°C ... +60°C (when used with drag chains)

Material cable sheath: PUR (green), wire insulation: PE foam,
 free of halogens, silicone and PVC

Bending radius > 65 mm, suitable for drag chains

Bending cycles > 10⁶, perm. acceleration < 5m/s²

Order codes for PROFINET connection cables

Type designation	Description	Part no.
M12 plug for BUS IN, axial connector, open cable end		
KB ET - 1000 - SA	Cable length 1 m	50106738
KB ET - 2000 - SA	Cable length 2 m	50106739
KB ET - 5000 - SA	Cable length 5 m	50106740
KB ET - 10000 - SA	Cable length 10 m	50106741
KB ET - 15000 - SA	Cable length 15 m	50106742
KB ET - 20000 - SA	Cable length 20 m	50106743
KB ET - 25000 - SA	Cable length 25 m	50106745
KB ET - 30000 - SA	Cable length 30 m	50106746
M12 plug for BUS IN to RJ-45 connector		
KB ET - 1000 - SA-RJ45	Cable length 1 m, cable 1:1, not crossed	50109879
KB ET - 2000 - SA-RJ45	Cable length 2 m, cable 1:1, not crossed	50109880
KB ET - 5000 - SA-RJ45	Cable length 5 m, cable 1:1, not crossed	50109881
KB ET - 10000 - SA-RJ45	Cable length 10 m, cable 1:1, not crossed	50109882
KB ET - 15000 - SA-RJ45	Cable length 15 m, cable 1:1, not crossed	50109883
KB ET - 20000 - SA-RJ45	Cable length 20 m, cable 1:1, not crossed	50109884
KB ET - 25000 - SA-RJ45	Cable length 25 m, cable 1:1, not crossed	50109885
KB ET - 30000 - SA-RJ45	Cable length 30 m, cable 1:1, not crossed	50109886
M12 plug + M12 plug for BUS OUT to BUS IN		
KB ET - 1000 - SSA	Cable length 1 m, cable 1:1, not crossed	50106898
KB ET - 2000 - SSA	Cable length 2 m, cable 1:1, not crossed	50106899
KB ET - 5000 - SSA	Cable length 5 m, cable 1:1, not crossed	50106900
KB ET - 10000 - SSA	Cable length 10 m, cable 1:1, not crossed	50106901
KB ET - 15000 - SSA	Cable length 15 m, cable 1:1, not crossed	50106902
KB ET - 20000 - SSA	Cable length 20 m, cable 1:1, not crossed	50106903
KB ET - 25000 - SSA	Cable length 25 m, cable 1:1, not crossed	50106904
KB ET - 30000 - SSA	Cable length 30 m, cable 1:1, not crossed	50106905

12.4.6 Accessory ready-made cables for SSI

General

- **KB SSI...** cable for connecting to the SSI M12 connector
- Standard cables available in lengths from 2 ... 30m
- Special cables on request.

Contact assignments of SSI connection cable

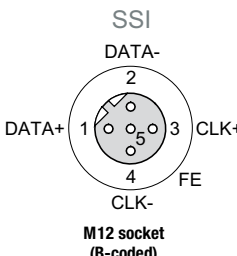
SSI/IBS connection cable (5-pin socket, B-coded)			
	Pin	Name	Core color
	1	DATA+	yellow
	2	DATA-	green
	3	CLK+	gray
	4	CLK-	pink
	5	FE	brown
	Thread	FE	bare

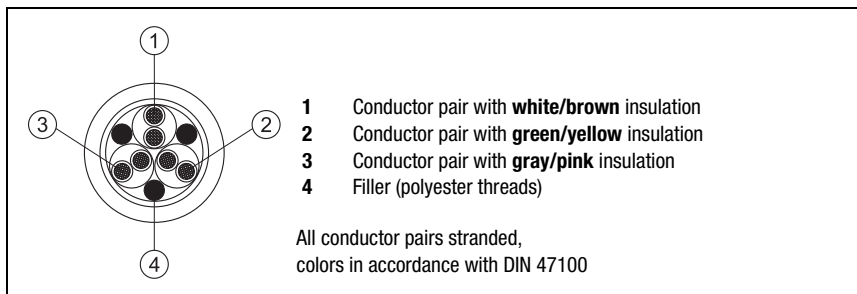

Specifications of the SSI connection cable

Operating temperature range in rest state: -40°C ... +80°C
 in motion: -5°C ... +80°C

Material the cables are free of halogens, silicone and PVC

Bending radius > 80mm, suitable for drag chains

Order codes for SSI connection cables

Type designation	Remark	Part no.
KB SSI/BS-2000-BA	M12 socket, B-coded, for SSI/Interbus, axial connector, open cable end, cable length 2m	50104172
KB SSI/BS-5000-BA	M12 socket, B-coded, for SSI/Interbus, axial connector, open cable end, cable length 5m	50104171
KB SSI/BS-10000-BA	M12 socket, B-coded, for SSI/Interbus, axial connector, open cable end, cable length 10m	50104170
KB SSI/BS-15000-BA	M12 socket, B-coded, for SSI/Interbus, axial connector, open cable end, cable length 15m	50104169
KB SSI/BS-20000-BA	M12 socket, B-coded, for SSI/Interbus, axial connector, open cable end, cable length 20m	50104168
KB SSI/BS-25000-BA	M12 socket, B-coded, for SSI/Interbus, axial connector, open cable end, cable length 25m	50108447
KB SSI/BS-30000-BA	M12 socket, B-coded, for SSI/Interbus, axial connector, open cable end, cable length 30m	50108446

13 Maintenance

13.1 General maintenance information

With normal use, the laser measurement system does not require any maintenance by the operator.

Cleaning

In the event of dust build-up or if the (ATT) warning message is displayed, clean the device with a soft cloth; use a cleaning agent (commercially available glass cleaner) if necessary. Also check the reflector for possible soiling.



Attention!

Do not use solvents and cleaning agents containing acetone. Use of such solvents could blur the reflector, the housing window and the display.

13.2 Repairs, servicing



Attention!

Access to or changes on the device, except where expressly described in this operating manual, are not authorized. The device must not be opened. Failure to comply will render the guarantee void. Warranted features cannot be guaranteed after the device has been opened.

Repairs to the device must only be carried out by the manufacturer.

 *Contact your Leuze distributor or service organization should repairs be required. The addresses can be found on the inside of the cover and on the back.*



Notice!

When sending the laser measurement systems to Leuze electronic for repair, please provide an accurate description of the error.

13.3 Disassembling, packing, disposing

Repacking

For later reuse, the device is to be packed so that it is protected.

Notice!

Electrical scrap is a special waste product! Observe the locally applicable regulations regarding disposal of the product.

A

Accessories 111
 Accessory deflector unit 112
 Accessory mounting bracket 112
 Accessory ready-made cables 113
 Accuracy 14
 Activation 76
 Air humidity 15
 Alignment 20
 ATT 80
 Average 86

C

Cleaning 118
 Commissioning and configuration 59
 Configuration steps 61
 Conformance Classes 60
 Connections
 PROFINET BUS IN 38
 PROFINET BUS OUT 39
 PWR IN 38
 Service 39
 SSI 39
 Control 69, 80
 Control buttons 45
 Control panel 41
 Count direction 72

D

Declaration of conformity 5
 Deflector unit
 Maximum ranges 24
 With integrated mounting bracket 24
 Without mounting bracket 26
 Deflector unit US 1 OMS
 Dimensioned drawing 26
 Deflector unit US AMS 01
 Dimensioned drawing 25
 Description of functions 6
 Device naming 64, 65
 Diagnostics 105
 Dimensioned drawing of AMS 3xxi 16
 Direction selection 87, 89
 Display 41
 Contrast 98

 Illumination 98, 99
 Dynamic velocity comparison 94
 Dynamic velocity limit value status 93

E

Electrical connection 37
 Safety notices 37
 ERR 80
 Error delay (position) 84
 Error delay (velocity) 85
 Error delay time (position) 84
 Error delay time (velocity) 85
 Error handling procedures 69, 84
 Event-related diagnostics 105
 Expanded diagnostics 107
 Explanation of symbols 5

F

Fast commissioning 12
 Flashing of the participant 66
 Free resolution 99
 Function 76

G

General causes of errors 108
 GSD file 61, 67
 GSD modules 69

H

Hardware 80
 Heated reflectors
 Dimensioned drawing 31
 Specifications 30
 Heating control 98

I

I/O 1 69
 I/O 2 69
 Identification & Maintenance Functions 55
 Input 77
 Input/output
 IO 1 76

IO 2	78
Installation	18
Intensity	80
Interface errors	109
Interface info in display	42
Internal hardware error	42

L

Language selection	98
Laser	80
Laser status	80
Limit value 1 range end	88
Limit value 1 range start	88
Lower position limit value	80
LSR	80
LSR status display	110

M

MAC ID	64
Main menu	
Device information	46
Language selection	47
Network information	46
Parameter	47
Service	47
Maintenance	118
Maximum position value	69, 72, 73
Measurement range	14
Measurement unit	72
Measurement value output	14
Menus	
Language selection menu	52
Main menu	46
Parameter menu	48
Service menu	52
Mounting	19
with laser beam deflector unit	24
Mounting bracket(optional)	21
Movement status	93

N

Name plates	18
Network operation	13

O

Offset	72
Operating principle	12
Operating temperature	15
Operation	41, 53
Output	76, 77
Overview of reflector types	112

P

Packaging	18
Parallel mounting	22
Parameter enabling	53, 54
Parameter menu	
I/O	50
Maximum position value	49
Other	51
Parameter handling	48
PROFINET	48
SSI	49
Password	98
Plausibility	80
Plausibility error	42
PLB	80
Position limit value	82, 83
Position limit value 1	69
Position limit value 2	69
Position value in the case of error	84
Prefailure message	42
Preset	74, 75
Dynamic	69, 75
Static	69, 74
Preset reset	75
Preset status	80
Preset teach	75, 80
PROFINET	
Cable lengths and shielding	57
Linear topology	56
Star topology	55
Wiring	56
PROFINET communication profile	59
PROFINET interface	55
PWR LED	43
Q	
Quality assurance	5

R

Received signal 42
 Reflective tape
 Dimensioned drawing 29
 Specifications 28
 Reflector 27
 Mounting 33
 Pitch 36
 Size 32
 Type overview 32
 Repair 118
 Reserved 80
 Resolution 72

S

Sensing distance 111
 Servicing 118
 Siemens Simatic S7 control 61
 Sign 72
 Specifications 14
 Dimensioned drawing 16
 General specifications 14
 Reflective tapes 27
 SSI 100
 Default settings 103, 104
 Electrical connection 102
 SSI interface 70, 95
 Stand-alone operation 13
 State-related diagnostics 105
 Status 69, 80
 Status and measurement data - main menu 47
 Status- and warning messages 41
 Status display 41
 ATT 110
 ERR 110
 PLB 109
 TMP 110
 Status display in the display 109
 Status displays 43
 Status messages 106
 Storage 18
 Storage temperature 15
 Supply voltage 14
 Suppress position status 84
 Suppress velocity status 84
 Surface reflections 34
 Switching mode 87, 89
 Symbols 5

T

Temperature 80
 Temperature monitoring 42
 TMP 80
 Transport 18
 Troubleshooting 105
 Type overview 111

U

Upper position limit value 80

V

Velocity 69, 85, 86
 Dynamic limit value 70, 92
 Limit value 1 69, 87
 Limit value 2 70, 89
 Limit value 3 70, 90
 Limit value 4 70, 91
 Status 70, 93
 Velocity comparison limit value 1 93
 Velocity comparison limit value 2 94
 Velocity comparison limit value 3 94
 Velocity comparison limit value 4 94
 Velocity hysteresis 87, 89
 Velocity in the case of error 84
 Velocity limit value 87, 89
 Velocity limit value status 1 93
 Velocity limit value status 2 93
 Velocity limit value status 3 93
 Velocity limit value status 4 93
 Velocity measurement error 93
 Velocity resolution 86

W

Waving of the participant 66

Level 1	Level 2	Level 3	Level 4	Level 5	Selection/configuration option	Detailed information on	
: selection	: selection : back	: selection : back	: selection : back	: selection : back	: selection : activate : back		
Device information						page 46	
Network information						page 46	
Status and measurement data						page 46	
Parameter	Parameter handling	Parameter enabling			ON / OFF	page 48	
		Password	Activate password		ON / OFF		
			Password entry		Configuration option of a four-digit numerical password		
		Parameters to default		All parameters are reset to their factory settings			
	PROFINET	Activation			ON / OFF	page 48	
	SSI	Activation				ON / OFF	page 49
		Coding				Binary/gray	
		Number of data bits				24-bit/25-bit/26-bit	
		SSI resolution				0.001 mm / 0.01 mm / 0.1 mm / 1 mm / 10 mm / free resolution	
		Error bit				ON / OFF	
		Error bit function				Overflow, intensity (ATT) temp. (TMP) laser (LSR) plausibility (PLB) hardware (ERR)	
		Clock frequency				80kHz - 800kHz, 20us / 50kHz - 79kHz, monoflop time 30us	
	Maximum position value	Measurement unit				Metric/Inch	page 49
		Count direction				Positive/Negative	
		Offset				Value input	
		Preset				Value input	
		Error delay				ON / OFF	
		Position value in the case of error				Last valid value / zero	
		Free resolution value				5 ... 50000	
	I/O	I/O 1	Port configuration			Input/Output	page 50
Switching input			Function		No function/preset teach/laser ON/OFF		
			Activation		Low active/High active		
Switching output			Function		Pos. limit value 1 / Pos. limit value 2 / Velocity / Intensity (ATT) / Temp. (TMP) / Laser (LSR) / Plausibility (PLB) / Hardware (ERR)		
			Activation		Low active/High active		
I/O 2			Port configuration			Input/Output	
Switching input		Function		No function/preset teach/laser ON/OFF			
		Activation		Low active/High active			
Switching output		Function		Pos. limit value 1 / Pos. limit value 2 / Velocity / Intensity (ATT) / Temp. (TMP) / Laser (LSR) / Plausibility (PLB) / Hardware (ERR)			
	Activation		Low active/High active				

	↔	Limit values	↔	Upper pos. limit 1	↔	Activation	ON / OFF	
					↔	Limit value input	Value input in mm or inch/100	
			↔	Lower pos. limit 1	↔	Activation	ON / OFF	
					↔	Limit value input	Value input in mm or inch/100	
			↔	Upper pos. limit 2	↔	Activation	ON / OFF	
					↔	Limit value input	Value input in mm or inch/100	
			↔	Lower pos. limit 2	↔	Activation	ON / OFF	
					↔	Limit value input	Value input in mm or inch/100	
↔	Other	↔	Heating control				Standard/extended (10° C ... 15° C/30° C ... 35° C)	page 51
		↔	Display background				10 minutes/ON	
		↔	Display contrast				Weak/Medium/Strong	
		↔	Service RS232	↔	Baud rate		57.6 kbit/s / 115.2 kbit/s	
				↔	Format		8,e,1 / 8,n,1	
↔	Language selection	↔					Deutsch / English / Español / Français / Italiano	page 52
↔	Service	↔	Status messages				Number of readings, reading gates, reading rate / non-reading rate etc.	page 52
		↔	Diagnostics				Exclusively for service purposes by Leuze electronic	
		↔	Expanded diagnostics				Exclusively for service purposes by Leuze electronic	