

PRK 3B Retro-reflective photoelectric sensors with polarization filter for bottles

en 05-2013/08 50103461

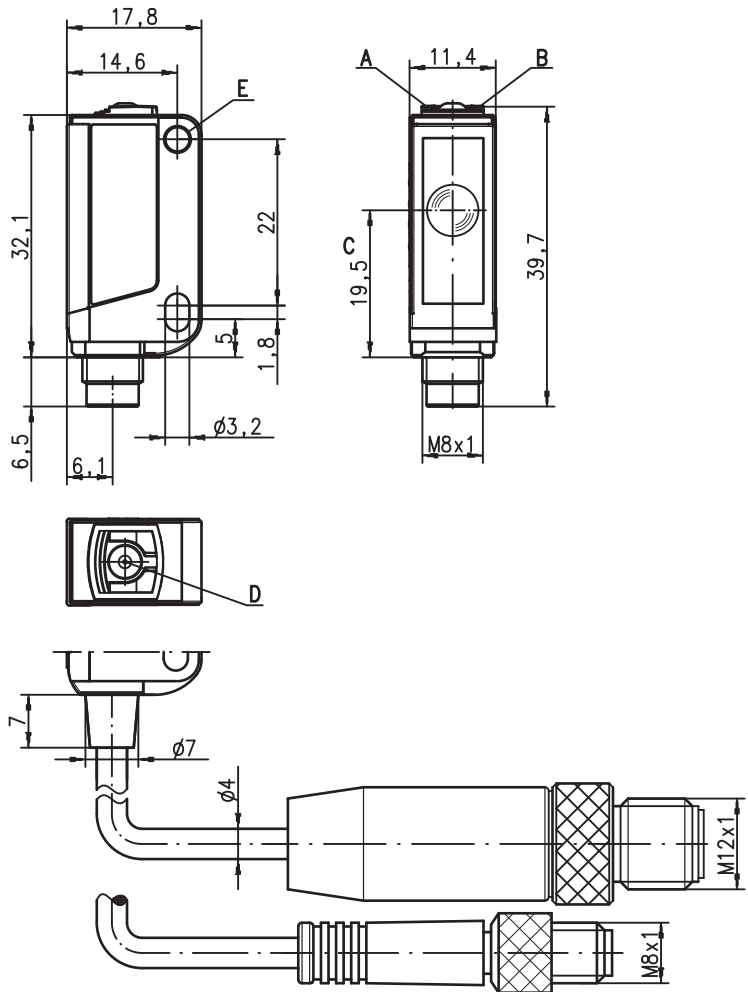

Dimensioned drawing



- A Green indicator diode
- B Yellow indicator diode
- C Optical axis
- D Teach button
- E Mounting sleeve

0 ... 3.5m
1 kHz
T_i
10 - 30 V DC
SPS
PLC

- Polarized retro-reflective photoelectric sensor, autocollimation optics with visible red light
- Particularly suited for highly transparent bottles (PET and glass)
- Small and compact construction with robust plastic housing, protection class IP 67 for industrial application
- Push-pull output with light/dark switching via teach-in button
- High switching frequency for detection of fast events
- Easy adjustment via lockable teach button or teach input

Electrical connection

Plug connector, 4-pin

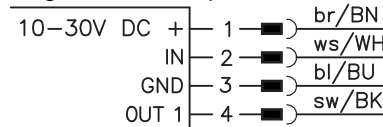

Cable, 4-wire

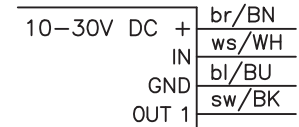

Plug connector, 3-pin

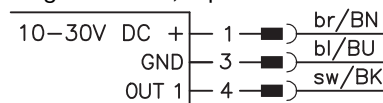

Accessories:

(available separately)

- Mounting systems (BT 3...)
- Cables with M8 or M12 connector (K-D ...)
- Reflectors
- Reflective tapes

We reserve the right to make changes • DS_PRK3B42_en_50103461.fm

Specifications

Optical data

Typ. operating range limit (TK(S) 100x100) ¹⁾ 0 ... 3.5m
 Operating range ²⁾ see tables
 Light source ³⁾ LED (modulated light)
 Wavelength 620nm (visible red light, polarized)

Timing

Switching frequency 1,000Hz
 Response time 0.5ms
 Delay before start-up ≤ 300ms

Electrical data

Operating voltage U_B ⁴⁾ 10 ... 30VDC (incl. residual ripple)
 Residual ripple ≤ 15% of U_B
 Open-circuit current ≤ 18mA
 Switching output ⁵⁾ .../6.42 1 push-pull switching output
 pin 4: PNP light switching, NPN dark switching
 pin 2: teach input
 .../6D.42 1 push-pull switching output
 pin 4: PNP dark switching, NPN light switching
 pin 2: teach input
 .../6.42...-S8.3 1 push-pull switching output
 pin 4: PNP light switching, NPN dark switching
 pin 2: teach input
 .../4D.42 1 PNP switching output, dark switching,
 pin 2: teach input
 light/dark reversible
 Signal voltage high/low ≥ ($U_B - 2V$)/≤ 2V
 Output current max. 100mA
 Operating range setting via teach-in

Indicators

Green LED ready
 Yellow LED light path free

Mechanical data

Housing ⁶⁾ plastic (PC-ABS); 1 attachment sleeve, nickel-plated steel
 Optics cover plastic (PMMA)
 Weight with connector: 10g
 with 200mm cable and connector: 20g
 with 2m cable: 50g
 Connection type 2m or 5m cable (cross section 4x0.20mm²),
 connector M8 metal,
 0.2m cable with connector M8 or M12

Environmental data

Ambient temp. (operation/storage) -30°C ... +55°C/-30°C ... +70°C
 Protective circuit ⁷⁾ 2, 3
 VDE safety class III
 Protection class IP 67
 Light source fee group (in acc. with EN 62471)
 Standards applied IEC 60947-5-2
 Certifications UL 508 ⁴⁾

Options

Teach-in input/activation input
 Transmitter active/not active ≥ 8V/≤ 2V
 Activation/disable delay ≤ 1ms
 Input resistance 30kΩ

- 1) Typ. operating range limit: max. attainable range without performance reserve
- 2) Operating range: recommended range with performance reserve
- 3) Average life expectancy 100,000h at an ambient temperature of 25°C
- 4) For UL applications: for use in class 2 circuits according to NEC only
- 5) The push-pull switching outputs must not be connected in parallel
- 6) Patent Pending Publ. No. US 7,476,848 B2
- 7) 2=polarity reversal protection, 3=short circuit protection for all transistor outputs

Remarks

- The light spot may not exceed the reflector.
- Preferably use MTK(S) or tape 6.
- For foil 6, the sensor's side edge must be aligned parallel to the side edge of the reflective tape.
- Adapter plate: BT 3.2 (part no. 50103844) for alternate mounting on 25.4mm hole spacing (Omron E3Z, Sick W100...)

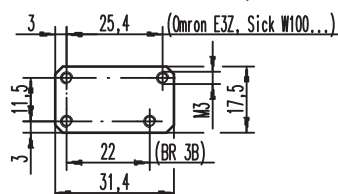

Tables

Reflectors			Operating range	
1	TK(S)	100x100	0 ... 3.0m	
2	TK	40x60	0 ... 2.0m	
3	MTKS	50x50.1	0 ... 1.3m	
4	Tape 6	50x50	0 ... 1.2m	
5	TK	20x40	0 ... 1.0m	

1	0		3	3.6
2	0	2.0	2.4	
3	0	1.3	1.6	
4	0	1.2	1.4	
5	0	1.0	1.2	

□ Operating range [m]
 ▒ Typ. operating range limit [m]

TK ... = adhesive
 TKS ... = screw type

Diagrams

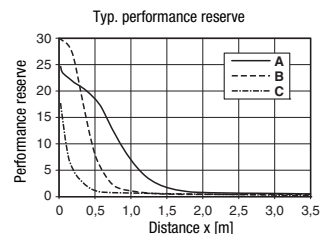
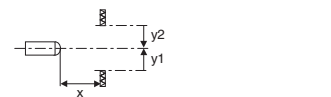
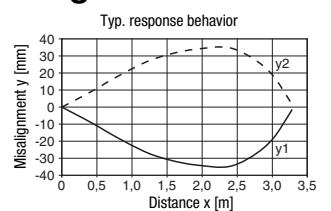

- A TKS 40x60
- B TKS 20x40
- C Tape 4: 50x50

Remarks

Mounting system:



- ① = BT 3 (part no. 50060511)
- ②+③ = BT 3.1 ¹⁾ (part no. 50105585)
- ①+②+③ = BT 3B (part no. 50105546)

1) Packaging unit: PU = 10 pcs.

PRK 3B Retro-reflective photoelectric sensors with polarization filter for bottles

Order guide

Selection table		Order code →					
Equipment ↓		PRK 3B/6.42-S8 Part No. 50112473	PRK 3B/6.42, 200-S12 on request	PRK 3B/6D.42-S8 Part No. 50112474	PRK 3B/6D.42, 200-S12 on request	PRK 3B/6.42 on request	PRK 3B/6.42, 5000 Part No. 50114873
Switching output	1 x push-pull switching output	●	●	●	●	●	●
Switching function	light switching	●	●			●	●
	dark switching			●	●		
	light/dark switching configurable	●	●	●	●	●	●
Connection	M8 connector, metal, 4-pin	●		●			
	M8 connector, metal, 3-pin						
	cable 200mm with M12 connector, 4-pin		●		●		
	2000mm cable, 4-wire					●	
	cable 5000mm, 4-wire						●
Configuration	teach-in via button (lockable) and teach input ¹⁾	●	●	●	●	●	●
Indicators	green LED: ready + teach sequence	●	●	●	●	●	●
	yellow LED: switching output	●	●	●	●	●	●
Detection	foils < 20µm thick						
	foils > 20µm thick	●	●	●	●	●	●
	bottles (PET and glass)	●	●	●	●	●	●

1) Teach input not present with 3-pin connector

● **Approved purpose:**

This product may only be used by qualified personnel and must only be used for the approved purpose. This sensor is not a safety sensor and is not to be used for the protection of persons.

Sensor adjustment (teach) via teach button



- **The sensor is factory-adjusted for maximum operating range.**
Recommendation: teach only if the desired objects are not reliably detected.
- **Prior to teaching:**
Clear the light path to the reflector!
The device setting is stored in a fail-safe way. A reconfiguration following voltage interruption or switch-off is thus not required.

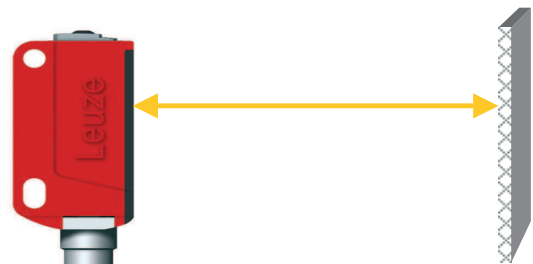

Teach for 11% sensor sensitivity (highly transparent bottles and foils with thickness > 20µm)

- Press teach button until both LEDs flash **simultaneously**.
- Release teach button.
- Ready.



After the teaching, the sensor switches when about 11 % of the light beam are covered by the object.

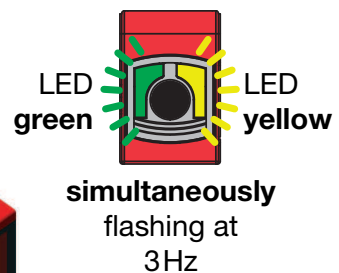
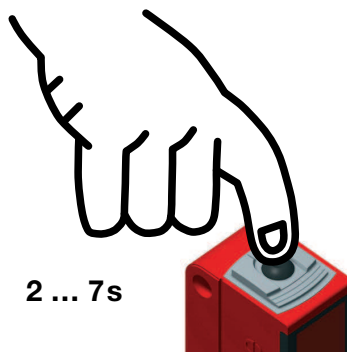

Teach for 18% sensor sensitivity (standard bottles)

- Press teach button until both LEDs flash **alternatingly**.
- Release teach button.
- Ready.



After the teaching, the sensor switches when about 18% of the light beam are covered by the object.

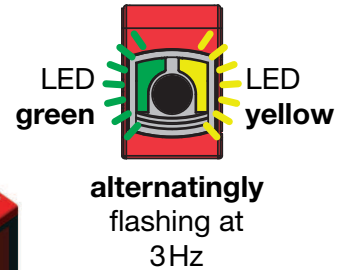
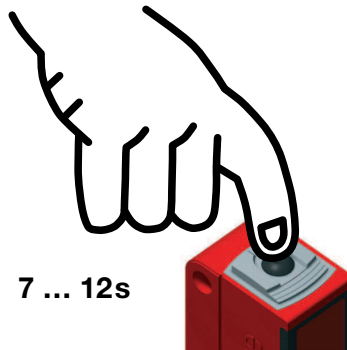

Teaching for maximum operating range (factory setting at delivery)

- Prior to teaching: **Cover the light path to the reflector!**
- Press teach button until both LEDs flash **simultaneously**.
- Release teach button.
- Ready.

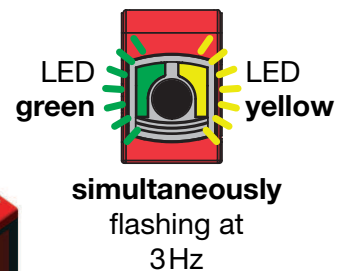
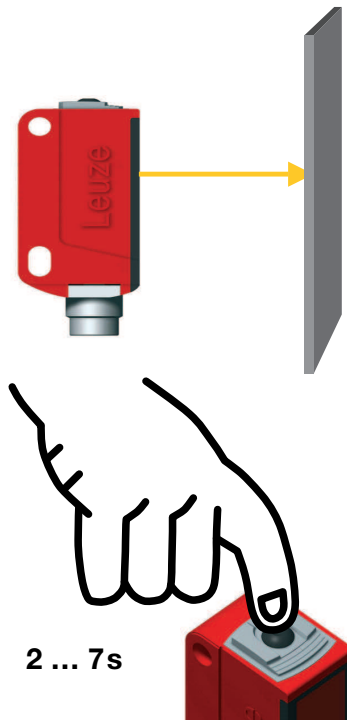

Adjusting the switching behavior of the switching output – light/dark switching

- Press teach button until the green LED flashes. The yellow LED displays the current setting of the switching output:
ON = output switches on light
OFF = output switches on dark
- Continue to press the teach button in order to change the switching behavior.
- Release teach button.
- Ready.

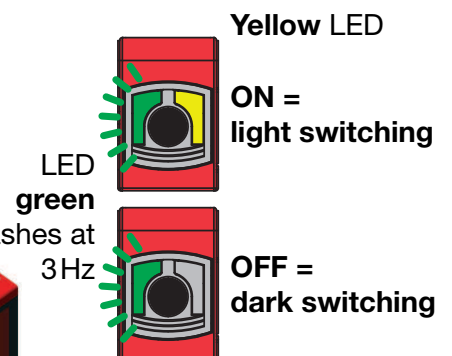
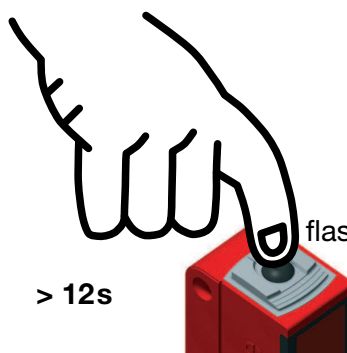

PRK 3B Retro-reflective photoelectric sensors with polarization filter for bottles

Locking the teach button via the teach input



A **static HIGH signal** ($\geq 4\text{ms}$) at the teach input locks the teach button on the device if required, such that no manual operation is possible (e.g., protection from erroneous operation or manipulation).

If the teach input is not connected or if there is a static low signal, the button is unlocked and can be operated freely.

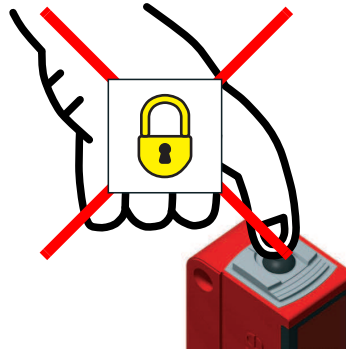

Sensor adjustment (teach) via teach input



The following description applies to PNP switching logic!

$U_{\text{Teach low}} \leq 2\text{V}$

$U_{\text{Teach high}} \geq (U_B - 2\text{V})$

Prior to teaching: Clear the light path to the reflector!

The device setting is stored in a fail-safe way. A reconfiguration following voltage interruption or switch-off is thus not required.

Teach for 11% sensor sensitivity
(highly transparent bottles and foils with thickness > 20µm)

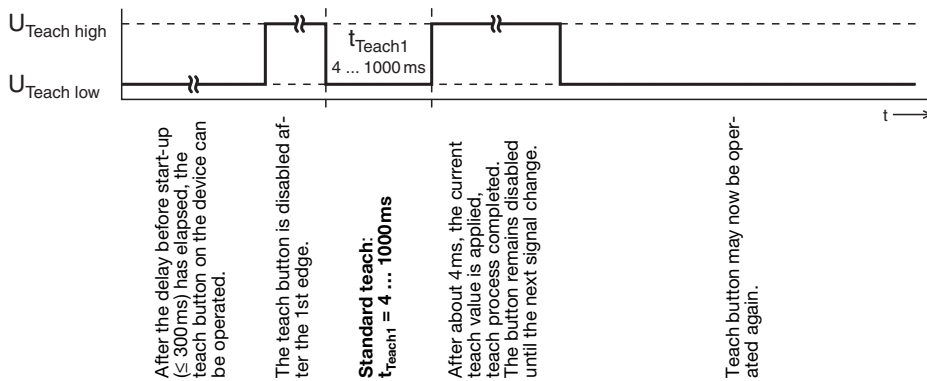

Quick teach for 11% sensor sensitivity
(highly transparent bottles and foils with thickness > 20µm)

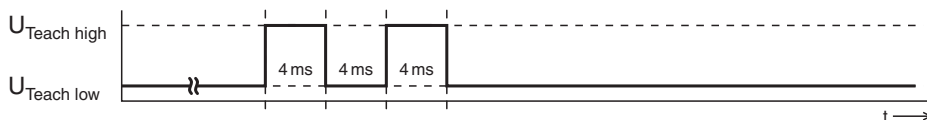

Shortest teaching duration for this teaching: approx. 12ms



After the teaching, the sensor switches when about 11% of the light beam are covered by the object.

Teach for 18% sensor sensitivity (standard bottles)

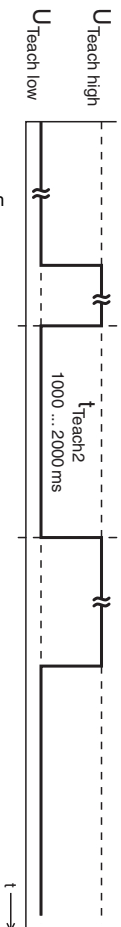

After the delay before start-up (≤ 300 ms) has elapsed, the teach button on the device can be operated.

The teach button is disabled after the 1st edge.

Teach for increased sensor sensitivity:
 $t_{\text{Teach2}} = 1000 \dots 2000$ ms

After about 4ms, the current teach value is applied, teach process completed. The button remains disabled until the next signal change.

Teach button may now be operated again.



After the teaching, the sensor switches when about 18% of the light beam are covered by the object.

Adjusting the switching behavior of the switching output – light/dark switching

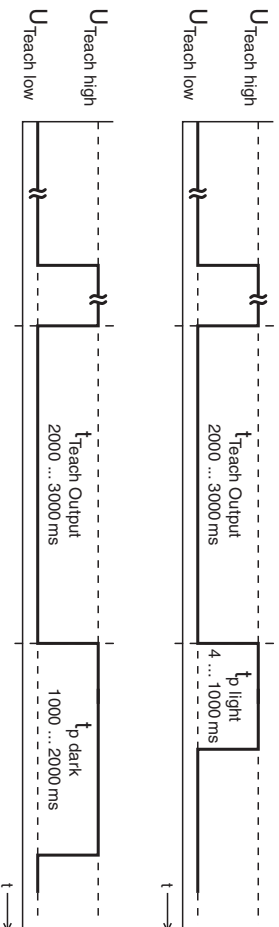

After the delay before start-up (≤ 300 ms) has elapsed, the teach button on the device can be operated.

The teach button is disabled after the 1st edge.

Setting the switching behavior of the switching output:

$t_{\text{Teach Output}} = 2000 \dots 3000$ ms

Switching output switches on light:

$t_{p \text{ light}} = 4 \dots 1000$ ms

Switching output switches on dark:

$t_{p \text{ dark}} = 1000 \dots 2000$ ms

The button remains disabled until the next signal change.