

**L46CI Infrared throughbeam photoelectric sensor with alignment indicator**

en 01 - 2015/0650129627



**150m**



- Throughbeam photoelectric sensor with large operating range and extremely high function reserve in infrared version for use under rough environmental conditions
- Sensitivity adjustment and delay before start-up for optimal adaptation to the application
- Time-saving, exact alignment and function check through additional, highly visible display on front side
- Warning output for sustained availability (preailure message)
- Activation input for sensor test
- Various switching output functions for universal connection to existing control environment
- Robust plastic housing in degrees of protection IP67 and IP69K



**Accessories:**

(available separately)

- Mounting systems (BT 46, BTU 300M, BT 300, BTU 346)
- M12 connectors (KD ...)
- Ready-made cables (K-D ...)
- Alignment aid (SAT 5)
- Laser alignment aid (ARH 46C)

**Dimensioned drawing**

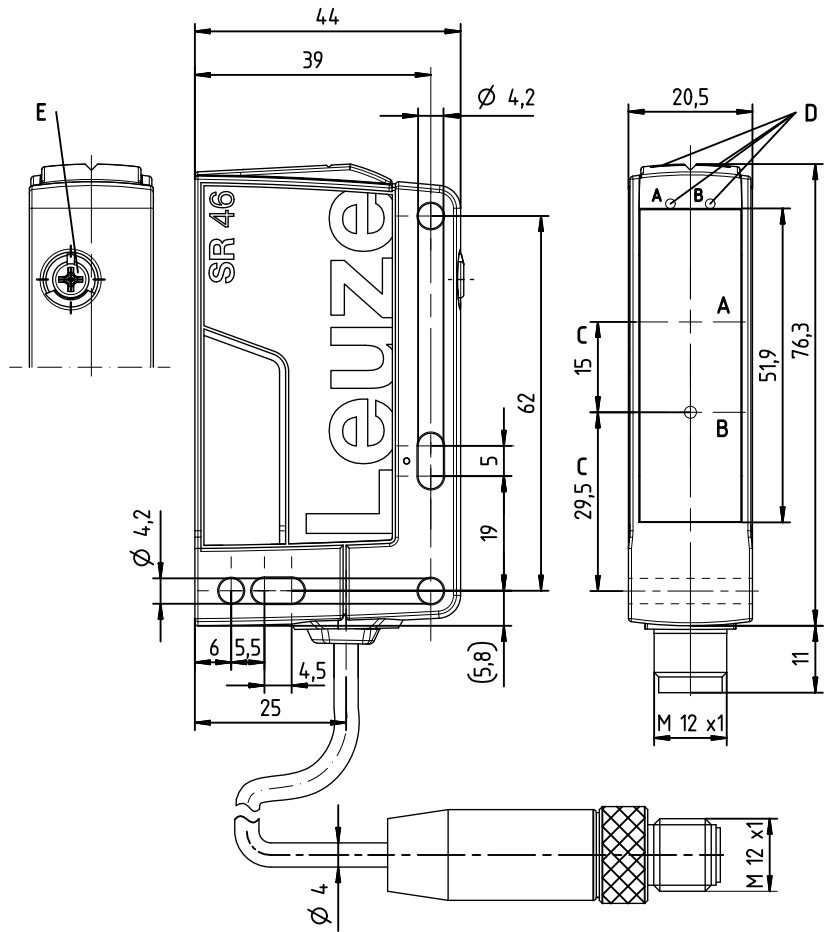

- A** Transmitter (LS) / Receiver (LE)
- B** Yellow indicator diode Transmitter: active/not active Receiver: signal/no signal
- C** Optical axis
- D<sub>A</sub>** Green indicator diode
- D<sub>B</sub>** Yellow indicator diode
- E** Sensitivity adjustment (only on receiver)

**Electrical connection**

Transmitter, 4-pin connector

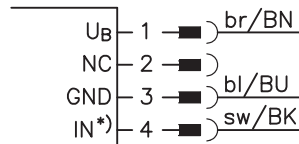

Receiver, 4-pin connector

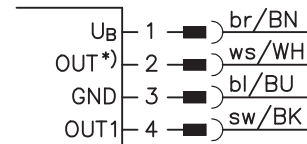

Transmitter, cable

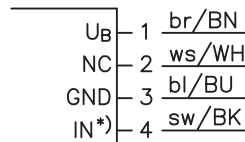

Receiver, cable

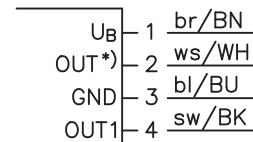

Selection pin 2/4

*)	OUT	IN
	OUT 2	Active
	Warn	NC
	NC	

We reserve the right to make changes • DS\_L46CI\_en\_50129627.fm

## Specifications

### Optical data

Typ. operating range limit <sup>1)</sup>	0 ... 150m
Operating range <sup>2)</sup>	0.5 ... 120m
Operating range adjustment	225° potentiometer (LE46CI.1... only)
Light source <sup>3)</sup>	LED (modulated light)
Wavelength	860nm (infrared light)

### Timing

Switching frequency	500Hz
Response time	1 ms
Delay before start-up	≤ 300ms

### Electrical data

#### With transistor switching outputs

Operating voltage $U_B$ <sup>4)</sup>	10 ... 30VDC (incl. residual ripple)
Residual ripple	≤ 15% of $U_B$
Open-circuit current	≤ 20mA
Switching outputs/functions <sup>5)</sup>	/4P 2 PNP switching outputs, antivalent
	/4X 1 PNP switching output, light switching
	/PX 1 PNP switching output, dark switching
	/2N 2 NPN switching outputs, antivalent
Signal voltage high/low	$\geq (U_B - 2V) / \leq 2V$
Output current	max. 100mA

### Indicators

Green LED	ready
Yellow LED	light path free
Yellow LED, flashing	light path free, no function reserve
Yellow LED (behind lens cover)	transmitter: active/not active
	receiver: signal/no signal
Yellow LED (behind lens cover), flashing	receiver: signal, performance reserve limited

### Mechanical data

Housing	plastic	
Optics cover	plastic	
Weight	with M12 connector: with 200mm cable and M12 connector: with 2000mm cable:	approx. 60g approx. 65g approx. 100g
Connection type	M12 connector, 4-pin cable 200mm with M12 connector, 4-pin cable 2000mm, 4 x 0.21 mm <sup>2</sup>	

### Environmental data

Ambient temp. (operation/storage)	-40°C ... +60°C / -40°C ... +70°C
Protective circuit <sup>6)</sup>	1, 2, 3
VDE safety class <sup>7)</sup>	II, all-insulated
Degree of protection	IP 67, IP 69K <sup>8)</sup>
Light source	exempt group (in acc. with EN 62471)
Standards applied	IEC 60947-5-2
Certifications	UL 508, CSA C22.2 No.14-13 <sup>4) 9)</sup>

### Options

<b>Warning output</b>	PNP transistor, counting principle
Signal voltage high/low	$\geq (U_B - 2V) / \leq 2V$
Output current	max. 100mA
<b>Activation input</b>	
Transmitter active/not active	$\geq 8V / \leq 2V$
Activation/disable delay	≤ 1ms
Input resistance	10KΩ ± 10%

- 1) Typ. operating range limit: max. attainable range without function reserve
- 2) Operating range: recommended range with function reserve
- 3) Average life expectancy 100,000 h at an ambient temperature of 25°C
- 4) For UL applications: for use in class 2 circuits only
- 5) See part number code
- 6) 1=transient protection, 2=polarity reversal protection, 3=short circuit protection for all outputs
- 7) Rating voltage 250VAC
- 8) IP 69K test acc. to DIN 40050 part 9 simulated, high pressure cleaning conditions without the use of additives, acids and bases are not part of the test
- 9) These proximity switches shall be used with UL Listed Cable assemblies rated 30V, 0.5A min, in the field installation, or equivalent (categories: CYJV/CYJV7 or PVVA/PVVA7)

## Tables

0	0.5	120	150
---	-----	-----	-----

	Operating range [m]
	Typ. operating range limit [m]

## Diagrams

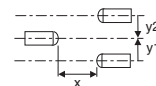
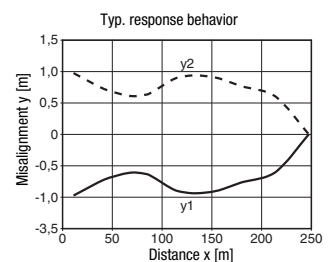

## Remarks

### Operate in accordance with intended use!

- ⚠ This product is not a safety sensor and is not intended as personnel protection.
- ⚠ The product may only be put into operation by competent persons.
- ⚠ Only use the product in accordance with the intended use.

- A light axis consists of a transmitter and a receiver with the following designations:

L46C... = complete light axis  
LS46C... = transmitter  
LE46C... = receiver

- **Alignment indicator:** ('B' see dimensioned drawing)

**Yellow LED =**  
light path free - with reserve

**Yellow LED, flashing =**  
light path free - no function reserve

# L46CI Infrared throughbeam photoelectric sensor with alignment indicator

## Part number code

L	S	4	6	C	I	.	8					-	2	0	0	-	M	1	2
L	E	4	6	C	I	.	1	/	4	P		-	2	0	0	-	M	1	2

### Operating principle

**LS** Throughbeam photoelectric sensor, transmitter  
**LE** Throughbeam photoelectric sensor, receiver

### Series

**46C** 46C series

### Light type

**Free** Red light  
**I** Infrared light

### Equipment

**1** Sensitivity adjustment via potentiometer on receiver  
**8** Activation input on transmitter (active high, connector pin 4/black cable wire)

### Pin assignment of OUT1 (connector pin 4 / black cable wire)

**2** NPN, light switching  
**N** NPN, dark switching  
**4** PNP, light switching  
**P** PNP, dark switching

### Pin assignment of OUT2 (connector pin 2 / white cable wire)

**X** Not assigned  
**2** NPN, light switching  
**N** NPN, dark switching  
**4** PNP, light switching  
**P** PNP, dark switching  
**W** Warning output, PNP, light switching

### Connection technology

**M12** M12 connector, 4-pin  
**200-M12** Cable 200 mm with M12 connector, 4-pin  
**Free** Cable 2000 mm

## Order guide

The sensors listed here are preferred types; current information at [www.leuze.com](http://www.leuze.com).

<b>Red-light throughbeam photoelectric sensor with alignment display</b>		<b>Designation</b>	<b>Part no.</b>
<b>TRANSMITTER</b>	<b>With M12 connector, 4-pin</b>		
	Standard	LS46CI-M12	50127046
	<b>Cable 0.2m with M12 connector, 4-pin</b>		
	<b>Cable 2m</b>		
<b>RECEIVER</b>	<b>With M12 connector, 4-pin</b>		
	OUT1: PNP light switching; OUT2: PNP dark switching; sensitivity adjustment	LE46CI.1/4P-M12	50127040
	<b>Cable 0.2m with M12 connector, 4-pin</b>		
	<b>Cable 2m</b>		

For a complete light axis, arbitrary combinations of the transmitters and receivers listed above are possible.