

HRTL 46B Ex n Laser diffuse reflection light scanner with background suppression

en 02-2014/06 50123270-01

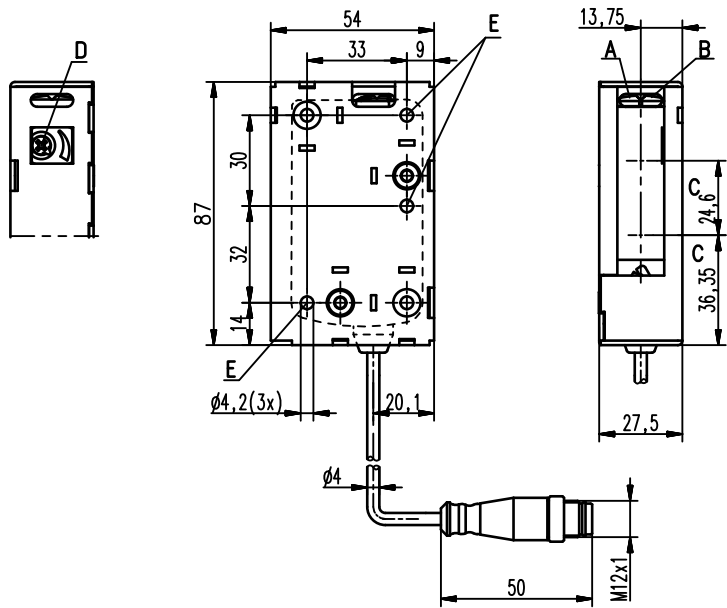

Dimensioned drawing



- A** Green indicator diode
- B** Yellow indicator diode
- C** Optical axis
- D** Scanning range adjustment
- E** Fastening hole

Electrical connection

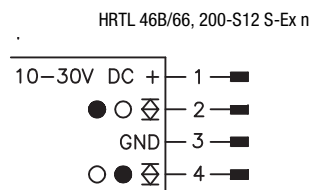

50 ... 1,200mm
800mm with
black-white error < 10%



- Adjustable scanner with background suppression
- Exact positioning and detection of small parts by means of a laser beam
- Exact scanning range adjustment through multiturn potentiometer
- Fast alignment through *brightVision*®
- High switching frequency for detection of fast events
- A²LS - Active Ambient Light Suppression
- Complementary switching outputs for optimal adaptation to the application
- Activation for e.g. muting or test function
- Ex II 3G Ex nA op is IIB T4 Gc X
- Ex II 3D Ex tc IIIC T90°C Dc IP67 X

We reserve the right to make changes • DS_HRTL46BEx_en_50123270_01.fm



Accessories:

- (available separately)
- Mounting systems (BT 46, BT 46.1, BT 46.1.5, BT 46.2)
 - M12 connectors (KD ...)
 - Ready-made cables (K-D ...)

Specifications

Optical data

Typ. scanning range limit (white 90%) ¹⁾	50 ... 1,200mm
Scanning range ²⁾	see tables
Adjustment range	120 ... 1,200mm
Light source	laser (modulated light)
Wavelength	655 nm (visible red light)
Light spot	approx. 3mm x 5mm at 1,000mm
Max. output power	2.2mW
Pulse duration	13.8µs

Timing

Switching frequency	1,000Hz
Response time	0.5ms
Delay before start-up	≤ 100ms

Electrical data

Operating voltage U_B	10 ... 30VDC (incl. residual ripple)
Residual ripple	≤ 15% of U_B
Open-circuit current	≤ 30mA
Switching output	2 push-pull switching outputs ³⁾
	pin 2: PNP dark switching, NPN light switching
	pin 4: PNP light switching, NPN dark switching
	push-pull switching output ⁴⁾
	pin 4: PNP light switching, NPN dark switching
Signal voltage high/low	≥ ($U_B - 2V$) / ≤ 2V
Output current	max. 100mA

Indicators

Green LED	ready
Yellow LED	reflection
Yellow LED, flashing	reflection, no performance reserve

Mechanical data

Housing	plastic
Optics cover	plastic
Weight	50g (with connector) / 65g (with cable and conn.)
Connection type	M12 connector, or cable with M12 connector, cable length: 200mm

Environmental data

Ambient temp. (operation/storage)	-30°C ... +55°C / -40°C ... +70°C
	-10°C ... +40°C / -40°C ... +70°C ⁴⁾
Protective circuit ⁵⁾	2, 3
VDE safety class ⁶⁾	II, all-insulated
Protection class	IP 67, IP 69K
Laser class	2 in accordance with EN 60825-1:2007
Standards applied	IEC 60947-5-2

Explosion protection

Certification (CENELEC)	⊕ II 3G Ex nA op is IIB T4 Gc X
	⊕ II 3D Ex tc IIIC T90°C Dc IP67 X

Options

Activation input active	
Transmitter active/not active	≥ 8V / ≤ 2V
Activation/disable delay	≤ 1ms / ≤ 2ms
Input resistance	10KΩ ± 10%

- 1) Typ. scan. range limit: max. achievable scanning range for light objects (white 90%)
- 2) Scanning range: recommended scanning range for objects with different diffuse reflection
- 3) The push-pull switching outputs must not be connected in parallel
- 4) Temperature range for UL applications
- 5) 2=polarity reversal protection, 3=short circuit protection for all outputs
- 6) Rating voltage 50V

Order guide

The sensors listed here are preferred types; current information at www.leuze.com.

Cable with M12 connector, length: 200mm	Designation	Part no.
Complementary push-pull switching output		
Housing model S (standard)	HRTL 46B/66, 200-S12 S-Ex n	50114409

Tables

1	50	1,200
2	60	850
3	80	750

1	white 90%
2	gray 18%
3	black 6%

Scanning range [mm]

Diagrams

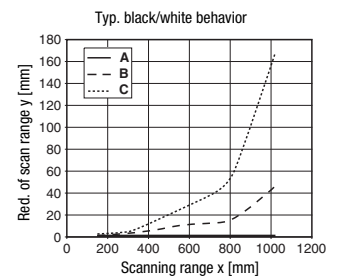

- A white 90%
- B gray 18%
- C black 6%

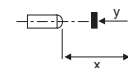

Remarks

Operate in accordance with intended use!

- ⚠ This product is not a safety sensor and is not intended as personnel protection.
- ⚠ The product may only be put into operation by competent persons.
- ⚠ Only use the product in accordance with the intended use.

- With the set scanning range, a tolerance of the upper scanning range limit is possible depending on the reflection properties of the material surface.

HRTL 46B Ex n Laser diffuse reflection light scanner with background suppression

Laser safety notices

 **ATTENTION, LASER RADIATION – LASER CLASS 2**

Never look directly into the beam!

The device fulfills the EN 60825-1:2008-05 (IEC 60825-1:2007) safety regulations for a product in **laser class 2** as well as the U.S. 21 CFR 1040.10 regulations with deviations corresponding to "Laser Notice No. 50" from June 24th, 2007.

- ↳ Never look directly into the laser beam or in the direction of reflecting laser beams!
If you look into the beam path over a longer time period, there is a risk of injury to the retina.
- ↳ Do not point the laser beam of the device at persons!
- ↳ Intercept the laser beam with an opaque, non-reflective object if the laser beam is accidentally directed towards a person.
- ↳ When mounting and aligning the device, avoid reflections of the laser beam off reflective surfaces!
- ↳ **CAUTION!** Use of controls or adjustments or performance of procedures other than specified herein may result in hazardous light exposure.
The use of optical instruments or devices (e.g., magnifying glasses, binoculars) with the product will increase eye hazard.
- ↳ Adhere to the applicable legal and local regulations regarding protection from laser beams acc. to EN 60825 (IEC 60825) in its latest version.
- ↳ The device must not be tampered with and must not be changed in any way.
There are no user-serviceable parts inside the device.
Repairs must only be performed by Leuze electronic GmbH + Co. KG.

NOTICE

Affix laser information and warning signs!

Laser information and warning signs are affixed to the device (see ①). In addition, self-adhesive laser information and warning signs (stick-on labels) are supplied in several languages (see ②).

- ↳ Affix the laser information sheet with the language appropriate for the place of use to the device.
When using the device in the US, use the stick-on label with the "Complies with 21 CFR 1040.10" notice.
- ↳ Affix the laser information and warning signs near the device if no signs are attached to the device (e.g. because the device is too small) or if the attached laser information and warning signs are concealed due to the installation position.
Affix the laser information and warning signs so that they are legible without exposing the reader to the laser radiation of the device or other optical radiation.

①



A Laser exit opening

②

50107357-02

LASERSTRAHLUNG NICHT IN DEN STRAHL Blicken	
Max. Leistung (peak):	2,2 mW
Impulsdauer:	13,8 µs
Wellenlänge:	655 nm
LASER KLASSE 2 DIN EN 60825-1:2008-05	

LASER RADIATION DO NOT STARE INTO BEAM	
Maximum Output (peak):	2.2 mW
Pulse duration:	13.8 µs
Wavelength:	655 nm
CLASS 2 LASER PRODUCT EN 60825-1:2007	

AVOID EXPOSURE – LASER RADIATION
IS EMITTED FROM THIS APERTURE

RADIACION LASER NO MIRAR FIJAMENTE AL HAZ	
Potencia max. (peak):	2,2 mW
Duración del impulso:	13,8 µs
Longitud de onda:	655 nm
PRODUCTO LASER DE CLASE 2 EN 60825-1:2007	

LASER RADIATION DO NOT STARE INTO BEAM	
Maximum Output (peak):	2.2 mW
Pulse duration:	13.8 µs
Wavelength:	655 nm
CLASS 2 LASER PRODUCT EN 60825-1:2007 Complies with 21 CFR 1040.10	

RADIACIÓN LASER NÃO OLHAR FIXAMENTE O FEIXE	
Potência max. (peak):	2,2 mW
Período de pulso:	13,8 µs
Comprimento de onda:	655 nm
EQUIPAMENTO LASER CLASSE 2 EN 60825-1:2007	

激光辐射 勿直视光束	
最大输出 (峰值):	2.2 mW
脉冲持续时间:	13.8 µs
波长:	655 nm
2 类激光产品 GB7247.1-2012	



Notices for the safe use of sensors in potentially explosive areas

This document is valid for devices with the following classifications:

Device group	Device category	Equipment protection level	Zone
II	3G	Gc	Zone 2
II	3D	Dc	Zone 22



Attention!

- Check whether the equipment classification corresponds to the requirements of the application.
- The devices are not suited for the protection of persons and may not be used for emergency shutdown purposes.
- A safe operation is only possible if the equipment is used properly and for its intended purpose.
- Electrical equipment may endanger humans and (where applicable) animal health, and may threaten the safety of goods if used incorrectly or under unfavorable conditions in potentially explosive areas.
- The applicable national regulations (e.g. EN 60079-14) for the configuration and installation of explosion-proof systems must be observed without fail.

Installation and Commissioning

- The devices must only be installed and commissioned by trained electricians. They must be aware of the regulations and operation of explosion-proof equipment.
- To prevent unintentional separation under voltage, devices with connector (e.g. Series 46B) must be equipped with a safeguard or a mechanical interlocking guard (e.g. K-VM12-Ex, part no. 50109217). The warning sign "Do not disconnect under voltage" that is supplied with the device must be attached to the sensor or its mounting bracket so that it is clearly visible.
- Devices with terminal compartment lid (e.g. Series 96) must only be commissioned if the terminal compartment lid of the device is properly sealed.
- Connection cables and connectors must be protected from excessive or unintended pulling or pushing strain.
- Prevent dust deposits from forming on the devices.
- Metallic parts (e.g. housing, mounting devices) are to be integrated into the potential equalization to prevent electrostatic charge.

Maintenance

- No changes may be made to explosion-proof devices.
- Repairs may only be performed by a person trained for such work or by the manufacturer.
- Defective devices must be replaced immediately.
- Cyclical maintenance is generally not necessary.
- Depending on the environmental conditions, it may occasionally be necessary to clean the optical surfaces of the sensors. This cleaning must only be performed by persons trained for this task. We recommend using a soft, damp cloth. Cleaning agents that contain solvents must not be used.

Chemical resistance

- The sensors demonstrate good resistance against diluted (weak) acids and bases.
- Exposure to organic solvents is possible only under certain circumstances and only for short periods of time.
- Resistance to chemicals must be examined on a case by case basis.

Special conditions

- The devices must be installed in such a way that they are protected from direct exposure to UV rays (sunlight).
- Static charge on plastic surfaces must be avoided.

HRTL 46B Ex n Laser diffuse reflection light scanner with background suppression



the **sensor** people

EG-KONFORMITÄTS- ERKLÄRUNG

EC DECLARATION OF CONFORMITY

DECLARATION CE DE CONFORMITE

Der Hersteller

The Manufacturer

Le constructeur

Leuze electronic GmbH + Co. KG
In der Braike 1, PO Box 1111
73277 Owen, Germany

erklärt, dass die nachfolgend
aufgeführten Produkte den
einschlägigen Anforderungen
der genannten EG-Richtlinien
und Normen entsprechen.

declares that the following
listed products fulfil the
relevant provisions of the
mentioned EC Directives and
standards.

déclare que les produits
identifiés suivants sont
conformes aux directives CE
et normes mentionnées.

Produktbeschreibung:

Description of product:

Description de produit:

**Laser-Reflexions-Lichttaster
mit Hintergrundausblendung
HRTL 46B/...S-Ex n**

**Laser diffuse reflection light
scanner with background
suppression
HRTL 46B/... S-Ex n**

**Cellule reflex laser à détection
directe avec élimination de
l'arrière-plan
HRTL 46B/... S-Ex n**

Kennzeichnung Gas / Staub:

Marking for gas / dust:

Marquage gaz / poussière:

 II 3G Ex nA op is IIB T4 Gc X

/  II 3D Ex tc IIIC T90° C Dc IP67 X

Angewandte EG-Richtlinie(n):

Applied EC Directive(s):

Directive(s) CE appliquées:

**94/9/EG
2004/108/EG**

**94/9/EC
2004/108/EC**

**94/9/CE
2004/108/CE**

Angewandte Normen:

Applied standards:

Normes appliquées:

**EN 60079-0: 2009
EN 60079-28: 2007
EN 609478-5-2: 2007**

**EN 60079-15: 2005
EN 60079-31: 2009
EN 60825-1: 2007**

3.6.2013

Datum / Date / Date



Ulrich Balbach, Geschäftsführer / Director / Directeur

Leuze electronic GmbH + Co. KG
In der Braike 1
D-73277 Owen
Telefon +49 (0) 7021 573-0
Telefax +49 (0) 7021 573-199
info@leuze.de
www.leuze.com

LEO-ZQM-149-02-FO

Leuze electronic GmbH + Co. KG, Sitz Owen, Registergericht Stuttgart, HRA 230712
Persönlich haftende Gesellschafterin Leuze electronic Geschäftsführungs-GmbH,
Sitz Owen, Registergericht Stuttgart, HRB 230550

Geschäftsführer: Ulrich Balbach, Dr. Matthias Kirchherr
USt-IdNr. DE 145912521 | Zollnummer 2554232

Es gelten ausschließlich unsere aktuellen Verkaufs- und Lieferbedingungen
Only our current Terms and Conditions of Sale and Delivery shall apply

