

HRTR 25B

Diffuse reflection light scanner with background suppression

en 03-2016/03 50114840

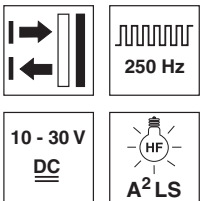

0 ... 1000mm
350mm with
black-white error < 10%

- Visible red light – minimal black-white difference enables exact switching behavior and reliable object detection
- Problem-free mechanical installation – sensor performance with large adjustment range and object detection at minimal distance
- An additional status display on the front side of the sensor makes possible place-saving alignment, optimum scanning range adjustment and rapid function control
- Ultra-simple integration into the existing control environment – large selection of switching outputs, activation input
- Minimal current consumption – reduction of energy consumption in standby operation
- A²LS – Active Ambient Light Suppression

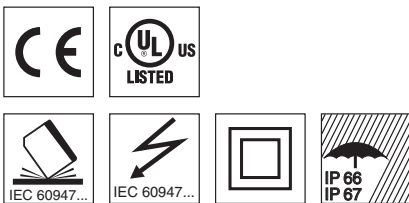

Accessories:

(available separately)

- Mounting systems (BT 25, UMS 25...)
- Cable with M8 or M12 connector (K-D ...)

Dimensioned drawing

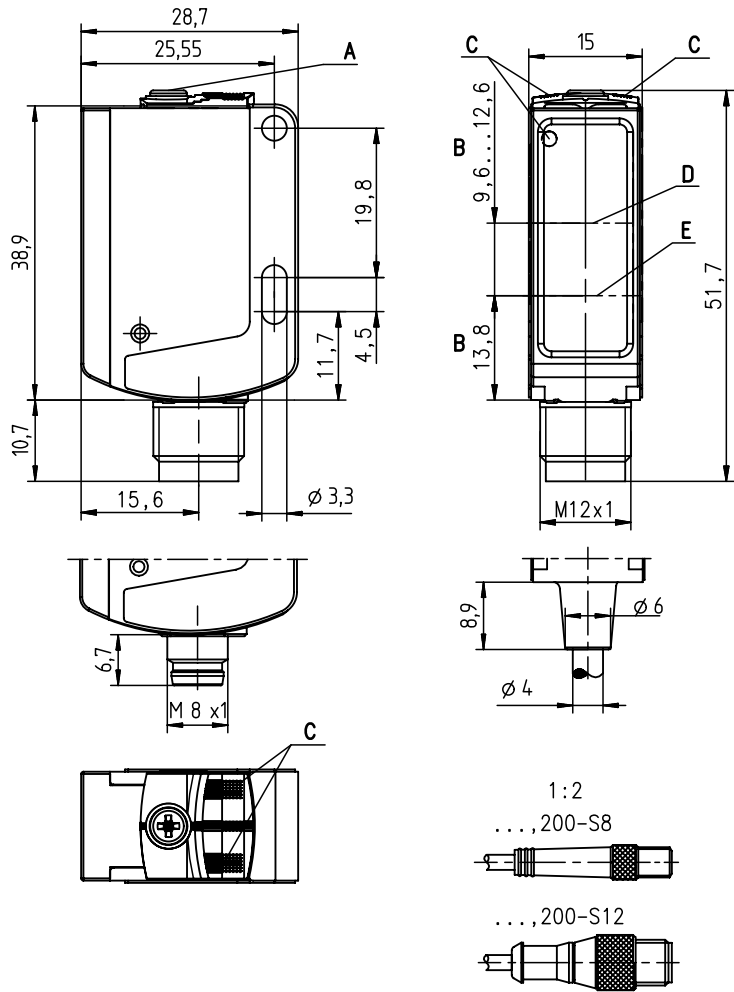

- A** Scanning range adjustment
- B** Optical axis
- C** Indicator diodes
- D** Receiver
- E** Transmitter

Electrical connection

Connector, 4-pin

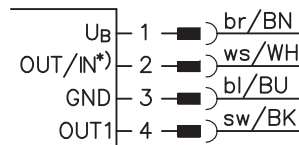

Cable, 4 wires

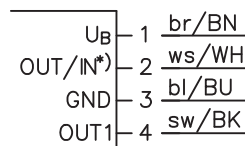

Selection pin 2

*)	OUT	IN
	OUT 2	active
	not connected (n.c.)	

We reserve the right to make changes •DS_HRTR25B_Standard_en_50114840.fm

Specifications

Optical data

Typ. scanning range limit ¹⁾	0 ... 1000mm
Scanning range ²⁾	see tables
Adjustment range ¹⁾	50 ... 1000mm
Black/white error < 10%	up to 350mm
Light beam characteristic	divergent, square
Light beam dimensions	approx. 8mm x 8mm at a distance of 50mm, approx. 19mm x 19mm at a distance of 200mm, approx. 29mm x 29mm at a distance of 600mm
Light source ³⁾	LED (modulated light)
Wavelength	620nm (visible red light)

Timing

Switching frequency	250Hz
Response time	2ms
Delay before start-up	≤ 300ms (acc. to. IEC 60947-5-2)

Electrical data

Operating voltage U_B ⁴⁾	10 ... 30VDC (incl. residual ripple)
Residual ripple	≤ 15% of U_B
Open-circuit current	≤ 15mA
Switching output	.../66 ⁵⁾ 2 push-pull switching outputs pin 2: PNP dark switching, NPN light switching pin 4: PNP light switching, NPN dark switching
	.../6 ⁵⁾ 1 push-pull switching output pin 4: PNP light switching, NPN dark switching
	.../44 2 PNP switching outputs, complementary
	.../4 1 PNP switching output light switching, pin 2: not connected ⁶⁾
	.../4D 1 PNP switching output dark switching, pin 2: not connected ⁶⁾
	.../2 1 NPN switching output light switching, pin 2: not connected ⁶⁾
Function characteristics	light/dark switching
Signal voltage high/low	≥ ($U_B - 2V$) / ≤ 2V
Output current	max. 100mA
Scanning range	adjustable via 10-turn potentiometer

Indicators

Green LED	ready
Yellow LED	object detected - reflection

Mechanical data

Housing	plastic (PC-ABS)
Optics cover	plastic (PMMA)
Weight	with connector: 15g with 200mm cable and connector: 30g with 2m cable: 55g
Connection type	cable 2m (cross section 4x0.20mm ²), connector M8 or M12, cable 0.2m with connector M8 or M12

Environmental data

Ambient temp. (operation/storage) ⁷⁾	-40°C ... +60°C / -40°C ... +60°C
Protective circuit ⁸⁾	2, 3
VDE safety class ⁹⁾	II
Protection class	IP 66, IP 67
Light source	free group (in accordance with EN 62471)
Standards applied	IEC 60947-5-2
Certifications	UL 508, C22.2 No.14-13 ⁴⁾ ⁷⁾ ¹⁰⁾

Options

Activation input active	
Transmitter active/not active	≥ 8V / ≤ 2V
Activation/disable delay	≤ 1ms
Input resistance	10KΩ ± 10%

- 1) Typ. scan. range limit/adjustment range: max. achievable scanning range/adjustment range for light objects (white 90%)
- 2) Scanning range: recommended scanning range for objects with different diffuse reflection
- 3) Average life expectancy 100,000h at an ambient temperature of 25°C
- 4) For UL applications: for use in class 2 circuits according to NEC only
- 5) The push-pull switching outputs must not be connected in parallel
- 6) Pin 2: unassigned, hence especially suitable for the connection to AS-interface I/O coupling modules
- 7) UL certified in the temperature range -30°C to 60°C
- 8) 2=polarity reversal protection, 3=short-circuit protection for all transistor outputs
- 9) Rating voltage: 50V
- 10) These proximity switches shall be used with UL Listed Cable assemblies rated 30V, 0.5A min, in the field installation, or equivalent (categories: CYJV/CYJV7 or PVVA/PVVA7)

Tables

1	0	1000
2	5	700
3	5	600

1	white 90%
2	grey 18%
3	black 6%

Scanning range [mm]

Diagrams

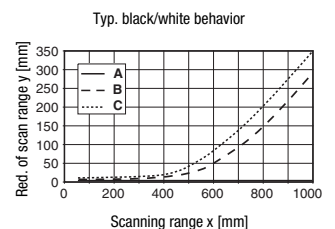
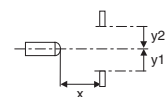
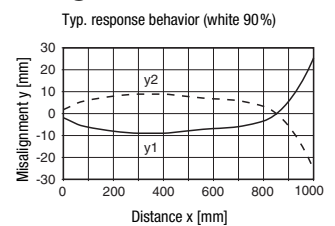

Remarks

Operate in accordance with intended use!

- ⚠ This product is not a safety sensor and is not intended as personnel protection.
- ⚠ The product may only be put into operation by competent persons.
- ⚠ Only use the product in accordance with the intended use.

UL REQUIREMENTS

Enclosure Type Rating: Type 1

For Use in NFPA 79 Applications only.

Adapters providing field wiring means are available from the manufacturer. Refer to manufacturers information.

CAUTION – the use of controls or adjustments or performance of procedures other than those specified herein may result in hazardous radiation exposure.

ATTENTION ! Si d'autres dispositifs d'alignement que ceux préconisés ici sont utilisés ou s'il est procédé autrement qu'indiqué, cela peut entraîner une exposition à des rayonnements et un danger pour les personnes.

HRTR 25B

Diffuse reflection light scanner with background suppression

Part number code

H R T R 2 5 B / 6 6 . 8 - X L , 2 0 0 - S 1 2

Operating principle

HRT Diffuse reflection light scanners with background suppression

Operating principle

N/A Infrared light
R Red light

Construction/version

25B 25B Series

Switching output/function (OUT 1: pin 4, OUT 2: pin 2)

/66 2 x push-pull transistor output, OUT 1: light switching, OUT 2: dark switching
/6 1 x push-pull transistor output, OUT 1: light switching, OUT 2: not connected (n. c.)
/44 2 x PNP transistor output, OUT 1: light switching, OUT 2: dark switching
/4 1 x PNP transistor output, OUT 1: light switching, OUT 2: not connected (n. c.)
/4D 1 x PNP transistor output, OUT 1: dark switching, OUT 2: not connected (n. c.)
/2 1 x NPN transistor output, OUT 1: light switching, OUT 2: not connected (n. c.)

Equipment

.8 Activation input

Light spot

N/A Standard light spot
-S Small light spot
-XL Elongated light spot

Electrical connection

N/A Cable, PVC, standard length 2000mm, 4-wire
-S8 M8 connector, 4 pin (plug)
-S12 M12 connector, 4 pin (plug)
,200-S8 Cable, PVC, length 200mm with M 8 connector, 4 pin, axial (plug)
,200-S8.1 Cable, PVC, 200 mm length with M 8 connector, 4-pin, axial (plug),
 NM construction with snap locking in accordance with IEC 61076-2-101
,200-S12 Cable, PVC, length 200mm with M 12 connector, 4 pin, axial (plug)

Order guide

The sensors listed here are preferred types; current information at www.leuze.com

Order code

Part No.

HRTR 25B/66-S12	50114491
HRTR 25B/4D,200-S8.1	50115135
HRTR 25B/4D,200-S8	50115136
HRTR 25B/4D,200-S12	50115137
HRTR 25B/4D-S12	50115138
HRTR 25B/6	50115140
HRTR 25B/6.8-S12	50115141
HRTR 25B/6-S12	50115144
HRTR 25B/44-S8	50115146
HRTR 25B/44-S12	50115147
HRTR 25B/66	50115150
HRTR 25B/66,200-S8	50115151
HRTR 25B/66,200-S12	50115152
HRTR 25B/66-S8	50115153

Application notes



- For glossy surfaces (e.g. metals), the light beam should not be incident on the object surface at a right angle. A slight inclination is sufficient for preventing undesired direct reflections. This may result in a reduction in the scanning range.
- Objects should only be moved in laterally from the right or left. Moving in objects from the connector side or operating side is to be avoided.
- Outside of the scanning range, the sensor operates as an energetic diffuse reflection light scanner. Light objects can still be reliably detected up to the scanning range limit.
- The sensors are equipped with effective measures for the maximum avoidance of mutual interference should they be mounted opposite one another. Opposite mounting of multiple sensors of the same type should, however, absolutely be avoided.