

HTU418B...W

Ultrasonic sensors, angled 90° with 2 switching outputs

en 02-2016/05 50129816-01



Dimensioned drawing

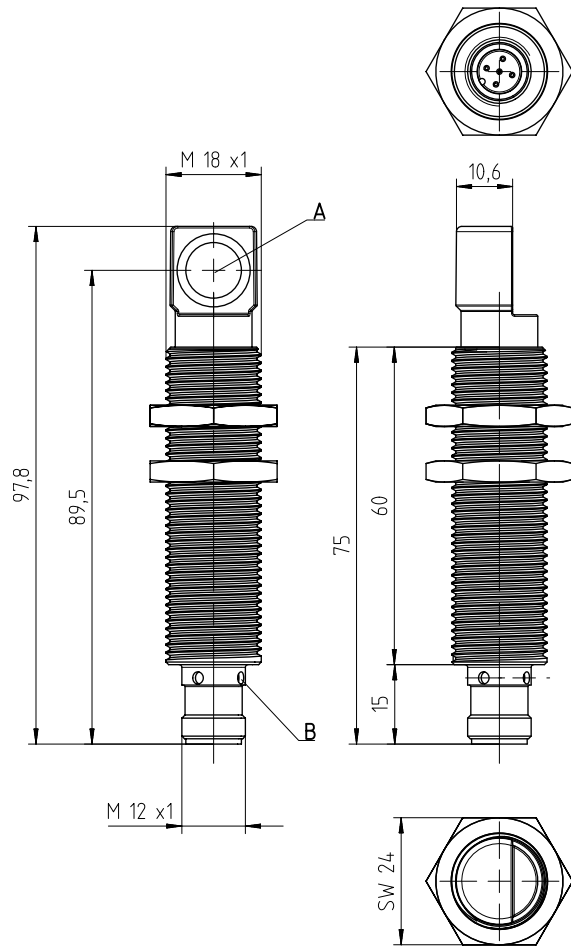

- A** Active sensor surface
- B** Indicator diodes



25 ... 400 mm
150 ... 1300 mm



- Function largely independent of surface properties, ideal for detection of liquids, bulk materials, transparent media, ...
- Sound exit less than 90° to the longitudinal axis
- Small dead zone at long scanning range
- Adjustment of the switching point can be taught for each switching output
- NO/NC function reversible
- 2 switching outputs (PNP)

Electrical connection

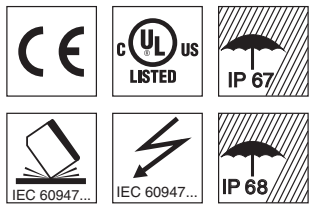
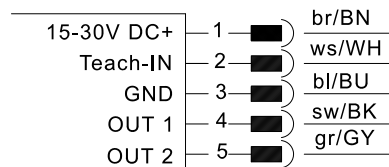

Accessories:

(available separately)

- Mounting systems
- Mounting adapter M18-M30: BTX-D18M-D30 (Part no. 50125860)
- Cables with M12 connector (K-D ...)
- Teach adapter PA1/XTSX-M12 (Part no. 50124709)

We reserve the right to make changes • DS_HTU418BW4T4_en_50129816_01.fm

Specifications

Ultrasonic specifications

Scanning range ¹⁾
 Adjustment range
 Ultrasonic frequency
 Typ. opening angle
 Resolution
 Direction of beam
 Reproducibility
 Switching hysteresis
 Temperature drift

HTU418B-400.W/4T4...

25 ... 400mm ²⁾
 25 ... 400mm
 310kHz
 9°
 1mm
 axial
 ± 0.15% of end value ¹⁾
 5mm ¹⁾
 0.17%/K

HTU418B-1300.W/4T4...

150 ... 1300mm ³⁾
 150 ... 1300mm
 200kHz
 16°
 1mm
 axial
 ± 0.15% of end value ¹⁾
 10mm ¹⁾
 0.17%/K

Timing

Switching frequency
 Response time
 Delay before start-up

7Hz
 71ms
 < 300ms

8Hz
 62ms
 < 300ms

Electrical data

Operating voltage U_B ⁴⁾
 Residual ripple
 Open-circuit current
 Switching output
 Function
 Output current
 Switching range adjustment

15 ... 30V DC (incl. ± 10% residual ripple)
 ± 10% of U_B
 ≤ 50mA
 2x PNP transistor
 2 x NO contact, reversible
 max. 150mA
 teach-in (pin 2):
 for OUT1: connect to GND for 2 ... 7s
 for OUT2: connect to GND for 7 ... 12s
 teach-in (pin 2):
 for OUT1: connect to U_B for 2 ... 7s
 for OUT2: connect to U_B for 7 ... 12s

Changeover NO/NC

Indicators

Yellow LED
 Yellow LED, flashing
 Green LED

OUT1: object detected
 teach-in / teaching error
 object within the scanning range

Mechanical data

Housing
 Weight
 Ultrasonic transducer
 Connection type
 Fitting position

all metal - brass, nickel-plated
 50g
 piezoceramic ⁵⁾
 M12 connector, 5-pin
 any

Environmental data

Ambient temp. (operation/storage)
 Protective circuit ⁶⁾
 VDE safety class
 Degree of protection
 Standards applied
 Certifications

-25°C ... +70°C/-30°C ... +85°C
 1, 2, 3
 III
 IP 67 and IP 68
 EN 60947-5-2
 UL 508, C22.2 No.14-13 ⁴⁾ ⁷⁾ ⁸⁾

- 1) At 20°C
- 2) Target: 20mm x 20mm plate
- 3) Target: 100mm x 100mm plate
- 4) For UL applications: for use in class 2 circuits according to NEC only
- 5) The ceramic material of the ultrasonic transducer contains lead zirconium titanate (PZT)
- 6) 1=short-circuit and overload protection, 2=polarity reversal protection, 3=wire break and inductive protection
- 7) These proximity switches shall be used with UL Listed Cable assemblies rated 30V, 0.5A min, in the field installation, or equivalent (categories: CYJV/CYJV7 or PVVA/PVVA7)
- 8) Ambient temperature 85°C. Use same voltage supply for all circuits.

Remarks

Operate in accordance with intended use!

- ☞ This product is not a safety sensor and is not intended as personnel protection.
- ☞ The product may only be put into operation by competent persons.
- ☞ Only use the product in accordance with the intended use.

Diagrams

HTU418B-400.W/...-M12

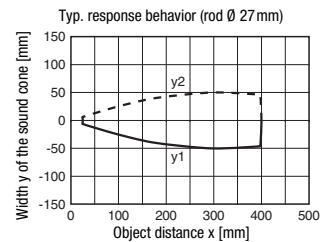
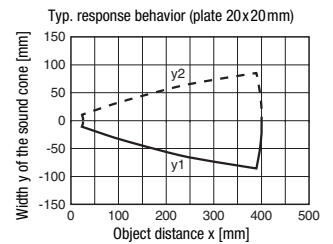

HTU418B-1300.W/...-M12

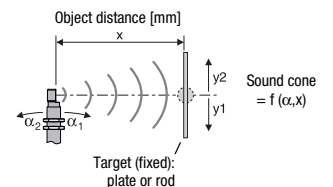
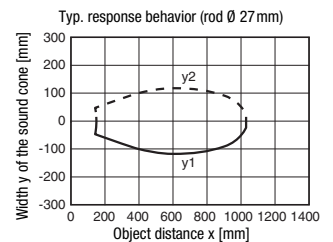
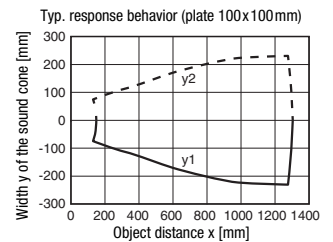
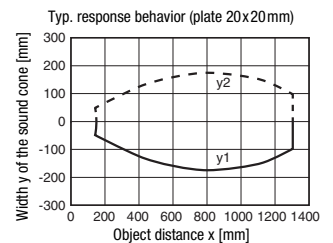

HTU418B...W

Ultrasonic sensors, angled 90° with 2 switching outputs

Part number code

H	T	U	4	1	8	B	-	1	3	0	0	.	W	/	4	T	4	-	M	1	2
---	---	---	---	---	---	---	---	---	---	---	---	---	---	---	---	---	---	---	---	---	---

Operating principle

HTU Ultrasonic sensor, scanning principle, with background suppression

Series

418B 418B Series, cylindrical M18 construction

Scanning range in mm

400 25 ... 400

1300 150 ... 1300

Equipment (optional)

W Design with angle head of 90°

Pin assignment of connector pin 4 / black cable wire (OUT1)

4 PNP output, NO contact preset

P PNP output, NC contact preset

2 NPN output, NO contact preset

N NPN output, NC contact preset

Pin assignment of connector pin 2 / white cable wire (Teach-IN)

T Teach input

Pin assignment of connector pin 5 / gray cable wire (OUT2)

4 PNP output, NO contact preset

P PNP output, NC contact preset

2 NPN output, NO contact preset

N NPN output, NC contact preset

Connection technology

M12 M12 connector, 5-pin

Order guide

The sensors listed here are preferred types; current information at www.leuze.com.

	Designation	Part no.
Scanning range		
25 ... 400mm	HTU418B-400.W/4T4-M12	50129826
150 ... 1300mm	HTU418B-1300.W/4T4-M12	50129827

Device functions and indicators

All settings on the sensor are taught-in via the **Teach-IN** input. Device status and switching states are indicated as follows by means of a yellow and green LED:

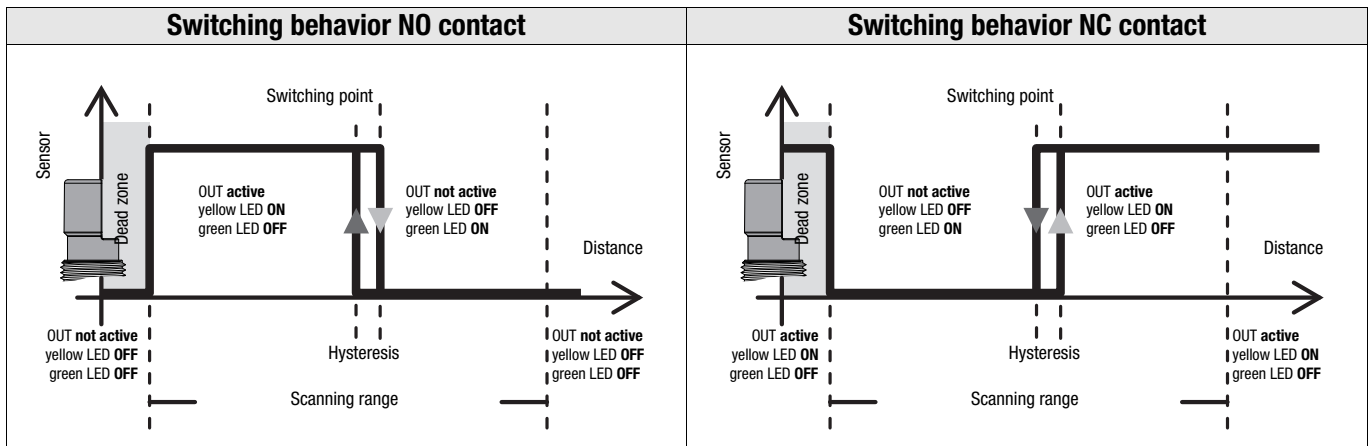

Notice!

In measurement operation, the yellow and green LED only indicate the behavior of output **OUT1**. The behavior of output **OUT2** is not indicated.

Adjusting the switching points via the teach input

The switching points of the sensor outputs **OUT1/OUT2** are set to 400mm or 1000mm on delivery.

By means of a simple teach event, the two switching points can be individually taught to an arbitrary distance within the scanning range. The Leuze **PA1/XTSX-M12** teach adapter can be used for this purpose. The adapter can also be used to easily switch the output function from NO contact to NC contact.

1-point teach of output OUT1	1-point teach of output OUT2
1. Place object at desired switching distance. 2. For the adjustment of OUT1, connect input Teach-IN to GND for 2 ... 7s (Leuze teach adapter: position "Teach-GND"). The current state of output OUT1 is frozen during the teach event. 3. The yellow LED flashes at 3Hz and is then ON. The current object distance has been taught as the new switching point. 4. Error-free teach: switching behavior according to the diagram shown above. Faulty teach (object may be too close or too far away – please note scanning range): yellow LED flashes at 5Hz until an error-free teach event is performed. Output OUT1 is inactive as long as there is a teach error.	1. Place object at desired switching distance. 2. For the adjustment of output OUT2, connect input Teach-IN to GND for 7 ... 12s (Leuze teach adapter: position "Teach-GND"). The current state of output OUT2 is frozen during the teach event. 3. The yellow LED flashes at 3Hz. The current object distance has been taught as the new switching point. 4. Error-free teach: switching behavior according to the diagram shown above. Faulty teach (object may be too close or too far away – please note scanning range): yellow LED flashes at 5Hz until an error-free teach event is performed. Output OUT2 is inactive as long as there is a teach error.

Adjusting the switching function (NC/NO) via the teach input

The switching function of both sensor outputs is set to normally open (NO) on delivery.

If the switching function is changed, the switching output is changed to the opposite state (toggled).

Changeover of the switching function of output OUT1	Changeover of the switching function of output OUT2
1. To change the switching function, connect input Teach-IN to U_B for 2 ... 7s (Leuze teach adapter: position "Teach- U_B "). The current state of output OUT1 is frozen while the adjustment is made. 2. The green and yellow LEDs flash alternately at 2Hz. The switching function was changed over. The switching behavior corresponds to the diagram shown above.	1. To change the switching function, connect input Teach-IN to U_B for 7 ... 12s (Leuze teach adapter: position "Teach- U_B "). The current state of output OUT2 is frozen while the adjustment is made. 2. The green and yellow LEDs flash alternately at 5Hz. The switching function was changed over. The switching behavior corresponds to the diagram shown above.



Notice!

Please note that **the switching point is taught when GND is connected and the output function is reversed when U_B is connected. If no sensor action is desired, pin 2 must remain unconnected!**