

**KRTL 3B**

**Laser contrast scanner**

en 05-2014/05 50110624-02



**Dimensioned drawing**

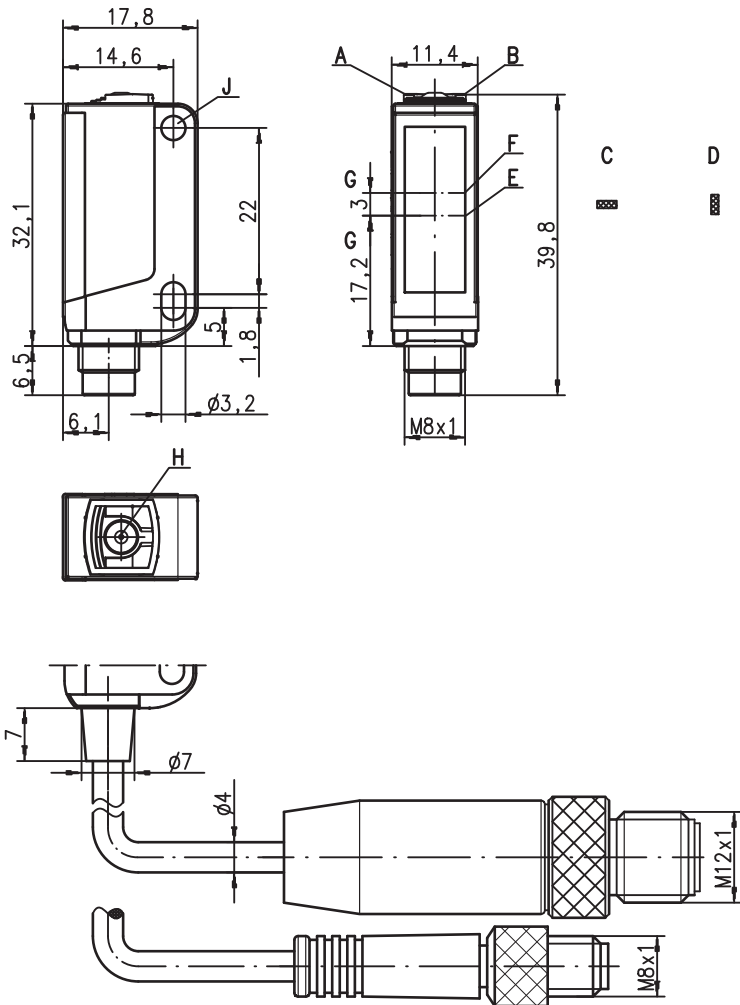

- A Green indicator diode
- B Yellow indicator diode
- C Light spot orientation horizontal
- D Light spot orientation vertical
- E Transmitter
- F Receiver
- G Optical axis
- H Teach button
- J Attachment sleeve

**Electrical connection**

Plug connection, 4-pin

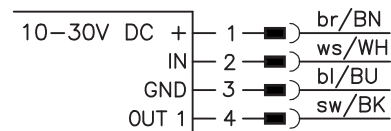

**CDRH 60mm**

**IO-Link**

- Red light laser transmitter
- Various teach variants
- Small light spot
- Switching threshold adjustment via EasyTune
- Level adaptation for glossy objects
- Keyboard lockout
- Remote teach via cable
- Pulse stretching 20ms

**Accessories:**

(available separately)

- Mounting systems (BT 3...)
- Cable with M8 or M12 connector (K-D ...)

We reserve the right to make changes • DS\_KRTL3B\_en\_50110624\_02.fm

## Specifications

### Optical data

Scanning range <sup>1)</sup>	60mm ± 20mm
Light spot dimensions	0.5mm x 1.0mm (at a distance of 60mm)
Light spot orientation	vertical (see dimensioned drawing)
Light source <sup>2)</sup>	laser-generated red light (laser class 1)
Wavelength	655nm
Max. output power	1mW
Pulse duration	4µs

### Sensor operating modes

IO-Link	COM2 (38.4kBaud)
SIO	standard push-pull
Dual Core	no

### Timing of the sensor

Internal switching frequency	4kHz
Internal response time	125µs
Response jitter, internal	35µs
Repeatability <sup>3)</sup>	0.05mm
Delay before start-up	≤ 300ms
Teach process	static 1-point, static 2-point or dynamic 2-point
Teach delay	≤ 10ms

### Timing of the outputs

Response time	Pin 4	IO-Link COM2: acc. to IO-Link specification (typically 2.5ms)
		SIO: 50µs

### Electrical data

Operating voltage $U_B$ <sup>4)</sup>	with SIO	10 ... 30VDC (incl. residual ripple)
	with COM2	18 ... 30VDC (incl. residual ripple)
Residual ripple		≤ 15% of $U_B$
Output/function	.../2...	pin 4: GND if mark detected
	.../4...	pin 4: $U_B$ if mark detected
	.../6...	pin 4: IO-Link SIO mode, $U_B$ if mark detected
	.../6...	pin 4: IO-Link COM2 mode, see configuration file IODD
Signal voltage high/low		≥ ( $U_B - 2V$ ) / ≤ 2V
Output current		max. 100mA
Open-circuit current		≤ 20mA

### Indicators

Green LED in continuous light	ready
Green and yellow LED flashing at 3Hz	teach event active
Green and yellow LED flashing at 8Hz	teaching error
Green LED off and yellow LED flashing at 8Hz	device error
Yellow LED in continuous light	mark detected (dependent on the teach sequence)
Yellow LED flashing at 8Hz	laser error, replace device
Transmitter LED flashing at 8Hz	teaching error

### Mechanical data

Housing	plastic (PC-ABS), with attachment sleeve, nickel-plated steel
Optics cover	plastic (PMMA)
Weight	10g
Connection type	M8 connector, metal

### Environmental data

Ambient temp. (operation/storage)	-10°C ... +55°C / -30°C ... +70°C
Protective circuit <sup>5)</sup>	2, 3
VDE safety class	III
Protection class	IP 67
Laser class	1 (in accordance with EN 60825-1)
Standards applied	IEC 60947-5-2
Certifications	UL 508, C22.2 No.14-13 <sup>4)</sup> <sup>6)</sup>

### Options

#### Input pin 2

Function characteristics	keyboard lockout / line teach / pulse stretching
Input active/not active	≥ 8V / ≤ 2V or not connected

#### Output pin 4

Line teach active	for SIO	2Hz at the switching output
	for COM2	see configuration file IODD
Error after line teach	for SIO	2Hz at the switching output
	for COM2	see configuration file IODD

- 1) Scanning range: recommended range with performance reserve
- 2) Average life expectancy 50,000h at an ambient temperature of 25°C
- 3) At conveyor speed 1m/s
- 4) For UL applications: for use in class 2 circuits according to NEC only
- 5) 2=polarity reversal protection, 3=short-circuit protection for all transistor outputs
- 6) These proximity switches shall be used with UL Listed Cable assemblies rated 30V, 0.5A min, in the field installation, or equivalent (categories: CYJV/CYJV7 or PVVA/PVVA7)

## Tables

## Diagrams

## Remarks

### Operate in accordance with intended use!

- ↪ This product is not a safety sensor and is not intended as personnel protection.
- ↪ The product may only be put into operation by competent persons.
- ↪ Only use the product in accordance with the intended use.

- With glossy objects, the sensor is to be fastened at an inclination of approx. 10° relative to the object surface.

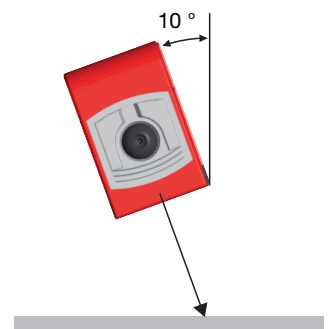

**Order guide**

Selection table		Order code →				
Equipment ↓		KRTL 3B/6.3111-S8 Part no. 501 11321	KRTL 3B/4.3111-S8 Part no. 501 10592	KRTL 3B/2.3111-S8 Part no. 50110593	KRTL 3B/4.3111,200-S12 Part no. 50110594	KRTL 3B/2.3111,200-S12 Part no. 50110595
Transmitter color	white light					
	RGB (red, green, blue)					
	laser-generated red light (laser class 1)	●	●	●	●	●
Light spot orientation	vertical	●	●	●	●	●
	horizontal					
	round					
Output (OUT 1)	PNP transistor output		●		●	
	NPN transistor output			●		●
	push-pull switching output	●				
	IO-Link COM2	●				
Input (IN)	teach input	●	●	●	●	●
Housing	standard	●	●	●	●	●
	economy					
Connection	M8 connector, metal	4-pin	●	●	●	
	M8 connector, plastic	4-pin				
	200mm cable with M12 connector	4-pin				●
Teach-in method	static 1-point					
	static 2-point	●	●	●	●	●
	dynamic 2-point					
Response time / Switching frequency	50µs / 10kHz					
	83µs / 6kHz					
	125µs / 4kHz	●	●	●	●	●
Configuration	switching threshold adjustment with EasyTune via teach button	●	●	●	●	●
	remote teach, keyboard lockout and pulse stretching via pin 2	●	●	●	●	●
	teach level 1, teach-level 2 and pulse stretching via teach button	●	●	●	●	●

**Laser safety notices – Laser class 1**

**ATTENTION, LASER RADIATION – LASER CLASS 1**

The device fulfills the EN 60825-1:2008-05 (IEC 60825-1:2007) safety regulations for a product in **laser class 1** as well as the U.S. 21 CFR 1040.10 regulations with deviations corresponding to "Laser Notice No. 50" from June 24th, 2007.

- ↳ Adhere to the applicable legal and local regulations regarding protection from laser beams acc. to EN 60825 (IEC 60825) in its latest version.
- ↳ The device must not be tampered with and must not be changed in any way.  
There are no user-serviceable parts inside the device.  
Repairs must only be performed by Leuze electronic GmbH + Co. KG.

## IO-Link process data

The sensor transmits 2 bytes to the master.

Data bit																Assignment	Default settings
15	14	13	12	11	10	9	8	7	6	5	4	3	2	1	0		
																Switching output	0 = no mark, 1 = mark detected
																Not used	Free
																Sensor operation	0 = off, 1 = on
																Switching threshold LSB	Value range 0 ... 31 (0 ... 100% in approx. 3% steps) 0% = min. switching threshold 100% = max. switching threshold
																Switching threshold	
																Switching threshold	
																Switching threshold	
																Switching threshold MSB	
																Active transmitter LSB	00 = red, 01 = green or white, 10 = blue, 11 = all colors on (teach-in active)
																Active transmitter MSB	
																Not used	Free
																Measurement value LSB	Value range 0 ... 31 (0 ... 100% in approx. 3% steps) 0% = min. signal level 100% = max. signal level
																Measurement value	
																Measurement value	
																Measurement value	
																Measurement value MSB	



Additional information on the IO-Link service data is available on request.

## Static 2-point teach

Suitable for manual positioning of the marks (availability dependent on device type).

### Switching threshold in center:

<p>Position the background.</p>	<p>Press teach button for 2 ... 7s and release.</p> <p>2 ... 7s</p> <p>Value for background is accepted.</p>	<p>LEDs flash simultaneously.</p> <p><b>Simultaneous flashing</b></p>	<p>Position the mark.</p>	<p>Briefly press teach button.</p> <p>Value for mark is accepted.</p>	<p>Device in RUN mode. Yellow LED illuminates.</p> <p>Switching threshold set in the center.</p>
---------------------------------	--	---	---------------------------	---	--

### Switching threshold near the mark:

<p>Position the background.</p>	<p>Press teach button for 7 ... 12s and release.</p> <p>7 ... 12s</p> <p>Value for background is accepted.</p>	<p>LEDs flash alternately.</p> <p><b>Alternating flashing</b></p>	<p>Position the mark.</p>	<p>Briefly press teach button.</p> <p>Value for mark is accepted.</p>	<p>Device in RUN mode. Yellow LED illuminates.</p> <p>Switching threshold is set near the mark.</p>
---------------------------------	--	---	---------------------------	---	---





**KRTL 3B**

**Laser contrast scanner**



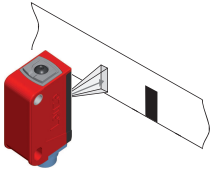

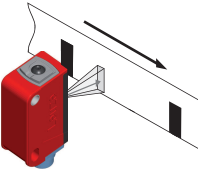
**Dynamic 2-point teach**

Suitable for marks moved during automated machine processes (availability dependent on device type).

**Switching threshold in center**

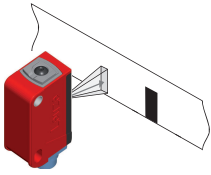
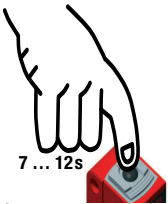
<p>Position the background.</p> 	<p>Press teach button for 2 ... 7s and release.</p>  <p>2 ... 7s</p> <p>Measurement window opens.</p>	<p>LEDs flash simultaneously.</p>  <p><b>Simultaneous flashing</b></p>	<p>Allow marks to pass through dynamically.</p> 	<p>Briefly press teach button.</p>  <p>Measurement window closes.</p>	<p>Device in RUN mode. Yellow LED is off.</p>  <p>Switching threshold set in the center.</p>
---	--	---	--	--	---

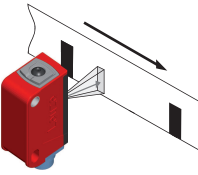



**Switching threshold near the mark**

<p>Position the background.</p> 	<p>Press teach button for 7 ... 12s and release.</p>  <p>7 ... 12s</p> <p>Measurement window opens.</p>	<p>LEDs flash alternatingly.</p>  <p><b>Alternating flashing</b></p>	<p>Allow marks to pass through dynamically.</p> 	<p>Briefly press teach button.</p>  <p>Measurement window closes.</p>	<p>Device in RUN mode. Yellow LED is off.</p>  <p>Switching threshold is set near the mark.</p>
---	--	---	--	--	--



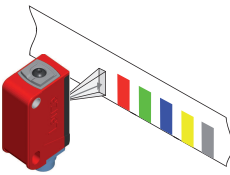
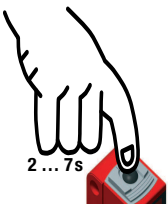

**Static 1-point teach**

Suitable for detecting all marks outside of the reference value (availability dependent on device type).

**Standard sensitivity**

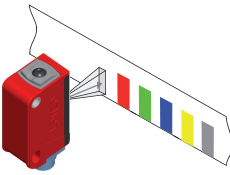
<p>Position the reference value.</p> 	<p>Press teach button for 2 ... 7s.</p>  <p>2 ... 7s</p>	<p>LEDs flash simultaneously.</p>  <p><b>Simultaneous flashing</b></p>	<p>Release teach button.</p>  <p>Value is accepted.</p>	<p>Device in RUN mode. Yellow LED is off.</p>  <p>Standard sensitivity is set.</p>
--	---	---	---	---

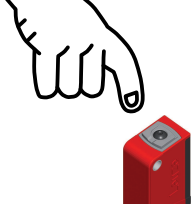
**High sensitivity**

<p>Position the reference value.</p> 	<p>Press teach button for 7 ... 12s.</p>  <p>7 ... 12s</p>	<p>LEDs flash alternatingly.</p>  <p><b>Alternating flashing</b></p>	<p>Release teach button.</p>  <p>Value is accepted.</p>	<p>Device in RUN mode. Yellow LED is off.</p>  <p>High sensitivity is set.</p>
--	---	---	---	---

## Switching threshold diagrams

### Static 2-point teach

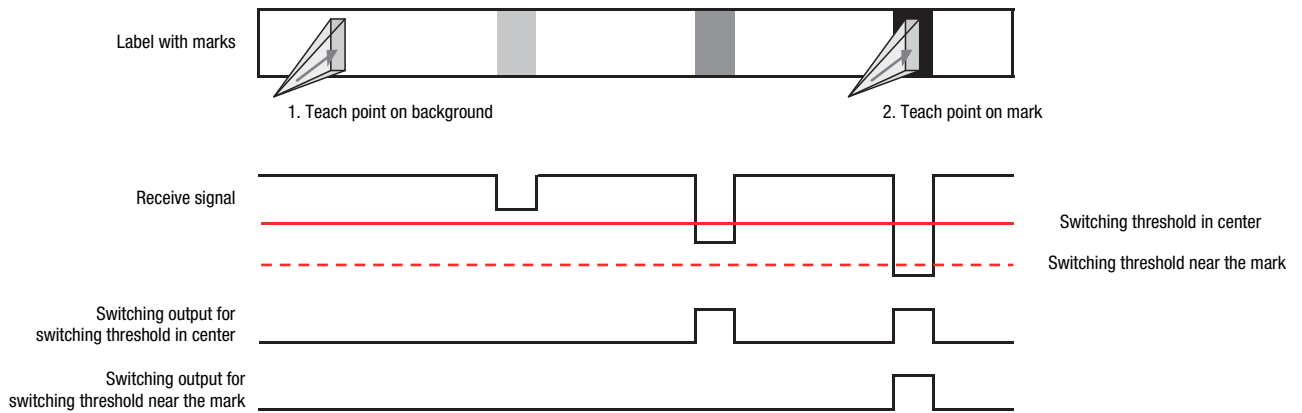

### Dynamic 2-point teach

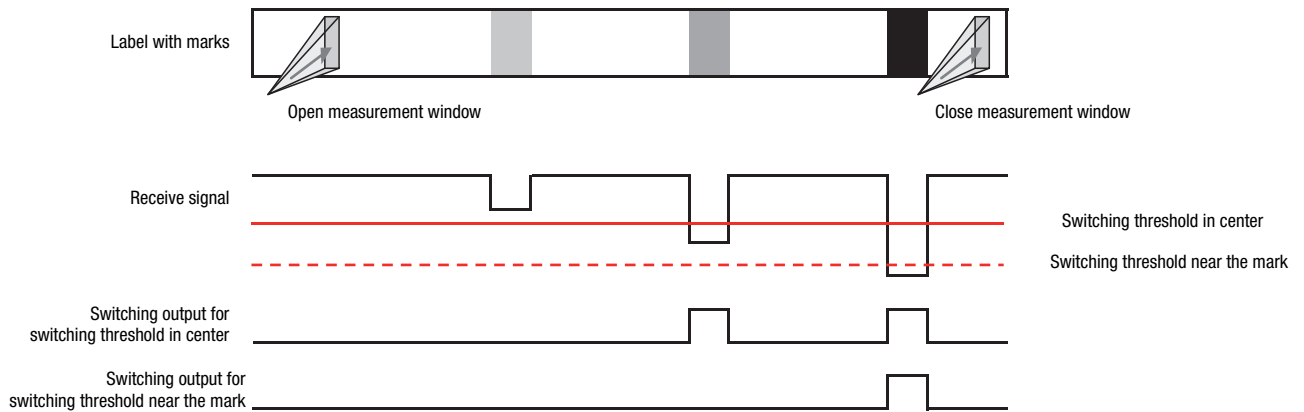

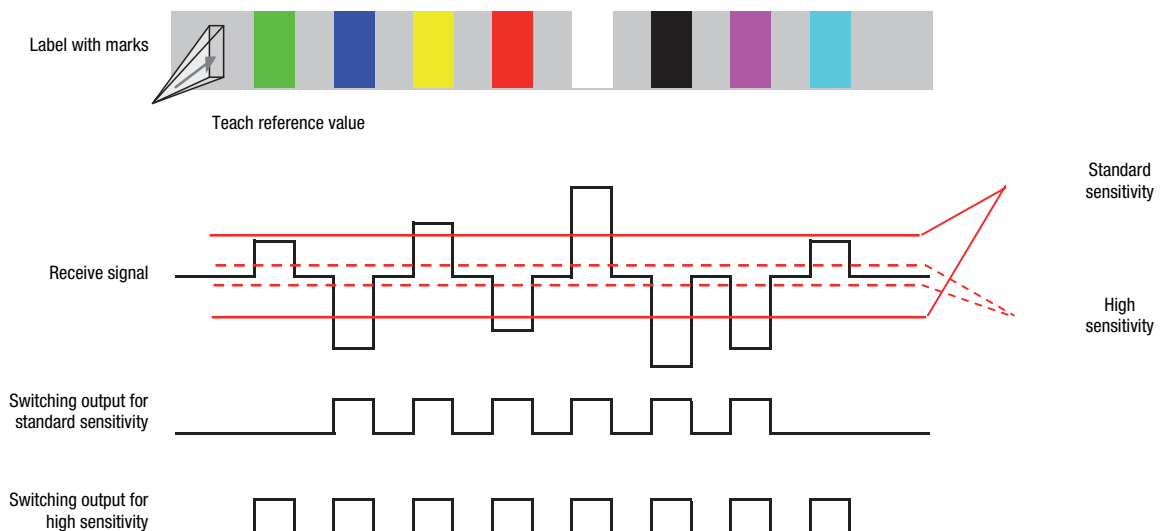

### Static 1-point teach



### Pulse stretching option

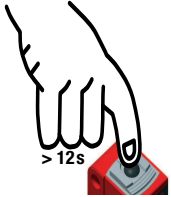

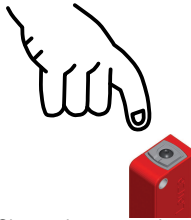
Switching pulse stretching on or off:

<p>Press the teach button longer than 12s.</p> 	<p>Only the green LED flashes.</p> <div style="display: flex; flex-direction: column; align-items: center;"> <div style="display: flex; align-items: center;">  <div style="margin-left: 10px;"> <p>The pulse stretching is switched off</p> </div> </div> <div style="display: flex; align-items: center; margin-top: 10px;">  <div style="margin-left: 10px;"> <p>The pulse stretching is switched on</p> </div> </div> </div> <p>After releasing the button, the yellow LED displays the state: yellow LED on: pulse stretching ON yellow LED off: pulse stretching OFF</p>	<p>Release teach button.</p>  <p>Change is accepted.</p>
--	--	---

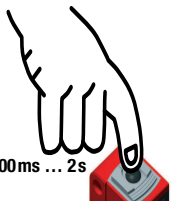

### "EasyTune" option - fine tuning of the switching threshold

Following power-on and completed teach event: Green LED illuminates continuously (ready)  
Yellow LED on/off continuously (mark detected/not detected)

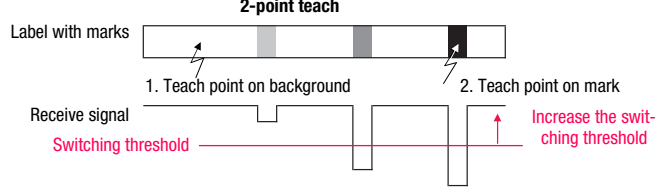
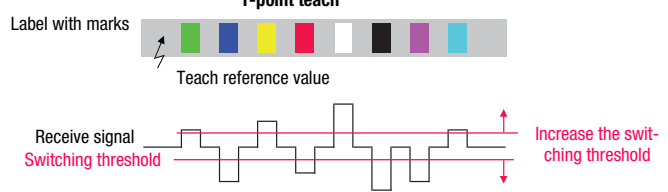
Increasing the switching threshold:

<p><b>Long press of the button = large force expenditure = increase switching threshold</b></p> <p>Each press of the button with a duration between 200ms and 2s increments the switching threshold.</p>  <p>200ms ... 2s</p>	 <p>Green LED flashes briefly once</p> <p>A press of the button is acknowledged by a single, brief flash of the green LED – the new switching threshold is now valid.</p>	<div style="text-align: center;"> <p><b>2-point teach</b></p>  </div> <div style="text-align: center;"> <p><b>1-point teach</b></p>  </div>
--	--	--

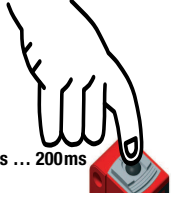
Reducing the switching threshold:

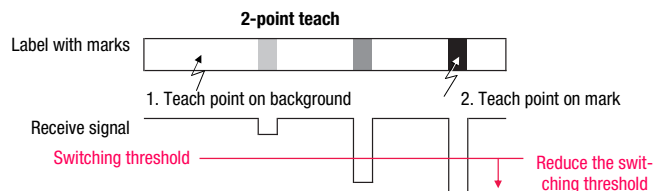
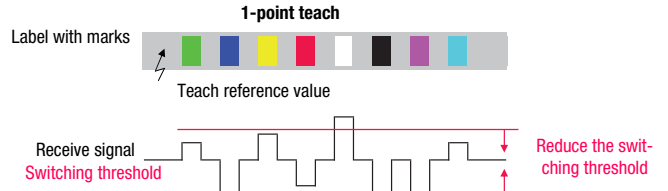
<p><b>Short press of the button = small force expenditure = reduce switching threshold</b></p> <p>Each press of the button with a duration between 2ms and 200ms decrements the switching threshold.</p>  <p>2ms ... 200ms</p>	 <p>Green LED flashes briefly once</p> <p>A press of the button is acknowledged by a single, brief flash of the green LED – the new switching threshold is now valid.</p>	<div style="text-align: center;"> <p><b>2-point teach</b></p>  </div> <div style="text-align: center;"> <p><b>1-point teach</b></p>  </div>
---	--	---



If the upper or lower end of the adjustment range is reached, the green and yellow LEDs flash at a considerably higher frequency of 8Hz for the duration of one second.

## Sensor adjustments via the input IN (Pin 2)



The following description applies to PNP switching logic!

Signal level **LOW**  $\leq 2V$

Signal level **HIGH**  $\geq (U_B - 2V)$

With the NPN models, the signal levels are inverted!

### Switching threshold in center / standard sensitivity

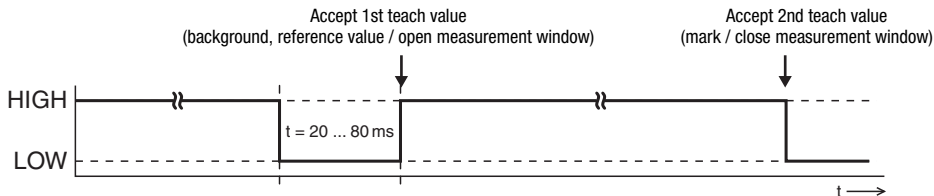

### Switching threshold near the mark / high sensitivity

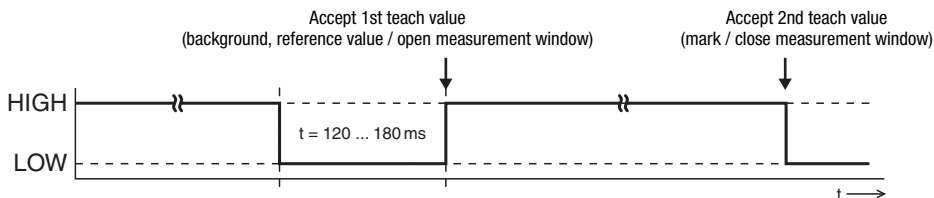

### Pulse stretching ON

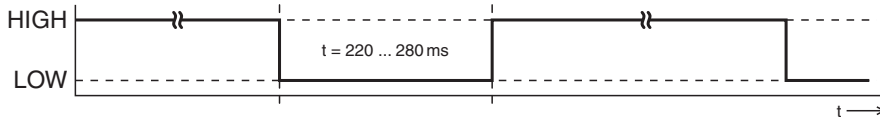

### Pulse stretching OFF

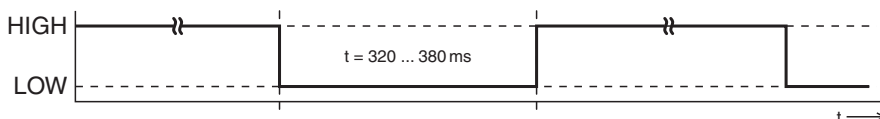

## Locking the teach button via the input IN (Pin 2)



A **static HIGH signal** ( $\geq 20ms$ ) at the teach input locks the teach button on the device if required, such that no manual operation is possible (e.g., protection from erroneous operation or manipulation).

If the teach input is not connected or if there is a static low signal, the button is unlocked and can be operated freely.

