

ODSL 9

Optical laser distance sensors

en 03-2012/11 50115257

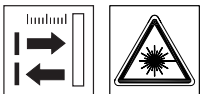

50 ... 450mm

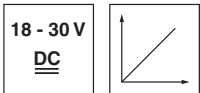

- Red light laser diode with laser class 1
- Large measurement range
- Reflection-independent distance information
- Measurement value is indicated in mm on LC display
- Configurable measurement mode
- Configurable measurement data preprocessing and filter
- Input (pin 2) for deactivating the laser, triggering, offset correction, reference measurement or teach-in
- M12 turning connector

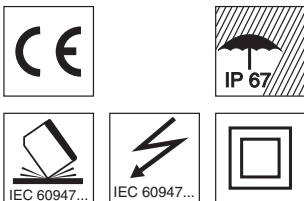

Accessories:

(available separately)

- Mounting systems
- Configuration software
- Cable with M12 connector (K-D ...)

Dimensioned drawing

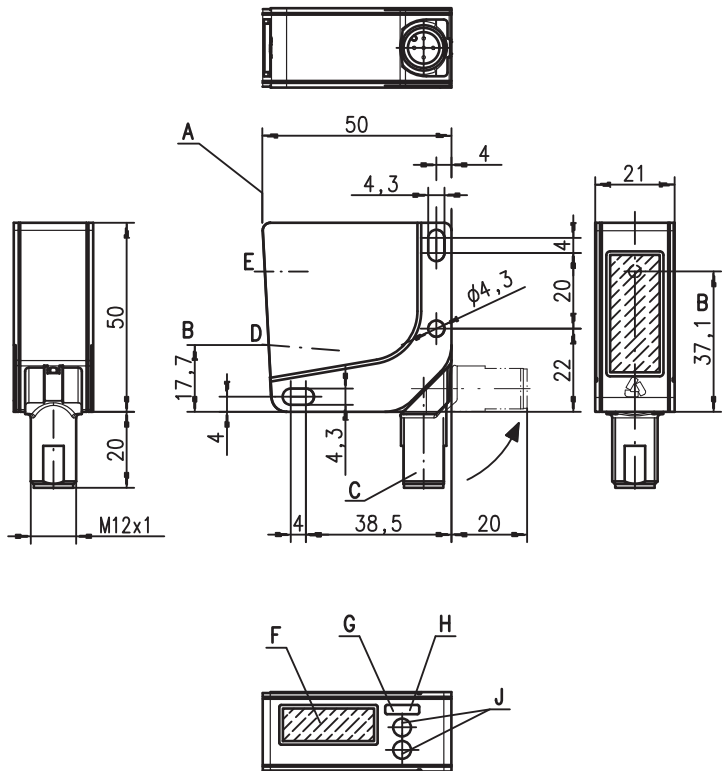

- A** Reference edge for the measurement
- B** Optical axis
- C** Device plug M12
- D** Receiver
- E** Transmitter
- F** LCD display
- G** Indicator diode yellow
- H** Indicator diode green
- J** Control buttons

Electrical connection

ODSL 9/C6.C1...

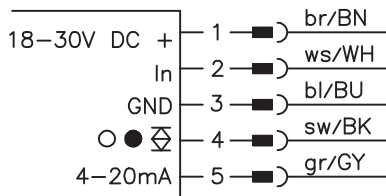

ODSL 9/V6.C1...

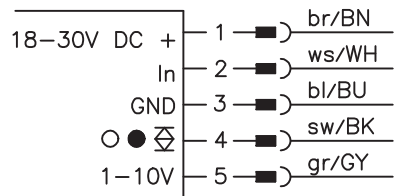

We reserve the right to make changes

Specifications

Optical data

Measurement range ¹⁾	50 ... 450mm
Resolution	0.1mm
Light source	laser
Wavelength	655nm
Light spot	divergent, 1x1mm ² at 450mm
Laser warning notice	see remarks

Error limits (relative to measurement distance)

Absolute measurement accuracy ¹⁾	± 1%
Repeatability ²⁾	± 0.5%
B/W detection thresh. (6 ... 90% rem.)	≤ 0.5%
Temperature compensation	yes ³⁾

Timing

Measurement time	4ms ¹⁾
Response time	≤ 12ms
Delay before start-up	≤ 300ms

Electrical data

Operating voltage U _B	...C6/V6	18 ... 30VDC (incl. residual ripple)
Residual ripple		≤ 15% of U _B
Open-circuit current		≤ 180mA
Switching output		push-pull switching output ⁴⁾ , PNP light switching, NPN dark switching
Signal voltage high/low		≥ (U _B -2 V)/≤ 2V
Analog output	...V6 ...C6	voltage 1 ... 10V / 0 ... 10V / 1 ... 5V / 0 ... 5V, R _L ≥ 2kΩ current 4 ... 20mA, R _L ≤ 500Ω

Indicators

Green LED	continuous light	ready	Teach-in on +U _B teaching procedure
	flashing	fault	
	off	no voltage	
Yellow LED	continuous light	object inside teach-in measurement distance	Teach-in on +U _B teaching procedure
	flashing	object outside teach-in measurement distance	
	off		

Mechanical data

Housing	plastic
Optics cover	glass
Weight	approx. 50g
Connection type	M12 connector, 5-pin

Environmental data

Ambient temp. (operation/storage)	-20°C ... +50°C / -30°C ... +70°C
Protective circuit ⁵⁾	1, 2, 3
VDE safety class ⁶⁾	II, all-insulated
Protection class	IP 67
Laser class	1 (acc. to EN 60825-1)
Standards applied	IEC 60947-5-2

- 1) Luminosity coefficient 6% ... 90%, complete measurement range, "Standard" operating mode, at 20°C, medium range of U_B, measurement object ≥ 50x50mm²
 2) Same object, identical environmental conditions, measurement object ≥ 50x50mm²
 3) Typ. ± 0.02 %/K
 4) The push-pull switching outputs must not be connected in parallel
 5) 1=transient protection, 2=polarity reversal protection, 3=short circuit protection for all outputs
 6) Rating voltage 50VAC

Order guide

Analog current output

1 teachable push/pull output

Analog voltage output

1 teachable push/pull output

Designation	Part No.
ODSL 9/C6.C1-450-S12	50115029
ODSL 9/V6.C1-450-S12	50115030

Tables

Diagrams

Remarks

- Measurement time depends on the reflectivity of the measurement object and on the measurement mode.
- **Approved purpose:**
This product may only be used by qualified personnel and must only be used for the approved purpose. This sensor is not a safety sensor and is not to be used for the protection of persons.

Analog output: characteristic curve for factory setting

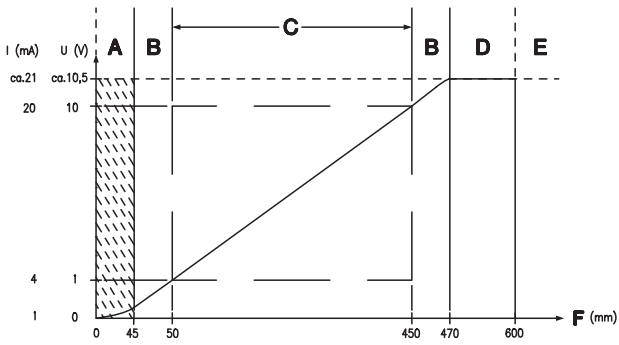

- A** Area not defined
- B** Linearity not defined
- C** Measurement range
- D** Object present
- E** No object detected
- F** Measurement distance

