

RK46C VarOS IO-Link

Retro-reflective photoelectric sensors

en 1-2016/05 50133485



0.4 ... 5.2m

- Sensor with homogeneous light-band (red light) for reliable detection of objects with different sizes and shapes
- Sensitivity adjustment from control via IO-Link interface
- Comprehensive diagnostic options via IO-Link interface
- Button locking
- Teachable, preset sensitivity levels for time-saving, optimum adaptation to object size, shape and form
- *Easy tune* – calibration of the sensor to e.g. transparent, perforated or small objects
- Precise alignment thanks to the special shape and form of the light-band
- Reliable detection even with depolarizing media (e.g. foil packaging)
- Light/dark switching via the teach button



Accessories:

(available separately)

- Mounting systems (BT 46, BTU 300M, BTU 900M)
- Ready-made cables (K-D ...)
- Reflectors
- IO-Link master set SET MD12-US2-IL1.1 + accessories - diagnostics set (part no. 50121098)

Dimensioned drawing

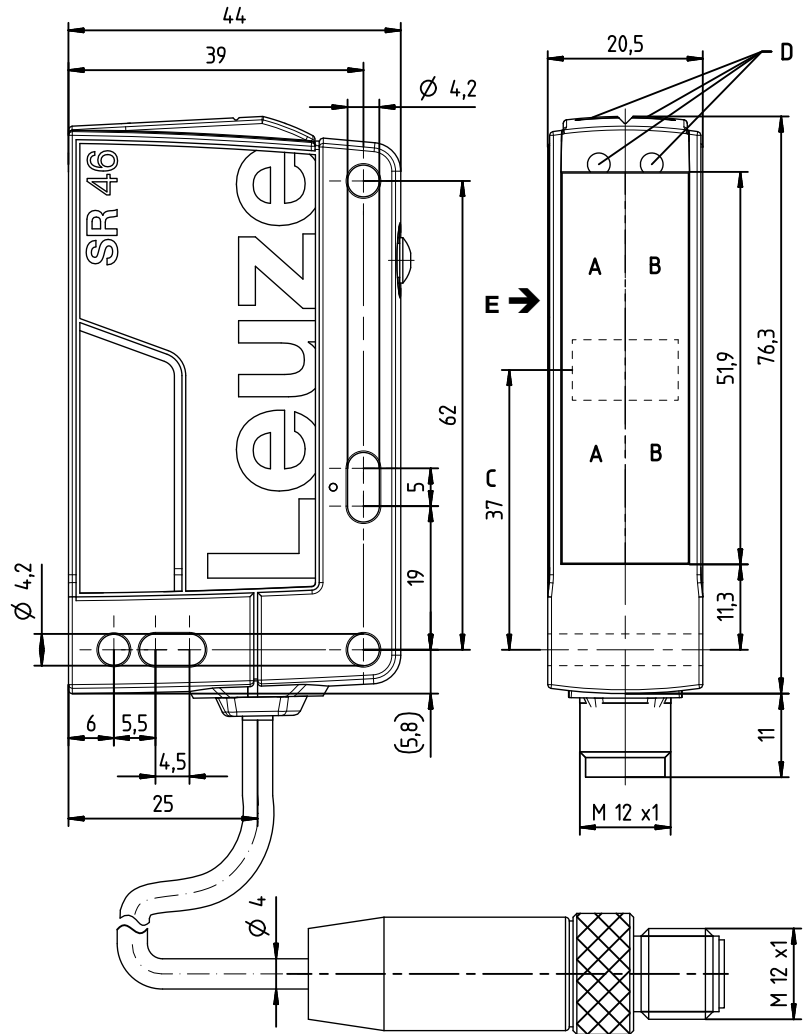

- A** Transmitter side
- B** Receiver side
- C** Center of light-band
- DA** Green indicator diode
- DB** Yellow indicator diode
- E** Preferred entry direction for precise positioning

Electrical connection

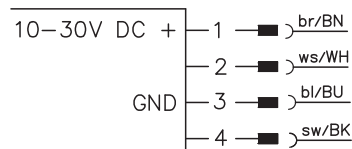

	Pin 1	Pin 2	Pin 3	Pin 4
RK46C.DXL3/LP-M12	+	PNP dark ¹⁾	GND	IO-Link / SIO

1) Factory setting; function configurable via IO-Link.

We reserve the right to make changes • DS_RK46CDXL3_IO_Link_en_50133485.fm

Technical data

Optical data

Typ. op. range limit (TK(S) 100x100) ¹⁾	0.4 ... 5.2m
Operating ranges ²⁾	see tables
Light source ³⁾	LED (modulated light)
Wavelength	620nm (visible red light)
Detection range	light-band approx. 50mm (see diagrams)
Resolution	typ. 12mm (max. approx. 8mm) ⁴⁾

Sensor operating modes

IO-Link	COM2 (38.1 kBaud, Frame 2.5, Vers. 1.1, min. cycle time 2.3 ms)
SIO	is supported
Configuration	direct configuration / system commands; attention: data storage is not supported!

Timing

Switching frequency	250 Hz
Response time	2ms
Readiness delay	< 300ms

Electrical data

Operating voltage U_B ⁵⁾	10 ... 30VDC (incl. residual ripple)
Residual ripple	$\leq 15\%$ of U_B
Open-circuit current	$\leq 20mA$
Switching outputs/functions	/LP pin 2: 1 PNP switching output, dark switching pin 4: IO-Link data, in SIO PNP switching output mode $\geq (U_B - 2V) \leq 2V$ max. 100mA adjustable via teach button (see IO-Link service data)
Signal voltage high/low	
Output current	
Sensitivity	

Indicators

Green LED	ready
Yellow LED	light path free
Flashing green/yellow LEDs	feedback during teach procedure

Mechanical data

Housing	plastic (PC-PBT)
Connector	plastic (PBT)
Optics	plastic (PMMA)
Operation	teach button
Weight	with M12 connector: approx. 60g
Connection type	M12 connector, 4-pin

Environmental data

Ambient temp. (operation/storage)	-40 °C ... +60 °C / -40 °C ... +70 °C
Protective circuit ⁶⁾	2, 3
VDE safety class ⁷⁾	III
Degree of protection	IP67, IP 69K
Light source	exempt group (in acc. with EN 62471)
Standards applied	IEC 60947-5-2
Chemical resistance	tested in accordance with ECOLAB
Certifications	UL 508, CSA C22.2 No.14-13 ⁸⁾

Additional functions

Via teach button:

Teach-in, *Easy Tune* (after activating via IO-Link).

Via IO-Link:

Teach-in, teach button lock, **autocontrol** warning message for signaling low function reserve (counting principle), light/dark switching, function of switching output Q2 (pin 2), configurable time functions.

- 1) Typ. operating range limit: max. attainable range without function reserve
- 2) Operating range: recommended range with function reserve
- 3) Average life expectancy 100,000h at an ambient temperature of 25°C
- 4) Depends on teach-in, see diagrams (sensitivity **increased** ≤ 12 mm)
- 5) For UL applications: for use in class 2 circuits only
- 6) 2=polarity reversal protection, 3=short circuit protection for all transistor outputs
- 7) Rating voltage 50V
- 8) These proximity switches shall be used with UL Listed Cable assemblies rated 30V, 0.5A min, in the field installation, or equivalent (categories: CYJV/CYJV7 or PVVA/PVVA7)

Notes

- Function reserve decreases as sensitivity increases.
- Max. resolution: approx. 8mm.
- Further applications:
 - Detection of transparent media
 - Detection of depolarizing media, e.g. foil packaging
 - Use as muting sensor
- Multiple sensors can be operated in a small area

Tables

Plastic reflectors:

Reflectors			Operating range
1	TK(S)	100x100	0.4 ... 4.0m
2	TK(S)	40x60	0.4 ... 3.0m

1	0.4	4.0	5.2
2	0.4	3.0	3.9

□ Operating range [m]
□ Typ. operating range limit [m]

TK ... = adhesive
TKS ... = screw type

Diagrams

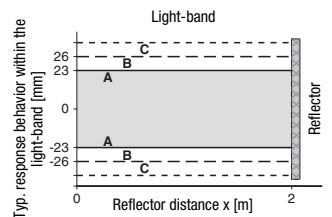

Reference object for detection: 19mm with reflector TKS 100x100

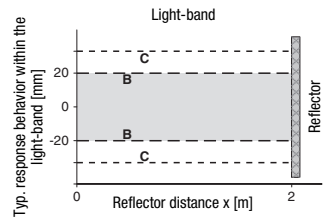

Reference object for detection: 12mm with reflector TKS 40x60

- A Standard** sensitivity
- B Increased** sensitivity
- C Further increased** sensitivity with *Easy tune* (range depends on taught value)

Notes

Observe intended use!

- ⚠ This product is not a safety sensor and is not intended as personnel protection.
- ⚠ The product may only be put into operation by competent persons.
- ⚠ Only use the product in accordance with its intended use.

RK46C VarOS IO-Link

Retro-reflective photoelectric sensors

Part number code

R K 4 6 C . D X L 3 / L P - M 1 2

Operating principle

RK Retro-reflective photoelectric sensor

Series

46C 46C series

Equipment

D Depolarizing media

Optical characteristic

XL Large light spot

Setting

3 Teach button

Pin assignment of connector pin 4 / black cable wire

2 NPN, light switching

N NPN, dark switching

4 PNP, light switching

P PNP, dark switching

L IO-Link

Pin assignment of connector pin 2 / white cable wire

X Not used

2 NPN, light switching

N NPN, dark switching

4 PNP, light switching

P PNP, dark switching

Connection technology

M12 M12 connector, 4-pin

200-M12 Cable 200mm with M12 connector, 4-pin

free Cable 2000mm

Order guide

The sensors listed here are preferred types; current information at www.leuze.com.

With M12 connector, 4-pin

Pin 4: IO-Link data, in SIO PNP switching output, light switching mode
Pin 2: PNP switching output, dark switching

Designation

RK46C.DXL3/LP-M12

Part no.

50133413

Precise alignment of sensor

The special shape and form of the light-band allows precise alignment of the sensor with the object to be detected or with the reflector.

Advantages:

- Maximum utilization of the light-band
- Reliable detection even with shocks/vibrations

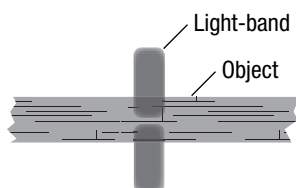

Align center of light-band with center of object/reflector!

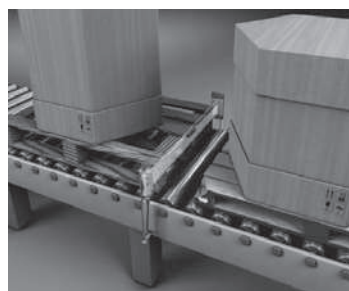

Reliable detection of different objects and objects with cutouts and openings, here pallets:

- different heights
- protruding boards
- damage

IO-Link process data

Output data device

Data bit								Assignment	Meaning
7	6	5	4	3	2	1	0		
								Switching output Q1	0 = inactive, 1 = active
								Warning output autoControl	0 = no warning, 1 = warning
								Sensor operation ¹⁾	0 = off, 1 = on
								Not used	free
								Not used	free
								Not used	free
								Not used	free
								Not used	free

1) Sensor operation off when detection is not possible (e.g during the teach event)

Input data device

Data bit								Assignment	Meaning
7	6	5	4	3	2	1	0		
								Deactivation	0 = transmitter active, 1 = transmitter inactive
								Not used	free
								Not used	free
								Not used	free
								Not used	free
								Not used	free
								Not used	free
								Not used	free

IO-Link device parameters

With Leuze **Sensor Studio** (download at www.leuze.com), all sensors that are equipped with an IO-Link interface can be configured and diagnosed with the aid of the IO-Link service data.

Configuration

Enabling/locking teach button

This function can be used to lock the teach button to prevent tampering with the sensor setting.

Easy Tune

Activate and deactivate the Easy Tune function of the teach button.

L/D switching

Configuration of the switching logic of the sensor.

Logical function of the second switching output Q2 (pin 2)

Set the second switching output to the following functions:

- Switching output
- Inverted switching output
- Warning output

Switching delay

Activates or deactivates the switching delay function.

Function selection of the switching delay

The following functions can be selected:

- Start-up delay
- Switch-off delay
- Pulse stretching
- Pulse suppression

Time base of the switching delay

Defines the base of the switching delay, which, for the calculation of the switching delay, is multiplied by the factor. Possible time intervals for the time base are

- 1 ms
- 10ms
- 100ms
- 1000ms

Factor for time base of the switching delay

The time base is multiplied by this factor. If, for example, a time base of 10ms was selected and the factor is 5, the switching delay is 50ms.

IO-Link system commands

The switching threshold of the sensor can be set via commands; the process is referred to as teaching.

The teach level should be selected in accordance with the object that is to be detected. A teach event is always performed with a free light path to the reflector.

The following commands can be executed:

- **Teach 18% – increased sensitivity:**
Sensor sets the switching threshold to 18% of the free signal; is used for detecting, e.g., objects with openings.
- **Teach 28% – standard sensitivity:**
Sensor sets the switching threshold to 28% of the free signal; is used for detecting, e.g., pallets with different heights.
- **Light switching:**
Sets the switching logic to light switching (sensor switches if reflector is detected).
- **Dark switching:**
Sets the switching logic to dark switching (sensor switches if reflector is no longer detected).
- **Switch process data to analog value:**
Outputs the signal values as analog data in a graph.
Attention: The depiction of process data is intended only for service operation for testing the application, not as an analog output.
The function can only be deactivated by interrupting the voltage supply of the sensor.

The sensors offer no data storage and no ISDU support.



Teach procedure for sensor



Note

It is essential to teach the sensor before it is used for the first time!
The sensor is factory-set to the maximum operating range.

Before starting the teach procedure, align the light-band of the sensor with the center of the object and reflector!

	Teach	
Sensor sensitivity	Standard	Increased
Switching behavior	Sensor switches when 28 % of light-band is covered by object.	Sensor switches when 18 % of light-band is covered by object.
Typical application	Reliable detection of pallets	Detection of containers with openings / transparent objects
Setting	<p>Clear light path to reflector!</p> <p>Press teach button (2 to 7s) until both LEDs (green/yellow) flash synchronously.</p> <p>Release teach button – ready.</p> 	<p>Clear light path to reflector!</p> <p>Press teach button (7 to 12s) until both LEDs (green/yellow) flash alternately.</p> <p>Release teach button – ready.</p> 
Acknowledgment	Teach successful: Both LEDs (green/yellow) remain lit.	
	Teach not successful: Yellow LED flashes. Repeat teach procedure.	

Easy tune – Fine adjustment of sensor sensitivity (switching threshold)

Easy tune allows you to adjust the sensor sensitivity in small steps using the teach button during normal operation.

Increase sensitivity (reduce switching threshold)	Briefly press teach button (2 to 200ms) , sensitivity is increased slightly and switching threshold is reduced slightly.	<p>The sensor confirms button actuation by brief illumination (1x flash) of both LEDs.</p> 
Reduce sensitivity (increase switching threshold)	Press and hold teach button (200 ms to 2s) , sensitivity is reduced slightly and switching threshold is increased slightly.	

If the upper or lower end of the adjustment range is reached, both LEDs flash at a much higher frequency.

Light/dark switching – Adjustment of switching behavior of switching outputs

Light/dark switching	<p>Press teach button (> 12s) until green LED flashes.</p> <p>The yellow LED indicates the current setting of the switching outputs¹⁾:</p> <p>ON = Output OUT1 light switching Output OUT2 dark switching</p> <p>OFF = Output OUT1 dark switching Output OUT2 light switching</p> <p>Release teach button – switchover is complete.</p> <p>¹⁾For factory settings, see part number code</p> 
-----------------------------	---