

**HTU418B...W**

**Ultrasonic sensors, angled 90° with 1 switching output**

en 02-2016/05 50129815-01



**Dimensioned drawing**

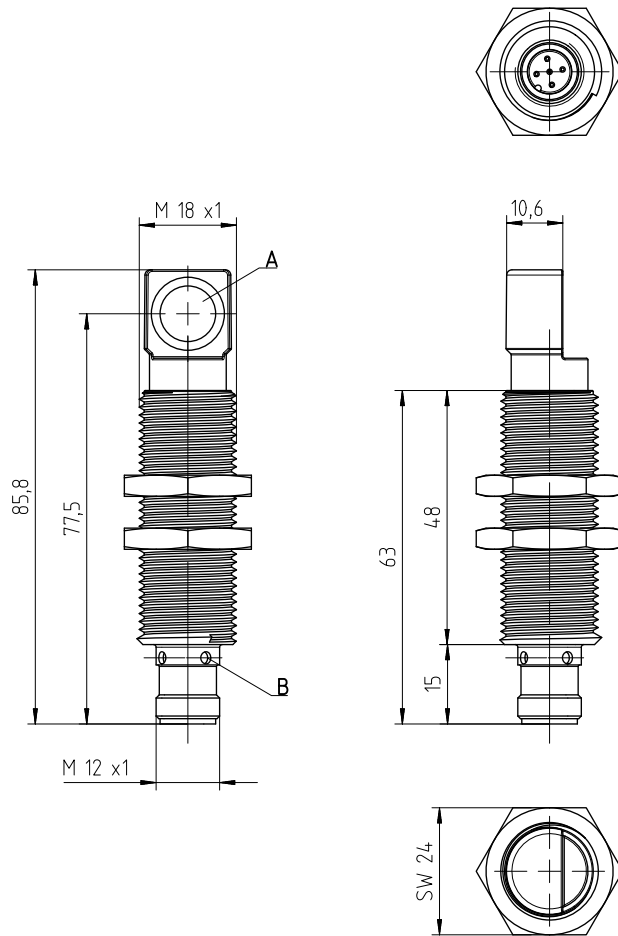

**A** Active sensor surface  
**B** Indicator diodes



**25 ... 400mm**  
**150 ... 1000mm**



- Function largely independent of surface properties, ideal for detection of liquids, bulk materials, transparent media, ...
- Sound exit less than 90° to the longitudinal axis
- Small dead zone at long scanning range
- Adjustment of the switching point can be taught
- NO/NC function reversible
- 1 switching output (PNP)
- Extra short construction

**Electrical connection**

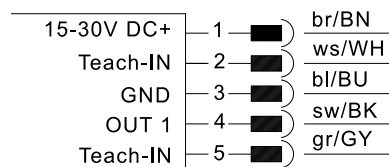

**Accessories:**

(available separately)

- Mounting systems
- Mounting adapter M18-M30: BTX-D18M-D30 (Part no. 50125860)
- Cables with M12 connector (K-D ...)
- Teach adapter PA1/XTSX-M12 (Part no. 50124709)

We reserve the right to make changes • DS\_HTU418BW4TX\_en\_50129815\_01.fm

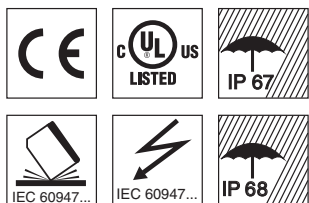

## Specifications

### Ultrasonic specifications

Scanning range <sup>1)</sup>  
 Adjustment range  
 Ultrasonic frequency  
 Typ. opening angle  
 Resolution  
 Direction of beam  
 Reproducibility  
 Switching hysteresis  
 Temperature drift

### HTU418B-400.W/4TX...

25 ... 400mm <sup>2)</sup>  
 25 ... 400mm  
 310kHz  
 9°  
 1mm  
 axial  
 ± 0.15% of end value <sup>1)</sup>  
 5mm <sup>1)</sup>  
 0.17%/K

### HTU418B-1000.W/4TX...

150 ... 1000mm <sup>3)</sup>  
 150 ... 1000mm  
 200kHz  
 16°  
 1mm  
 axial  
 ± 0.15% of end value <sup>1)</sup>  
 10mm <sup>1)</sup>  
 0.17%/K

### Timing

Switching frequency  
 Response time  
 Delay before start-up

7Hz  
 71ms  
 < 300ms

8Hz  
 62ms  
 < 300ms

### Electrical data

Operating voltage  $U_B$  <sup>4)</sup>  
 Residual ripple  
 Open-circuit current  
 Switching output  
 Function  
 Output current  
 Switching range adjustment

15 ... 30V DC (incl. ± 10% residual ripple)  
 ± 10% of  $U_B$   
 ≤ 50mA  
 1 x PNP transistor  
 NO contact, reversible  
 max. 150mA  
 teach-in (Pin 2):  
 for OUT1: connected to GND for 2 ... 7s  
 teach-in (pin 2):  
 for OUT1: connected to  $U_B$  for 2 ... 7s

Changeover NO/NC

### Indicators

Yellow LED  
 Yellow LED, flashing  
 Green LED

OUT1: object detected  
 teach-in / teaching error  
 object within the scanning range

### Mechanical data

Housing  
 Weight  
 Ultrasonic transducer  
 Connection type  
 Fitting position

all metal - brass, nickel-plated  
 50g  
 piezoceramic <sup>5)</sup>  
 M12 connector, 5-pin  
 any

### Environmental data

Ambient temp. (operation/storage)  
 Protective circuit <sup>6)</sup>  
 VDE safety class  
 Degree of protection  
 Standards applied  
 Certifications

-25°C ... +70°C/-30°C ... +85°C  
 1, 2, 3  
 III  
 IP 67 and IP 68  
 EN 60947-5-2  
 UL 508, C22.2 No.14-13 <sup>4) 7) 8)</sup>

- 1) At 20°C
- 2) Target: 20mm x 20mm plate
- 3) Target: 100mm x 100mm plate
- 4) For UL applications: for use in class 2 circuits according to NEC only
- 5) The ceramic material of the ultrasonic transducer contains lead zirconium titanate (PZT)
- 6) 1=short-circuit and overload protection, 2=polarity reversal protection, 3=wire break and inductive protection
- 7) These proximity switches shall be used with UL Listed Cable assemblies rated 30V, 0.5A min, in the field installation, or equivalent (categories: CYJV/CYJV7 or PVVA/PVVA7)
- 8) Ambient temperature 85°C. Use same voltage supply for all circuits.

## Remarks

### Operate in accordance with intended use!

- ☞ This product is not a safety sensor and is not intended as personnel protection.
- ☞ The product may only be put into operation by competent persons.
- ☞ Only use the product in accordance with the intended use.

## Diagrams

### HTU418B-400.W/...-M12

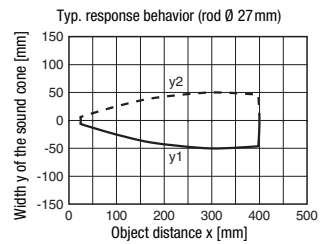
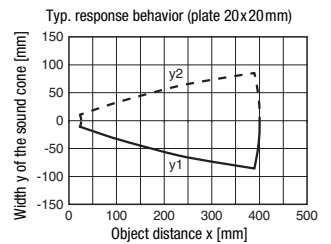

### HTU418B-1000.W/...-M12

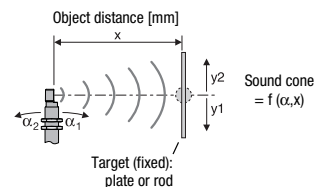
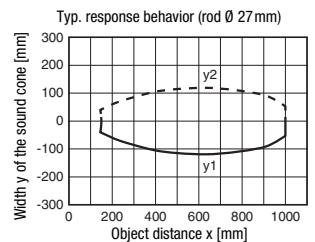
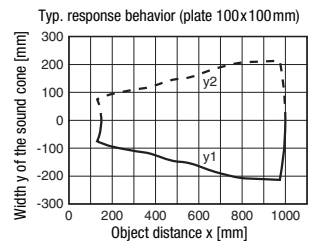
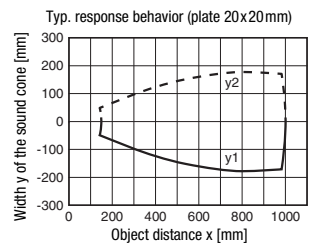

## HTU418B...W

## Ultrasonic sensors, angled 90° with 1 switching output

### Part number code

H	T	U	4	1	8	B	-	1	0	0	0	.	W	/	4	T	X	-	M	1	2
---	---	---	---	---	---	---	---	---	---	---	---	---	---	---	---	---	---	---	---	---	---

#### Operating principle

**HTU** Ultrasonic sensor, scanning principle, with background suppression

#### Series

**418B** 418B Series, cylindrical M18 construction

#### Scanning range in mm

**400** 25 ... 400

**1000** 150 ... 1000

#### Equipment (optional)

**W** Design with angle head of 90°

#### Pin assignment of connector pin 4 / black cable wire (OUT1)

**4** PNP output, NO contact preset

**P** PNP output, NC contact preset

**2** NPN output, NO contact preset

**N** NPN output, NC contact preset

#### Pin assignment of connector pin 2 / white cable wire (Teach-IN)

**T** Teach input

#### Pin assignment of connector pin 5 / gray cable wire (OUT2)

**4** PNP output, NO contact preset

**P** PNP output, NC contact preset

**2** NPN output, NO contact preset

**N** NPN output, NC contact preset

**X** Connection not assigned (n. c. - not connected)

#### Connection technology

**M12** M12 connector, 5-pin

## Order guide

The sensors listed here are preferred types; current information at [www.leuze.com](http://www.leuze.com).

	Designation	Part no.
<b>Scanning range</b>		
25 ... 400mm	HTU418B-400.W/4TX-M12	50129824
150 ... 1000mm	HTU418B-1000.W/4TX-M12	50129825

## Device functions and indicators

All settings on the sensor are taught-in via the **Teach-IN** input. Device status and switching states are indicated as follows by means of a yellow and green LED:

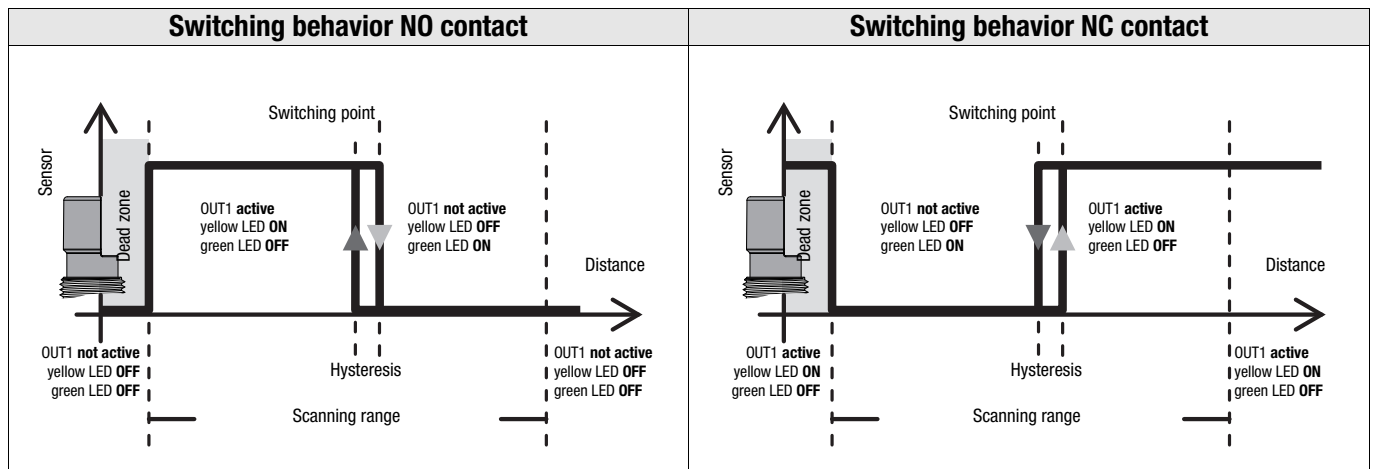

## Adjusting the switching point via the teach input

The switching point of the sensor is set to 400mm or 1000mm on delivery.

By means of a simple teach event, the switching point can be taught to an arbitrary distance within the scanning range. The Leuze **PA1/XTSX-M12** teach adapter can be used for this purpose. The adapter can also be used to easily switch the output function from NO contact to NC contact.

1-point teach
1. Place object at desired switching distance.
2. For the adjustment of <b>OUT1</b> , connect input <b>Teach-IN</b> to <b>GND</b> for 2 ... 7s (Leuze teach adapter: position "Teach-GND"). The current state of output <b>OUT1</b> is frozen during the teach event.
3. The <b>yellow LED flashes at 3Hz and is then ON</b> . The current object distance has been taught as the new switching point.
4. Error-free teach: LED states and switching behavior according to the diagram shown above. <b>Faulty teach</b> (object may be too close or too far away – please note scanning range): <b>yellow LED flashes at 5Hz</b> until an error-free teach event is performed. Output <b>OUT1</b> is inactive as long as there is a teach error.

## Adjusting the switching function (NC/NO) via the teach input

The switching function of the sensor is set to normally open (NO) on delivery.

If the switching function is changed, the switching output is changed to the opposite state (toggled).

Changeover of the switching function
1. To change the switching function, connect input <b>Teach-IN</b> to <b>U<sub>B</sub></b> for 2 ... 7s (Leuze teach adapter: position "Teach-U <sub>B</sub> "). The current state of output <b>OUT1</b> is frozen while the adjustment is made.
2. The <b>green and yellow LEDs flash alternately at 2Hz</b> . The switching function was changed over. The switching behavior corresponds to the diagram shown above.



### Notice!

Please note that **pin 2** and **pin 5** are internally **connected** within the sensor. The input is configured so that **the switching point is taught when GND is connected** and **the output function is reversed when U<sub>B</sub> is connected**.

**If no sensor action is desired, pin 2 and pin 5 must remain unconnected!**