

the sensor people

## DB 112 B Double Sheet Testing Unit



en 03-2014/06 50126540  
We reserve the right to  
make technical changes



© 2014

Leuze electronic GmbH + Co. KG

In der Braike 1

D-73277 Owen / Germany

Phone: +49 7021 573-0

Fax: +49 7021 573-199

<http://www.leuze.com>

[info@leuze.de](mailto:info@leuze.de)

<b>1</b>	<b>General information .....</b>	<b>2</b>
1.1	Explanation of symbols .....	2
1.2	Declaration of conformity .....	2
<b>2</b>	<b>Safety notices.....</b>	<b>3</b>
2.1	Safety standards .....	3
2.2	Intended use .....	3
2.3	Areas of application .....	3
2.4	Organisational measures .....	3
<b>3</b>	<b>Device overview .....</b>	<b>4</b>
<b>4</b>	<b>Specifications.....</b>	<b>6</b>
<b>5</b>	<b>Mounting the transmitter and receiver.....</b>	<b>7</b>
<b>6</b>	<b>Electrical connection .....</b>	<b>8</b>
<b>7</b>	<b>Commissioning .....</b>	<b>9</b>
<b>8</b>	<b>Operation - inputs and outputs.....</b>	<b>12</b>
<b>9</b>	<b>Diagnosis in the case of error .....</b>	<b>13</b>
<b>10</b>	<b>Application-specific extension types.....</b>	<b>14</b>
10.1	VDB 112 B/6.2N - Fixed switching threshold .....	14
10.2	VDB 112B/6.12P - without teach button in the cover .....	15

# 1 General information

## 1.1 Explanation of symbols

The symbols used in this technical description are explained below.



**Attention!**

*This symbol appears before text passages which must absolutely be observed. Failure to heed this information can lead to injuries to personnel or damage to the equipment.*



**Notice!**

*This symbol indicates text passages containing important information.*

## 1.2 Declaration of conformity

The DB 112 B double sheet testing unit sensor system has been developed and manufactured in adherence with the applicable European standards and directives.



**Notice!**

*The corresponding declaration of conformity can be requested from the manufacturer.*

The manufacturer of the product, Leuze electronic GmbH + Co. KG in D-73277 Owen/Teck, possesses a certified quality assurance system in accordance with ISO 9001.



For UL applications:  
only for use in "Class 2" circuits according to NEC.

## 2 Safety notices

### 2.1 Safety standards

The DB 112 B double sheet testing unit has been developed subject to the applicable safety standard EN 60947-5-2 (IEC 60947-5-2).

### 2.2 Intended use

The DB 112 B double sheet testing unit has been conceived as a monitoring device mainly for paper working machines. It monitors incoming paper sheets at machines designed to process single sheets. It is used to detect and signal double sheets in the sheet feeder during operation.



#### **Attention!**

***The DB 112 B is not a safety module acc. to EU machine guidelines.***

*The protection of machine and the device cannot be guaranteed if the device is operated in a manner not corresponding to its intended use.*

*Access to or changes on the device, except where expressly described in this manual, are not authorised.*

### 2.3 Areas of application

Double sheets made of the following materials can be reliably detected by the DB 112 B:

- Paper
- Plastic
- Metal foils

For paper, the measurement range is 20g/m<sup>2</sup> (airmail paper) to 800g/m<sup>2</sup> (homogeneous cardboard).

### 2.4 Organisational measures

All entries in this operating manual must be heeded, in particular those in the section "Safety notices" and "Commissioning".

Keep this technical description in a safe place. It should be accessible at all times.

#### **Safety regulations**

Observe the locally applicable safety regulations.

#### **Qualified personnel**

Mounting, commissioning and maintenance of the device may only be carried out by qualified personnel.

### 3 Device overview

The ultrasonic double sheet testing system consists of a VDB 112 B... analysis amplifier and a pair of DB 112 UP ultrasonic sensors.

It detects and checks primarily paper, plastic and metal foils which are guided in by feeders. The device functions as a presence monitor by constantly applying a signal at the **single sheet** output when an object is located between the sensors. It functions as a double sheet testing unit by comparing each sheet with the stored reference value. A detected double sheet is signalled at the **double sheet** output.

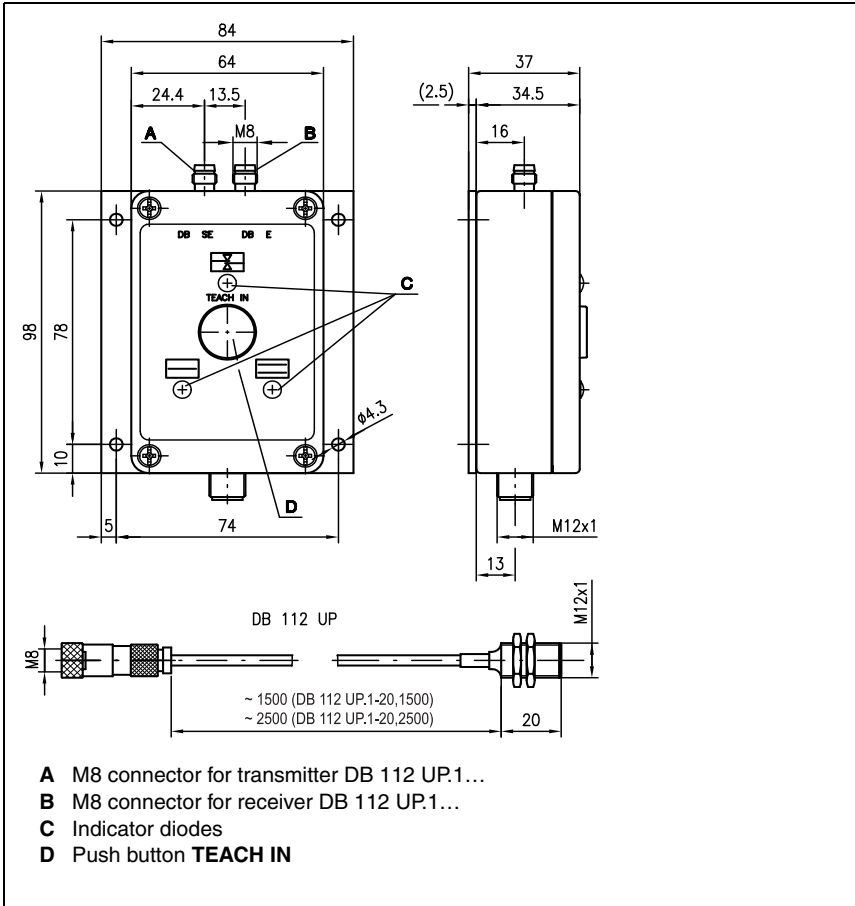

Figure 3.1: Device overview - dimensions

**Controls and indicators**

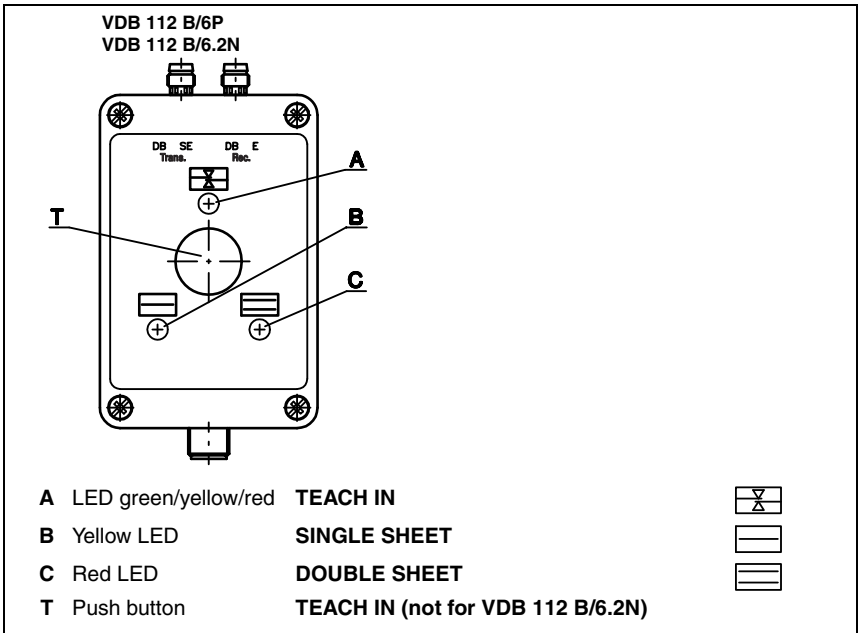

Figure 3.2: Controls and indicators

**Order guide**

**Designation**

Sensor pair M12 x 21 mm, cable length 1.5m  
 Sensor pair M12 x 21 mm, cable length 2.5m  
 Amplifier (positive logic)

**Model**

DB 112 UP.1-20,1500  
 DB 112 UP.1-20,2500  
 VDB 112 B/6P

**Part No.**

501 08999  
 501 09000  
 501 07002

**Accessories**

**Designation**

Cable 5m, PVC, 5-pin, with M12 connectors

**Model**

K-D M12A-5P-5m-PVC

**Part No.**

501 04557

## 4 Specifications

### *Technical data for sensor DB 112 UP*

#### Sensor data

Operating range	15 ... 30mm
Converter frequency	300kHz $\pm 5\%$
Ultrasonic lobe	approx. 12°

#### Mechanical data

Housing	nickel-faced brass
Weight	30g
Connection type	1.5/2.5m cable with M8 connector, 3-pin, bending radius $r > 25\text{mm}$

### *Technical data for analysis amplifier VDB 112 B/...*

#### Timing

Switching frequency	200Hz
Input pulse	min. 5ms
Delay before start-up	$\leq 300\text{ms}$

#### Electrical data

Operating voltage $U_B$ <sup>1)</sup>	18 ... 30VDC (incl. residual ripple)
Residual ripple	$\leq 15\%$ of $U_B$
Open-circuit current	$\leq 75\text{mA}$
Switching output	2 push-pull switching outputs <sup>2)</sup>
Function	single sheet detected, or $\geq 1$ sheet double sheet detected, or $\geq 2$ sheets
Signal voltage high/low	$\geq (U_B - 2\text{V}) / \leq 2\text{V}$
Output current	max. 100mA per output
Teach input	$R_{in} = 10\text{k}\Omega$
TEACH-IN active/not active <sup>3)</sup>	.../...P (PNP): $\geq 10\text{V} / \leq 2\text{V}$ or not connected .../...N (NPN): $\leq 2\text{V} / \geq 10\text{V}$ or not connected
TEACH IN duration	max. 100ms
TEACH IN delay <sup>4)</sup>	approx. 300ms

#### Indicators

LED green A	double sheet testing unit ready
LED A yellow	teach-in process
LED A red flashing	error (see chapter 9)
LED yellow B	single sheet detected
LED red C	double sheet detected

#### Mechanical data

Housing	aluminium, black powder-coated
Weight	400g
Connection type	M12 connector, 5-pin

#### Environmental data

Ambient temp. (operation/storage)	0°C ... +50°C / -40°C ... +70°C
Protective circuit <sup>5)</sup>	1,2,3
VDE safety class	III
Protection class	IP 65
Standards applied	EN 60947-5-2
Certifications	UL 508, C22.2 No.14-13 <sup>1) 6)</sup>

1) For UL applications: only for use in "Class 2" circuits according to NEC.

2) Function: .../...P = active high (+24V); inactive low (0V),  
.../...N = active low (0V); inactive high (+24V).

The push-pull switching outputs must not be connected in parallel

3) Setting the Teach IN input disables the TEACH IN button (see page 10)

4) Only applies for automatic calibration during sheet movement (automatic teach)

5) 1=transient protection, 2=polarity reversal protection, 3=short circuit protection

6) These proximity switches shall be used with UL Listed Cable assemblies rated 30V, 0.5A min, in the field installation, or equivalent (categories: CYJV/CYJV7 or PVVA/PVVA7)



## 5 Mounting the transmitter and receiver

The transmitter and receiver (DB 112 UP) are identical in construction and are to be mounted according to the table in figure 5.1 at an angle which varies depending on the sheet material. A larger angle of inclination increases the flutter range; e.g. with a 35° pitch, flutter is permissible within 50% of the measurement field. The distance between transmitter and receiver must be at least 15mm and can be max. 30mm.

Ensure that alignment is exact ( $\pm 1^\circ$ ). If the alignment does not run along the axis, the working range is reduced.



**Notice!**

When aligning the transmitter and receiver, take care to ensure the most exact alignment possible. See "Alignment mode" on page 9. To ensure proper function, the sensors must be inclined by the angle "B" towards the vertical.

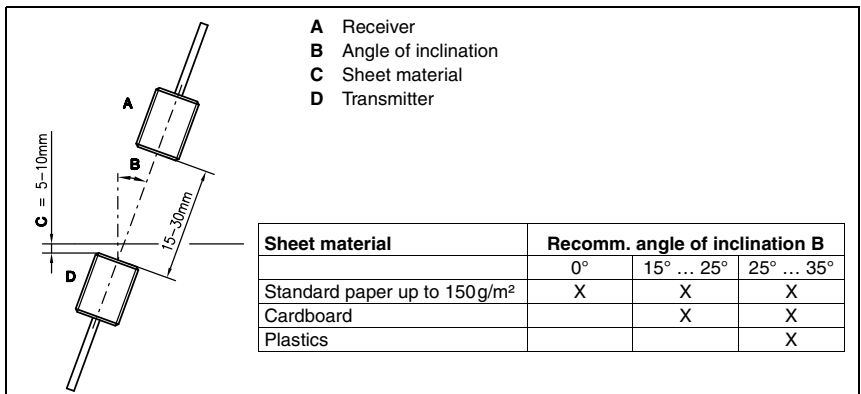

Figure 5.1: Mounting the transmitter and receiver

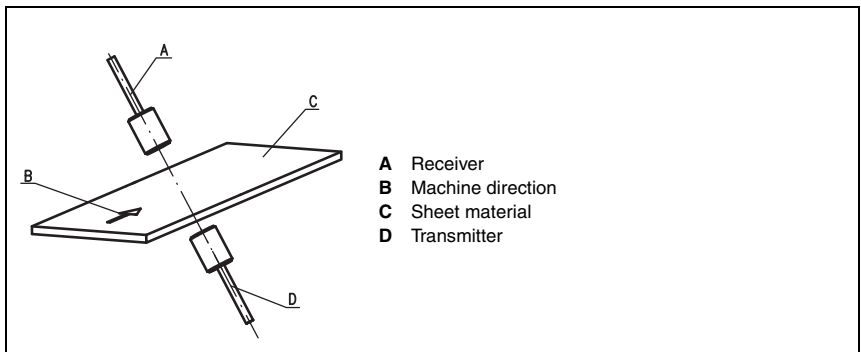

Figure 5.2: Recommended configuration for maximum functionality

## 6 Electrical connection

Connect the transmitter and receiver at the appropriate M8 connectors of the VDB 112 B/... analysis amplifier.

Connect the analysis amplifier acc. to connection diagram (figure 6.1).

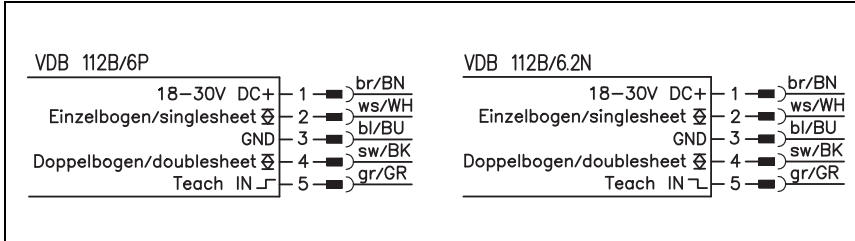

Figure 6.1: Connection diagram VDB 112 B/...

### ***Circuit logic***

**VDB 112B/...P -> positive logic**

**VDB 112B/...N -> negative logic**

## 7 Commissioning





**Notice!**

If the indicators flash during the initial commissioning, a calibration must first be performed on a single sheet.



First apply operating voltage. An **alignment mode** is available for commissioning. This can be used to check the alignment of the transmitter and receiver.



**Alignment mode**

Press the **TEACH IN** button for > 5s and < 10s      LEDs  and  flash synchronously at 3Hz



LED  <b>green:</b>	Alignment OK	Exit: press the <b>TEACH IN</b> button < 5s	↕
---	--------------	---	---

LED  <b>yellow:</b>	Alignment critical	Align transmitter and receiver until LED  is green. Only then is it possible to exit alignment mode! Extraordinary exiting of alignment mode is possible only by means of Power OFF!	↕
--	--------------------	---	---

LED  <b>red:</b>	Alignment bad	Align transmitter and receiver until LED  is green. Only then is it possible to exit alignment mode! Extraordinary exiting of alignment mode is possible only by means of Power OFF!	↕
---	---------------	---	---



**Notice!**

After exiting alignment mode, it is **absolutely necessary to perform a calibration**.

**Calibrating on the material to be detected**



For reliable detection of double layers of the medium being processed, it is always necessary to perform a calibration on a single sheet of the medium.



Calibration of the material to be detected can be performed by either pressing the **TEACH IN** button on the analysis amplifier for 0.3s to 5s or by means of a control command at the **Teach IN** input (pin 5).

**Notice!**

Setting the **Teach IN** input (pin 5) disables the **TEACH IN** button. As soon as a signal is applied once via the **Teach IN** input for the purpose of calibration, the **TEACH IN** button remains inactive (disabled) until the next Power On.

During the calibration process, LED  illuminates yellow.

If the calibration was successful, LED  illuminates green and LED  yellow. The **single sheet** output is activated. The reference value remains stored until the next calibration process.

If the calibration process was not successful, LED  flashes red and LED  illuminates red. The **double sheet** output is activated.

**Notice!**

Causes of unsuccessful calibration include e.g.:

- More than 1 sheet between the sensors.
- Unsuitable sheet material, e.g. due to lamination or coating, too thin, too thick, or air pockets present.
- Pitch to sensors too low.

The VDB 112 B analysis amplifier can be operated in 3 different operating modes (teach modes):

1. **Standard mode:**

Teach with intelligent transmitter/receiver control for covering a wide spectrum of materials.

2. **Automatic teach:**

300ms after sheet detection by the ultrasonic sensors, teach-in occurs automatically. In this operating mode, manual or external teaching is not necessary. A new automatic teach-in is carried out if the ultrasonic path is clear for more than 2s.

3. **Fixed switching threshold:**

This operating mode is recommended when the process does not permit manual or external teaching. In this operating mode, the variety of materials to be detected is limited.

**Selecting the operating mode (teach mode)**

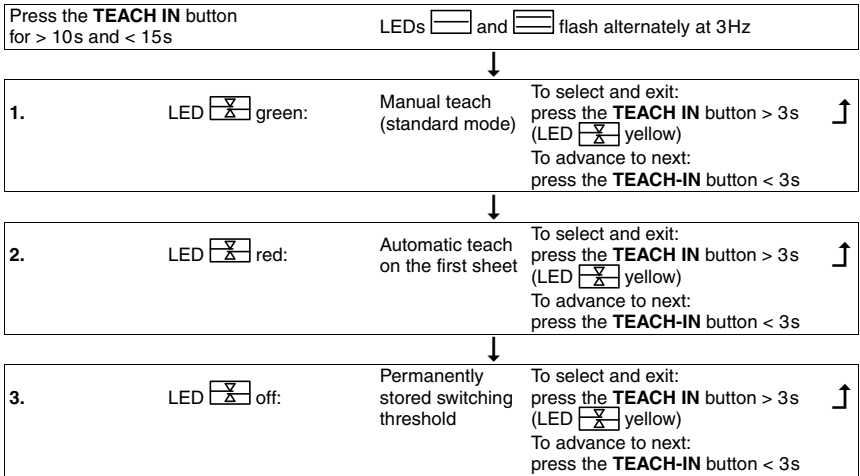

**Attention!**

*After selecting the operating mode (teach mode), a calibration must be performed!*

### 8 Operation - inputs and outputs

The analysis unit VDB 112 B/... continuously signals the situation occurring between the sensors to two outputs.

The **single sheet output** (pin 2) is activated as long as **one or more sheets** are located in the measurement field.

The **double sheet output** (pin 4) is activated as long as **two or more sheets** are located in the measurement field.





**Notice!**

*For reliable operation, **it is essential that calibration** be performed on the material to be detected. See "Calibrating on the material to be detected" on page 10.*

## 9 Diagnosis in the case of error

The device LEDs indicate the following error states:

LED 	LED 	LED 	Meaning	Cause	Remedy
<b>red flashing (6 Hz)</b>	<b>yellow flashing (6 Hz)</b>		Double-sheet control not calibrated		Perform calibration
<b>red flashing (6 Hz)</b>		<b>red</b>	No single sheet detected during calibration	No sheet inserted or double sheet inserted	Calibrate on single sheet
<b>red flashing (6 Hz)</b>		<b>red flashing (6 Hz)</b>	Amplifier detects insufficient input signal when device switched on	Sheet between the sensors or sensors not connected	Remove sheet and acknowledge with the TEACH IN button
<b>red flashing (6 Hz)</b>		<b>red flashing (6 Hz)</b>	Amplifier detects excessively high noise level when device switched on	Extreme background noise	Dampen background noises, e.g. using foam
	<b>rapid yellow flashing</b>	<b>rapid red flashing</b>	Current at output too high	Short circuit	Switch off voltage, check wiring
<b>red flashing (3 Hz)</b>		<b>red</b>	Fatal memory error	Defect	Have repaired by Leuze electronic

## 10 Application-specific extension types

The amplifier types described below are used for the adaptation to specific applications. They are used instead of the standard amplifier types.

### 10.1 VDB 112 B/6.2N - Fixed switching threshold

This amplifier corresponds to the VDB 112B/6P with regard to the technical and electrical data. The software is adapted to a special customer application.

No calibration is needed for the material to be detected as a fixed switching threshold for double sheet detection is implemented in the amplifier.

The detection range covers papers between 40g/m<sup>2</sup> and 450g/m<sup>2</sup>.



Designation	Model	Part No.
Amplifier (negative logic) - fixed switching threshold	VDB 112 B/6.2N	501 07003



#### Notice!

*The VDB 112 B/6.2N has no TEACH-IN button. In order to enter alignment mode if required, the 2-pin pin strip directly on the PCB may be bridged for >5s. Afterwards, alignment can be carried out as described under "Alignment mode" in chapter 7.*

The device LEDs indicate the following error states:

LED	LED	LED	Meaning	Cause	Remedy
					
red flashing (6Hz)		red flashing (6Hz)	Amplifier detects insufficient input signal when device switched on	Sheet between the sensors or sensors not connected	Remove sheet
red flashing (6Hz)		red flashing (6Hz)	Amplifier detects excessively high noise level when device switched on	Extreme background noise	Dampen background noises, e.g. using foam
	rapid yellow flashing	rapid red flashing	Current at output too high	Short circuit	Switch off voltage, check wiring
red flashing (3Hz)		red	Fatal memory error	Defect	Have repaired by Leuze electronic

In the case of VDB112B/6.2N, the operating voltage must be interrupted briefly in order to reset the error message.



## 10.2 VDB 112B/6.12P - without teach button in the cover

This amplifier corresponds to the VDB 112B/6P with regard to technical and electrical data as well as the software. The devices are delivered with "manual teach" operating mode.

The calibration on the material to be detected is performed using pin 5 on the M12 connector.

Designation	Model	Part No.
Amplifier (positive logic) without teach button in the cover	VDB 112 B/6.12P	501 09780



**Notice!**

*To enter alignment mode, the 2-pin pin strip directly on the PCB can be bridged for longer than 5s. Afterwards, alignment can be carried out as described in chapter 7. Error states see chapter 9 "Diagnosis in the case of error".*