

 **Leuze electronic**

the sensor people

SMART  
**SENSOR**  
BUSINESS

## **CML 720i EX**

Measuring light curtain

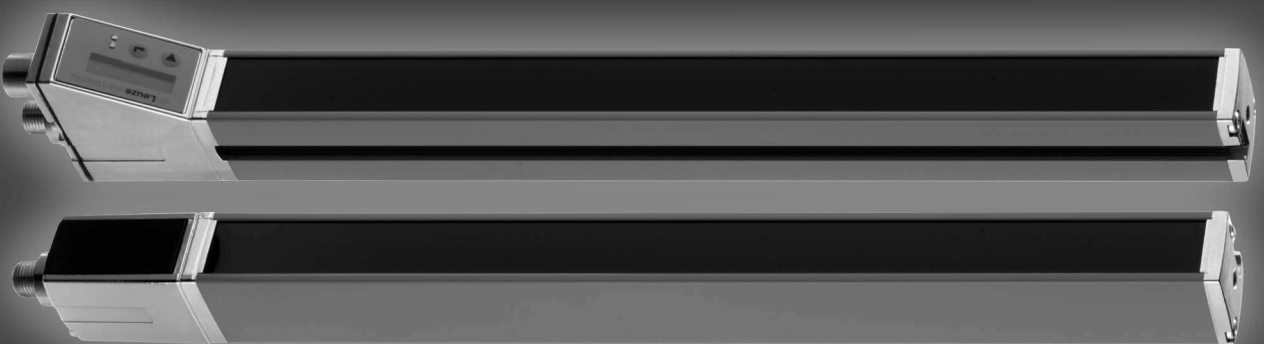

Leuze electronic GmbH + Co. KG

In der Braike 1

D-73277 Owen / Germany

Phone: +49 7021 573-0

Fax: +49 7021 573-199

<http://www.leuze.com>

[info@leuze.de](mailto:info@leuze.de)

|          |  |           |
|----------|--|-----------|
| <b>1</b> | <b>About this document</b>   | <b>7</b>  |
| 1.1      | Used symbols and signal words                                      | 7         |
| 1.2      | Terms and abbreviations  | 7         |
| <b>2</b> | <b>Safety</b>  | <b>10</b> |
| 2.1      | Intended use   | 10        |
| 2.2      | Foreseeable misuse   | 10        |
| 2.3      | Competent persons  | 11        |
| 2.4      | Exemption of liability   | 11        |
| 2.5      | Notices for the safe use of sensors in potentially explosive areas | 11        |
| <b>3</b> | <b>Device description</b>  | <b>13</b> |
| 3.1      | General information  | 13        |
| 3.2      | General performance characteristics                                | 13        |
| 3.3      | Connection system  | 14        |
| 3.4      | Display elements   | 14        |
| 3.4.1    | Operation indicators on the receiver control panel                 | 14        |
| 3.4.2    | Display on the receiver control panel                              | 15        |
| 3.4.3    | Operating indicators on the transmitter                            | 16        |
| 3.5      | Operating elements on the receiver control panel                   | 16        |
| 3.6      | Menu structure of the receiver control panel                       | 17        |
| 3.7      | Menu navigation on the receiver control panel                      | 18        |
| 3.7.1    | Meaning of the display icons                                       | 18        |
| 3.7.2    | Level display  | 19        |
| 3.7.3    | Menu navigation  | 19        |
| 3.7.4    | Editing value parameters   | 19        |
| 3.7.5    | Editing selection parameters                                       | 21        |
| <b>4</b> | <b>Functions</b>   | <b>22</b> |
| 4.1      | Beam modes   | 22        |
| 4.1.1    | Parallel   | 22        |
| 4.1.2    | Diagonal   | 22        |
| 4.1.3    | Crossed-beam   | 23        |
| 4.2      | Measurement beam sequence  | 24        |
| 4.3      | Beam-stream  | 25        |
| 4.4      | Evaluation functions   | 26        |
| 4.5      | Hold function  | 26        |
| 4.6      | Blanking   | 27        |
| 4.7      | Power-Up Teach   | 28        |
| 4.8      | Smoothing  | 29        |
| 4.9      | Cascading/triggering   | 30        |
| 4.9.1    | External triggering  | 31        |
| 4.9.2    | Internal triggering  | 32        |
| 4.10     | Block evaluation of beam areas                                     | 34        |
| 4.10.1   | Defining beam area   | 34        |
| 4.10.2   | Autosplitting  | 34        |
| 4.10.3   | Mapping beam area to switching output                              | 34        |
| 4.10.4   | Teach height area  | 36        |
| 4.11     | Switching outputs  | 37        |
| 4.11.1   | Light/dark switching   | 37        |
| 4.11.2   | Time functions   | 37        |
| 4.12     | Interference suppression (filter depth)                            | 38        |

|           |  |           |
|-----------|--|-----------|
| <b>5</b>  | <b>Applications</b>  | <b>39</b> |
| 5.1       | Height measurement   | 39        |
| 5.2       | Object measurement   | 40        |
| 5.3       | Width measurement, orientation detection   | 41        |
| 5.4       | Contour measurement  | 42        |
| 5.5       | Gap control/gap measurement  | 42        |
| 5.6       | Hole recognition   | 43        |
| <b>6</b>  | <b>Mounting and installation</b>   | <b>44</b> |
| 6.1       | Mounting the light curtain   | 44        |
| 6.2       | Definition of directions of movement   | 45        |
| 6.3       | Fastening via sliding blocks   | 46        |
| 6.4       | Fastening via swivel mount   | 46        |
| 6.5       | Fastening via swiveling mounting brackets  | 47        |
| <b>7</b>  | <b>Electrical connection</b>   | <b>48</b> |
| 7.1       | Shielding and line lengths   | 48        |
| 7.1.1     | Shielding  | 48        |
| 7.1.2     | Cable lengths for shielded cables  | 50        |
| 7.2       | Connection and interconnection cables  | 51        |
| 7.3       | Device connections   | 51        |
| 7.4       | Digital inputs/outputs on connection X1  | 51        |
| 7.5       | Electrical connection – CML 720i Ex with CANopen or IO-Link interface              | 52        |
| 7.5.1     | Pin assignment – CML 720i Ex with CANopen or IO-Link interface                     | 53        |
| 7.5.2     | X2 pin assignment – CML 720i Ex with CANopen interface                             | 54        |
| 7.6       | Electrical supply  | 54        |
| <b>8</b>  | <b>Starting up the device - Basic configuration</b>                                | <b>55</b> |
| 8.1       | Aligning transmitter and receiver  | 55        |
| 8.2       | Teaching the environmental conditions  | 57        |
| 8.2.1     | Teach via receiver control panel   | 57        |
| 8.2.2     | Teaching via a control signal from the control                                     | 59        |
| 8.3       | Check alignment  | 60        |
| 8.4       | Setting the function reserve   | 60        |
| 8.5       | Extended configurations on the receiver control panel menu                         | 60        |
| 8.5.1     | Define digital inputs/outputs  | 60        |
| 8.5.2     | Inversion of the switching behavior (light/dark switching)                         | 63        |
| 8.5.3     | Defining the filter depth  | 63        |
| 8.5.4     | Defining the display properties  | 64        |
| 8.5.5     | Changing the language  | 65        |
| 8.5.6     | Product information  | 65        |
| 8.5.7     | Reset to factory settings  | 65        |
| <b>9</b>  | <b>Starting up the device - IO-Link interface</b>                                  | <b>66</b> |
| 9.1       | Defining IO-Link device configurations on the receiver control panel               | 66        |
| 9.2       | Defining configurations via the IO-Link master module of the PLC-specific software | 66        |
| 9.3       | Parameter/process data for IO-Link   | 67        |
| <b>10</b> | <b>Starting up the device - CANopen interface</b>                                  | <b>82</b> |
| 10.1      | Defining the CANopen basic configuration on the receiver control panel             | 82        |
| 10.2      | Defining configurations via the PLC-specific software of the CANopen master        | 82        |
| 10.3      | Parameter- / process data for CANopen  | 83        |

|           |   |            |
|-----------|---|------------|
| <b>11</b> | <b>Example configurations</b>   | <b>99</b>  |
| 11.1      | Example configuration - Reading out 64 beams (beam-stream)                    | 99         |
| 11.1.1    | Configuration of beam-stream process data via IO-Link interface               | 99         |
| 11.1.2    | Configuration of beam-stream process data via CANopen interface               | 99         |
| 11.2      | Example configuration - Mapping of beams 1 ... 32 to output pin 2             | 100        |
| 11.2.1    | Configuration of area/output mapping (general)                                | 100        |
| 11.2.2    | Configuration of an area/output mapping via IO-Link interface                 | 101        |
| 11.2.3    | Configuration of area/output mapping via CANopen interface                    | 101        |
| 11.3      | Example configuration - Hole recognition                                      | 102        |
| 11.3.1    | Configuration of hole recognition via IO-Link interface                       | 102        |
| 11.3.2    | Configuration of hole recognition via CANopen interface                       | 103        |
| 11.4      | Example configuration - Activating and deactivating blanking areas            | 103        |
| 11.4.1    | Configuration of blanking areas (general)                                     | 103        |
| 11.4.2    | Configuration of blanking areas via IO-Link interface                         | 103        |
| 11.4.3    | Configuration of blanking areas via CANopen interface                         | 104        |
| 11.5      | Example configuration - smoothing   | 104        |
| 11.5.1    | Smoothing configuration (general)   | 104        |
| 11.5.2    | Configuration of smoothing via IO-Link interface                              | 105        |
| 11.5.3    | Configuration of smoothing via CANopen interface                              | 105        |
| 11.6      | Example configuration - Cascading   | 105        |
| 11.6.1    | Configuration of a cascading arrangement (general)                            | 105        |
| 11.6.2    | Configuration of a cascading arrangement via IO-Link interface                | 107        |
| 11.6.3    | Configuration of a cascading arrangement via CANopen interface                | 109        |
| <b>12</b> | <b>Connecting to a PC – <i>Sensor Studio</i></b>                              | <b>111</b> |
| 12.1      | System requirements   | 112        |
| 12.2      | Installing <i>Sensor Studio</i> configuration software and IO-Link USB master | 112        |
| 12.2.1    | Installing the <i>Sensor Studio</i> FDT frame                                 | 112        |
| 12.2.2    | Installing drivers for IO-Link USB master                                     | 113        |
| 12.2.3    | Connecting IO-Link USB master to the PC                                       | 113        |
| 12.2.4    | Connect the IO-Link USB master to the light curtain                           | 113        |
| 12.2.5    | Installing the DTM and IODD   | 114        |
| 12.3      | Starting the <i>Sensor Studio</i>   | 115        |
| 12.4      | Short description of the <i>Sensor Studio</i> configuration software          | 117        |
| 12.4.1    | FDT frame menu  | 117        |
| 12.4.2    | <i>IDENTIFICATION</i> function  | 117        |
| 12.4.3    | <i>CONFIGURATION</i> function   | 117        |
| 12.4.4    | <i>PROCESS</i> function   | 118        |
| 12.4.5    | <i>DIAGNOSIS</i> function   | 119        |
| 12.4.6    | Exiting <i>Sensor Studio</i>  | 119        |
| <b>13</b> | <b>Troubleshooting</b>  | <b>120</b> |
| 13.1      | What to do in case of error?  | 120        |
| 13.2      | Operating displays of the LEDs  | 120        |
| 13.3      | Error codes in the display  | 121        |
| <b>14</b> | <b>Care, maintenance and disposal</b>   | <b>124</b> |
| 14.1      | Cleaning  | 124        |
| 14.2      | Servicing   | 124        |
| 14.2.1    | Firmware update   | 124        |
| 14.3      | Disposing   | 124        |
| <b>15</b> | <b>Service and support</b>  | <b>125</b> |

|           |   |            |
|-----------|---|------------|
| <b>16</b> | <b>Technical data</b> .....                                       | <b>126</b> |
| 16.1      | General specifications .....                                      | 126        |
| 16.2      | Timing .....  | 129        |
| 16.3      | Minimum object diameter for stationary objects .....              | 131        |
| 16.4      | Dimensional drawings .....  | 132        |
| 16.5      | Dimensional drawings: Accessories .....                           | 133        |
| <b>17</b> | <b>Ordering information and accessories</b> .....                 | <b>136</b> |
| 17.1      | Nomenclature .....  | 136        |
| 17.2      | Accessories – CML 720i Ex with CANopen or IO-Link interface ..... | 137        |
| 17.3      | Accessories - fastening technology .....                          | 140        |
| 17.4      | Accessories – PC connection .....                                 | 140        |
| 17.5      | Scope of delivery .....   | 141        |
| <b>18</b> | <b>EC Declaration of Conformity</b> .....                         | <b>142</b> |

## 1 About this document

These original operating instructions contain information regarding the proper use of the CML 700i measuring light curtain series. It is included in the delivery contents.

### 1.1 Used symbols and signal words

Table 1.1: Warning symbols, signal words and symbols





|   |   |
|---|---|
|  | Pay attention to passages marked with this symbol. Failure to observe the provided instructions could lead to personal injury or damage to equipment. |
| <b>NOTICE</b>   | Signal word for property damage<br>Indicates dangers that may result in property damage if the measures for danger avoidance are not followed.        |
|  | Symbol for tips<br>Text passages with this symbol provide you with further information.   |
|  | Symbols for action steps<br>Text passages with this symbol instruct you to perform actions.   |

Table 1.2: Operating on the display

|   |                      |  |
|---|----------------------|--|
|    | <b>Main Settings</b> | Bold text<br>Indicates that this field is currently selected and appears highlighted in the receiver display.    |
|  | Digital IOs          | Normal text<br>Indicates that this field is not currently selected (is not highlighted in the receiver display). |

### 1.2 Terms and abbreviations

Table 1.3: Terms and abbreviations

|   |  |
|---|--|
| DTM ( <b>D</b> evice <b>T</b> ype <b>M</b> anager)                  | Software device manager of the sensor  |
| IO  | Input Output   |
| FB ( <b>F</b> irst <b>B</b> eam)                                    | First beam   |
| FIB ( <b>F</b> irst <b>I</b> nterrupted <b>B</b> eam)               | First interrupted beam   |
| FNIB ( <b>F</b> irst <b>N</b> ot <b>I</b> nterrupted <b>B</b> eam)  | First uninterrupted beam   |
| FDT ( <b>F</b> ield <b>D</b> evice <b>T</b> ool)                    | Software frame for management of device managers (DTM)   |
| LB ( <b>L</b> ast <b>B</b> eam)                                     | Last beam  |
| LIB ( <b>L</b> ast <b>I</b> nterrupted <b>B</b> eam)                | Last interrupted beam  |
| LNIB ( <b>L</b> ast <b>N</b> ot <b>I</b> nterrupted <b>B</b> eam)   | Last uninterrupted beam  |
| TIB ( <b>T</b> otal <b>I</b> nterrupted <b>B</b> eams)              | Number of all interrupted beams  |
| TNIB ( <b>T</b> otal <b>N</b> ot <b>I</b> nterrupted <b>B</b> eams) | Number of all uninterrupted beams (TNIB = n - TIB)   |
| n   | Number of all logical beams of a light curtain; dependent on the selected measurement field length and resolution as well as the beam mode (parallel- / diagonal- / crossed-beam scanning) |
| EDS   | Electronic Data Sheet (EDS file for CANopen interface)<br>Description of the device for the control  |

|   |  |
|---|--|
| GSD                                       | Device master data file (GSD file for Profibus interface)<br>Description of the device for the control   |
| IODD                                      | IO Device Description (IODD file for IO-Link interface)<br>Description of the device for the control   |
| GUI (Graphical User Interface)            | Graphical user interface   |
| RTU                                       | Remote Terminal Unit (serial RS 485 Modbus RTU mode)   |
| PLC                                       | Programmable Logic Control<br>(corresponds to Programmable Logic Controller (PLC))   |
| Response time per beam                    | Length of time for the evaluation of a beam  |
| Resolution                                | The minimum size of an object that can be reliably detected. With parallel-beam evaluation, the smallest object to be detected corresponds to the sum of beam spacing and optic diameter.  |
| Delay before start-up                     | Duration between the switching on of the supply voltage and the start of operational readiness of the light curtain  |
| Function reserve (sensitivity adjustment) | Ratio of the optical reception power set during the teach event and the minimum light quantity required to switch the individual beam. This compensates for the light attenuation caused by dirt, dust, smoke, humidity and vapor.<br>High function reserve = low sensitivity<br>Low function reserve = high sensitivity |
| Meas. field length                        | Optical detection range between the first and last beam  |
| Beam spacing                              | Center-to-center spacing between two beams   |
| Cycle time                                | Sum of the response times of all beams of a light curtain plus the duration of the internal evaluation.<br>Cycle time =<br>number of beams x response time per beam + evaluation time  |



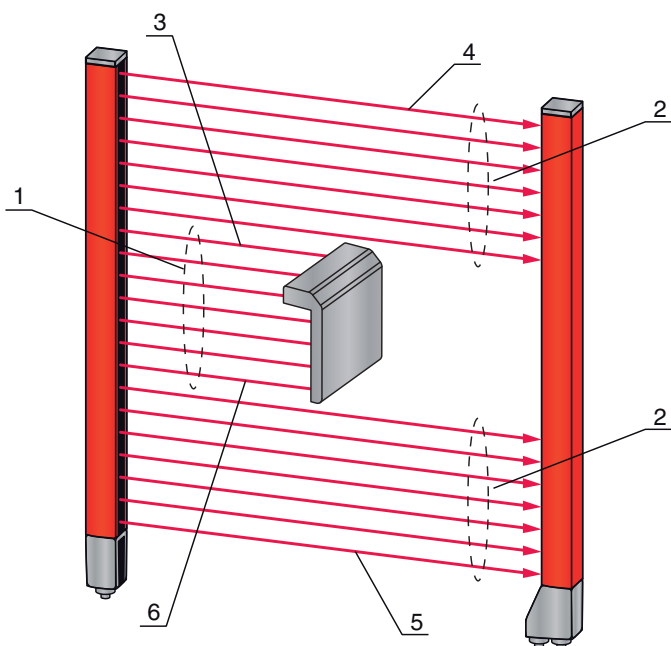

- 1 TIB (Number of all interrupted beams)
- 2 TNIB (Number of all uninterrupted beams)
- 3 LIB (Last interrupted beam )
- 4 LNIB (Last uninterrupted beam)
- 5 FNIB (First uninterrupted beam)
- 6 FIB (First interrupted beam)

Figure 1.1: Definition of terms

## 2 Safety

This sensor was developed, manufactured and tested in line with the applicable safety standards. It corresponds to the state of the art.

### 2.1 Intended use

The device is designed as a measuring and object-detecting, configurable, multi-sensor unit.

#### Areas of application

The measuring light curtain is designed for the measurement and detection of objects for the following areas of application in handling and warehousing systems, the packaging industry or a comparable environment:

- Height measurement
- Width measurement
- Contour measurement
- Orientation detection

|   |
|---|
|  <b>CAUTION</b>  |
| <p><b>Observe intended use!</b></p> <p>↳ Only operate the device in accordance with its intended use.</p> <p>The protection of personnel and the device cannot be guaranteed if the device is operated in a manner not complying with its intended use.</p> <p>Leuze electronic GmbH + Co. KG is not liable for damages caused by improper use.</p> <p>↳ Read the original operating instructions before commissioning the device.</p> <p>Knowledge of the original operating instructions is an element of proper use.</p> |

|  |
|--|
| <b>NOTICE</b>  |
| <p><b>Comply with conditions and regulations!</b></p> <p>↳ Observe the locally applicable legal regulations and the rules of the employer's liability insurance association.</p> |

### 2.2 Foreseeable misuse

Any use other than that defined under "Intended use" or which goes beyond that use is considered improper use.

In particular, use of the device is not permitted in the following cases:

- Circuits relevant to safety
- Operation for medical purposes

|  |
|--|
| <b>NOTICE</b>  |
| <p><b>Do not modify or otherwise interfere with the device!</b></p> <p>↳ Do not carry out modifications or otherwise interfere with the device.</p> <p>The device must not be tampered with and must not be changed in any way.</p> <p>The device must not be opened. There are no user-serviceable parts inside.</p> <p>Repairs must only be performed by Leuze electronic GmbH + Co. KG.</p> |

### 2.3 Competent persons

Connection, mounting, commissioning and adjustment of the device must only be carried out by competent persons.

Prerequisites for competent persons:

- They have a suitable technical education.
- They are familiar with the rules and regulations for occupational safety and safety at work.
- They are familiar with the original operating instructions of the device.
- They have been instructed by the responsible person on the mounting and operation of the device.

#### Certified electricians

Electrical work must be carried out by a certified electrician.

Due to their technical training, knowledge and experience as well as their familiarity with relevant standards and regulations, certified electricians are able to perform work on electrical systems and independently detect possible dangers.

In Germany, certified electricians must fulfill the requirements of accident-prevention regulations BGV A3 (e.g. electrician foreman). In other countries, there are respective regulations that must be observed.

### 2.4 Exemption of liability

Leuze electronic GmbH + Co. KG is not liable in the following cases:

- The device is not being used properly.
- Reasonably foreseeable misuse is not taken into account.
- Mounting and electrical connection are not properly performed.
- Changes (e.g., constructional) are made to the device.

### 2.5 Notices for the safe use of sensors in potentially explosive areas

These notices apply for devices with the following classification:

Table 2.1: Classification of the devices

| Device group | Device category | Equipment protection level | Zone      |
|--------------|-----------------|----------------------------|-----------|
| II           | 3G              | Gc                         | 2 (gas)   |
| II           | 3D              | Dc                         | 22 (dust) |

 **WARNING**

**Safe use of sensors in potentially explosive areas!**

↪ Check whether the device classification corresponds to the requirements of the application.  
 A safe operation is only possible if the devices are used properly and for their intended purpose.  
 The devices are not suited for the protection of persons and may not be used for emergency shutdown purposes.  
 Electrical devices may endanger humans and (where applicable) animal health, and may threaten the safety of goods if used incorrectly or under unfavorable conditions in potentially explosive areas.

↪ Observe the applicable national regulations (e.g., EN 60079-14) for the configuration and installation of explosion-proof systems.

#### Installation and Commissioning

- ↪ Only have the devices installed and commissioned by certified electricians.  
 The certified electricians must be knowledgeable of the regulations and the operation of explosion-proof equipment.
- ↪ Prevent unintended disconnection while under voltage.

Devices with connector must be equipped with a safeguard or a mechanical interlocking guard; see table 17.9.

Attach the warning sign "Do not disconnect under voltage" that is supplied with the device to the sensor or the mounting bracket so that it is clearly visible.

↵ Protect the connection cables and connectors from excessive pulling or pushing strain.

↵ Avoid electrostatic charging.

Integrate metallic parts (e.g., housing, mounting devices) in the potential equalization.

↵ Prevent dust deposits from forming on the devices.

### **Maintenance**

↵ Make no changes to explosion-proof devices.

Cyclical maintenance of the device is not necessary.

↵ Replace defective devices immediately.

↵ Only have repairs performed by the manufacturer.

↵ Clean the lens cover of the device from time to time; see chapter 14 "Care, maintenance and disposal".

### **Chemical resistance**

- The devices demonstrate good resistance against diluted (weak) acids and bases.
- Exposure to organic solvents is possible only under certain circumstances and only for short periods of time.
- Test the resistance to chemicals on a case-by-case basis.

### **Special conditions**

↵ Protect the devices from direct exposure to UV rays.

The devices must be installed in such a way that they are not directly exposed to any UV rays (sunlight).

↵ Avoid static charging on plastic surfaces.

### 3 Device description

#### 3.1 General information

The light curtains of the CML 700i series are designed as measuring and object-detecting, configurable, multi-sensor units. Depending on the configuration and model, the devices are suitable for a variety of tasks with various resolutions and can be integrated in different control environments.

The total system of the light curtain consists of a transmitter and a receiver, including the connection and interconnection cables.

- Transmitter and receiver are connected to one another via a synchronization cable.
- The integrated control panel with indicators and operational controls for configuring the total system is located on the receiver.
- The shared power supply is provided via connection X1 on the receiver.

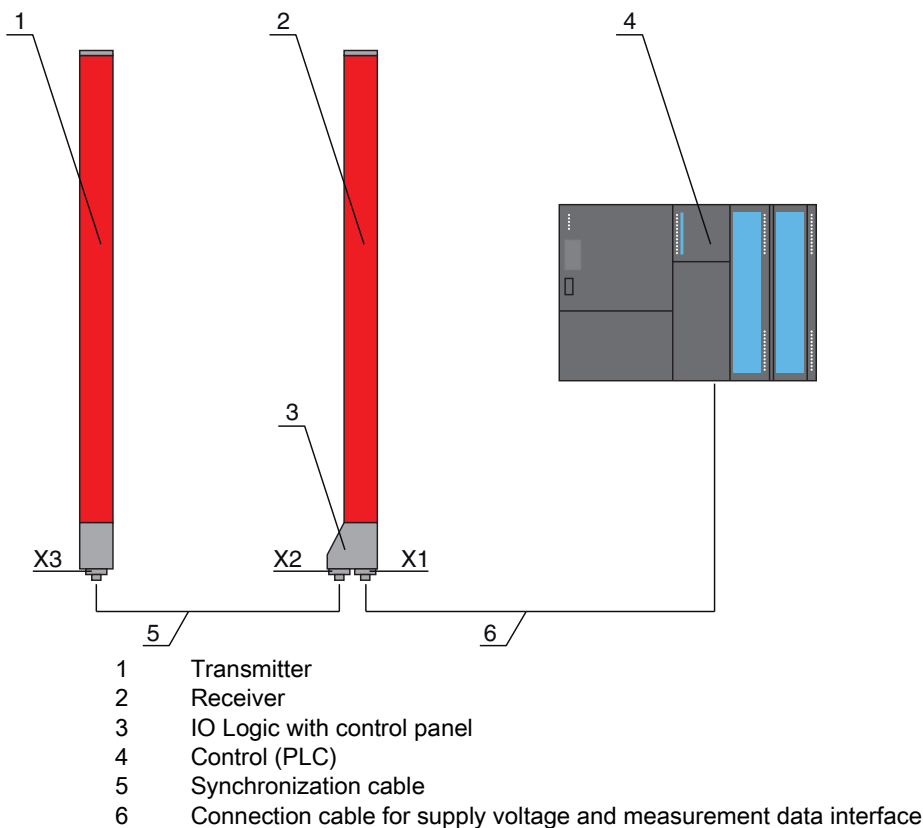

Figure 3.1: Total system in combination with a programmable logic control

#### 3.2 General performance characteristics

The most important performance characteristics of the CML 720i Ex series are:

- Operating range up to 6000 mm
- Measurement field length from 130 mm to 2950 mm
- Beam spacings of 5 mm\*, 10 mm, 20 mm, 40 mm\*  
 \*: Devices with beam spacing of 5 mm and 40 mm can only be ordered upon consultation with Leuze electronic.
- Response time 30 µs per beam
- Beam modes: parallel, diagonal, crossed-beam
- Single-beam evaluation (beam-stream)
- Evaluation functions: TIB, TNIB, LIB, LNIB, FIB, FNIB, status of beam areas 1 ... 32, status of the digital inputs/outputs
- Local control panel with display

- Interfaces to the machine control:
  - IO-Link and CANopen interfaces:  
2 digital inputs/outputs (configurable)
- Blanking of unnecessary beams
- Smoothing for interference suppression
- Cascading of multiple devices
- Block evaluation of beam areas
- Position / hole recognition with continuous web material
- Explosion protection
  - Zone 22 (dust)  
Devices with measurement field length from 130 mm to 2950 mm
  - Zone 2 (gas)  
Devices with measurement field length from 130 mm to 2550 mm

### 3.3 Connection system

The transmitter and receiver feature an M12 connector with the following number of pins:

| Device type | Designation on device | Plug/socket        |
|-------------|-----------------------|--------------------|
| Receiver    | X1                    | M12 plug (8-pin)   |
| Receiver    | X2                    | M12 socket (5-pin) |
| Transmitter | X3                    | M12 plug (5-pin)   |

### 3.4 Display elements

The display elements show the device status in operation and provide support during commissioning and error analysis.

Located on the receiver is a control panel with the following display elements:

- two LEDs
- one OLED display (Organic Light-Emitting Diode), two-line

Located on the transmitter is the following display element:

- one LED

#### 3.4.1 Operation indicators on the receiver control panel

Two function indicator LEDs are located on the receiver control panel.

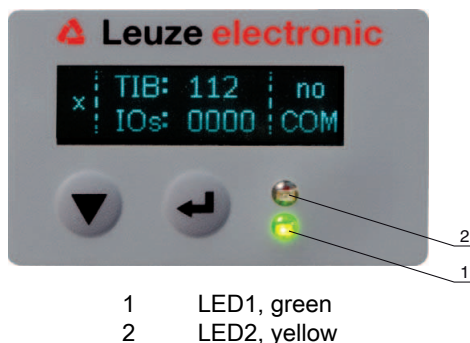

Figure 3.2: LED indicators on the receiver

Table 3.1: Meaning of the LEDs on the receiver

| LED | Color  | State                 | Description                                       |
|-----|--------|-----------------------|---|
| 1   | Green  | ON (continuous light) | Light curtain ready (normal mode)                 |
|     |        | Flashing              | see chapter 13.2                                  |
|     |        | OFF                   | Sensor not ready                                  |
| 2   | Yellow | ON (continuous light) | All active beams are free - with function reserve |
|     |        | Flashing              | see chapter 13.2                                  |
|     |        | OFF                   | At least one beam interrupted (object detected)   |

### 3.4.2 Display on the receiver control panel

Located on the receiver is an OLED display which serves as a function indicator.



Figure 3.3: OLED display on the receiver

The type of display on the OLED display is different for the following operating modes:

- Alignment mode
- Process mode

#### Display indicators in alignment mode

In alignment mode, the OLED display shows the received signal level of the first (FB) and last (LB) beam via two bar graph indicators.

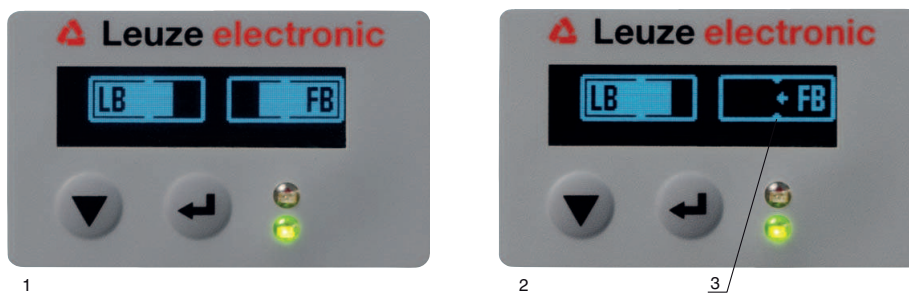

- 1 Evenly aligned light curtain
- 2 No reception signal from first beam (FB); good reception signal from last beam (LB)
- 3 Marker for the minimum signal level which is to be achieved

Figure 3.4: OLED display on the receiver in alignment mode

#### Display indicators in process mode

In process mode, the upper line shows the number of interrupted beams (TIB) and the lower line shows the logic state of the digital outputs.

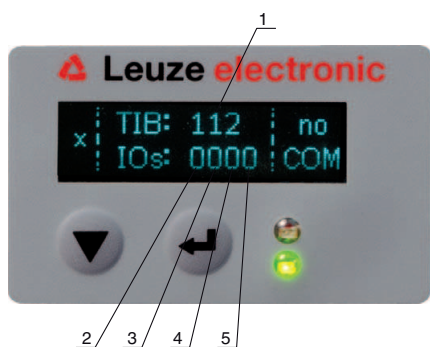

- 1 Number of interrupted beams
- 2 Logic state at pin 2 (0 = not active, 1 = active)
- 3 Logic state at pin 5 (0 = not active, 1 = active)
- 4 Logic state at pin 6 (0 = not active, 1 = active)
- 5 Logic state at pin 7 (0 = not active, 1 = active)

Figure 3.5: OLED display on the receiver in process mode



If the control panel is not used for several minutes, the display darkens and switches off. Press a function button to again make the display visible. Settings for visibility, display duration, etc. can be changed via the Display menu.

### 3.4.3 Operating indicators on the transmitter

Located on the transmitter is an LED which serves as a function indicator.

Table 3.2: Meaning of the LED on the transmitter

| LED | Color | State   | Description   |
|-----|-------|---|---|
| 1   | Green | ON<br>(continuous light or flashing in sync with the measurement) | Light curtain operates continuously with maximum measurement frequency                |
|     |       | OFF   | No communication with the receiver<br>Light curtain waits for external trigger signal |

### 3.5 Operating elements on the receiver control panel

Located on the receiver below the OLED display is a membrane keyboard with two function buttons for entering various functions.



Figure 3.6: Function buttons on the receiver



### 3.6 Menu structure of the receiver control panel

The following summary shows the structure of all menu items. In a given device model, only the actually available menu items are present for entering values or for selecting settings.

#### Menu level 0

**Level 0**

|               |
|---------------|
| Main Settings |
| Digital IOs   |
| Analog Output |
| Display       |
| Information   |
| Exit          |

#### Menu "Main Settings"

| Level 1             | Level 2          | Description                           |                   |                  |            |
|---------------------|------------------|---------------------------------------|-------------------|------------------|------------|
| Command             |                  | Teach                                 | Reset             | Factory Settings | Exit       |
| Operational setting | Filter Depth     | (enter value)<br>min = 1<br>max = 255 |                   |                  |            |
|                     | Beam mode        | Parallel                              | Diagonal          | Crossed-beam     |            |
|                     | Function reserve | High                                  | Medium            | Low              |            |
|                     | Blanking Teach   | Inactive<br>Active                    |                   |                  |            |
|                     | Power-Up Teach   | Inactive<br>Active                    |                   |                  |            |
|                     | Smoothing        | (enter value)<br>min = 1<br>max = 255 |                   |                  |            |
| IO-Link             | Bit rate         | COM3: 230.4 kbit/s                    | COM2: 38.4 kbit/s |                  |            |
|                     | PD Length        | 2 bytes                               | 8 bytes           | 32 bytes         |            |
|                     | Data Storage     | Deactivated                           | Activated         |                  |            |
| CANopen             | Node ID          | (enter value)<br>min = 1<br>max = 127 |                   |                  |            |
|                     | Bit rate         | 1000 kbit/s                           | 500 kbit/s        | 250 kbit/s       | 125 kbit/s |

#### Menu "Digital IOs"

| Level 1                                      | Level 2      | Description                            |              |          |          |             |
|--|--------------|--|--------------|----------|----------|-------------|
| IO Logic                                     |              | Positive PNP                           | Negative NPN |          |          |             |
| IO Pin 2<br>IO Pin 5<br>IO Pin 6<br>IO Pin 7 | IO Function  | Trigger In                             | Teach In     | Area Out | Warn Out | Trigger Out |
|  | Inversion    | Normal                                 | Inverted     |          |          |             |
|  | Teach height | Execute                                | Exit         |          |          |             |
|  | Area Logic   | AND                                    | OR           |          |          |             |
|  | Start Beam   | (enter value)<br>min = 1<br>max = 1774 |              |          |          |             |
|  | End Beam     | (enter value)<br>min = 1<br>max = 1774 |              |          |          |             |

### Menu "Display"

| Level 1             | Level 2 | Description   |
|---------------------|---------|---|
| Language            |         | English      German      French      Italian      Spanish |
| Mode                |         | Process mode      Alignment                               |
| Visibility          |         | Off      Dark      Normal      Bright      Dynamic        |
| Time Unit (s)       |         | (enter value)<br>min = 1<br>max = 240                     |
| Evaluation function |         | TIB      TNIB      FIB      FNIB      LIB      LNIB       |





### Menu "Information"









| Level 1           | Level 2 | Description                                |
|-------------------|---------|--|
| Product name      |         | CML 720i Ex                                |
| Product ID        |         | Receiver part no. (e.g., 50119835)         |
| Serial number     |         | Receiver serial number (e.g., 01436000288) |
| Tx.transmitter-ID |         | Transmitter part no. (e.g., 50119407)      |
| Tx.transmitter-SN |         | Transmitter serial no. (e.g., 01436000289) |
| FW version        |         | e.g., 01.61                                |
| HW version        |         | e.g., A001                                 |
| Kx version        |         | e.g., P01.30e                              |

## 3.7 Menu navigation on the receiver control panel

The ▼ and ← buttons have different functions depending on the operating situation. These functions are displayed at the left edge of the display above the icons.



### 3.7.1 Meaning of the display icons

| Icon  | Position    | Function  |
|---|-------------|---|
|  | First line  | Symbolizes that you can select the next parameter within a menu level by pressing the ▼ button.   |
|  | First line  | Symbolizes that you have reached the lowest menu level (not highlighted).   |
|  | Second line | Symbolizes the respective, next menu level that you have not yet selected (not highlighted).  |
|  | Second line | Press the ← button to exit the menu level or the menu.  |
|  | Second line | Symbolizes the input mode. The selected (highlighted) option field can be a fixed selection parameter or a multi-digit input field. With a multi-digit input field, you can increase the active digit by one with the ▼ button and use the ← button to switch from one digit to the next. |



| Icon  | Position    | Function  |
|---|-------------|---|
|  | Second line | Symbolizes the confirmation of a selection. This icon appears when you complete an option field with the  button.  |
|  | Second line | Symbolizes the rejection of a selection. This icon is accessed from the previous icon (check mark) by pressing the  button. This mode allows you to reject the current value or option parameter by pressing the  button.   |
|  | Second line | Symbolizes the return to the selection. This icon is accessed from the previous icon (cross) by pressing the  button. This mode allows you to reset the current value or option parameter for the purpose of entering a new value or selecting an option parameter by pressing the  button. |



### 3.7.2 Level display

The display of bars between icons and text that span both lines indicates the open menu levels. The example shows a configuration in the menu level 2:



|  |                   |
|--|-------------------|
|   | <b>Start Beam</b> |
|  | End Beam          |

### 3.7.3 Menu navigation



|   |                      |
|---|----------------------|
|  | <b>Main Settings</b> |
|  | Digital IOs          |

-  Selects the next menu item (“Digital IOs”); the other menu items follow if pressed again.
-  Selects the highlighted submenu (“Main Settings”).

### 3.7.4 Editing value parameters



|   |                   |
|---|-------------------|
|  | <b>Start Beam</b> |
|  | End Beam          |



-  Selects the “Start Beam” menu item with the bright background.

|   |  |  |            |
|---|--|--|------------|
|  |  |  | Start Beam |
|  |  |  | 0001       |



- ▼ Changes the value of the first digit (0).
- ↵ Selects additional numbers for configuring values.

After entering the last number, the total value can be saved, rejected or reset.

|   |  |  |            |
|---|--|--|------------|
|  |  |  | Start Beam |
|  |  |  | 0010       |



- ↵ Saves the new value (0010).
- ▼ Changes the action mode; first  and then  appears on the second line.

If the selected option is not saved in the window above, but rather the  action mode is selected with the ▼ button, this means:

|   |  |  |            |
|---|--|--|------------|
|  |  |  | Start Beam |
|  |  |  | 0010       |



- ↵ Rejects the current input value. The display returns to the higher-order menu level: Start Beam/End Beam

If the  action mode is selected with the ▼ button, this means:



|   |  |  |            |
|---|--|--|------------|
|  |  |  | Start Beam |
|  |  |  | 0010       |

- ↵ Resets the current input value (0001) and allows the entry of new values.

### 3.7.5 Editing selection parameters

|   |          |
|---|----------|
|  | IO Logic |
|  | IO Pin 2 |



↶ Selects the “IO Logic” menu item with the bright background.



|   |                     |
|---|---------------------|
|  | IO Logic            |
|  | <b>Positive PNP</b> |

▼ With each actuation, displays the next option on this menu level, i.e., the display switches between:

- Negative NPN
- Positive PNP

↶ Selects the “Positive PNP” menu item with the bright background.

|   |                     |
|---|---------------------|
|  | IO Logic            |
|  | <b>Positive PNP</b> |

▼ Changes the action mode;  appears; subsequent actuation displays  or  again.

↶ Saves the selected option “Positive PNP”.

## 4 Functions

This chapter describes the functions of the light curtain for adaptation to different applications and operating conditions.

### 4.1 Beam modes

#### 4.1.1 Parallel

In “parallel”-beam mode (parallel-beam scanning), the light beam of each transmitter LED is detected by the directly opposing receiver LED.

Figure 4.1: Beam path in “parallel” beam mode

#### 4.1.2 Diagonal

In “diagonal” beam mode, the light beam of each transmitter diode is received in succession both by the directly opposing receiver diode as well as by the next receive