

IS 218

Inductive switches

en 03-2015/05 50110214



**M18**  
8 mm  
20 mm



10 - 30 V  
DC  
**non-embedded**  
2 kHz

- Slim and short cylindrical metal housing M8
- Chromium-plated brass housing
- Built-in short circuit protection, inductive protection and polarity reversal protection
- LED for switching state visible from 360°

Dimensioned drawing

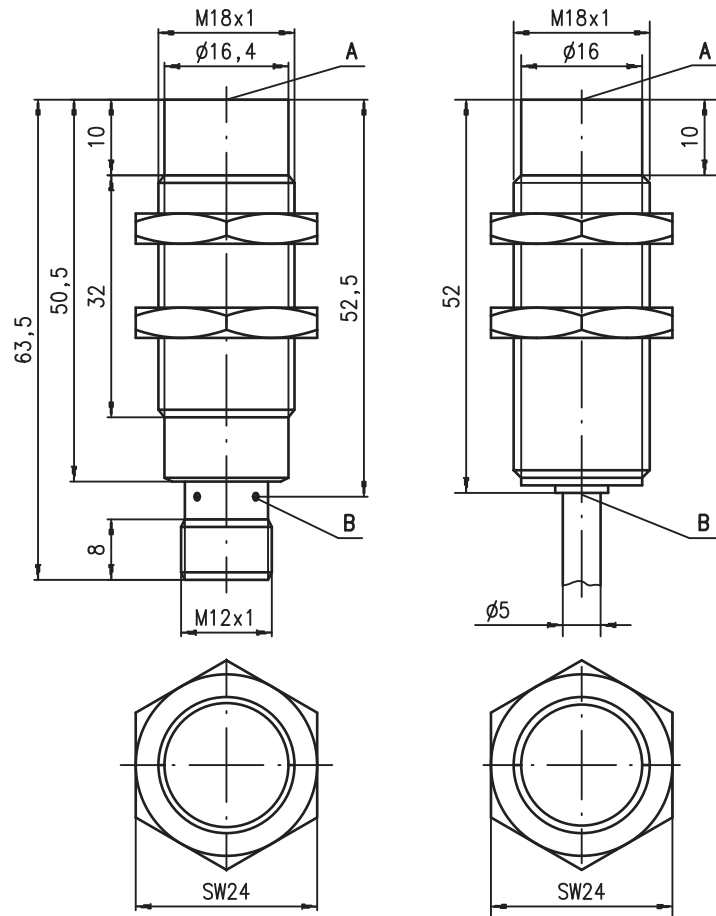

**Tightening torque of the fastening nuts**  
IS 218...8N0... < 20Nm !  
IS 218...20N... < 25Nm !

- A Active surface
- B Yellow indicator diode

Electrical connection

Cable

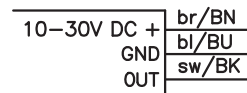

M12 connector

...NO... (normally open)

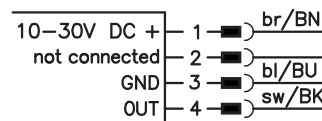

...NC... (normally closed)

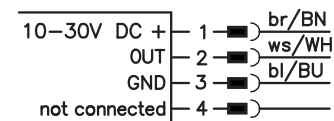

...NO...-S12 (normally open):  
...NC...-S12 (normally closed):

3-pin or 4-pin M12 connection cables can be used.  
only 4-pin M12 connection cables can be used.

We reserve the right to make changes • DS\_IS218N\_en\_50110214.fm



Accessories:

(available separately)

- M12 connectors (KD ...)
- Ready-made cables (K-D ...)
- Mounting clamp (MC 018...)

## Specifications

### General specifications

Type of installation  
 Typ. operating range limit  $S_n$   
 Operating range  $S_a$

### IS 218...-8N0...

non-embedded installation  
 8.0mm  
 0 ... 6.5mm

### IS 218...-20N...

20.0mm  
 0 ... 16.2mm

### Electrical data

Operating voltage  $U_B$  <sup>1)</sup>  
 Residual ripple  $\sigma$   
 Output current  $I_L$   
 Open-circuit current  $I_0$   
 Residual current  $I_r$   
 Switching output/function

10 ... 30VDC  
 $\leq 20\%$  of  $U_B$   
 $\leq 200$ mA  
 $\leq 10$ mA  
 $\leq 100\mu$ A  
 .../4NO... PNP transistor, make-contact (NO)  
 .../4NC... PNP transistor, break-contact (NC)  
 .../2NO... NPN transistor, make-contact (NO)  
 .../2NC... NPN transistor, break-contact (NC)

Voltage drop  $U_d$   
 Hysteresis H of  $S_r$   
 Temperature drift of  $S_r$   
 Repeatability

$\leq 2$ V  
 $\leq 10\%$   
 $\leq 10\%$  <sup>2)</sup>  
 $\leq 5\%$  <sup>3)</sup>

### Timing

Switching frequency f  
 Delay before start-up

2kHz  
 $\leq 40$ ms  
 200Hz  
 $\leq 100$ ms

### Indicators

Yellow LED (visible from 360°)

switching state

### Mechanical data

Housing  
 Standard surface plate  
 Active surface  
 Weight (M12 plug/cable)  
 Connection type

chromium-plated brass  
 24 x 24mm<sup>2</sup>, Fe360  
 PBTP  
 approx. 50g/approx. 120g  
 M12 connector 4-pin or  
 cable: 2m, PVC, 3 x 0.34mm<sup>2</sup>,  $\varnothing$  5.0mm  
 60 x 60mm<sup>2</sup>, Fe360

### Environmental data

Ambient temperature  
 Protection class  
 Protective circuit <sup>4)</sup>  
 Standards applied  
 Electromagnetic compatibility

-25°C ... +70°C  
 IP 67  
 1, 2, 3  
 IEC/EN 60947-5-2  
 IEC 60255-5  
 IEC 61000-4-2  
 IEC 61000-4-3  
 IEC 61000-4-4  
 1kV  
 Level 3 air 8kV (ESD)  
 Level 3 10V/m (RFI)  
 Level 3 2kV (Burst)

- 1) Observe the safety regulations and installation instructions regarding power supply and wiring; for UL applications: only for use in "Class 2" circuits acc. to NEC
- 2) Over the entire operating temperature range
- 3) For  $U_B = 20 \dots 30$ VDC, ambient temperature  $T_a = 23^\circ\text{C} \pm 5^\circ\text{C}$
- 4) 1=polarity reversal protection, 2=short circuit protection, 3=inductive protection for all outputs

## Remarks

### Operate in accordance with intended use!

- ⚠ This product is not a safety sensor and is not intended as personnel protection.
- ⚠ The product may only be put into operation by competent persons.
- ⚠ Only use the product in accordance with the intended use.

## Tables

### Reduction factors:

	for $S_n = 8.0$ mm		for $S_n = 20.0$ mm	
Steel Fe360	1		Steel Fe360	1
Copper	0.40		Copper	0.35
Aluminum	0.50		Aluminum	0.40
Brass	0.50		Brass	0.45
Stainless steel	0.80		Stainless steel	0.66

## Mounting

### Non-embedded installation:

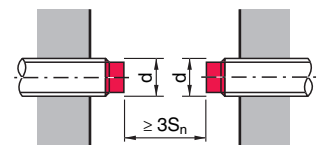
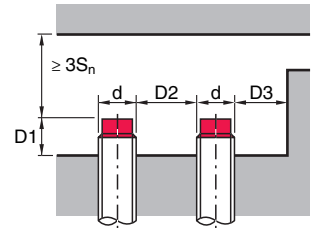

Ferromagnetic and non-ferromagnetic materials				
$S_n$ [mm]	D1 [mm]	D2 [mm]	D3 [mm]	
8.0	10.0	32.0	11.0	
20.0	20.0	50.0	21.0	

## Diagrams

### Models with $S_n = 8.0$ mm

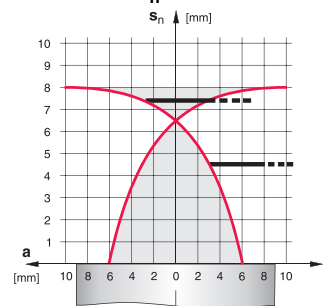

— ON Inductive switch  
 - - - Standard surface plate

### Models with $S_n = 20.0$ mm

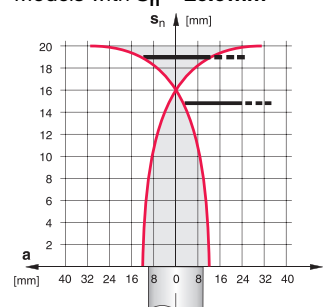

— ON Inductive switch  
 - - - Standard surface plate

## Type key

I	S	2	1	8	M	M	/	4	N	0	-	8	N	0	-	S	1	2
---	---	---	---	---	---	---	---	---	---	---	---	---	---	---	---	---	---	---

**Operating principle / construction**
**IS** Inductive switch / Standard

**Series**
**218** series with M18 x 1 external thread

**Housing / thread**
**MM** metal housing (active surface: plastic) / metric thread

**Output function**
**4NO** PNP transistor, make-contact (NO)

**4NC** PNP transistor, break-contact (NC)

**2NO** NPN transistor, make-contact (NO)

**2NC** NPN transistor, break-contact (NC)

**Measurement range / type of installation**
**8NO** typ. scan range limit 8.0mm / non-embedded installation

**20N** typ. scan range limit 20.0mm / non-embedded installation

**Electrical connection**
**N/A** Cable, PVC, standard length 2000mm

**S12** M12 connector, 4-pin, axial

**200-S12** cable, PVC, length 200mm with M12 connector, 4-pin, axial

## Order guide

The sensors listed here are preferred types; current information at [www.leuze.com](http://www.leuze.com).

	Designation	Part No.
<b>S<sub>n</sub> = 8mm</b>	IS 218 MM/4NO-8NO	50109696
	IS 218 MM/4NO-8NO-S12	50109697
	IS 218 MM/4NC-8NO	50129360
	IS 218 MM/4NC-8NO-S12	50129361
	IS 218 MM/2NO-8NO	50109698
	IS 218 MM/2NO-8NO-S12	50109699
	IS 218 MM/2NC-8NO	50129362
	IS 218 MM/2NC-8NO-S12	50129363
<b>S<sub>n</sub> = 20mm</b>	IS 218 MM/4NO-20N	50109709
	IS 218 MM/4NC-20N	50129365
	IS 218 MM/2NO-20N	50111953

