

Technical data sheet · Network cables PROFINET

Actuator sensor interface



Identification	Type	STG4-RJ45/STG4-M12/PN CAT5 PVC 5,0M
	Part-No.	192014.0500

Description	Male RJ45 straight to female M 12 straight with PVC cable, Cat 5 self-locking screwed connection
--------------------	---

Technical data	
Number of conductors/cross-section	(2×2×AWG22/7)
Form male 1	RJ45
Form male 2	M 12
Pole number	4
Category	Cat 5
Number of conductors	4
Outer Ø	6.5 mm
Cable length	5 m
Rated voltage U_N	DC 24 V
Rated current	1.5 A
Test voltage	1000 V
Insulation resistance	>1000 MΩ × km
Contact resistance	<20 mΩ
Protection class	IP20
Coding	D

28.04.2017 – Subject to technical modification

Part-No. 192014.0500

USA: LUTZE INC.

13330 South Ridge Drive • Charlotte, NC 28273, USA
Tel. +1 (704) 504-0222 • Fax +1 (704) 504-0223
www.lutze.com • info@lutze.com

United Kingdom: LÜTZE Ltd.

Unit 3, Sandy Hill Park
Sandy Way, Amington • GB-Tamworth, Staffs B77 4DU
Tel. +44 (0)1827 31333-0 • Fax +44 (0)1827 31333-2
www.lutze.com • sales.gb@lutze.co.uk



SYSTEMATIC TECHNOLOGY

Technical data sheet · Network cables PROFINET

Shielding	360°
Temperature range connector	-25 °C ... 85 °C
Temperature range fixed	-25 °C ... +80 °C
Temperature range moving	+5 °C ... +70 °C
Minimum bending radius fixed	6×D
Minimum bending radius moving	12×D
Mounting	Breakaway torque 0.4 Nm

Construction

Number of conductors/cross-section	(2×2×AWG22/7)
Number of conductors	4
Conductor color	various
Conductor insulation	TPE-O
Jacket material	PVC
Jacket color	green RAL 6018

General

Housing material	TPU PA
Colour of the housing	black
Contact material	CuSn, gold-plated
Thread material	Zinc die-casting, nickel-plated
Mounting	Breakaway torque 0.4 Nm
Weight	0.34 kg/piece
PU	1 Quantity

Dimensions



PIN assignment

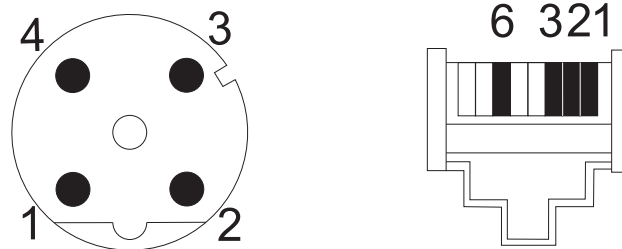

28.04.2017 – Subject to technical modification

Part-No. 192014.0500

USA: LUTZE INC.

13330 South Ridge Drive • Charlotte, NC 28273, USA

Tel. +1 (704) 504-0222 • Fax +1 (704) 504-0223

www.lutze.com • info@lutze.com

United Kingdom: LÜTZE Ltd.

Unit 3, Sandy Hill Park

Sandy Way, Amington • GB-Tamworth, Staffs B77 4DU

Tel. +44 (0)1827 31333-0 • Fax +44 (0)1827 31333-2

www.lutze.com • sales.gb@lutze.co.uk



SYSTEMATIC TECHNOLOGY

Technical data sheet · Network cables PROFINET

Circuit diagram

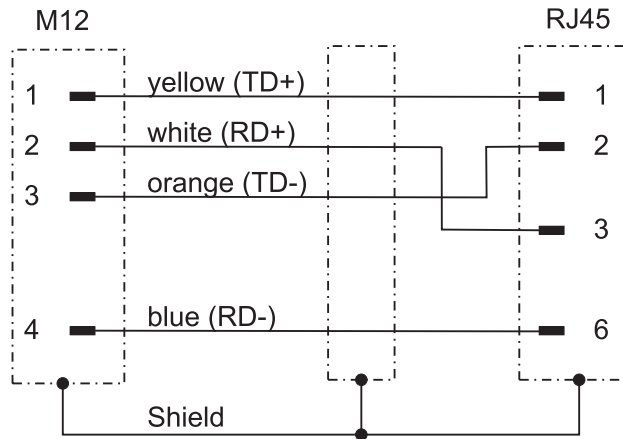

28.04.2017 – Subject to technical modification

Part-No. 192014.0500

USA: LUTZE INC.

13330 South Ridge Drive • Charlotte, NC 28273, USA

Tel. +1 (704) 504-0222 • Fax +1 (704) 504-0223

www.lutze.com • info@lutze.com

United Kingdom: LÜTZE Ltd.

Unit 3, Sandy Hill Park

Sandy Way, Amington • GB-Tamworth, Staffs B77 4DU

Tel. +44 (0)1827 31333-0 • Fax +44 (0)1827 31333-2

www.lutze.com • sales.gb@lutze.co.uk



SYSTEMATIC TECHNOLOGY