

## Technical data sheet · Actuator sensor interface

M12 / M12 – cables



<b>Identification</b>	Type	STG8-M12/KUG8-M12 5,0M PUR
	Part-No.	420050

<b>Description</b>	Male M12 straight to female M12 straight with PUR cable self-locking screwed connection c-track compatible, halogen free
--------------------	--

<b>Technical data</b>	
Rated voltage $U_N$	AC/DC 24 V
Rated voltage max.	30 V
Rated current	2 A
Pole number	8
Cable length	5.0 m
Coding	A

<b>General</b>	
Form male 1	M 12 Male straight
Form male 2	M 12 Female straight
Nominal insulation voltage	36 V

29.04.2017 – Subject to technical modification

Part-No. 420050

USA: LUTZE INC.

13330 South Ridge Drive · Charlotte, NC 28273, USA  
Tel. +1 (704) 504-0222 · Fax +1 (704) 504-0223  
www.lutze.com · info@lutze.com

United Kingdom: LÜTZE Ltd.

Unit 3, Sandy Hill Park  
Sandy Way, Amington · GB-Tamworth, Staffs B77 4DU  
Tel. +44 (0)1827 31333-0 · Fax +44 (0)1827 31333-2  
www.lutze.com · sales.gb@lutze.co.uk



SYSTEMATIC TECHNOLOGY

## Technical data sheet - Actuator sensor interface

---

Test voltage	1500 V
Degree of pollution	3
Insulation resistance	> 1000 MΩ × km
Contact resistance	< 5 mΩ
Flamability according to UL 94	V0
Protection class	IP65/67/68
Housing material	TPU
Colour of the housing	black
Contact material	CuSn, gold-plated
Thread material	Zinc die-casting, nickel-plated
Material sealing ring	NBR
Mounting	Breakaway torque 0.4 Nm Breakaway torque 0.4 Nm
Number of conductors/cross-section	8 × 0.25 mm <sup>2</sup> (32 × 0.1)
Number of conductors	8
Jacket material	PUR
Jacket color	black
Conductor insulation	PP
Outer Ø	5.9 mm
Bending radius	10 × D
Minimum bending radius moving	10×D
Storage temperature range	-30 °C ... +90 °C
Temperature range connector	-25 °C ... +90 °C
Temperature range fixed	-40 °C ... +80 °C
Temperature range moving	-25 °C ... +80 °C
Weight	0.300 kg/piece
Approvals	cULus
PU	1 Quantity

---

### C-track chain properties

	Type B
Conduction properties (TYPE A+B+C)	PUR halogen free for extreme demands <ul style="list-style-type: none"><li>• Very good chemical stability</li><li>• Very resistant to oils and lubricants</li><li>• Very high abrasion resistance</li><li>• Halogen free</li><li>• Silicone free, free of paint wetting impairment substances</li><li>• Resistant to microbes and hydrolysis</li><li>• Good UV stability</li></ul>

29.04.2017 – Subject to technical modification

Part-No. 420050

USA: LUTZE INC.

13330 South Ridge Drive • Charlotte, NC 28273, USA

Tel. +1 (704) 504-0222 • Fax +1 (704) 504-0223

www.lutze.com • info@lutze.com

United Kingdom: LÜTZE Ltd.

Unit 3, Sandy Hill Park

Sandy Way, Amington • GB-Tamworth, Staffs B77 4DU

Tel. +44 (0)1827 31333-0 • Fax +44 (0)1827 31333-2

www.lutze.com • sales.gb@lutze.co.uk



SYSTEMATIC TECHNOLOGY

# Technical data sheet · Actuator sensor interface

## Dimensions

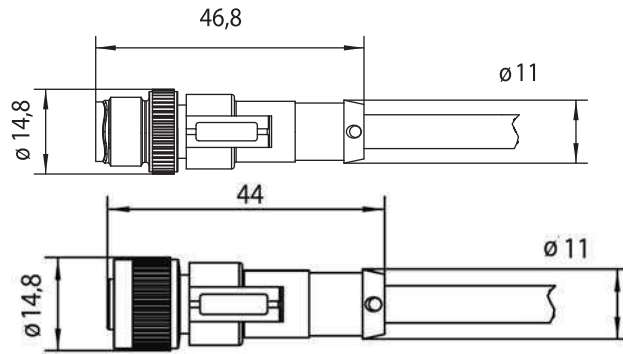

## PIN assignment

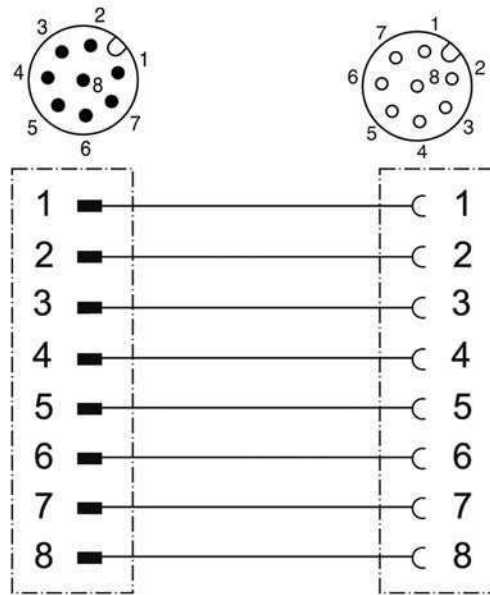

29.04.2017 – Subject to technical modification

Part-No. 420050

USA: LUTZE INC.

13330 South Ridge Drive · Charlotte, NC 28273, USA

Tel. +1 (704) 504-0222 · Fax +1 (704) 504-0223

www.lutze.com · info@lutze.com

United Kingdom: LÜTZE Ltd.

Unit 3, Sandy Hill Park

Sandy Way, Amington · GB-Tamworth, Staffs B77 4DU

Tel. +44 (0)1827 31333-0 · Fax +44 (0)1827 31333-2

www.lutze.com · sales.gb@lutze.co.uk



SYSTEMATIC TECHNOLOGY

**Symbols**



---

<b>Accessories</b>	<b>Part No.</b>	<b>Type</b>	<b>PU</b>
Torque setting tool M 12	490091	DM-SET M12	1

29.04.2017 – Subject to technical modification

Part-No. 420050

USA: LUTZE INC.

13330 South Ridge Drive • Charlotte, NC 28273, USA  
Tel. +1 (704) 504-0222 • Fax +1 (704) 504-0223  
www.lutze.com • info@lutze.com

United Kingdom: LÜTZE Ltd.

Unit 3, Sandy Hill Park  
Sandy Way, Amington • GB-Tamworth, Staffs B77 4DU  
Tel. +44 (0)1827 31333-0 • Fax +44 (0)1827 31333-2  
www.lutze.com • sales.gb@lutze.co.uk



SYSTEMATIC TECHNOLOGY