



Identification	Type	STG3-M12/KUW3-M8 LED A 1,0M PUR
	Part-No.	426010

Technical data

Nominal voltage	DC 24 V
Nominal voltage range	DC 10 – 30V
Rated current	3 A
Number of terminations	3
Cable length	1.0 m
Status Indication	Operating voltage: LED green, I/O: LED yellow
Current Consumption per LED	<10 mA / LED
Coding	A (M12)

General

Form	M12 × 1, male straight / M8 × 1, female angled with LEDs
Rated insulation voltage (EN 50178)	32 V
Pollution degree	3
Insulation resistance	>10 ⁹ Ω
Contact resistance	<5 mΩ
Class of flammability according to UL 94	V0
Protection class	IP 67, in screwed condition
Housing material	TPU black
Contact material	CuSn, gold plated nickel

03.10.2009 – Subject to technical modification

Part-No. 426010

USA: LUTZE INC.

13330 South Ridge Drive • Charlotte, NC 28273, USA
 Tel. +1 (704) 504-0222 • Fax +1 (704) 504-0223
 www.lutze.com • info@lutze.com

United Kingdom: LÜTZE Ltd.

Unit 3, Sandy Hill Park
 Sandy Way, Amington • GB-Tamworth, Staffs B77 4DU
 Tel. +44 (0)1827 31333-0 • Fax +44 (0)1827 31333-2
 www.lutze.com • sales.gb@lutze.co.uk



Systematic Technology

Technical data sheet • Actuator sensor interface

Thread material	CuSn nickel plated
Gasket	NBR
Cable construction	3 × 0.25 mm ² (32 × 0.1)
Cable jacket	PUR, RAL 9001 black
Conductor insulation	PVC coloured
Cable diameter	4.4 mm
Bending radius	15 x cable diameter
Storage temperature range	-30 °C–90 °C
Temperature range connector	-25 °C – 90 °C
Temperature range cable fixed	-25 °C–80 °C
Temperature range cable moving	-5 °C–80 °C
Weight (kg/piece)	0.040
Approvals	cULus
PU	10

Dimensions

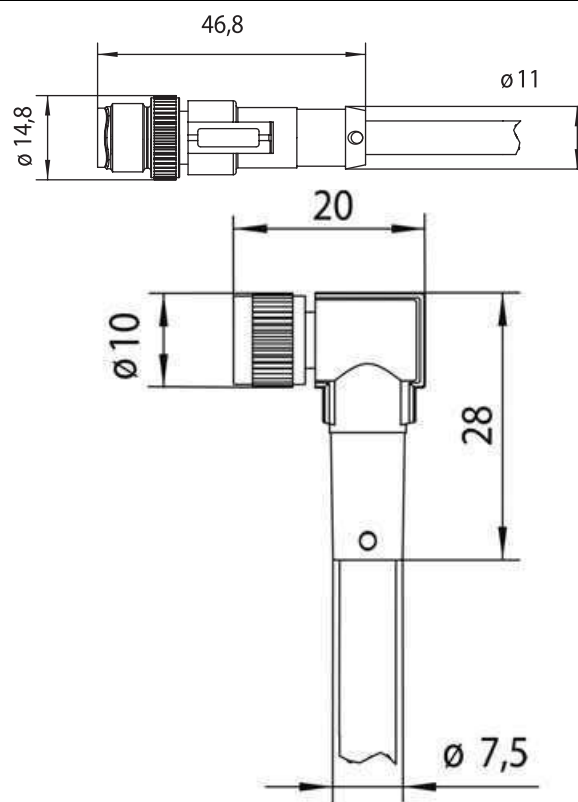

03.10.2009 – Subject to technical modification

Part-No. 426010

USA: LUTZE INC.

13330 South Ridge Drive • Charlotte, NC 28273, USA
Tel. +1 (704) 504-0222 • Fax +1 (704) 504-0223
www.lutze.com • info@lutze.com

United Kingdom: LÜTZE Ltd.

Unit 3, Sandy Hill Park
Sandy Way, Amington • GB-Tamworth, Staffs B77 4DU
Tel. +44 (0)1827 31333-0 • Fax +44 (0)1827 31333-2
www.lutze.com • sales.gb@lutze.co.uk

Technical data sheet • Actuator sensor interface

PIN assignment

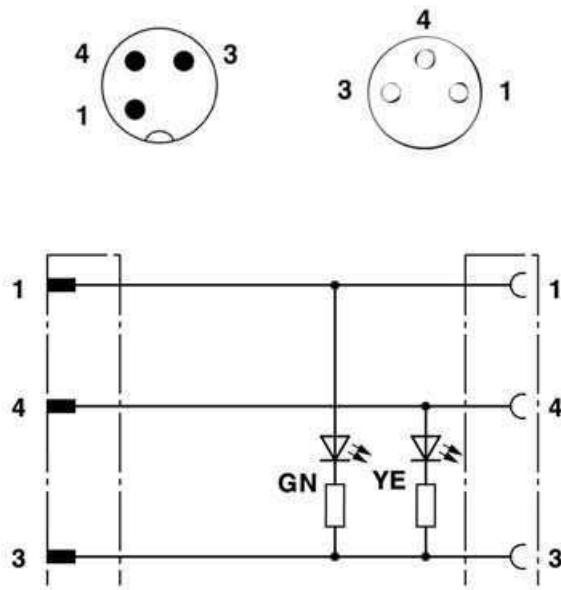

Logo



03.10.2009 – Subject to technical modification

Part-No. 426010

USA: LUTZE INC.

13330 South Ridge Drive • Charlotte, NC 28273, USA
Tel. +1 (704) 504-0222 • Fax +1 (704) 504-0223
www.lutze.com • info@lutze.com

United Kingdom: LÜTZE Ltd.

Unit 3, Sandy Hill Park
Sandy Way, Amington • GB-Tamworth, Staffs B77 4DU
Tel. +44 (0)1827 31333-0 • Fax +44 (0)1827 31333-2
www.lutze.com • sales.gb@lutze.co.uk