

Technical data sheet - Actuator sensor interface



Connection cables M 12 with solenoid plug A,
PUR cable

Identification	Type	STG3-M12/LZ-A 0,6M PUR
	Part-No.	435006
Description	Male M12 straight to valve connector form A with protection device and LED status indication c-track compatible, halogen free	
Technical data		
Rated voltage U_N	AC/DC 24 V	
Rated voltage min.	DC 10 V	
Rated voltage max.	28 V	
Rated current	4 A	
Rated frequency	50 – 60 Hz	
Protection device	Z-diode + LED	
Pole number	3	
Cable length	0.6 m	
Status indication	I/O: LED yellow	
Current Consumption	10 mA	
Cut-off peak	≤ 52 V	
Holding Capacity	100 VA	
Coding	A	

29.04.2017 – Subject to technical modification

Part-No. 435006

USA: LUTZE INC.

13330 South Ridge Drive • Charlotte, NC 28273, USA
Tel. +1 (704) 504-0222 • Fax +1 (704) 504-0223
www.lutze.com • info@lutze.com

United Kingdom: LÜTZE Ltd.

Unit 3, Sandy Hill Park
Sandy Way, Amington • GB-Tamworth, Staffs B77 4DU
Tel. +44 (0)1827 31333-0 • Fax +44 (0)1827 31333-2
www.lutze.com • sales.gb@lutze.co.uk



SYSTEMATIC TECHNOLOGY

Technical data sheet - Actuator sensor interface

General

Form male 1	M 12 Male straight
Form male 2	Valve connector Bauf. A
Nominal insulation voltage	32 V
Degree of pollution	3
Insulation resistance	> 100 M Ω × km
Contact resistance	< 5 m Ω
Flamability according to UL 94	V0
Protection class	IP65/67
Housing material	TPU
Colour of the housing	black / transparent
Contact material	CuSn, gold-plated
Thread material	Zinc die-casting, nickel-plated
Mounting	Breakaway torque 0.4 Nm
Number of conductors/cross-section	3 × 0.5 mm ²
Number of conductors	3
Jacket material	PUR
Jacket color	black
Conductor insulation	PP
Outer \varnothing	4.5 mm
Bending radius	10 × D
Minimum bending radius moving	10×D
Storage temperature range	-30 °C ... +90 °C
Temperature range connector	-20 °C ... +85 °C
Temperature range fixed	-40 °C ... +80 °C
Temperature range moving	-20 °C ... +70 °C
Weight	0.053 kg/piece
Standards	EN 175301-803
PU	1 Quantity

C-track chain properties

	Type B
Conduction properties (TYPE A+B+C)	PUR halogen free for extreme demands <ul style="list-style-type: none">• Very good chemical stability• Very resistant to oils and lubricants• Very high abrasion resistance• Halogen free• Silicone free, free of paint wetting impairment substances• Resistant to microbes and hydrolysis• Good UV stability

29.04.2017 – Subject to technical modification

Part-No. 435006

USA: LUTZE INC.

13330 South Ridge Drive • Charlotte, NC 28273, USA

Tel. +1 (704) 504-0222 • Fax +1 (704) 504-0223

www.lutze.com • info@lutze.com

United Kingdom: LÜTZE Ltd.

Unit 3, Sandy Hill Park

Sandy Way, Amington • GB-Tamworth, Staffs B77 4DU

Tel. +44 (0)1827 31333-0 • Fax +44 (0)1827 31333-2

www.lutze.com • sales.gb@lutze.co.uk



SYSTEMATIC TECHNOLOGY

Technical data sheet · Actuator sensor interface

Comments

Silicone free, Free from paint wetting impairment substances, resistant to microbes and hydrolysis. Very good resistance to acids, alkalines and solvents. The material resistance is based on the application for use with aggressive media.

Dimensions

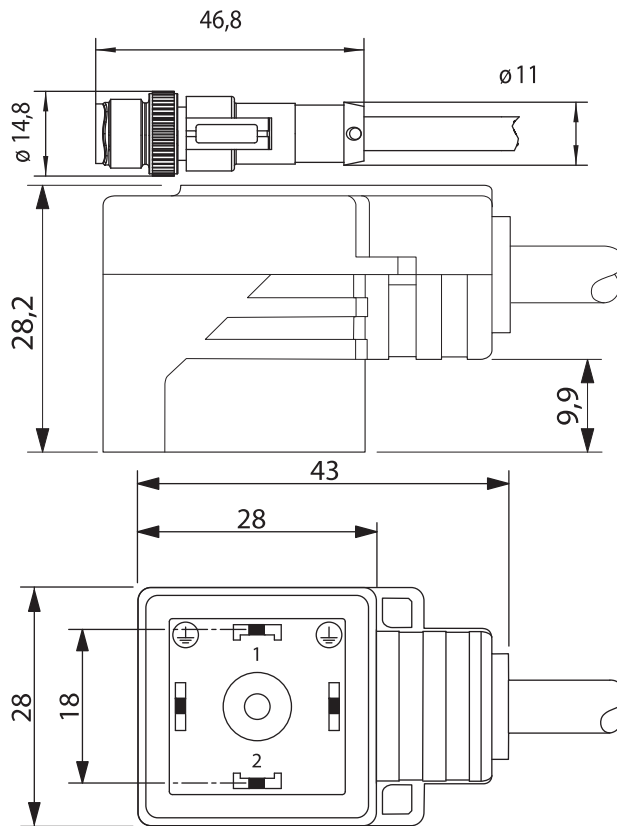

PIN assignment

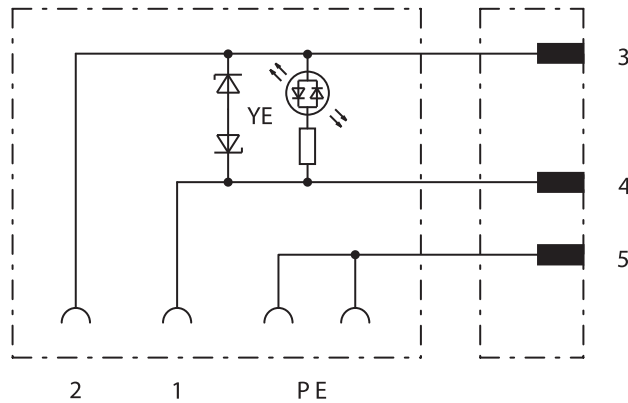

29.04.2017 – Subject to technical modification

Part-No. 435006

USA: LUTZE INC.

13330 South Ridge Drive · Charlotte, NC 28273, USA

Tel. +1 (704) 504-0222 · Fax +1 (704) 504-0223

www.lutze.com · info@lutze.com

United Kingdom: LÜTZE Ltd.

Unit 3, Sandy Hill Park

Sandy Way, Amington · GB-Tamworth, Staffs B77 4DU

Tel. +44 (0)1827 31333-0 · Fax +44 (0)1827 31333-2

www.lutze.com · sales.gb@lutze.co.uk



SYSTEMATIC TECHNOLOGY

Technical data sheet - Actuator sensor interface

Pin layout

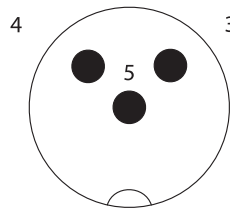

Symbols



Accessories

Torque setting tool M 12

Part No.

490091

Type

DM-SET M12

PU

1

29.04.2017 – Subject to technical modification

Part-No. 435006

USA: LUTZE INC.

13330 South Ridge Drive • Charlotte, NC 28273, USA
Tel. +1 (704) 504-0222 • Fax +1 (704) 504-0223
www.lutze.com • info@lutze.com

United Kingdom: LÜTZE Ltd.

Unit 3, Sandy Hill Park
Sandy Way, Amington • GB-Tamworth, Staffs B77 4DU
Tel. +44 (0)1827 31333-0 • Fax +44 (0)1827 31333-2
www.lutze.com • sales.gb@lutze.co.uk