



Identification	Type	KUW5-M12 2M PUR
	Part-No.	443020

Description	Female M12 angled with PUR cable, open end self-locking screwed connection c-track compatible, halogen free
--------------------	---

Technical data	
Rated voltage U_N	AC/DC 24 V
Rated voltage max.	60 V
Rated current	4 A
Pole number	5
Cable length	2.0 m
Coding	A

General	
Form male 1	M 12 Female angle connector
Form male 2	Line end open
Nominal insulation voltage	63 V
Test voltage	1500 V
Degree of pollution	3

29.04.2017 – Subject to technical modification

Part-No. 443020

USA: LUTZE INC.

13330 South Ridge Drive • Charlotte, NC 28273, USA
Tel. +1 (704) 504-0222 • Fax +1 (704) 504-0223
www.lutze.com • info@lutze.com

United Kingdom: LÜTZE Ltd.

Unit 3, Sandy Hill Park
Sandy Way, Amington • GB-Tamworth, Staffs B77 4DU
Tel. +44 (0)1827 31333-0 • Fax +44 (0)1827 31333-2
www.lutze.com • sales.gb@lutze.co.uk



Technical data sheet - Actuator sensor interface

Insulation resistance	> 1000 MΩ × km
Contact resistance	< 5 mΩ
Flamability according to UL 94	V0
Protection class	IP65/67/68
Housing material	TPU
Colour of the housing	black
Contact material	CuSn, gold-plated
Thread material	Zinc die-casting, nickel-plated
Material sealing ring	NBR
Mounting	Breakaway torque 0.4 Nm
Number of conductors/cross-section	5 × 0.34 mm ² (42 × 0.1)
Number of conductors	5
Conductor color	various
Jacket material	PUR
Jacket color	black
Conductor insulation	PP
Outer Ø	5.0 mm
Bending radius	10 × D
Minimum bending radius moving	10×D
Storage temperature range	-30 °C ... +90 °C
Temperature range connector	-25 °C ... +90 °C
Temperature range fixed	-40 °C ... +80 °C
Temperature range moving	-25 °C ... +80 °C
Weight	0.100 kg/piece
Approvals	cULus
PU	1 Quantity

C-track chain properties

	Type B
Conduction properties (TYPE A+B+C)	PUR halogen free for extreme demands <ul style="list-style-type: none">• Very good chemical stability• Very resistant to oils and lubricants• Very high abrasion resistance• Halogen free• Silicone free, free of paint wetting impairment substances• Resistant to microbes and hydrolysis• Good UV stability

29.04.2017 – Subject to technical modification

Part-No. 443020

USA: LUTZE INC.

13330 South Ridge Drive • Charlotte, NC 28273, USA
Tel. +1 (704) 504-0222 • Fax +1 (704) 504-0223
www.lutze.com • info@lutze.com

United Kingdom: LÜTZE Ltd.

Unit 3, Sandy Hill Park
Sandy Way, Amington • GB-Tamworth, Staffs B77 4DU
Tel. +44 (0)1827 31333-0 • Fax +44 (0)1827 31333-2
www.lutze.com • sales.gb@lutze.co.uk



SYSTEMATIC TECHNOLOGY

Technical data sheet · Actuator sensor interface

Dimensions

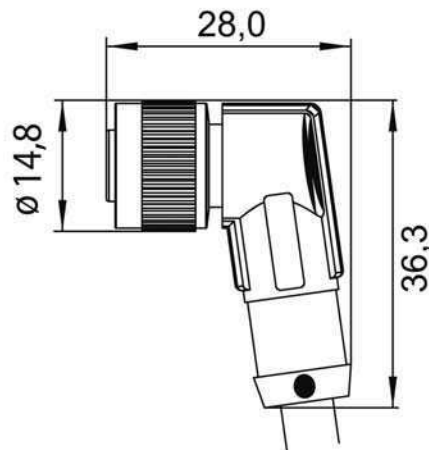

PIN assignment



Circuit diagram

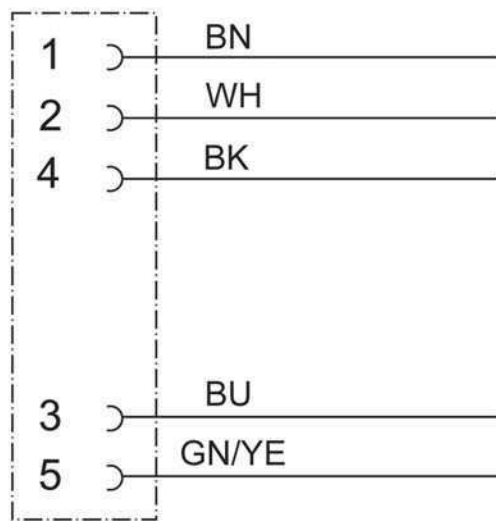

29.04.2017 – Subject to technical modification

Part-No. 443020

USA: LUTZE INC.

13330 South Ridge Drive · Charlotte, NC 28273, USA
Tel. +1 (704) 504-0222 · Fax +1 (704) 504-0223
www.lutze.com · info@lutze.com

United Kingdom: LÜTZE Ltd.

Unit 3, Sandy Hill Park
Sandy Way, Amington · GB-Tamworth, Staffs B77 4DU
Tel. +44 (0)1827 31333-0 · Fax +44 (0)1827 31333-2
www.lutze.com · sales.gb@lutze.co.uk

Symbols



Accessories	Part No.	Type	PU
Torque setting tool M 12	490091	DM-SET M12	1

29.04.2017 – Subject to technical modification

Part-No. 443020

USA: LUTZE INC.

13330 South Ridge Drive • Charlotte, NC 28273, USA
Tel. +1 (704) 504-0222 • Fax +1 (704) 504-0223
www.lutze.com • info@lutze.com

United Kingdom: LÜTZE Ltd.

Unit 3, Sandy Hill Park
Sandy Way, Amington • GB-Tamworth, Staffs B77 4DU
Tel. +44 (0)1827 31333-0 • Fax +44 (0)1827 31333-2
www.lutze.com • sales.gb@lutze.co.uk



SYSTEMATIC TECHNOLOGY