

Technical data sheet - Actuator sensor interface

M8 – cables



Identification	Type	KUW3-M8 10M PUR
	Part-No.	474100
Description	Female M8 angled with PUR cable, open end self-locking screwed connection c-track compatible, halogen free	
Technical data		
Rated voltage U_N	AC/DC 24 V	
Rated voltage max.	30 V	
Rated current	4 A	
Pole number	3	
Cable length	10.0 m	
General		
Form male 1	M 8 Female angle connector	
Form male 2	Line end open	
Nominal insulation voltage	100 V	
Test voltage	1500 V	
Degree of pollution	3	
Insulation resistance	> 1000 M Ω × km	

29.04.2017 – Subject to technical modification

Part-No. 474100

USA: LUTZE INC.

13330 South Ridge Drive • Charlotte, NC 28273, USA
Tel. +1 (704) 504-0222 • Fax +1 (704) 504-0223
www.lutze.com • info@lutze.com

United Kingdom: LÜTZE Ltd.

Unit 3, Sandy Hill Park
Sandy Way, Amington • GB-Tamworth, Staffs B77 4DU
Tel. +44 (0)1827 31333-0 • Fax +44 (0)1827 31333-2
www.lutze.com • sales.gb@lutze.co.uk



SYSTEMATIC TECHNOLOGY

Technical data sheet - Actuator sensor interface

Contact resistance	< 5 mΩ
Flamability according to UL 94	V0
Protection class	IP65/67/68
Housing material	TPU
Colour of the housing	black
Contact material	CuSn, gold-plated
Thread material	Zinc die-casting, nickel-plated
Material sealing ring	NBR
Mounting	Breakaway torque 0.2 Nm
Number of conductors/cross-section	3 × 0.25 mm ² (32 × 0.1)
Number of conductors	3
Conductor color	black, blue, brown
Jacket material	PUR
Jacket color	black
Conductor insulation	PP
Outer Ø	4.4 mm
Bending radius	10 × D
Minimum bending radius moving	10×D
Storage temperature range	-30 °C ... +90 °C
Temperature range connector	-25 °C ... +90 °C
Temperature range fixed	-40 °C ... +80 °C
Temperature range moving	-25 °C ... +80 °C
Weight	0.263 kg/piece
Approvals	cULus
PU	1 Quantity

C-track chain properties	Type B
Conduction properties (TYPE A+B+C)	PUR halogen free for extreme demands <ul style="list-style-type: none">• Very good chemical stability• Very resistant to oils and lubricants• Very high abrasion resistance• Halogen free• Silicone free, free of paint wetting impairment substances• Resistant to microbes and hydrolysis• Good UV stability

29.04.2017 – Subject to technical modification

Part-No. 474100

USA: LUTZE INC.

13330 South Ridge Drive • Charlotte, NC 28273, USA
Tel. +1 (704) 504-0222 • Fax +1 (704) 504-0223
www.lutze.com • info@lutze.com

United Kingdom: LÜTZE Ltd.

Unit 3, Sandy Hill Park
Sandy Way, Amington • GB-Tamworth, Staffs B77 4DU
Tel. +44 (0)1827 31333-0 • Fax +44 (0)1827 31333-2
www.lutze.com • sales.gb@lutze.co.uk



SYSTEMATIC TECHNOLOGY

Technical data sheet · Actuator sensor interface

Dimensions

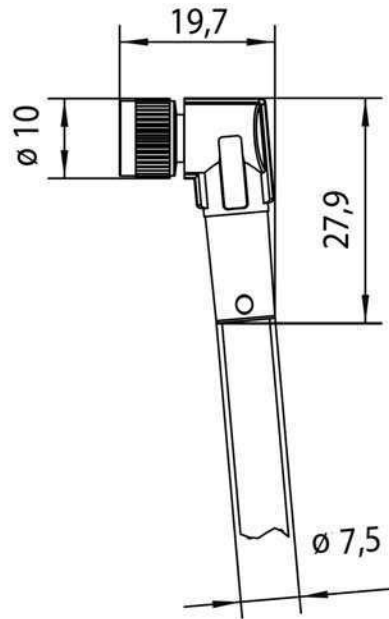

PIN assignment

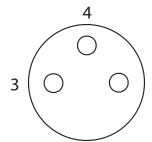

29.04.2017 – Subject to technical modification

Part-No. 474100

USA: LUTZE INC.

13330 South Ridge Drive · Charlotte, NC 28273, USA
Tel. +1 (704) 504-0222 · Fax +1 (704) 504-0223
www.lutze.com · info@lutze.com

United Kingdom: LÜTZE Ltd.

Unit 3, Sandy Hill Park
Sandy Way, Amington · GB-Tamworth, Staffs B77 4DU
Tel. +44 (0)1827 31333-0 · Fax +44 (0)1827 31333-2
www.lutze.com · sales.gb@lutze.co.uk

Technical data sheet · Actuator sensor interface

Circuit diagram

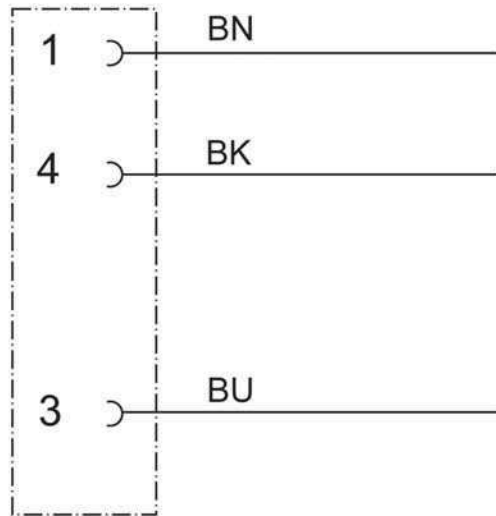

Symbols



Accessories

Torque setting tool M 8

Part No.

490090

Type

DM-SET M8

PU

1

29.04.2017 – Subject to technical modification

Part-No. 474100

USA: LUTZE INC.

13330 South Ridge Drive · Charlotte, NC 28273, USA
Tel. +1 (704) 504-0222 · Fax +1 (704) 504-0223
www.lutze.com · info@lutze.com

United Kingdom: LÜTZE Ltd.

Unit 3, Sandy Hill Park
Sandy Way, Amington · GB-Tamworth, Staffs B77 4DU
Tel. +44 (0)1827 31333-0 · Fax +44 (0)1827 31333-2
www.lutze.com · sales.gb@lutze.co.uk



SYSTEMATIC TECHNOLOGY